

INSTRUCTIONS

MODEL AV-1011-B

0 TO ± 100 VOLTS, 2 AMP, 1 MHz
GENERAL PURPOSE LAB PULSE GENERATOR
AND LASER DIODE DRIVER
WITH IEEE 488.2 AND RS-232 CONTROL

SERIAL NUMBER: _____

WARRANTY

Avtech Electrosystems Ltd. warrants products of its manufacture to be free from defects in material and workmanship under conditions of normal use. If, within one year after delivery to the original owner, and after prepaid return by the original owner, this Avtech product is found to be defective, Avtech shall at its option repair or replace said defective item. This warranty does not apply to units which have been disassembled, modified or subjected to conditions exceeding the applicable specifications or ratings. This warranty is the extent of the obligation assumed by Avtech with respect to this product and no other warranty or guarantee is either expressed or implied.

TECHNICAL SUPPORT

Phone: 613-226-5772 or 1-800-265-6681

Fax: 613-226-2802 or 1-800-561-1970

E-mail: info@avtechpulse.com

World Wide Web: <http://www.avtechpulse.com>

TABLE OF CONTENTS

WARRANTY.....	2
TECHNICAL SUPPORT.....	2
TABLE OF CONTENTS.....	3
INTRODUCTION.....	5
AVAILABLE OPTIONS.....	6
SPECIFICATIONS.....	7
EC DECLARATION OF CONFORMITY.....	8
INSTALLATION.....	9
VISUAL CHECK.....	9
POWER RATINGS.....	9
CONNECTION TO THE POWER SUPPLY.....	9
ENVIRONMENTAL CONDITIONS.....	9
LABVIEW DRIVERS.....	10
FUSES.....	11
AC FUSE REPLACEMENT.....	11
DC FUSE REPLACEMENT.....	12
FUSE RATINGS.....	12
FRONT PANEL CONTROLS.....	13
REAR PANEL CONTROLS.....	15
GENERAL INFORMATION.....	17
BASIC PULSE CONTROL.....	17
TRIGGER MODES.....	19
PULSE WIDTH MODES.....	19
GATING MODES.....	19
DUTY CYCLE CONSIDERATIONS.....	19
-OT OPTION.....	20
MINIMIZING WAVEFORM DISTORTIONS.....	21
OUTPUT IMPEDANCE.....	21
GENERATING LOW-VOLTAGE WAVEFORMS.....	21
USE 50 OHM TRANSMISSION LINES.....	21
USE LOW-INDUCTANCE LOADS.....	21

TYPICAL WAVEFORMS.....	23
MECHANICAL INFORMATION.....	26
TOP COVER REMOVAL.....	26
RACK MOUNTING.....	26
ELECTROMAGNETIC INTERFERENCE.....	26
MAINTENANCE.....	27
REGULAR MAINTENANCE.....	27
CLEANING.....	27
OPERATIONAL CHECK.....	28
PROGRAMMING YOUR PULSE GENERATOR.....	31
KEY PROGRAMMING COMMANDS.....	31
OTHER INFORMATION.....	35
APPLICATION NOTES.....	35
MANUAL FEEDBACK.....	35
PERFORMANCE CHECK SHEET.....	36

INTRODUCTION

The AV-1011-B is a high performance, GPIB and RS232-equipped instrument capable of 200 W peak pulse power at repetition rates up to 1 MHz. The output amplitude is variable up to ± 100 V into 50Ω . Pulse delay, advance and width are variable up to 1 ms. Rise and fall times are fixed at less than 10 ns. The AV-1011-B provides single or double pulse output and can be triggered or gated by an external source. A front-panel pushbutton can also be used to trigger the instrument. The output pulse width can be set to follow an input trigger pulse width and the output amplitude can be controlled by an externally applied 0 to +10 Volts DC control voltage.

The AV-1011-B features front panel keyboard and adjust knob control of the output pulse parameters along with a four line by 40 character back-lit LCD display of the output amplitude, polarity, pulse width, pulse repetition frequency, source resistance and delay. The instrument includes memory to store up to four complete instrument setups. The operator may use the front panel or the computer interface to store a complete "snapshot" of all key instrument settings, and recall this setup at a later time.

The source resistance can be set at either 2 or 50Ω . In the 2Ω setting, the output amplitude is variable from 0.5 to 100V. In the 50Ω setting the amplitude is variable from 0.3 to 50V to 50Ω , or to 100 Volts to a high impedance. The output amplitude can also be controlled externally by applying a 0 to +10V DC control voltage to a rear panel BNC connector.

The MOSFET output stages will safely withstand any combination of front panel control settings, output open or short circuits, and high duty cycles. An internal power supply monitor removes the power to the output stage for five seconds if an average power overload exists. After that time, the unit operates normally for one second, and if the overload condition persists, the power is cut again. This cycle repeats until the overload is removed. With a 50Ω load the unit will withstand duty cycles as high as 10% but with high impedance loads the duty cycle may be as high as 80%. The output stage will source up to 2.5 Amps (and will automatically shut down if the load current exceeds 2.5 Amps).

Application notes describing the use of the AV-1010 and AV-1011 families of pulse generators are available on the Avtech web site, <http://www.avtechpulse.com>.

This instrument is intended for use in research and development laboratories.

AVAILABLE OPTIONS

-BR Option: This optional feature allows a burst of 1-500 pulses to be generated in response to each trigger event.

-OT Option: This optional feature allows a $\pm 20V$ offset to be added to the output.

-R5 Option: This is the optional rack-mounting kit. The R5 rack-mount kit may also be ordered separately.

SPECIFICATIONS

Model:	AV-1011-B ¹
GPIB and RS-232 control ² :	Included
Rise time, fall time:	≤ 10 ns
Pulse output amplitude ³ : (R _L = 50 Ohms)	0 to 100 Volts (for Z _{out} = 2Ω) 0 to 50 Volts (for Z _{out} = 50Ω)
Pulse width ⁴ :	100 ns to 1 ms
Pulse repetition rate:	1 Hz to 1.0 MHz
Maximum duty cycle:	10% into 50Ω loads, 80% into >10kΩ loads
Output impedance:	2Ω or 50 Ω, switchable
Required load impedance:	≥ 50 Ω
Output polarity:	Positive or negative, switchable
Baseline offset: (Output voltage between pulses)	0V, fixed (Optional ⁵ : 0 to ±20V, 400 mA max)
Jitter:	Pulse width: ≤ 0.1 %, (typically ≤ 0.01 %), Delay/Advance, Period: ≤ 0.1%, + 0.5 ns
Pulse aberrations:	≤ ±0.5V ±5 % of amplitude
Double pulse spacing:	100 ns to 1 ms
Sync to main-output delay:	0 to ± 1 ms
Sync output:	+ 3 Volts, 50 ns (R _L > 1 kΩ)
Gated operation:	sync or async, active high or low, switchable
External trigger:	May be triggered by a signal with: Amp: +3 to +5V, Rep. Rate: ≤ 1 MHz, Pulse width: ≥ 50 ns
Minimum propagation delay, external trigger modes:	Advance: 200 ns Double pulse: 200 ns Delay: 200 ns PW _{IN} = PW _{OUT} : 120 ns
Output protection:	The output is protected against short circuits, open circuits, and high duty cycle
Connectors:	BNC female
Power source:	100 - 240 Volts, 50 - 60 Hz
Dimensions (H x W x D):	100 mm x 430 mm x 375 mm (3.9" x 17" x 14.8")
Chassis material, Weight:	Anodized aluminum with blue-gray plastic trim. ≤ 10 kg (22 lbs).
Operating temperature:	+ 10°C to + 50°C
Optional rack-mount kit:	Add "-R5" to model number to include 19" rack mount kit (see page 113)

- 1) -B suffix indicates GPIB equipped model. -C suffix indicates stand-alone lab instrument with internal clock and line powering but without GPIB.
- 2) Provides IEEE-488.2 GPIB and RS-232 control of amplitude, pulse width, polarity, PRF and delay. (See page 8).
- 3) The output amplitude may also be controlled by applying 0 to +10 V DC to a rear-panel BNC connector.
- 4) The output pulse width may also be controlled externally by applying a TTL-level trigger of the desired width to a rear-panel BNC connector (PW_{IN} = PW_{OUT} mode).
- 5) For adjustable (0 to ±20V) baseline offset, add -OT to the model number. When generating a pulse with positive amplitude, the offset plus amplitude must remain between 0 and +100V, and when generating a pulse with negative amplitude, the offset plus amplitude must remain between 0 and -100V.

EC DECLARATION OF CONFORMITY

We

Avtech Electrosystems Ltd.
P.O. Box 5120, LCD Merivale
Ottawa, Ontario
Canada K2C 3H4

declare that this pulse generator meets the intent of Directive 89/336/EEC for Electromagnetic Compatibility. Compliance pertains to the following specifications as listed in the official Journal of the European Communities:

EN 50081-1 Emission

EN 50082-1 Immunity

and that this pulse generator meets the intent of the Low Voltage Directive 72/23/EEC as amended by 93/68/EEC. Compliance pertains to the following specifications as listed in the official Journal of the European Communities:

EN 61010-1:2001 Safety requirements for electrical equipment for measurement, control, and laboratory use



INSTALLATION

VISUAL CHECK

After unpacking the instrument, examine to ensure that it has not been damaged in shipment. Visually inspect all connectors, knobs, liquid crystal displays (LCDs), and the handles. Confirm that a power cord, a GPIB cable, and two instrumentation manuals (this manual and the "Programming Manual for -B Instruments") are with the instrument. If the instrument has been damaged, file a claim immediately with the company that transported the instrument.

POWER RATINGS

This instrument is intended to operate from 100 - 240 V, 50 - 60 Hz.

The maximum power consumption is 90 Watts. Please see the "FUSES" section for information about the appropriate AC and DC fuses.

This instrument is an "Installation Category II" instrument, intended for operation from a normal single-phase supply.

CONNECTION TO THE POWER SUPPLY

An IEC-320 three-pronged recessed male socket is provided on the back panel for AC power connection to the instrument. One end of the detachable power cord that is supplied with the instrument plugs into this socket. The other end of the detachable power cord plugs into the local mains supply. Use only the cable supplied with the instrument. The mains supply must be earthed, and the cable used to connect the instrument to the mains supply must provide an earth connection. (The supplied cable does this.)

ENVIRONMENTAL CONDITIONS

This instrument is intended for use under the following conditions:

1. indoor use;
2. altitude up to 2 000 m;
3. temperature 5 °C to 40 °C;
4. maximum relative humidity 80 % for temperatures up to 31 °C decreasing linearly to 50 % relative humidity at 40 °C;
5. Mains supply voltage fluctuations up to ± 10 % of the nominal voltage;
6. no pollution or only dry, non-conductive pollution.

LABVIEW DRIVERS

A LabVIEW driver for this instrument is available for download on the Avtech web site, at <http://www.avtechpulse.com/labview>. A copy is also available in National Instruments' Instrument Driver Library at <http://www.natinst.com/>.

FUSES

This instrument contains four fuses. All are accessible from the rear-panel. Two protect the AC prime power input, and two protect the internal DC power supplies. The locations of the fuses on the rear panel are shown in the figure below:

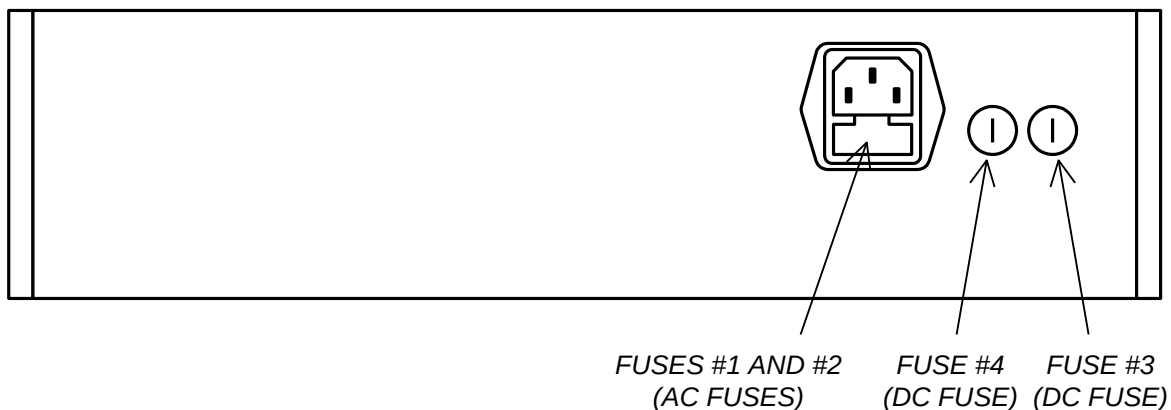

AC FUSE REPLACEMENT

To physically access the AC fuses, the power cord must be detached from the rear panel of the instrument. The fuse drawer may then be extracted using a small flat-head screwdriver, as shown below:

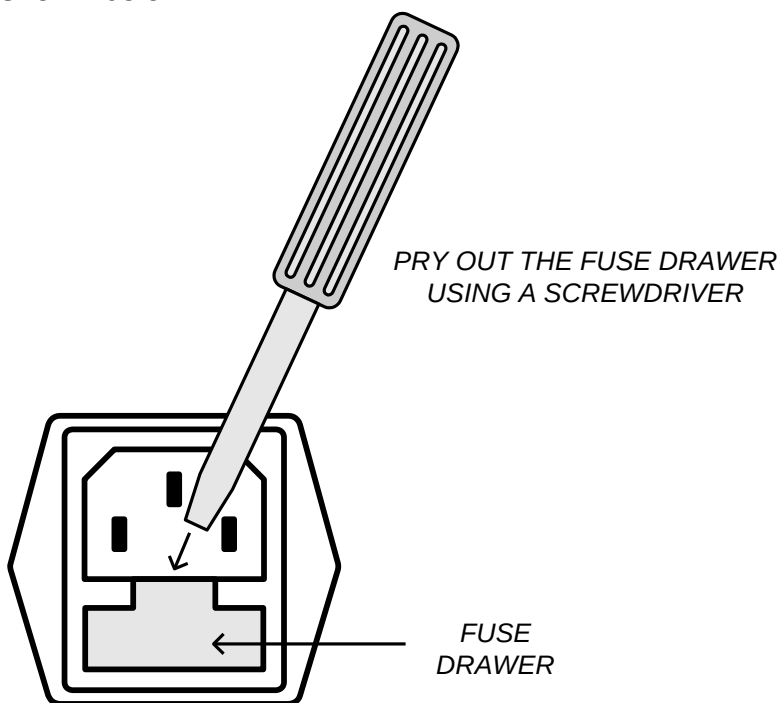

DC FUSE REPLACEMENT

The DC fuses may be replaced by inserting the tip of a flat-head screwdriver into the fuse holder slot, and rotating the slot counter-clockwise. The fuse and its carrier will then pop out.

FUSE RATINGS

The following table lists the required fuses:

Fuses	Nominal Mains Voltage	Rating	Case Size	Manufacturer's Part Number (Wickmann)	Distributor's Part Number (Digi-Key)
#1, #2 (AC)	115 V	0.8A, 250V, Time-Delay	5 x 20 mm	1950800000	WK5046-ND
	230 V	0.5A, 250V, Time-Delay	5 x 20 mm	1950500000	WK5041-ND
#3 (DC)	N/A	3.15A, 250V, Time-Delay	5 x 20 mm	1951315000	WK5124-ND
#4 (DC)	N/A	2.0A, 250V, Time-Delay	5 x 20 mm	1951200000	WK5057-ND

The fuse manufacturer is Wickmann (<http://www.wickmann.com/>).

Replacement fuses may be easily obtained from Digi-Key (<http://www.digikey.com/>) and other distributors.

FRONT PANEL CONTROLS

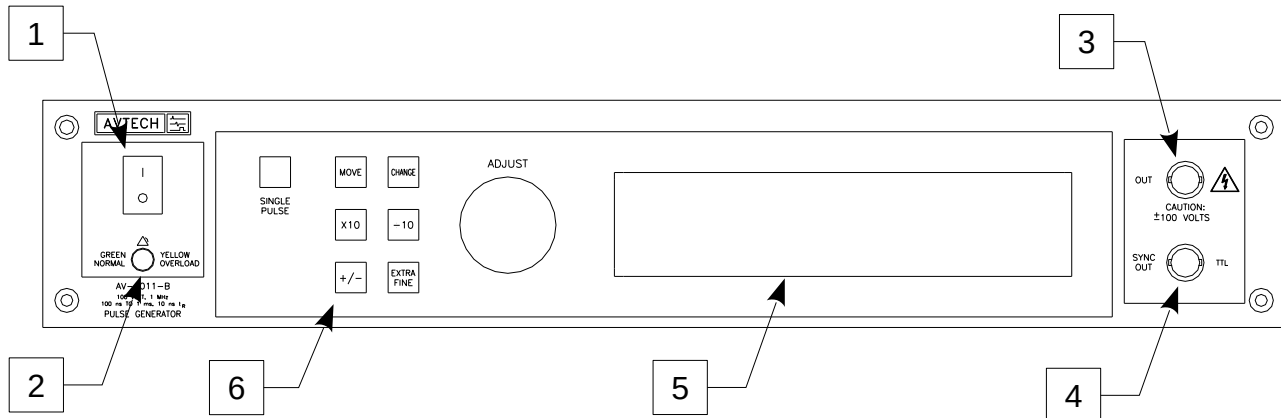

1. **POWER Switch**. This is the main power switch. When turning the instrument on, there may be a delay of several seconds before the instrument appears to respond.
2. **OVERLOAD Indicator**. When the instrument is powered, this indicator is normally green, indicating normal operation. If this indicator is yellow, an internal automatic overload protection circuit has been tripped. If the unit is overloaded (by operating at an exceedingly high duty cycle or by operating into a very low impedance), the protective circuit will disable the output of the instrument and turn the indicator light yellow. The light will stay yellow (i.e. output disabled) for about 5 seconds after which the instrument will attempt to re-enable the output (i.e. light green) for about 1 second. If the overload condition persists, the output will be disabled again (i.e. light yellow) for another 5 seconds. If the overload condition has been removed, the instrument will resume normal operation.

This overload indicator may flash yellow briefly at start-up. This is not a cause for concern.

Note that the output stage will safely withstand a short-circuited load condition.

3. **OUT CONNECTOR**. This BNC connector provides the main output signal, into load impedances of 50Ω or higher.

 **Caution:** Voltages as high as ±100V may be present on the center conductor of this output connector. Avoid touching this conductor. Connect to this connector using standard coaxial cable, to ensure that the center conductor is not exposed.

4. **SYNC OUT**. This connector supplies a SYNC output that can be used to trigger other equipment, particularly oscilloscopes. This signal leads (or lags) the main output by a duration set by the "DELAY" controls and has an approximate amplitude of +3 Volts to $R_L > 1K$ with a pulse width of approximately 50 ns.

5. LIQUID CRYSTAL DISPLAY (LCD). This LCD is used in conjunction with the keypad to change the instrument settings. Normally, the main menu is displayed, which lists the key adjustable parameters and their current values. The "Programming Manual for -B Instruments" describes the menus and submenus in detail.
6. KEYPAD.

Control Name	Function
MOVE	This moves the arrow pointer on the display.
CHANGE	This is used to enter the submenu, or to select the operating mode, pointed to by the arrow pointer.
×10	If one of the adjustable numeric parameters is displayed, this increases the setting by a factor of ten.
÷10	If one of the adjustable numeric parameters is displayed, this decreases the setting by a factor of ten.
+/-	If one of the adjustable numeric parameters is displayed, and this parameter can be both positive or negative, this changes the sign of the parameter.
EXTRA FINE	This changes the step size of the ADJUST knob. In the extra-fine mode, the step size is twenty times finer than in the normal mode. This button switches between the two step sizes.
ADJUST	This large knob adjusts the value of any displayed numeric adjustable values, such as frequency, pulse width, etc. The adjust step size is set by the "EXTRA FINE" button. When the main menu is displayed, this knob can be used to move the arrow pointer.

REAR PANEL CONTROLS

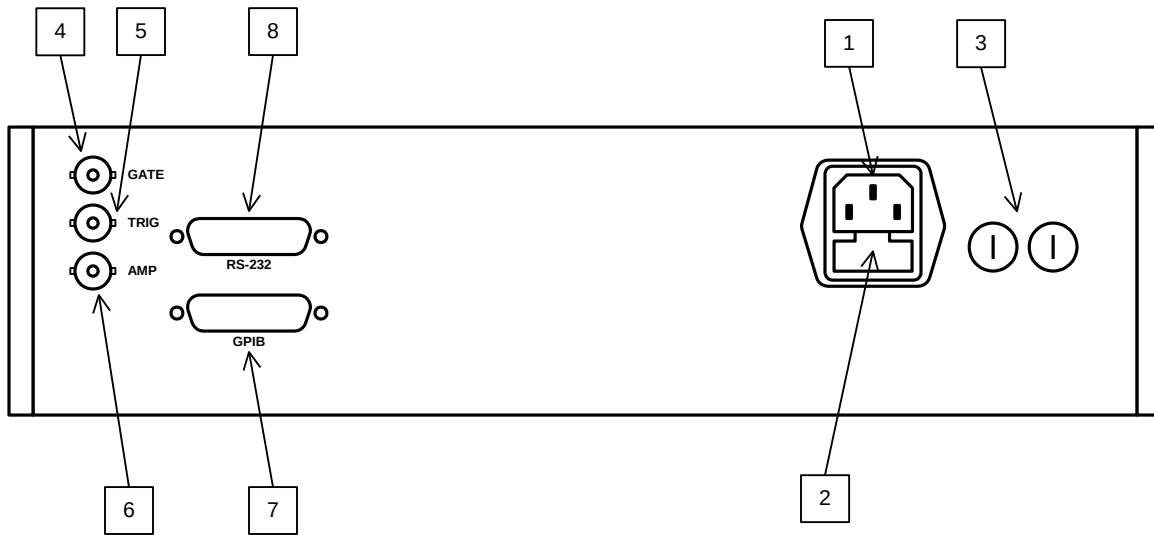

1. AC POWER INPUT. An IEC-320 C14 three-pronged recessed male socket is provided on the back panel for AC power connection to the instrument. One end of the detachable power cord that is supplied with the instrument plugs into this socket.
2. AC FUSE DRAWER. The two fuses that protect the AC input are located in this drawer. Please see the “FUSES” section of this manual for more information.
3. DC FUSES. These two fuses protect the internal DC power supplies. Please see the “FUSES” sections of this manual for more information.
4. GATE. This TTL-level (0 and +5V) logic input can be used to gate the triggering of the instrument. This input can be either active high or active low, depending on the front panel settings or programming commands. (The instrument triggers normally when this input is unconnected). When set to active high mode, this input is pulled-down to ground by a 1 k Ω resistor. When set to active low mode, this input is pulled-up to +5V by a 1 k Ω resistor.
5. TRIG. This TTL-level (0 and +5V) logic input can be used to trigger the instrument, if the instrument is set to triggering externally. The instrument triggers on the rising edge of this input. The input impedance of this input is 1 k Ω . (Depending on the length of cable attached to this input, and the source driving it, it may be desirable to add a coaxial 50 Ohm terminator to this input to provide a proper transmission line termination. The Pasternack (www.pasternack.com) PE6008-50 BNC feed-thru 50 Ohm terminator is suggested for this purpose.)

When triggering externally, the instrument can be set such that the output pulse width tracks the pulse width on this input, or the output pulse width can be set

independently.

6. AMP Connector. The output amplitude can be set to track the voltage on this input. Zero Volts in corresponds to zero amplitude output, and +10V in corresponds to maximum amplitude out. This mode is activated by selecting "Ext Control" on the front-panel amplitude menu, or with the "source:voltage external" command.
7. GPIB Connector. A standard GPIB cable can be attached to this connector to allow the instrument to be computer-controlled. See the "Programming Manual for -B Instruments" for more details on GPIB control.
8. RS-232 Connector. A standard serial cable with a 25-pin male connector can be attached to this connector to allow the instrument to be computer-controlled. See the "Programming Manual for -B Instruments" for more details on RS-232 control.

GENERAL INFORMATION

BASIC PULSE CONTROL

This instrument can be triggered by its own internal clock or by an external TTL trigger signal. In either case, two output channels respond to the trigger: OUT and SYNC. The OUT channel is the signal that is applied to the load. Its amplitude and pulse width are variable. The SYNC pulse is a fixed-width TTL-level reference pulse used to trigger oscilloscopes or other measurement systems. When the delay is set to a positive value the SYNC pulse precedes the OUT pulse. When the delay is set to a negative value the SYNC pulse follows the OUT pulse.

These pulses are illustrated below, assuming internal triggering and a positive delay:

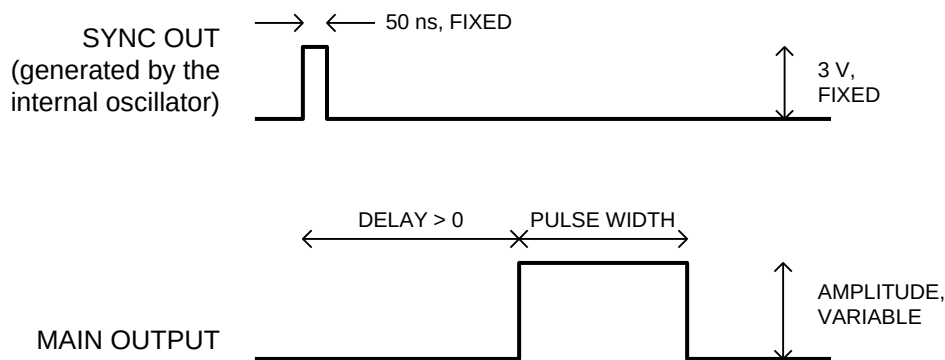

Figure A

If the delay is negative, the order of the SYNC and OUT pulses is reversed:

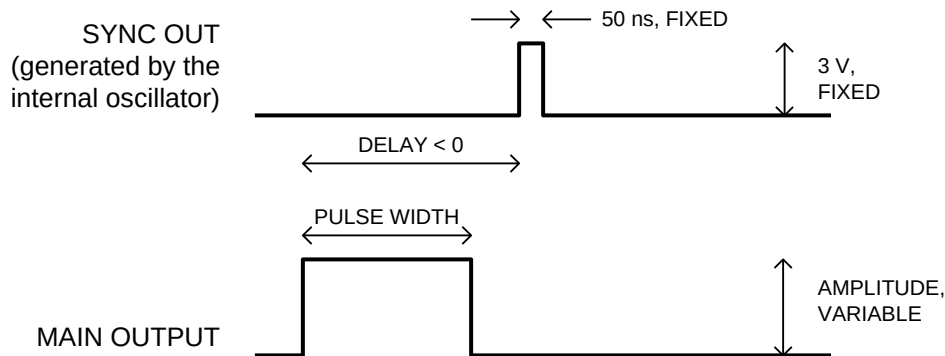

Figure B

The next figure illustrates the relationship between the signal when an external TTL-level trigger is used:

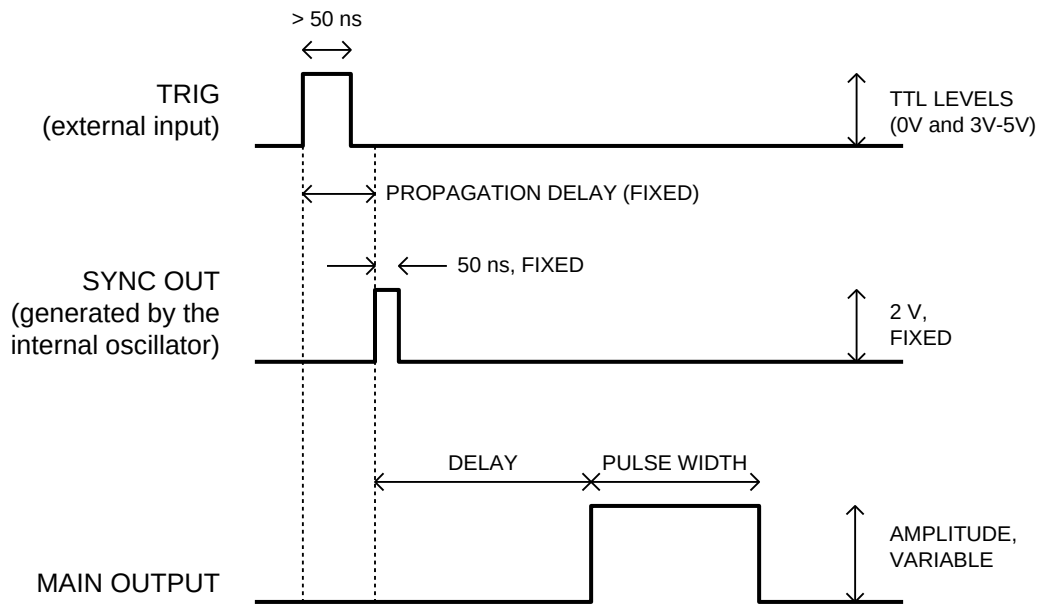

Figure C

As before, if the delay is negative, the order of the SYNC and OUT pulses is reversed.

The last figure illustrates the relationship between the signal when an external TTL-level trigger is used in the $PW_{IN}=PW_{OUT}$ mode. In this case, the output pulse width equals the external trigger's pulse width (approximately), and the delay circuit is bypassed:

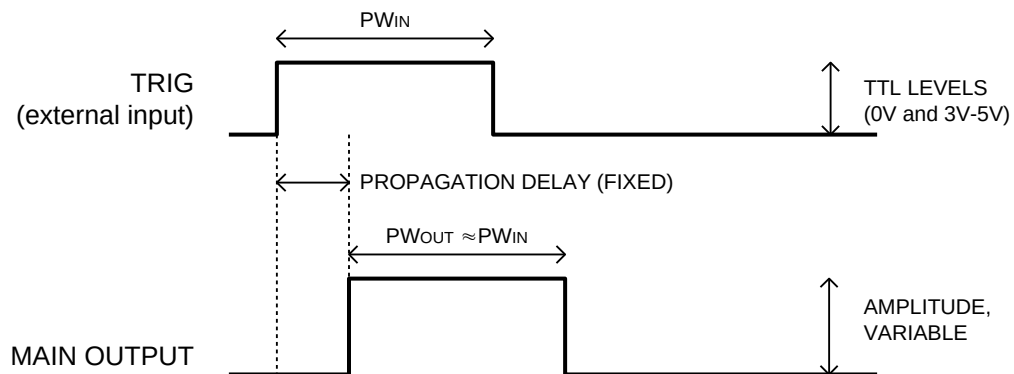

Figure D

The delay, pulse width, and frequency (when in the internal mode), of the OUT pulse can be varied with front panel controls or via the GPIB or RS-232 computer interfaces.

TRIGGER MODES

This instrument has four trigger modes:

- Internal Trigger: the instrument controls the trigger frequency, and generates the clock internally.
- External Trigger: the instrument is triggered by an external TTL-level clock on the back-panel TRIG connector.
- Manual Trigger: the instrument is triggered by the front-panel “SINGLE PULSE” pushbutton.
- Hold Trigger: the instrument is set to not trigger at all.

These modes can be selected using the front panel trigger menu, or by using the appropriate programming commands. (See the “Programming Manual for -B Instruments” for more details.)

PULSE WIDTH MODES

This instrument has two pulse width modes:

- Normal: the instrument controls the output pulse width.
- $PW_{IN}=PW_{OUT}$: the output pulse width equals the pulse width of the trigger signal on the “TRIG” connector. The instrument must be in the external trigger mode.

These modes can be selected using the front panel pulse width menu, or by using the appropriate programming commands. (See the “Programming Manual for -B Instruments” for more details.)

GATING MODES

Triggering can be suppressed by a TTL-level signal on the rear-panel GATE connector. The instrument can be set to stop triggering when this input high or low, using the front-panel gate menu or the appropriate programming commands. This input can also be set to act synchronously or asynchronously. When set to asynchronous mode, the GATE will disable the output immediately. Output pulses may be truncated. When set to synchronous mode, the output will complete the full pulse width if the output is high, and then stop triggering. No pulses are truncated in this mode.

DUTY CYCLE CONSIDERATIONS

When operating into a 50 Ohm load, the output duty cycle (i.e., pulse width divided by pulse period) is limited to 10%.

However, if the load impedance is 10 k Ω or greater, the output duty cycle can as high as 80%. To achieve this extended duty cycle, the instrument must be set to high-impedance-load mode. To activate this mode, use the front-panel "Load" menu to switch the load setting to "> 10 k Ω ", or use the "output:load 10000" computer command (see the programming manual for details).

-OT OPTION

Instruments with the "-OT" offset option can add a $\pm 20\text{V}$ offset to the output ($\pm 10\text{V}$ if the output impedance and the load impedance are both 50 Ω). This is subject to the limitation that when generating a pulse with positive amplitude, the peak voltage (offset plus amplitude) must remain above zero, and when generating a pulse with negative amplitude, the offset plus amplitude must remain below zero. This is illustrated below:

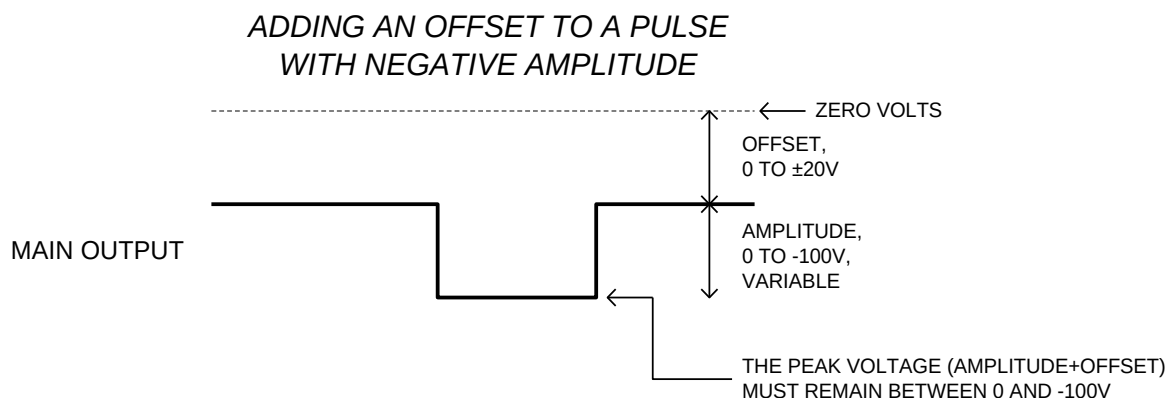
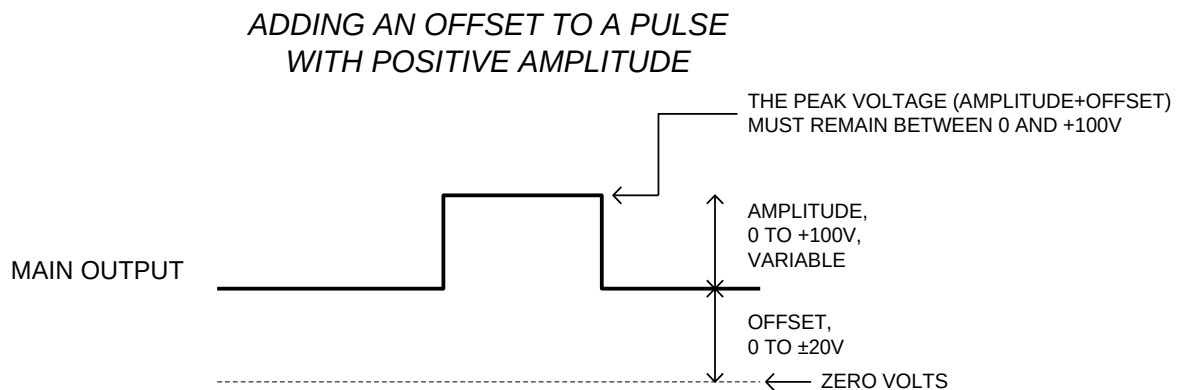

MINIMIZING WAVEFORM DISTORTIONS

OUTPUT IMPEDANCE

The output impedance of the AV-1011-B can be set at 2Ω or 50Ω using the front panel controls (or GPIB/RS-232 commands).

When driving a high impedance load (i.e., $R_L \gg 50\Omega$), the output impedance should always be set to 50Ω . This will minimize waveform ringing and transmission line reflections, without adversely affecting the pulse amplitude.

When driving a 50Ω load, it is also highly desirable to set the output impedance to 50Ω . However, the output impedance and the load resistance will cause a resistive voltage-divider effect, reducing the output amplitude at the load by a factor of two. Thus, the 50Ω output impedance can only be used to generate amplitudes of 0 to $\pm 50V$. Similarly, for units with the -OT option, the maximum offset at the load is reduced from $\pm 20V$ to $\pm 10V$.

GENERATING LOW-VOLTAGE WAVEFORMS

When generating low-voltage waveforms, the output waveforms will have much less distortion (i.e. ringing) if the output impedance is set to 50Ω . As noted above, if the pulse generator is driving a 50Ω load, this will result in a resistive-divider effect – for instance, to obtain the best possible +5V waveform into a 50Ω load, set the pulse generator output impedance to 50Ω , and the amplitude to +10V.

USE 50 OHM TRANSMISSION LINES

Connect the load to the pulse generator with 50Ω transmission lines (e.g. RG-58 or RG-174 cable). If possible, use a 50Ω load. If the actual device under test has a high impedance, consider adding a 50Ω termination in parallel with the load to properly terminate the transmission line.

Setting the pulse generator output impedance to 50Ω will “back-match” the transmission line, resulting in improved performance.

USE LOW-INDUCTANCE LOADS

Lenz’s Law predicts that for an inductive voltage spike will be generated when the current through an inductance changes. Specifically, $V_{\text{SPIKE}} = L \times di_{\text{LOAD}}/dt$, where L is the inductance, i_{LOAD} is the load current change, and t is time. For this reason, it is important to keep any parasitic in the load low. This means keeping wiring short, and

using low inductance components. In particular, wire-wound resistors should be avoided.

TYPICAL WAVEFORMS

Figure 1 shows typical output waveforms with the pulse generator amplitude set at +100V, the pulse width at 500 ns, and the output impedance set to 2Ω . The pulse generator is connected to a 50Ω load through an 8" length of RG-174 cable.

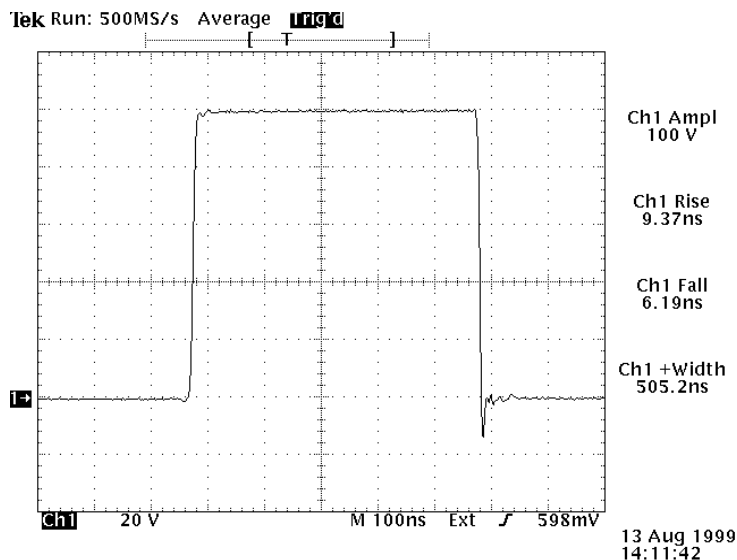

Figure 1 (20V/div, 100 ns/div)

Figure 2 shows the results with similar settings, except that the output impedance has been set to 50Ω . As a result, the amplitude at the load has fallen by a factor of two, and the waveform shows less distortion on the very fast falling edge.

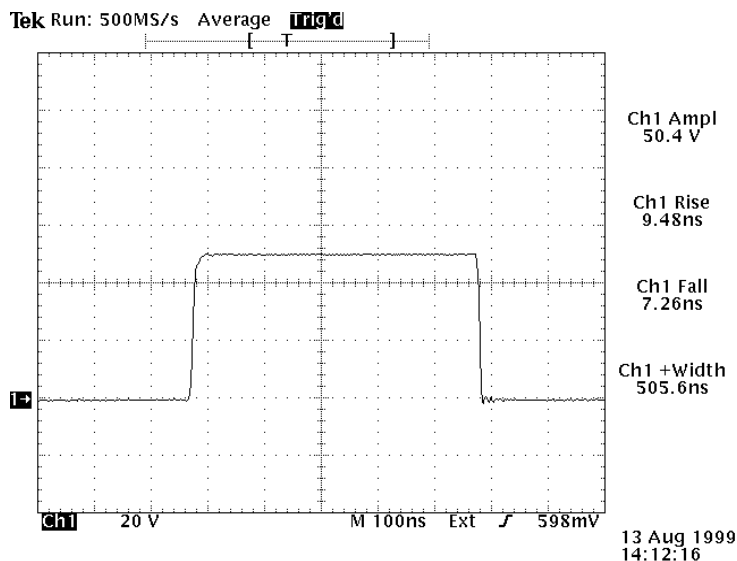

Figure 2 (20V/div, 100 ns/div)

Figures 3 and 4 show operation at low voltages. Figure 3 shows typical output waveforms with the pulse generator amplitude set at +5V, the pulse width at 500 ns,

and the output impedance set to 2Ω . The pulse generator is again connected to a 50Ω load through an 8' length of RG-174 cable. At this low amplitude, the waveform is dominated by undesirable ringing.

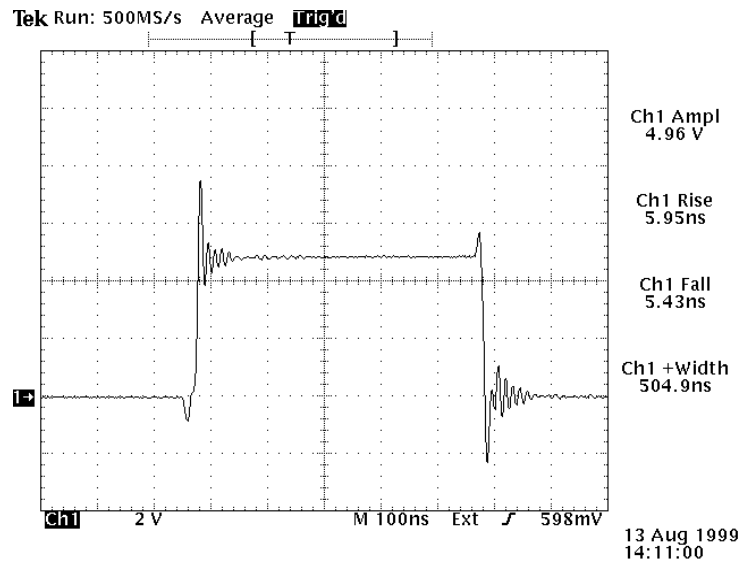

Figure 3 (2V/div, 100 ns/div)

This situation can be remedied by setting the output impedance to 50Ω , and doubling the set amplitude to +10V to compensate for the voltage-divider effect. Figure 4 shows the vastly improved waveform that results.

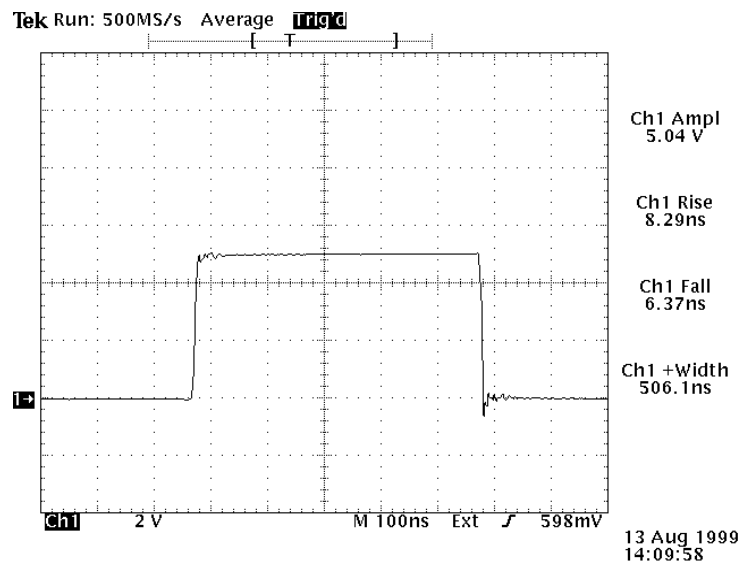

Figure 4 (2V/div, 100 ns/div)

Figure 5 shows the output of an instrument with the -OT option, with amplitude set at +80V, the offset at +20V, the pulse width at 500 ns, and the output impedance at 2Ω .

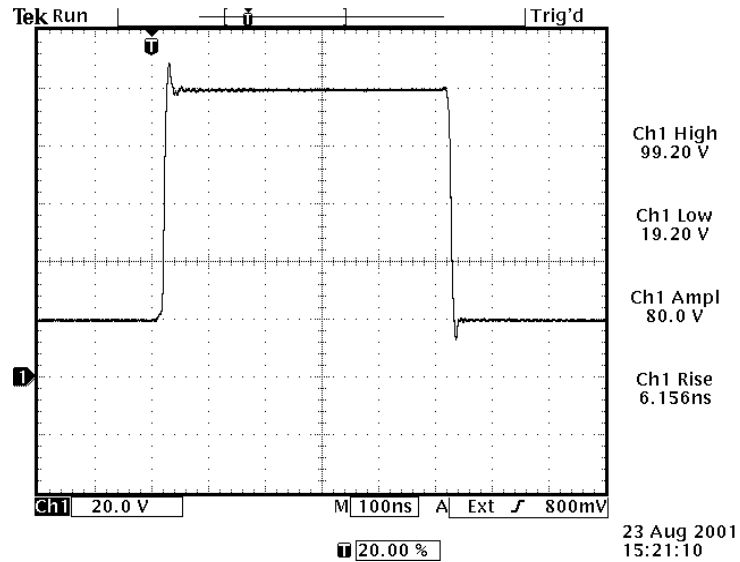

Figure 5 (20V/div, 100 ns/div)

Figure 6 also shows the output of an instrument with the -OT option, with amplitude set at +80V, the offset at +20V, and the pulse width at 500 ns, but the output impedance is set at 50Ω . The amplitude and offset at the load fall by a factor of two, compared to Figure 5.

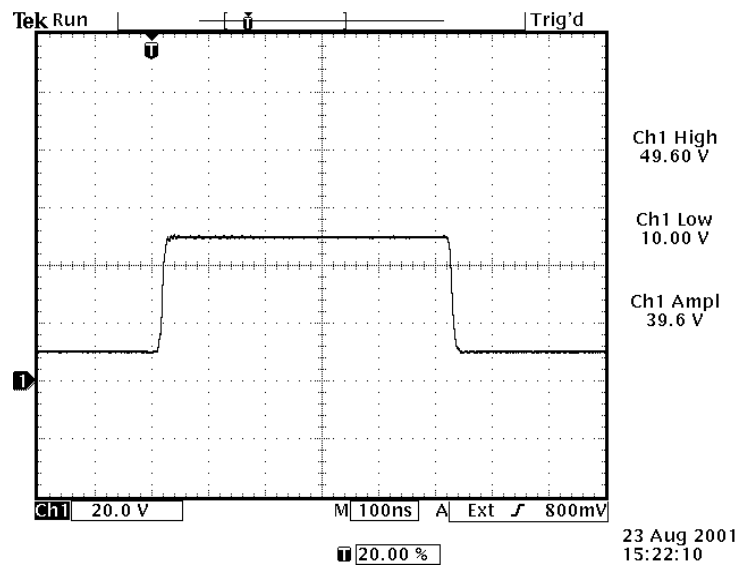

Figure 6 (20V/div, 100 ns/div)

MECHANICAL INFORMATION

TOP COVER REMOVAL

If necessary, the interior of the instrument may be accessed by removing the four Phillips screws on the top panel. With the four screws removed, the top cover may be slid back (and off).

Always disconnect the power cord before opening the instrument.

There are no user-adjustable internal circuits. For repairs other than fuse replacement, please contact Avtech (info@avtechpulse.com) to arrange for the instrument to be returned to the factory for repair.

⚠ Caution: High voltages are present inside the instrument during normal operation. Do not operate the instrument with the cover removed.

RACK MOUNTING

A rack mounting kit is available. The -R5 rack mount kit may be installed after first removing the one Phillips screw on the side panel adjacent to the front handle.

ELECTROMAGNETIC INTERFERENCE

To prevent electromagnetic interference with other equipment, all used outputs should be connected to shielded 50Ω loads using shielded 50Ω coaxial cables. Unused outputs should be terminated with shielded 50Ω BNC terminators or with shielded BNC dust caps, to prevent unintentional electromagnetic radiation. All cords and cables should be less than 3m in length.

MAINTENANCE

REGULAR MAINTENANCE

This instrument does not require any regular maintenance.

On occasion, one or more of the four rear-panel fuses may require replacement. All fuses can be accessed from the rear panel. See the “FUSES” section for details.

CLEANING

If desired, the interior of the instrument may be cleaned using compressed air to dislodge any accumulated dust. (See the “TOP COVER REMOVAL” section for instructions on accessing the interior.) No other cleaning is recommended.

OPERATIONAL CHECK

This section describes a sequence to confirm the basic operation of the instrument. It should be performed after receiving the instrument. It is a useful learning exercise as well.

Before proceeding with this procedure, finish reading this instruction manual thoroughly. Then read the "Local Control" section of the "Programming Manual for -B Instruments" thoroughly. The "Local Control" section describes the front panel controls used in this operational check - in particular, the MOVE, CHANGE, and ADJUST controls.

1. Connect a cable from the SYNC OUT connector to the TRIG input of an oscilloscope. Connect a 10W (or higher) 50 Ω load to the OUT connector and place the scope probe across this load. Set the oscilloscope to trigger externally with the vertical setting at 5 Volts/div and the horizontal setting at 1 μ s/div.
2. Turn on the AV-1011-B. The main menu will appear on the LCD.
3. To set the AV-1011-B to trigger from the internal clock at a PRF of 10 kHz:
 - a) The arrow pointer should be pointing at the frequency menu item. If it is not, press the MOVE button until it is.
 - b) Press the CHANGE button. The frequency submenu will appear. Rotate the ADJUST knob until the frequency is set at 10 kHz.
 - c) The arrow pointer should be pointing at the "Internal" choice. If it is not, press MOVE until it is.
 - d) Press CHANGE to return to the main menu.
4. To set the delay to 1 μ s:
 - a) Press the MOVE button until the arrow pointer is pointing at the delay menu item.
 - b) Press the CHANGE button. The delay submenu will appear. Rotate the ADJUST knob until the delay is set at 1 μ s.
 - c) The arrow pointer should be pointing at the "Normal" choice. If it is not, press MOVE until it is.
 - d) Press CHANGE to return to the main menu.

5. To set the pulse width to 1 μs :
 - a) Press the MOVE button until the arrow pointer is pointing at the pulse width menu item.
 - b) Press the CHANGE button. The pulse width submenu will appear. Rotate the ADJUST knob until the pulse width is set at 1 μs .
 - c) The arrow pointer should be pointing at the "Normal" choice. If it is not, press MOVE until it is.
 - d) Press CHANGE to return to the main menu.
6. The main menu display should show that the output impedance (Z_{OUT}) is set at 2Ω , and the load impedance (R_L) is set at 50Ω . If they are different, change the settings.
7. At this point, nothing should appear on the oscilloscope.
8. To enable the output:
 - a) Press the MOVE button until the arrow pointer is pointing at the output menu item.
 - b) Press the CHANGE button. The output submenu will appear.
 - c) Press MOVE until the arrow pointer is pointing at the "ON" choice.
 - d) Press CHANGE to return to the main menu.
9. To change the output amplitude:
 - a) Press the MOVE button until the arrow pointer is pointing at the amplitude menu item.
 - b) Press the CHANGE button. The amplitude submenu will appear. Rotate the ADJUST knob until the amplitude is set at 10V.
 - c) Observe the oscilloscope. You should see 1 μs wide, 10V pulses.
 - d) Rotate the ADJUST knob. The amplitude as seen on the oscilloscope should vary. Set it at 20V.
 - e) Press CHANGE to return to the main menu.
10. Try varying the pulse width, by repeating step (5). As you rotate the ADJUST knob, the pulse width on the oscilloscope will change. It should agree with the displayed value. Stay below 10% duty cycle.

11. Go to the output impedance menu, and set the output impedance (Z_{OUT}) to $50\ \Omega$. Return to the main menu. If a $50\ \Omega$ load is attached to the output (see step 1) the amplitude should fall by a factor of 2, to 10V.
12. To change the output amplitude polarity:
 - a) Press the MOVE button until the arrow pointer is pointing at the amplitude menu item.
 - b) Press the CHANGE button. The amplitude submenu will appear.
 - c) Press the "+/-" button. The amplitude as seen on the oscilloscope should become negative.
 - d) Press CHANGE to return to the main menu.

This completes the operational check.

PROGRAMMING YOUR PULSE GENERATOR

KEY PROGRAMMING COMMANDS

The “Programming Manual for -B Instruments” describes in detail how to connect the pulse generator to your computer, and the programming commands themselves. A large number of commands are available; however, normally you will only need a few of these. Here is a basic sample sequence of commands that might be sent to the instrument after power-up, using the internal trigger source:

```
*rst                (resets the instrument)
trigger:source internal (selects internal triggering)
frequency 1000 Hz    (sets the frequency to 1000 Hz)
pulse:width 10 us    (sets the pulse width to 10 us)
pulse:delay 1 us     (sets the delay to 1 us)
output:load 50       (tells the instrument that you are using a 50Ω load.
                    This affects the duty cycle limit. The only other allowed
                    setting is output:load 10000.)
output:impedance 2   (sets the output impedance to 2Ω. The only other allowed
                    setting is output:impedance 50.)
output on            (turns on the output)
volt 50              (sets the amplitude to 50 V)
volt:low 10          (FOR -OT OPTION ONLY: sets the offset to +10 V)
```

For triggering a single event, this sequence would be more appropriate:

```
*rst                (resets the instrument)
trigger:source hold  (turns off all triggering)
pulse:width 10 us    (sets the pulse width to 10 us)
pulse:delay 1 us     (sets the delay to 1 us)
output:load 50       (tells the instrument that you are using a 50Ω load.
                    This affects the duty cycle limit. The only other allowed
                    setting is output:load 10000.)
output:impedance 2   (sets the output impedance to 2Ω. The only other allowed
                    setting is output:impedance 50.)
output on            (turns on the output)
volt 50              (sets the amplitude to 50 V)
volt:low 10          (FOR -OT OPTION ONLY: sets the offset to +10 V)
trigger:source immediate (generates a single non-repetitive trigger event)
trigger:source hold  (turns off all triggering)
output off           (turns off both outputs)
```

To trigger from an external TTL pulse, use:

```
*rst                (resets the instrument)
trigger:source external (selects external triggering)
```

pulse:width 10 us	(sets the pulse width to 10 us)
pulse:delay 1 us	(sets the delay to 1 us)
output:load 50	(tells the instrument that you are using a 50Ω load. This affects the duty cycle limit. The only other allowed setting is output:load 10000.)
output:impedance 2	(sets the output impedance to 2Ω. The only other allowed setting is output:impedance 50.)
output on	(turns on the output)
volt 50	(sets the amplitude to 50 V)
volt:low 10	(FOR -OT OPTION ONLY: sets the offset to +10 V)

To set the output pulse width to track the trigger pulse width in external mode, use:

*rst	(resets the instrument)
trigger:source external	(selects external triggering)
pulse:width in	($PW_{OUT} = PW_{IN}$)
output:load 50	(tells the instrument that you are using a 50Ω load. This affects the duty cycle limit. The only other allowed setting is output:load 10000.)
output:impedance 2	(sets the output impedance to 2Ω. The only other allowed setting is output:impedance 50.)
output on	(turns on the output)
volt 50	(sets the amplitude to 50 V)
volt:low 10	(FOR -OT OPTION ONLY: sets the offset to +10 V)

These commands will satisfy 90% of your programming needs.

ALL PROGRAMMING COMMANDS

For more advanced programmers, a complete list of the available commands is given below. These commands are described in detail in the “Programming Manual for -B Instruments”. (Note: this manual also includes some commands that are not implemented in this instrument. They can be ignored.)

<u>Keyword</u>	<u>Parameter</u>	<u>Notes</u>
LOCAL		
OUTPut:		
:LOAD	50 10000	
:[STATe]	<boolean value>	
:IMPedance	<numeric value>	
:PROTection		
:TRIPped?		[query only]
REMOTE		
[SOURce]:		
:FREQuency		
[:CW FIXed]	<numeric value>	
[SOURce]:		

:PULSe		
:PERiod	<numeric value>	
:WIDTh	<numeric value> IN	
:DCYClE	<numeric value>	
:HOLD	WIDTh DCYClE	
:DELay	<numeric value>	
:DOUBle		
[:STATE]	<boolean value>	
:DELay	<numeric value>	
:GATE		
:TYPE	ASYNc SYNc	
:LEVel	HIGH LOW	
[SOURce]:		
:VOLTage		
[:LEVel]		
[:IMMediate]		
[:AMPLitude]	<numeric value> EXTernal	
:LOW	<numeric value>	[for -OT option only]
:PROTectiOn		
:TRIPped?		[query only]
STATUS:		
:OPERation		
:[EVENT]?		[query only, always returns "0"]
:CONDitiOn?		[query only, always returns "0"]
:ENABle	<numeric value>	[implemented but not useful]
:QUESTiOnable		
:[EVENT]?		[query only, always returns "0"]
:CONDitiOn?		[query only, always returns "0"]
:ENABle	<numeric value>	[implemented but not useful]
SYSTem:		
:COMMunicate		
:GPIB		
:ADDReSS	<numeric value>	
:SERial		
:CONTRol		
:RTS	ON IBFull RFR	
:[RECeive]		
:BAUD	1200 2400 4800 9600	
:BITS	7 8	
:ECHO	<boolean value>	
:PARity		
:[TYPE]	EVEN ODD NONE	
:SBITS	1 2	
:ERRor		
:[NEXT]?		[query only]
:COUNT?		[query only]
:VERSion?		[query only]
TRIGger:		
:SOURce	INTernal EXTernal MANual HOLD IMMEDIATE	[no query form]
*CLS		
*ESE	<numeric value>	
*ESR?		[query only]
*IDN?		[query only]
*OPC		
*SAV	0 1 2 3	[no query form]
*RCL	0 1 2 3	[no query form]
*RST		[no query form]
*SRE	<numeric value>	

*STB?
*TST?
*WAI

[query only]
[query only]
[no query form]

OTHER INFORMATION

APPLICATION NOTES

Application notes are available on the Avtech web site, at <http://www.avtechpulse.com/appnote>.

MANUAL FEEDBACK

Please report any errors or omissions in this manual, or suggestions for improvement, to info@avtechpulse.com. Thanks!

PERFORMANCE CHECK SHEET