

INSTRUCTIONS

MODEL AV-1015-C

0 TO ± 50 VOLTS, 1 AMP,

10 ns RISE & FALL TIME

LAB PULSE GENERATOR AND LASER DIODE DRIVER

SERIAL NUMBER: _____

WARRANTY

Avtech Electrosystems Ltd. warrants products of its manufacture to be free from defects in material and workmanship under conditions of normal use. If, within one year after delivery to the original owner, and after prepaid return by the original owner, this Avtech product is found to be defective, Avtech shall at its option repair or replace said defective item. This warranty does not apply to units which have been disassembled, modified or subjected to conditions exceeding the applicable specifications or ratings. This warranty is the extent of the obligation assumed by Avtech with respect to this product and no other warranty or guarantee is either expressed or implied.

TECHNICAL SUPPORT

Phone: 613-226-5772 or 1-800-265-6681

Fax: 613-226-2802 or 1-800-561-1970

E-mail: info@avtechpulse.com

World Wide Web: <http://www.avtechpulse.com>

TABLE OF CONTENTS

WARRANTY	2
TECHNICAL SUPPORT	2
TABLE OF CONTENTS	3
INTRODUCTION	5
SPECIFICATIONS	6
EC DECLARATION OF CONFORMITY	7
INSTALLATION	8
VISUAL CHECK	8
LINE VOLTAGE SELECTION	8
CONNECTION TO THE POWER SUPPLY	9
POWER RATINGS	10
ENVIRONMENTAL CONDITIONS	10
FUSES	11
AC FUSE REPLACEMENT	11
DC FUSE REPLACEMENT	12
FUSE RATINGS	12
FRONT PANEL CONTROLS	13
MAINFRAME REAR PANEL CONTROLS	17
GENERAL INFORMATION	18
BASIC TEST ARRANGEMENT	18
BASIC PULSE CONTROL	18
MINIMIZING WAVEFORM DISTORTIONS	20
OUTPUT IMPEDANCE	20
GENERATING LOW-VOLTAGE WAVEFORMS	20
USE 50Ω TRANSMISSION LINES	20
USE LOW-INDUCTANCE LOADS	20
OPERATIONAL CHECK	22
TYPICAL WAVEFORMS	24
MECHANICAL INFORMATION	26
TOP COVER REMOVAL	26
RACK MOUNTING	26

ELECTROMAGNETIC INTERFERENCE	26
<i>MAINTENANCE</i>	27
REGULAR MAINTENANCE	27
CLEANING	27
<i>PERFORMANCE CHECK SHEET</i>	28

Manual Reference: /filesserver1/officefiles/instructword/av-1015/OBS/av-1015-c, edition 2.doc, created April 11, 2003

INTRODUCTION

The AV-1015-C is a high performance instrument capable generating amplitudes up to ± 50 V into 50Ω at repetition rates up to 10 MHz. Pulse widths are variable from 20 ns to 10 ms. Rise and fall times are fixed at less than 10 ns. The AV-1015-C provides single or double pulse output and can be triggered or gated by an external source. A front-panel pushbutton can also be used to trigger the instrument. The output pulse width can be set to follow an input trigger pulse width and the output amplitude can be controlled by an externally applied 0 to +10 Volts DC control voltage.

The output impedance depends on the amplitude range selected. For the ± 50 V ranges, the output impedance is approximately 2Ω . In the lower ranges (± 25 V and below), the output impedance is 50Ω .

The MOSFET output stages will safely withstand any combination of front panel control settings, output open or short circuits, and high duty cycles. An internal power supply monitor removes the power to the output stage for five seconds if an average power overload exists. After that time, the unit operates normally for one second, and if the overload condition persists, the power is cut again. This cycle repeats until the overload is removed. With a 50Ω load the unit will withstand duty cycles as high as 25%. The output stage will source up to 1.25 Amps (and will automatically shut down if the load current exceeds 1.25 Amps).

Application notes describing the use of the AV-1010 and AV-1015 families of pulse generators are available on the Avtech web site, <http://www.avtechpulse.com>. In particular, application notes describing techniques for driving laser diodes, and for using pulse transformers to boost the output current, are presented.

SPECIFICATIONS

Model:	AV-1015-C
Output amplitude:	0.3V to 50V, into 50 Ω
Output polarity:	+ or -, switch-selectable
Rise time, fall time:	≤ 10 ns
Pulse aberrations:	$\leq \pm 5$ % of amplitude
Pulse width:	20 ns to 10 ms
Jitter:	Pulse width: $\leq .1\%$, typically $<.01\%$ Delay/Advance, Period: $\leq .1\%$, +0.5 ns
Pulse repetition rate:	10 Hz to 10 MHz
Maximum duty cycle:	25% for 50 Ω loads 80% for ≥ 10 k Ω loads
Output impedance:	0.75, 2.5, 7.5, and 25V ranges: 50 Ω 50V ranges: 2 Ω
Double pulse spacing:	100 ns to 10 ms
Sync delay:	0 to ± 10 ms (between SYNC and main output)
Sync output:	+3 Volts, 50 ns ($R_L > 1$ k Ω)
Gated operation: (TTL logic levels)	triggering stops when gate is TTL-low (0V)
External trigger:	Mode A: TTL (0 - 5V), > 50 ns width Mode B: TTL (0 - 5V), $PW_{IN} = PW_{OUT}$ Includes single-pulse pushbutton
Minimum propagation delay, external trigger modes:	Advance: 140ns Double pulse: 150ns Delay: 200ns $PW_{IN} = PW_{OUT}$: 70ns
Protected against:	open and short circuits, high duty cycle
Connectors:	BNC female
Power source:	120/240 Volts, ± 10 % (switchable), 50 - 60 Hz
Dimensions (H x W x D):	100 mm x 430 mm x 375 mm (3.9" x 17" x 14.8")
Weight:	≤ 10 kg (22 lbs)
Chassis material:	Aluminum. Anodized aluminum front panel with cast aluminum side panels (with blue-gray plastic trim) and aluminum top and bottom panels with blue-gray plastic trim.
Operating temperature:	+ 10° C to + 50° C
Accessories furnished:	one detachable 6' power cord, one operation-maintenance manual
Option available:	19" rack mount kit (-R5)

EC DECLARATION OF CONFORMITY

We

Avtech Electrosystems Ltd.
P.O. Box 5120, LCD Merivale
Ottawa, Ontario
Canada K2C 3H4

declare that this pulse generator meets the intent of Directive 89/336/EEC for Electromagnetic Compatibility. Compliance pertains to the following specifications as listed in the official Journal of the European Communities:

EN 50081-1 Emission

EN 50082-1 Immunity

and that this pulse generator meets the intent of the Low Voltage Directive 72/23/EEC as amended by 93/68/EEC. Compliance pertains to the following specifications as listed in the official Journal of the European Communities:

EN 61010-1:2001 Safety requirements for electrical equipment for measurement, control, and laboratory use



INSTALLATION

VISUAL CHECK

After unpacking the instrument mainframe and the output module(s), examine to ensure that they have not been damaged in shipment. Visually inspect all connectors, knobs, liquid crystal displays (LCDs), and the handles. Confirm that a power cord, a GPIB cable, and two instrumentation manuals (this manual and the "OP1B Interface Programming Manual") are with the instrument. If the instrument has been damaged, file a claim immediately with the company that transported the instrument.

LINE VOLTAGE SELECTION

Examine the rear of the instrument. There will be a power-entry module consisting of a male power receptacle, the main power switch, and a fuse holder / voltage selector. Confirm that the voltage selector is in the correct orientation. For AC line voltages of $115\text{V} \pm 10\%$, 50 - 60 Hz, the power selector card should be installed so that the "115" marking is visible from the rear of the instrument. For AC line voltages of $230\text{V} \pm 10\%$, 50 - 60 Hz, the power selector card should be installed so that the "230" marking is visible from the rear of the instrument. The two possible settings are shown below:

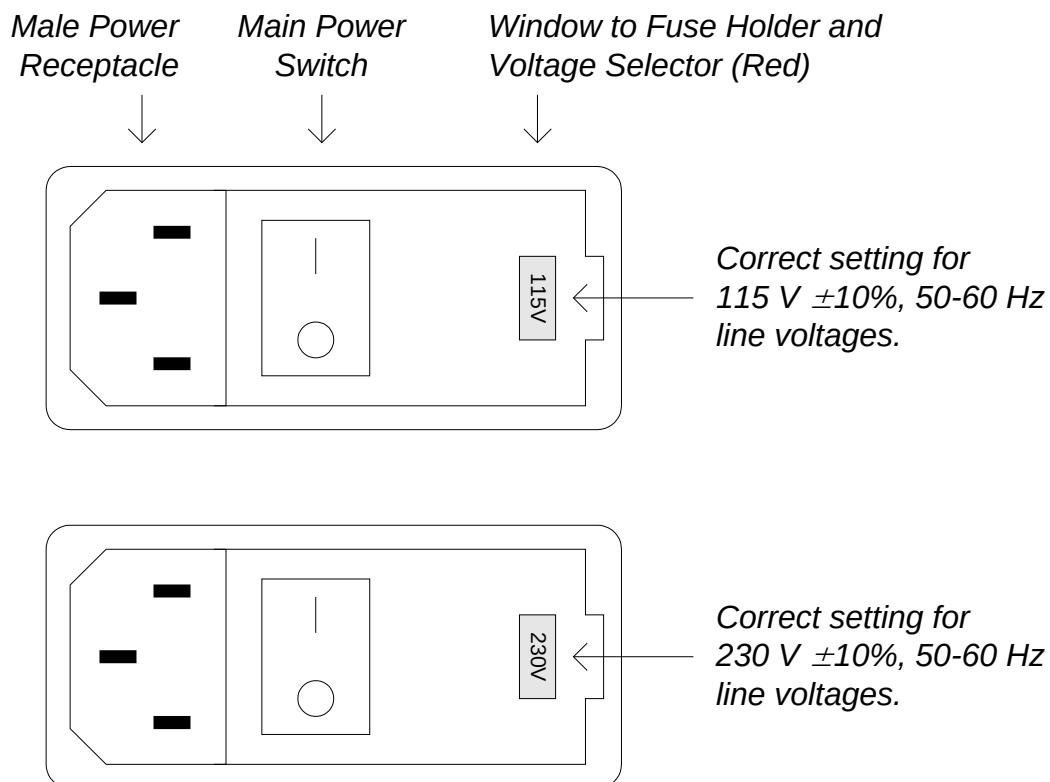

If the voltage selector is not set for to proper voltage, use a small flat-head screwdriver to pry open the voltage selector panel, as shown below:

Fuse Holder and Voltage Selector Panel.

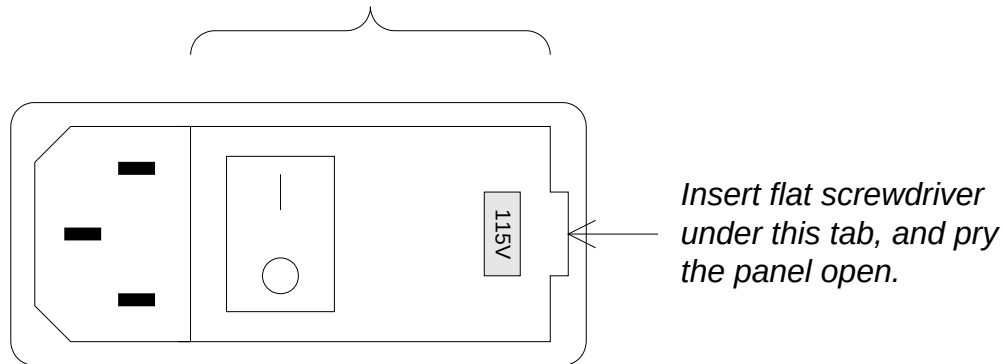

*Fuse Holder and Voltage Selector.
After opening the panel, the red plastic
fuse holder and voltage selector will be
visible.*

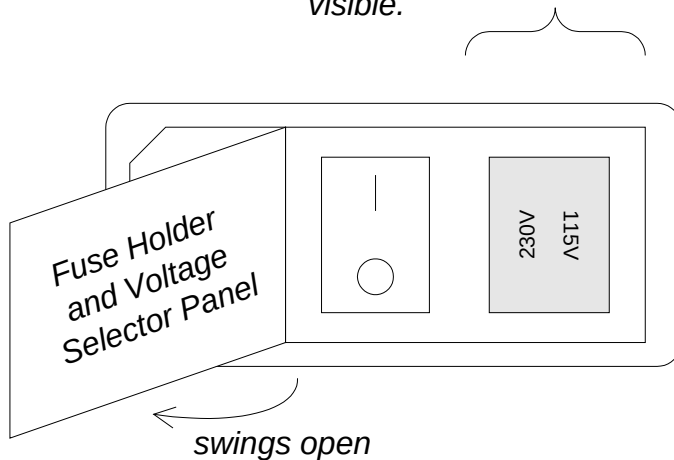

Once the panel is open, the red fuse holder / voltage selector should be visible. To change the voltage setting, pull out the red fuse holder / voltage selector and rotate it so that the proper voltage marking will shown through the panel window. Re-install the red fuse holder / voltage selector, and close the panel.

CONNECTION TO THE POWER SUPPLY

An IEC-320 three-pronged recessed male socket is provided on the back panel for AC power connection to the instrument. One end of the detachable power cord that is

supplied with the instrument plugs into this socket. The other end of the detachable power cord plugs into the local mains supply. Use only the cable supplied with the instrument. The mains supply must be earthed, and the cable used to connect the instrument to the mains supply must provide an earth connection. (The supplied cable does this.)

POWER RATINGS

This instrument is intended to operate from 115 / 230 V \pm 10%, 50-60 Hz. The maximum power consumption is 74 W. This instrument is an "Installation Category II" instrument, intended for operation from a normal single-phase supply.

ENVIRONMENTAL CONDITIONS

This instrument is intended for use under the following conditions:

- a) indoor use;
- b) altitude up to 2 000 m;
- c) temperature 5 °C to 40 °C;
- d) maximum relative humidity 80 % for temperatures up to 31 °C decreasing linearly to 50 % relative humidity at 40 °C;
- e) Mains supply voltage fluctuations up to \pm 10 % of the nominal voltage;
- f) no pollution or only dry, non-conductive pollution.

FUSES

This instrument contains four fuses. All are accessible from the rear-panel. Two protect the AC prime power input, and two protect the internal DC power supplies. The locations of the fuses on the rear panel are shown in the figure below:

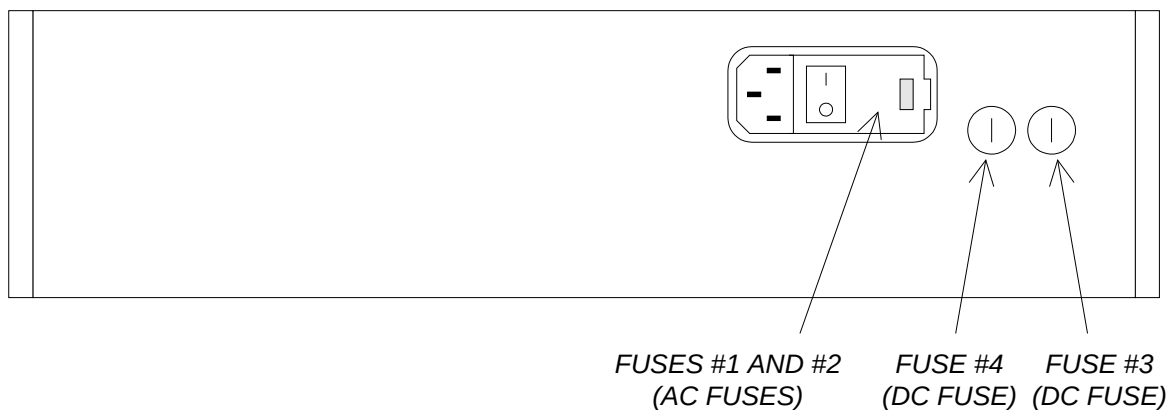

AC FUSE REPLACEMENT

The red fuse holder / voltage selector described in the previous section contains two fuses. One protects the AC “Line” input, and one protects the AC “Neutral” input. To replace the AC fuses, pull out the red fuse holder / voltage selector (as described in the previous section). The location of the two identical 5 mm x 20 mm fuses is shown below:

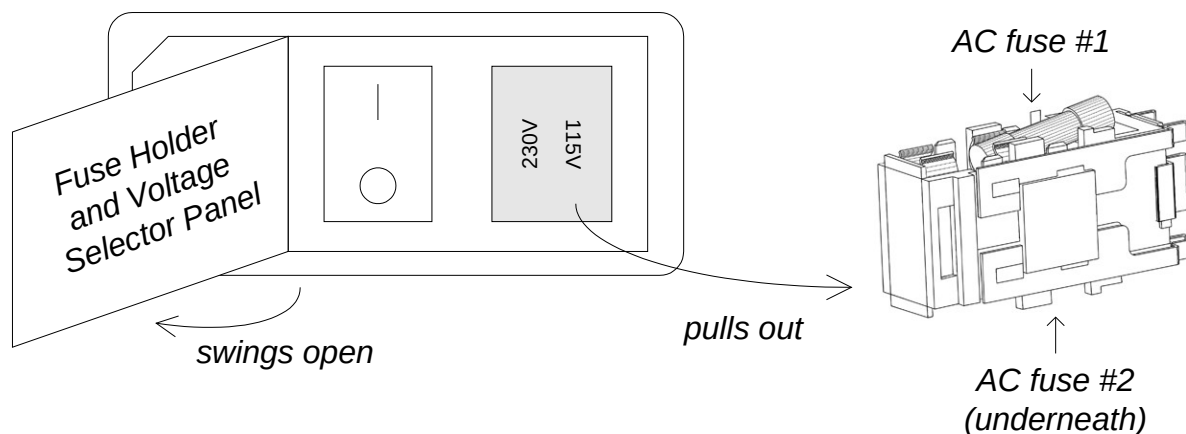

DC FUSE REPLACEMENT

The DC fuses may be replaced by inserting the tip of a flat-head screwdriver into the fuseholder slot, and rotating the slot counter-clockwise. The fuse and its carrier will then pop out.

FUSE RATINGS

The following table lists the required fuses:

Fuse	Mains Voltage	Rating	Case Size	Manufacturer's Part Number (Wickmann)	Distributor's Part Number (Digi-Key)
#1 (AC)	115 V	0.5A, 250V, Time-Delay	5 x 20 mm	1950500000	WK5041-ND
	230 V	0.8A, 250V, Time-Delay	5 x 20 mm	1950800000	WK5046-ND
#2 (AC)	115 V	0.5A, 250V, Time-Delay	5 x 20 mm	1950500000	WK5041-ND
	230 V	0.8A, 250V, Time-Delay	5 x 20 mm	1950800000	WK5046-ND
#3 (DC)	115/230V	1.6A, 250V, Time-Delay	5 x 20 mm	1951160000	WK5053-ND
#4 (DC)	115/230V	1.6A, 250V, Time-Delay	5 x 20 mm	1951160000	WK5053-ND

The fuse manufacturer is Wickmann (<http://www.wickmann.com/>).

Replacement fuses may be easily obtained from Digi-Key (<http://www.digikey.com/>) and other distributors.

FRONT PANEL CONTROLS

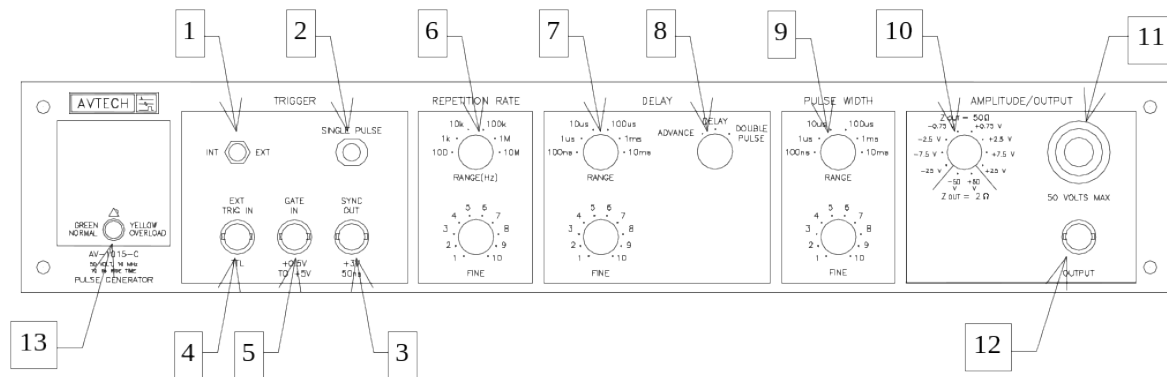

- 1) INT/EXT Switch. This switch sets the triggering mode for the instrument. When set to the “EXT” position, the instrument is triggered by externally-generated TTL-level (0 and 3-5V logic levels) pulses on the “EXT TRIG” input connector (item 4), or by pressing the “SINGLE PULSE” pushbutton (item 2). When set to the “INT” position, the instrument is triggered by the internal oscillator, whose frequency is controlled by the “REPETITION RATE” controls (item 6).
- 2) SINGLE PULSE Push Button. The "SINGLE PULSE" push button will trigger the instrument manually for one cycle of output, when the "INT/EXT" switch is in the "EXT" position. Otherwise, the push button has no effect.
- 3) SYNC OUT. When the "INT/EXT" switch is in the "INT" position, this connector supplies a SYNC output that can be used to trigger other equipment, particularly oscilloscopes. This signal leads, or lags, the main output by a duration set by the "DELAY" controls (items 7 and 8) and has an approximate amplitude of +3 Volts to $R_L > 1K$ with a pulse width of approximately 50 ns.
- 4) TRIG IN. When the "INT/EXT" switch is in the "EXT" position, the external trigger (standard TTL logic levels of 0 and +3 to +5 Volts, pulse width >50 ns) is applied to this connector. This input presents a high impedance (> 10 k Ω). Depending on the length of cable attached to this input, and the source driving it, it may be desirable to add a coaxial 50 Ohm terminator to this input to provide a proper transmission line termination. The Pasternack (www.pasternack.com) PE6008-50 BNC feed-thru 50 Ohm terminator is suggested for this purpose.
- 5) GATE Input. The GATE input will suppress the triggering of the instrument if taken to a TTL LOW level (i.e. 0V). If it is left open or taken to a TTL HIGH (i.e., between 3V and 5V), normal triggering will occur. ($R_{IN} > 1K$).

- 6) REPETITION RATE Controls. The rotary switch marked "RANGE" selects the pulse repetition rate for the internally triggered mode. The vernier (labeled "MIN- MAX") provides continuously variable control of each range. There are six ranges and the instrument is set to the rate indicated on the front panel when the vernier is in the "MAX" position. The ranges are:

10 Hz - 100 Hz
 100 Hz - 1 kHz
 1 kHz - 10 kHz
 10 kHz - 100 kHz
 100 kHz - 1.0 MHz
 1.0 MHz - 10 MHz

- 7) DELAY Controls. The rotary switch selects one of six ranges and the vernier provides continuously variable control of each range. The instrument is set to the delay indicated on the front panel when the vernier is in the "MAX" position. The six ranges are:

20 ns - 100 ns
 100 ns - 1 us
 1 us - 10 us
 10 us - 100 us
 100 us - 1 ms
 1 ms - 10 ms

- 8) ADVANCE, DELAY, DOUBLE PULSE. With this three-position switch in the ADVANCE position, the leading edge of the output pulse precedes the leading edge of the SYNC output. When in the DELAY position, the leading edge of the SYNC output precedes the leading edge of the main output. When in the DOUBLE PULSE position, the main output provides two successive output pulses having a separation determined by the DELAY controls (item 7).

- 9) PULSE WIDTH Controls. The rotary switch selects one of six ranges and the vernier provides continuously variable control of each range. The instrument is set to the pulse width indicated on the front panel when the vernier is in the "MAX" position. The six ranges are:

20 ns - 100 ns
 100 ns - 1 us
 1 us - 10 us
 10 us - 100 us
 100 us - 1 ms
 1 ms - 10 ms

- 10) AMPLITUDE RANGE Switch. The rotary switch selects one of ten ranges and the vernier (item 11) provides continuously variable control of each range. The

instrument is set to the amplitude indicated on the front panel when the vernier is in the "MAX" position. The range setting also affects the output impedance. The output impedance is nominally 2 Ohms in the highest ranges, and 50 Ohms in the lower ranges. The ten ranges are:

- 0 to -50 Volts ($Z_{OUT} = 2 \text{ Ohm}$)
- 0 to -25 Volts ($Z_{OUT} = 50 \text{ Ohm}$)
- 0 to -7.5 Volts ($Z_{OUT} = 50 \text{ Ohm}$)
- 0 to -2.5 Volts ($Z_{OUT} = 50 \text{ Ohm}$)
- 0 to -0.75 Volt ($Z_{OUT} = 50 \text{ Ohm}$)
- 0 to +0.75 Volts ($Z_{OUT} = 50 \text{ Ohm}$)
- 0 to +2.5 Volt ($Z_{OUT} = 50 \text{ Ohm}$)
- 0 to +7.5 Volts ($Z_{OUT} = 50 \text{ Ohm}$)
- 0 to +25 Volts ($Z_{OUT} = 50 \text{ Ohm}$)
- 0 to +50 Volts ($Z_{OUT} = 2 \text{ Ohm}$)

11) AMPLITUDE FINE. The ten-turn amplitude vernier provides continuously variable control of the peak amplitude of the main output from 0 Volts to the maximum set by the range switch (item 10).

12) OUT. BNC connector provides output to load impedance of 50 Ohms or higher.



Caution: Voltages as high as $\pm 50\text{V}$ may be present on the center conductor of this output connector. Avoid touching this conductor. Connect to this connector using standard coaxial cable, to ensure that the center conductor is not exposed.

13) OVERLOAD Indicator. When the instrument is powered, this indicator is normally green, indicating normal operation. If this indicator is yellow, an internal automatic overload protection circuit has been tripped. If the unit is overloaded (by operating at an exceedingly high duty cycle or by operating into a very low impedance), the protective circuit will disable the output of the instrument and turn the indicator light yellow. The light will stay yellow (i.e. output disabled) for about 5 seconds after which the instrument will attempt to re-enable the output (i.e. light green) for about 1 second. If the overload condition persists, the output will be disabled again (i.e. light yellow) for another 5 seconds. If the overload condition has been removed, the instrument will resume normal operation.

This overload indicator may flash yellow briefly at start-up. This is not a cause for concern.

Note that the output stage will safely withstand a short-circuited load condition.

Overload conditions may be removed by:

- a) Reducing PRF (i.e. switch to a lower range)
- b) Reducing pulse width (i.e. switch to a lower range)

- c) Removing output low load impedance (if any)
- d) Reducing the output amplitude (i.e. switch to a lower range)

MAINFRAME REAR PANEL CONTROLS

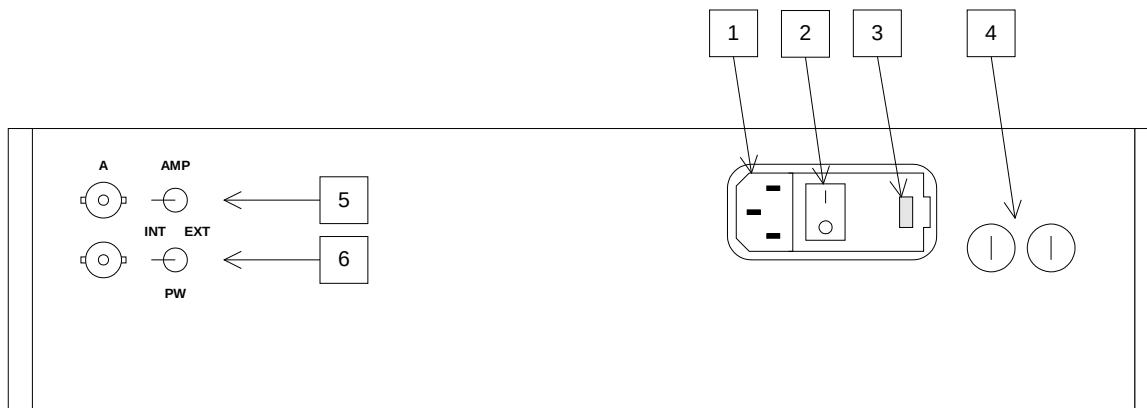

1. AC POWER INPUT. An IEC-320 three-pronged recessed male socket is provided on the back panel for AC power connection to the instrument. One end of the detachable power cord that is supplied with the instrument plugs into this socket.
2. POWER SWITCH. This is the main power switch. The instrument should be positioned so that the switch is accessible.
3. FUSE HOLDER / VOLTAGE SELECTOR. This red plastic module must be installed so that the marked voltage equals the AC line voltage. This module also contains two fuses that protect the AC inputs. Please see the “LINE VOLTAGE SELECTION” and “FUSES” sections of this manual for more information.
4. DC FUSES. These two fuses protect the internal DC power supplies. Please see the “FUSES” sections of this manual for more information.
5. EA SWITCH AND INPUT. When this switch is set to the “INT” position, the output amplitude is controlled by the front-panel amplitude dial. When this switch is set to the “EXT” position, the output amplitude is controlled by the voltage applied to the “A” BNC connector. 0V in corresponds to zero amplitude, and +10V DC in corresponds to maximum amplitude (+250V). The input impedance of the “A” connector is $> 10 \text{ k}\Omega$.
6. PW INPUT. The pulse generator may be triggered externally in a $PW_{OUT} = PW_{IN}$ mode by setting the switch in the EXT position and applying a TTL level pulse with the desired pulse width to the A connector. The front-panel timing controls are disabled in this mode.

GENERAL INFORMATION

BASIC TEST ARRANGEMENT

The AV-1015-C should normally be connected as shown below:

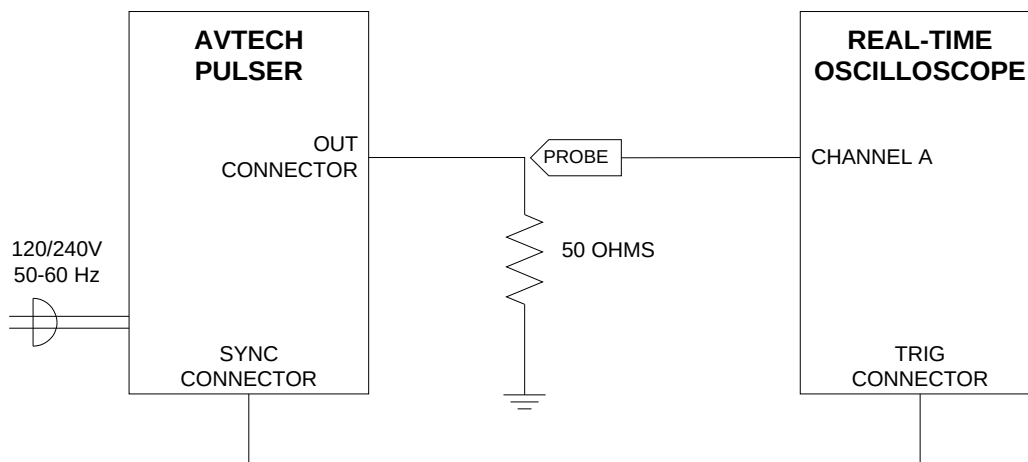

BASIC PULSE CONTROL

This instrument can be triggered by its own internal clock or by an external TTL trigger signal. When triggered internally, two mainframe output channels respond to the trigger: OUT and SYNC.

- OUT. This is the main output. The maximum output voltage is 50V.
- SYNC. The SYNC pulse is a fixed-width TTL-level reference pulse used to trigger oscilloscopes or other measurement systems.

When the ADVANCE/DELAY switch is set to "ADVANCE", the SYNC output precedes the main output. These pulses are illustrated below:

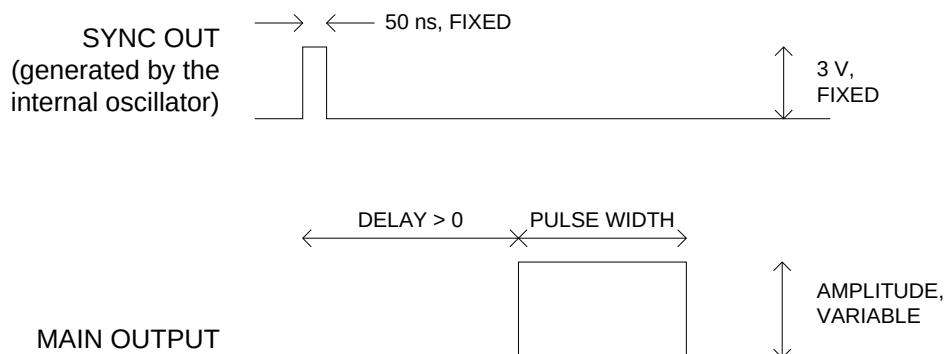

When the ADVANCE/DELAY switch is set to “DELAY”, the TRIG output occurs after the main output. This illustrated below:

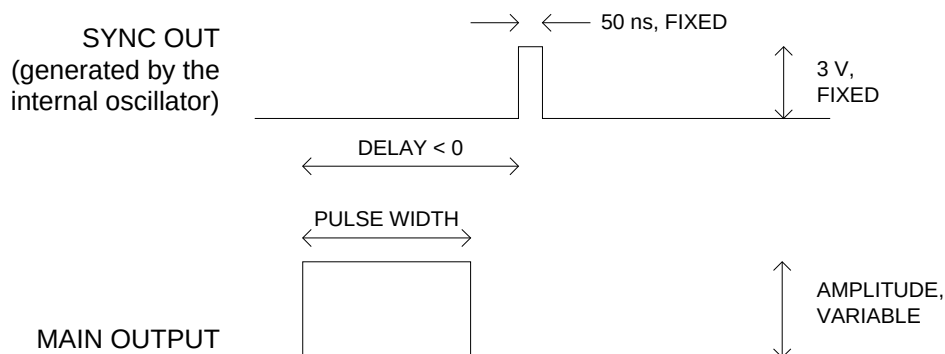

When triggered externally, the EXT TRIG connector acts as an input:

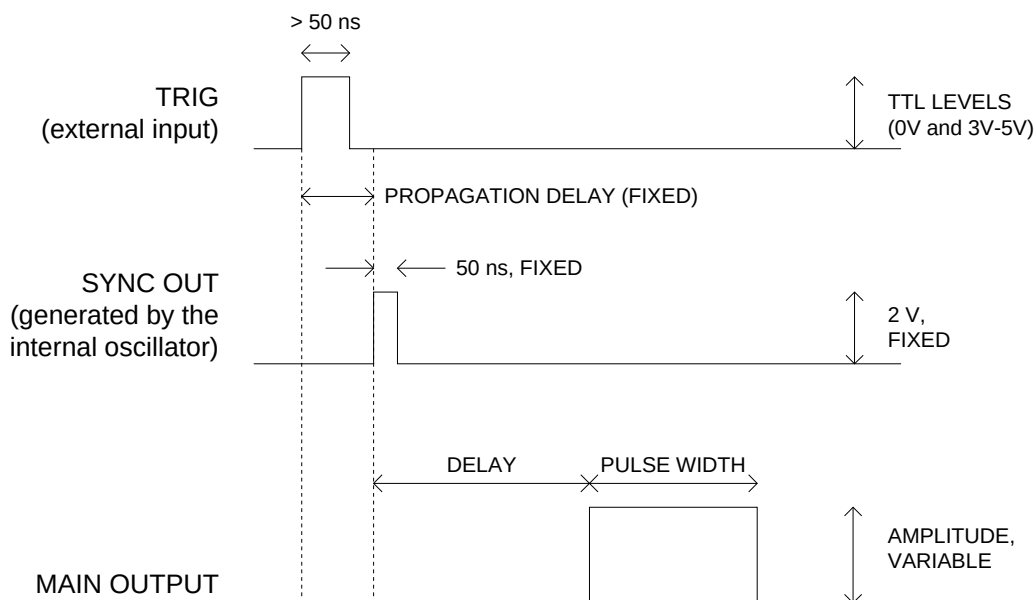

An external trigger may alternatively be applied to the rear-panel “PW” input. If the adjacent switch is set to “EXT”, the instrument will be triggered by this input, and the output pulse width will be approximately equal to the input pulse width. The front-panel timing controls are disabled in this mode.

MINIMIZING WAVEFORM DISTORTIONS

OUTPUT IMPEDANCE

The output impedance of the AV-1015-C can be set at 2Ω or 50Ω using the amplitude range switch. The output impedance is 2Ω in the $\pm 50\text{V}$ ranges, and 50Ω in the lower ranges.

When driving a high impedance load (i.e., $R_L \gg 50\Omega$), the amplitude range should be set so that the output impedance is 50Ω . This will minimize waveform ringing and transmission line reflections, without adversely affecting the pulse amplitude. In this configuration, the output voltage will be twice the voltage that would be observed into a 50Ω load (i.e., the $+25\text{V}$ range will actually provide up to $+50\text{V}$).

When driving a 50Ω load, it is also highly desirable to set the output impedance to 50Ω . However, the output impedance and the load resistance will cause a resistive voltage-divider effect, reducing the output amplitude at the load by a factor of two. Thus, the 50Ω output impedance ranges can only be used to generate amplitudes of up to $\pm 25\text{V}$.

See Application Note 1A, at <http://www.avtechpulse.com/appnote/av1010/>, for more information.

GENERATING LOW-VOLTAGE WAVEFORMS

When generating low-voltage waveforms, the output waveforms will have much less distortion (i.e. ringing) if the output impedance is set to 50Ω .

USE 50Ω TRANSMISSION LINES

Connect the load to the pulse generator with 50Ω transmission lines (e.g. RG-58 or RG-174 cable). If possible, use a 50Ω load. If the actual device under test has a high impedance, consider adding a 50Ω termination in parallel with the load to properly terminate the transmission line.

Setting the pulse generator output impedance to 50Ω will “back-match” the transmission line, resulting in improved performance.

USE LOW-INDUCTANCE LOADS

Lenz’s Law predicts that for an inductive voltage spike will be generated when the current through an inductance changes. Specifically, $V_{\text{SPIKE}} = L \times dI_{\text{LOAD}}/dt$, where L is the inductance, I_{LOAD} is the load current change, and t is time. For this reason, it is

important to keep any parasitic in the load low. This means keeping wiring short, and using low inductance components. In particular, wire-wound resistors should be avoided.

OPERATIONAL CHECK

This check is to confirm that the instrument is fully functional. Set the controls to the following values:

FRONT PANEL

- INT/EXT Switch: INT position
- REPETITION RATE RANGE Switch: 10 kHz
- REPETITION RATE Vernier: Maximum (fully clockwise)
- DELAY RANGE Switch: 1 us
- DELAY Vernier: MID range
- ADVANCE, DELAY, DOUBLE PULSE: DELAY
- PULSE WIDTH RANGE Switch: 1 us
- PULSE WIDTH Vernier: Maximum (fully clockwise)
- AMPLITUDE RANGE Switch: +50V
- AMPLITUDE Vernier: 5.0 (half-maximum)

REAR PANEL

- AMP: INT
- PW: INT

Connect a cable from the SYNC OUT connector to the TRIG input of an oscilloscope. Connect a 2W (or higher) 50 Ohm load to the OUT connector and place the scope probe across this load.

Set the oscilloscope to trigger externally with the vertical setting at 5 Volts/div and the horizontal setting at 1 us/div. Then follow the instructions below and compare what is seen on the oscilloscope to what is described. Only approximate values are needed to confirm operation.

STEP	CONTROL	OPERATION	RESULTS
1	POWER	Push in (ON)	+25V pulses at the main output, with period 100 us, pulse width 1.0 us, <10ns rise & fall times.
2	REPETITION RATE VERNIER	Rotate to Minimum (fully counter-clockwise), then to Maximum (fully clockwise)	Period rises to about 1 ms then falls to about 100 us.
3	DELAY VERNIER	Rotate to Maximum (fully clockwise), then to Minimum (fully counter-clockwise)	Pulses shift to the right on the oscilloscope by 1 us, then back.
4	PULSE WIDTH VERNIER	Rotate to Minimum (fully counter-clockwise), then to Maximum (fully clockwise)	Pulse width varies from 100 ns to 1.0 us.
5	AMPLITUDE RANGE SWITCH	Switch to -50V, then to +50V	Pulse polarity becomes negative & then positive.

TYPICAL WAVEFORMS

Figure 1 shows typical output waveforms with the pulse generator amplitude set to the maximum of the +50V range, and the pulse width set to 500 ns. The pulse generator is connected to a 50Ω load through an 8" length of RG-174 cable.

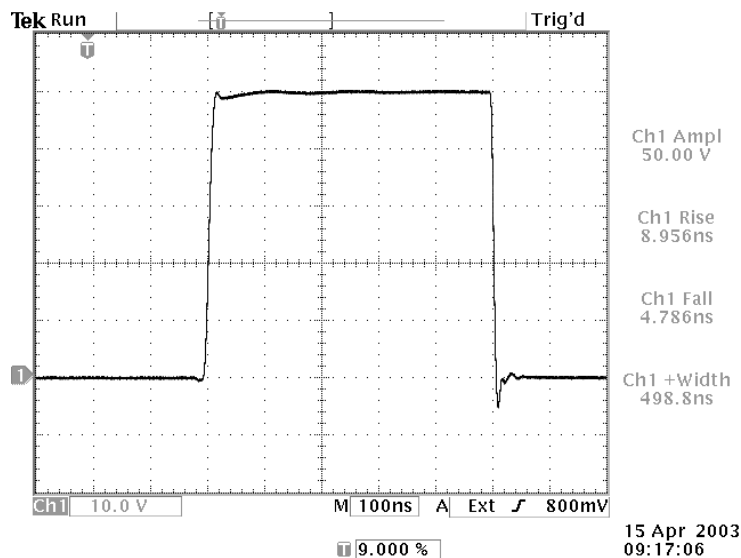

Figure 1 (10V/div, 100 ns/div)

Figure 2 shows the results with similar settings, except that the amplitude range has been switched from +50V to +25V. In this range, the output impedance is 50Ω. This provides transmission line backmatching, and as a result, the waveform shows less distortion on the very fast falling edge.

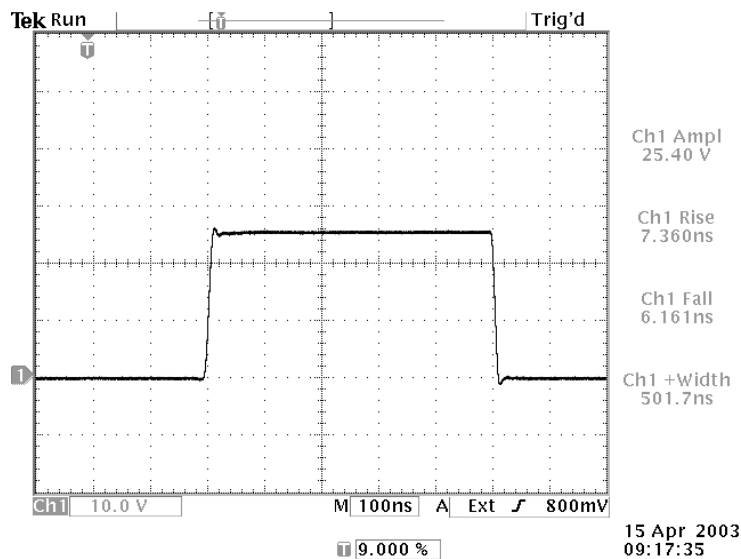

Figure 2 (10V/div, 100 ns/div)

Figure 3 shows the output with the amplitude set to the maximum in the +0.75V range.

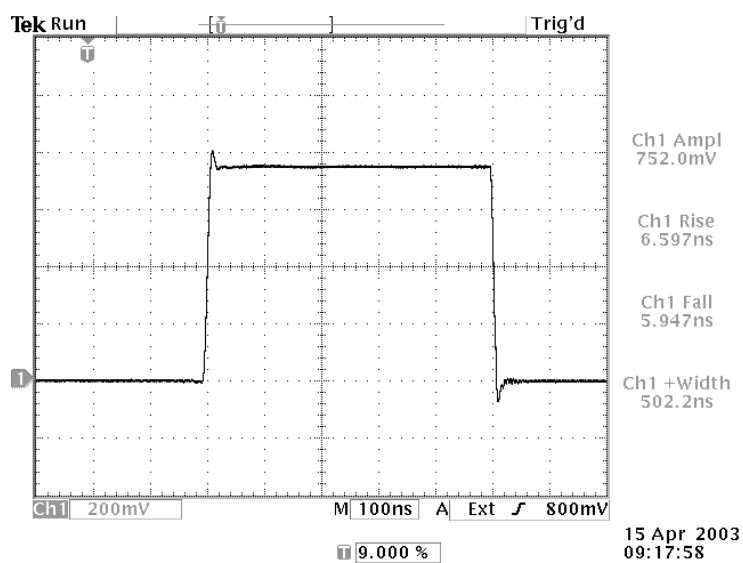

Figure 3 (0.2V/div, 100 ns/div)

MECHANICAL INFORMATION

TOP COVER REMOVAL

If necessary, the interior of the instrument may be accessed by removing the four Phillips screws on the top panel. With the four screws removed, the top cover may be slid back (and off).

Always disconnect the power cord before opening the instrument.

There are no user-adjustable internal circuits. For repairs other than fuse replacement, please contact Avtech (info@avtechpulse.com) to arrange for the instrument to be returned to the factory for repair.



Caution: High voltages are present inside the instrument during normal operation. Do not operate the instrument with the cover removed.

RACK MOUNTING

A rack mounting kit is available. The -R5 rack mount kit may be installed after first removing the one Phillips screw on the side panel adjacent to the front handle.

ELECTROMAGNETIC INTERFERENCE

To prevent electromagnetic interference with other equipment, all used outputs should be connected to shielded 50Ω loads using shielded 50Ω coaxial cables. Unused outputs should be terminated with shielded 50Ω BNC terminators or with shielded BNC dust caps, to prevent unintentional electromagnetic radiation. All cords and cables should be less than 3m in length.

MAINTENANCE

REGULAR MAINTENANCE

This instrument does not require any regular maintenance.

On occasion, one or more of the four rear-panel fuses may require replacement. All fuses can be accessed from the rear panel. See the “FUSES” section for details.

CLEANING

If desired, the interior of the instrument may be cleaned using compressed air to dislodge any accumulated dust. (See the “TOP COVER REMOVAL” section for instructions on accessing the interior.) No other cleaning is recommended.

PERFORMANCE CHECK SHEET