



AVTECH ELECTROSYSTEMS LTD.

NANOSECOND WAVEFORM ELECTRONICS  
SINCE 1975

P.O. BOX 265  
OGDENSBURG, NY  
U.S.A. 13669-0265

TEL: 888-670-8729 (USA & Canada) or +1-613-686-6675 (Intl)  
FAX: 800-561-1970 (USA & Canada) or +1-613-686-6679 (Intl)

info@avtechpulse.com - <http://www.avtechpulse.com/>

BOX 5120, LCD MERIVALE  
OTTAWA, ONTARIO  
CANADA K2C 3H5

## INSTRUCTIONS

MODEL AV-1030-C

±5 VOLTS, 10 MHz

GENERAL PURPOSE PULSE GENERATOR

WITH 300 ps RISE TIMES

SERIAL NUMBER: \_\_\_\_\_

### WARRANTY

Avtech Electrosystems Ltd. warrants products of its manufacture to be free from defects in material and workmanship under conditions of normal use. If, within one year after delivery to the original owner, and after prepaid return by the original owner, this Avtech product is found to be defective, Avtech shall at its option repair or replace said defective item. This warranty does not apply to units which have been disassembled, modified or subjected to conditions exceeding the applicable specifications or ratings. This warranty is the extent of the obligation assumed by Avtech with respect to this product and no other warranty or guarantee is either expressed or implied.

### TECHNICAL SUPPORT

Phone: 888-670-8729 (USA & Canada) or +1-613-686-6675 (International)

Fax: 800-561-1970 (USA & Canada) or +1-613-686-6679 (International)

E-mail: [info@avtechpulse.com](mailto:info@avtechpulse.com)

World Wide Web: <http://www.avtechpulse.com>

## TABLE OF CONTENTS

<b>WARRANTY.....</b>	<b>2</b>
<b>TECHNICAL SUPPORT.....</b>	<b>2</b>
<b>TABLE OF CONTENTS.....</b>	<b>3</b>
<b>INTRODUCTION.....</b>	<b>5</b>
<b>SPECIFICATIONS.....</b>	<b>6</b>
<b>REGULATORY NOTES.....</b>	<b>7</b>
FCC PART 18.....	7
EC DECLARATION OF CONFORMITY.....	7
DIRECTIVE 2002/95/EC (RoHS).....	8
DIRECTIVE 2002/96/EC (WEEE).....	8
AC POWER SUPPLY REGULATORY NOTES.....	9
<b>INSTALLATION.....</b>	<b>10</b>
VISUAL CHECK.....	10
POWER RATINGS.....	10
CONNECTION TO THE POWER SUPPLY.....	10
PROTECTION FROM ELECTRIC SHOCK.....	11
ENVIRONMENTAL CONDITIONS.....	12
<b>FUSES.....</b>	<b>13</b>
AC FUSE REPLACEMENT.....	13
DC FUSE REPLACEMENT.....	14
FUSE RATINGS.....	14
<b>FRONT PANEL CONTROLS.....</b>	<b>15</b>
<b>REAR PANEL CONTROLS.....</b>	<b>19</b>
<b>GENERAL INFORMATION.....</b>	<b>20</b>
BASIC PULSE CONTROL.....	20
TRIGGER MODES.....	22
GATING MODES.....	23
<b>MINIMIZING WAVEFORM DISTORTIONS.....</b>	<b>24</b>
USE 50Ω TRANSMISSION LINES.....	24
USE LOW-INDUCTANCE LOADS.....	24
<b>PROTECTING YOUR INSTRUMENT.....</b>	<b>25</b>
TURN OFF INSTRUMENT WHEN NOT IN USE.....	25
AVOID SHORT CIRCUITS.....	25

DUTY CYCLE LIMIT.....	25
<b>OPERATIONAL CHECK.....</b>	<b>26</b>
<b>MECHANICAL INFORMATION.....</b>	<b>28</b>
TOP COVER REMOVAL.....	28
RACK MOUNTING.....	28
ELECTROMAGNETIC INTERFERENCE.....	28
<b>MAINTENANCE.....</b>	<b>29</b>
REGULAR MAINTENANCE.....	29
CLEANING.....	29
<b>REPAIR INSTRUCTIONS.....</b>	<b>30</b>
BLOWN FUSES.....	30
DAMAGED MAIN OUTPUT.....	30
<b>WIRING DIAGRAMS.....</b>	<b>31</b>
WIRING OF AC POWER.....	31
PCB 158P - LOW VOLTAGE POWER SUPPLY, 1/3.....	32
PCB 158P - LOW VOLTAGE POWER SUPPLY, 2/3.....	33
PCB 158P - LOW VOLTAGE POWER SUPPLY, 3/3.....	34
MAIN WIRING.....	35
<b>PERFORMANCE CHECK SHEET.....</b>	<b>36</b>

Manual Reference: /filesserver1/officefiles/instructword/av-1030/OBS/AV-1030-C,edition8.odt.

Last modified February 29, 2024.

Copyright © 2024 Avtech Electrosystems Ltd, All Rights Reserved.

## INTRODUCTION

The Avtech AV-1030-C is a versatile, general-purpose, low-cost, 10 MHz laboratory pulse generator, useful everywhere from undergraduate university classrooms to the most advanced research and development laboratories. This pulse generator features variable pulse repetition frequency (PRF), delay, pulse width, and amplitude. It also features an exceptionally fast 300 ps rise time and 350 ps fall time.

The generator can be triggered internally or externally, or by the manual "Single Pulse" pushbutton. All trigger sources can be gated by a TTL-type pulse. The internal trigger is continuously variable from 1 Hz to 10 MHz. The delay is variable up to 1 second, and the pulse width is variable to 1 ms. The amplitude is variable up to  $\pm 5V$ .

The main output has all of its characteristics variable, and is designed to drive  $50\Omega$  loads. (A  $50\Omega$  load is required for proper operation.) The main output is AC-coupled. Two logic outputs (TTL and ECL) have approximately the same timing characteristics as the main output, but have their amplitudes fixed at standard logic levels.

A synchronizing trigger output is also supplied, for triggering oscilloscopes and other test equipment (50 ns wide, +2V into  $50\Omega$ ).

Several points should be noted when operating this instrument:

This unit requires a 50 ohm load.

The maximum main output duty cycle is 10%.

The main output is AC-coupled.

This instrument is intended for use in research, development, test and calibration laboratories by qualified personnel.

## SPECIFICATIONS

Model:	AV-1030-C
GPIO and RS-232 control:	no
Amplitude (main output) <sup>1</sup> :	±0.2 to ±5 Volts, adjustable
Logic outputs:	One TTL <sup>5</sup> , and one ECL <sup>6</sup> (both non-inverted)
Required load impedance:	50 Ohms <sup>4</sup> .
Output impedance:	At amplitudes of < ±1.5V: 50 Ω, approximately At amplitudes of > ±1.5V: << 50 Ω.
Rise time (20%-80%):	≤ 300 ps
Fall time (80%-20%):	≤ 350 ps
PRF:	1 Hz to 10 MHz
Pulse width (FWHM) <sup>2</sup> :	10 ns to 1 ms
Jitter:	≤ ± 25 ps ± 0.01 % of Sync delay (SYNC out to main OUT)
Polarity (main output):	Positive or negative, switchable
Duty cycle (max):	10 %
Waveform aberrations:	Overshoot, undershoot, and ringing are less than ±20% at amplitudes of 0.5V and higher <sup>1</sup> with outputs terminating in 50 Ohms.
Droop:	≤ 10% at maximum pulse width
Trigger required:	External trigger mode: TTL levels <sup>5</sup> , ≥ 4 ns width
Gate input:	TTL low: No output. TTL high (or unconnected): Normal output
Propagation delay:	< 100 ns (Ext Trig to Out)
Sync delay:	± 50 ns to ± 1 ms
Sync output:	+3 Volts, 50 ns, will drive 50 Ohm loads
Single pulse mode:	Yes, push-button controlled
Signal connectors:	Main output: SMA. Other: BNC
Power requirement:	100 – 240 V, 50 - 60 Hz
Dimensions (H x W x D):	100 mm x 430 mm x 375 mm (3.9" x 17" x 14.8")
Chassis material:	Anodized aluminum, with blue plastic trim
Temperature range:	+5°C to +40°C
Optional rack-mount kit:	Add the suffix "-R5" to the model number to include the 19" rack mount kit
Optional accessory kit:	Add the suffix "-AK1" to the model number to include the recommended accessory kit. Consists of three SMA, 18 GHz, 2 Watt attenuators (10, 20 & 30 dB) for use on the output, and two 50 Ohm, 1 GHz, 1 Watt feed-through terminators (one SMA, one BNC) for use on external trigger inputs.

1) For operation at lower amplitudes, best results will be obtained by setting the amplitude near maximum and using external attenuators on the output. Suitable attenuators are available in the optional accessory kit.

2) The pulse width may vary by ± 5 ns as the amplitude is varied.

3) Add the suffix -VXI to the model number to specify the Ethernet port.

4) A 50 Ohm load is required. Other loads may damage the instrument. Consult Avtech ([info@avtechpulse.com](mailto:info@avtechpulse.com)) if you need to drive other load impedances.

5) TTL levels: low = 0 to +0.8V, high = +3 to +5V (fixed)

6) ECL levels: low = -1.6V high: -0.8V (fixed)

## REGULATORY NOTES

### FCC PART 18

This device complies with part 18 of the FCC rules for non-consumer industrial, scientific and medical (ISM) equipment.

This instrument is enclosed in a rugged metal chassis and uses a filtered power entry module (where applicable). The main output signal is provided on a shielded connector that is intended to be used with shielded coaxial cabling and a shielded load. Under these conditions, the interference potential of this instrument is low.

If interference is observed, check that appropriate well-shielded cabling is used on the output connectors. Contact Avtech ([info@avtechpulse.com](mailto:info@avtechpulse.com)) for advice if you are unsure of the most appropriate cabling. Also, check that your load is adequately shielded. It may be necessary to enclose the load in a metal enclosure.

If any of the connectors on the instrument are unused, they should be covered with shielded metal "dust caps" to reduce the interference potential.

This instrument does not normally require regular maintenance to minimize interference potential. However, if loose hardware or connectors are noted, they should be tightened. Contact Avtech ([info@avtechpulse.com](mailto:info@avtechpulse.com)) if you require assistance.

### EC DECLARATION OF CONFORMITY



We                    Avtech Electrosystems Ltd.  
                          P.O. Box 5120, LCD Merivale  
                          Ottawa, Ontario  
                          Canada K2C 3H4

declare that this pulse generator meets the intent of Directive 2004/108/EG for Electromagnetic Compatibility. Compliance pertains to the following specifications as listed in the official Journal of the European Communities:

EN 50081-1 Emission

EN 50082-1 Immunity

and that this pulse generator meets the intent of the Low Voltage Directive 72/23/EEC as amended by 93/68/EEC. Compliance pertains to the following specifications as listed in the official Journal of the European Communities:

EN 61010-1:2001 Safety requirements for electrical equipment for measurement, control, and laboratory use

#### DIRECTIVE 2002/95/EC (RoHS)

This instrument is exempt from Directive 2002/95/EC of the European Parliament and of the Council of 27 January 2003 on the Restriction of the use of certain Hazardous Substances (RoHS) in electrical and electronic equipment. Specifically, Avtech instruments are considered "Monitoring and control instruments" (Category 9) as defined in Annex 1A of Directive 2002/96/EC. The Directive 2002/95/EC only applies to Directive 2002/96/EC categories 1-7 and 10, as stated in the "Article 2 - Scope" section of Directive 2002/95/EC.

#### DIRECTIVE 2002/96/EC (WEEE)

European customers who have purchased this equipment directly from Avtech will have completed a "WEEE Responsibility Agreement" form, accepting responsibility for WEEE compliance (as mandated in Directive 2002/96/EC of the European Union and local laws) on behalf of the customer, as provided for under Article 9 of Directive 2002/96/EC.

Customers who have purchased Avtech equipment through local representatives should consult with the representative to determine who has responsibility for WEEE compliance. Normally, such responsibilities will lie with the representative, unless other arrangements (under Article 9) have been made.

Requirements for WEEE compliance may include registration of products with local governments, reporting of recycling activities to local governments, and financing of recycling activities.





## AC POWER SUPPLY REGULATORY NOTES

This instrument converts the AC input power to the +24V DC voltage that powers the internal circuitry of this instrument using a Tamura AAD130SD-60-A switching power supply. According to the manufacturer, the Tamura AAD130SD-60-A has the following certifications:

UL60950-1  
IEC60950 -1  
CSA C22.2 No. 60950- 1  
EN60950 -1

and is compliant with:

EN61000-3-2  
EN61000-4-2 Level 2  
EN61000-4-2 Level 3 (Air Only)  
EN61000-4-4 Level 3  
EN61000-4-5 Level 3  
EN61000-4-11  
CISPR 11 and 22 FCC Part 15 Class B (conducted)

## INSTALLATION

### VISUAL CHECK

After unpacking the instrument mainframe and the transformer module, examine to ensure that they have not been damaged in shipment. Visually inspect all connectors, knobs, and handles. Confirm that a power cord and an instrumentation manual (this manual), are with the instrument. If the instrument has been damaged, file a claim immediately with the company that transported the instrument.

### POWER RATINGS

This instrument is intended to operate from 100 - 240 V, 50 - 60 Hz.

The maximum power consumption is 57 Watts. Please see the “FUSES” section for information about the appropriate AC and DC fuses.

This instrument is an “Installation Category II” instrument, intended for operation from a normal single-phase supply.

### CONNECTION TO THE POWER SUPPLY

An IEC-320 three-pronged recessed male socket is provided on the back panel for AC power connection to the instrument. One end of the detachable power cord that is supplied with the instrument plugs into this socket. The other end of the detachable power cord plugs into the local mains supply. Use only the cable supplied with the instrument. The mains supply must be earthed, and the cord used to connect the instrument to the mains supply must provide an earth connection. (The supplied cord does this.)

 Warning: Failure to use a grounded outlet may result in injury or death due to electric shock. This product uses a power cord with a ground connection. It must be connected to a properly grounded outlet. The instrument chassis is connected to the ground wire in the power cord.

The table below describes the power cord that is normally supplied with this instrument, depending on the destination region:

Destination Region	Description	Option	Manufacturer	Part Number
United Kingdom, Hong Kong, Singapore, Malaysia	BS 1363, 230V, 50 Hz	-AC00	Qualtek	370001-E01
Australia, New Zealand	AS 3112:2000, 230-240V, 50 Hz	-AC01	Qualtek	374003-A01
Continental Europe, Korea, Indonesia, Russia	European CEE 7/7 "Schuko" 230V, 50 Hz	-AC02	Qualtek	364002-D01
North America, Taiwan	NEMA 5-15, 120V, 60 Hz	-AC03	Qualtek	312007-01
Switzerland	SEV 1011, 230V, 50 Hz	-AC06	Qualtek	378001-E01
South Africa, India	SABS 164-1, 220-250V, 50 Hz	-AC17	Volex	2131H 10 C3
Japan	JIS 8303, 100V, 50-60 Hz	-AC18	Qualtek	397002-01
Israel	SI 32, 220V, 50 Hz	-AC19	Qualtek	398001-01
China	GB 1002-1, 220V, 50 Hz	-AC22	Volex	2137H 10 C3

## PROTECTION FROM ELECTRIC SHOCK

 Operators of this instrument must be protected from electric shock at all times. The owner must ensure that operators are prevented access and/or are insulated from every connection point. In some cases, connections must be exposed to potential human contact. Operators must be trained to protect themselves from the risk of electric shock. This instrument is intended for use by qualified personnel who recognize shock hazards and are familiar with safety precautions required to avoid possibly injury. In particular, operators should:

1. Keep exposed high-voltage wiring to an absolute minimum.
2. Wherever possible, use shielded connectors and cabling.
3. Connect and disconnect loads and cables only when the instrument is turned off.
4. Keep in mind that all cables, connectors, oscilloscope probes, and loads must have an appropriate voltage rating.
5. Do not attempt any repairs on the instrument, beyond the fuse replacement procedures described in this manual. Contact Avtech technical support (see page 2 for contact information) if the instrument requires servicing. Service is to be performed solely by qualified service personnel.

## ENVIRONMENTAL CONDITIONS

This instrument is intended for use under the following conditions:

1. indoor use;
2. altitude up to 2 000 m;
3. temperature 5 °C to 40 °C;
4. maximum relative humidity 80 % for temperatures up to 31 °C decreasing linearly to 50 % relative humidity at 40 °C;
5. Mains supply voltage fluctuations up to  $\pm 10$  % of the nominal voltage;
6. no pollution or only dry, non-conductive pollution.

## FUSES

This instrument contains four fuses. All are accessible from the rear-panel. Two protect the AC prime power input, and two protect the internal DC power supplies. The locations of the fuses on the rear panel are shown in the figure below:



### AC FUSE REPLACEMENT

To physically access the AC fuses, the power cord must be detached from the rear panel of the instrument. The fuse drawer may then be extracted using a small flat-head screwdriver, as shown below:



## DC FUSE REPLACEMENT

The DC fuses may be replaced by inserting the tip of a flat-head screwdriver into the fuse holder slot, and rotating the slot counter-clockwise. The fuse and its carrier will then pop out.

## FUSE RATINGS

The following table lists the required fuses:

Fuses	Nominal Mains Voltage	Rating	Case Size	Recommended Replacement Part	
				Littelfuse Part Number	Digi-Key Stock Number
#1, #2 (AC)	100-240V	0.5A, 250V, Time-Delay	5×20 mm	0218.500HXP	F2416-ND
#3 (DC)	N/A	1.0A, 250V, Time-Delay	5×20 mm	0218001.HXP	F2419-ND
#4 (DC)	N/A	Not used. A spare 1.0A fuse is installed here.			

The recommended fuse manufacturer is Littelfuse (<http://www.littelfuse.com>).

Replacement fuses may be easily obtained from Digi-Key (<http://www.digikey.com>) and other distributors.

## FRONT PANEL CONTROLS

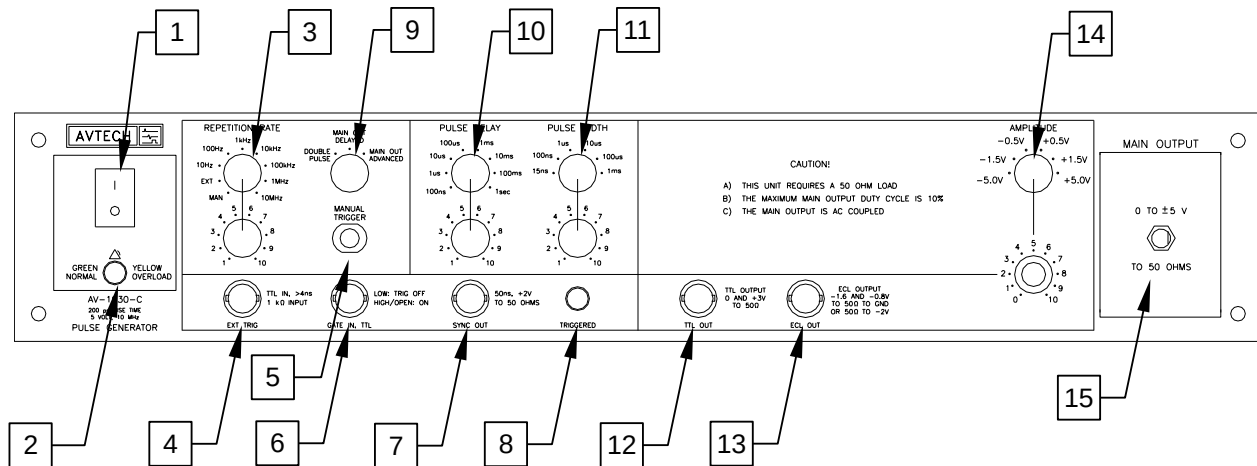

1. POWER Switch. This is the main power switch. When turning the instrument on, there may be a delay of several seconds before the instrument appears to respond.
2. OVERLOAD Indicator. When the instrument is powered, this indicator is normally green, indicating normal operation. If this indicator is yellow, an internal automatic overload protection circuit has been tripped. If the unit is overloaded (by operating at an exceedingly high duty cycle or by operating into a very low impedance), the protective circuit will disable the output of the instrument and turn the indicator light yellow. The light will stay yellow (i.e. output disabled) for about 5 seconds after which the instrument will attempt to re-enable the output (i.e. light green) for about 1 second. If the overload condition persists, the output will be disabled again (i.e. light yellow) for another 5 seconds. If the overload condition has been removed, the instrument will resume normal operation.

This overload indicator may flash yellow briefly at start-up. This is not a cause for concern.

3. REPETITION RATE Controls. This switch sets the triggering mode for the instrument.

In the “MAN” position, the instrument is triggered by the “Manual Trigger” pushbutton (item 5).

In the “EXT” position, the instrument is triggered by externally-generated TTL-level (0 and 3-5V logic levels) pulses on the “EXT TRIG” input connector (item 4).

The remaining positions serve as decade-range controls for the internal oscillator, which triggers the instrument in these positions. The vernier control immediately below the switch provides continuous adjustment of the frequency within each

decade range.

4. EXT TRIG Connector. When the REPETITION RATE switch (item 3) is set to the “EXT” position, a TTL-level pulse applied to this input will trigger the instrument. The instrument triggers on the rising edge of this input. The input impedance of this input is 1 k $\Omega$ . (Depending on the length of cable attached to this input, and the source driving it, it may be desirable to add a coaxial 50 Ohm terminator to this input to provide a proper transmission line termination. The Pasternack ([www.pasternack.com](http://www.pasternack.com)) PE6008-50 BNC feed-thru 50 Ohm terminator is suggested for this purpose.)
5. MANUAL TRIGGER Pushbutton. When the REPETITION RATE switch (item 3) is set to the “MAN” position, the instrument is triggered by pressing this pushbutton. A single trigger event occurs for each press of the pushbutton.
6. GATE IN Connector. This TTL-level (i.e., 0 and 3-5V logic levels) input gates the trigger. If this input is unconnected or TTL-high (3 to 5V), the instrument will trigger normally. If this input is TTL-low (0 Volts), triggering is inhibited.
7. SYNC OUT Connector. This output generates a 50 ns wide TTL-level pulse for each trigger event. This output can be used to trigger an oscilloscope, or other test equipment.

The PULSE DELAY controls (item 10) and DELAY MODE switch (item 9) affect the operation of this output. When the DELAY MODE switch is in the “Main Out Delayed” position, the pulses on the main output (item 15) and the logic outputs (items 12-13) are delayed relative to the SYNC OUT pulse by a time controlled by the PULSE DELAY controls (item 10).

When the DELAY MODE switch is in the “Main Out Advanced” position, the pulses on the main output (item 15) and the logic outputs (items 12-13) are advanced relative to the SYNC OUT pulse by a time controlled by the PULSE DELAY controls (item 10).

When the DELAY MODE switch is in the “Double Pulse” position, the SYNC OUT pulse is approximately coincident with the first pulse of the pair of pulses on the main output.

For this output to operate correctly, the delay setting must be less than the period.

8. TRIGGERED Indicator. This indicator is lit when pulses are detected on the logic outputs (items 12-13), and it gives an indication that the timing parameters have been set properly and do not conflict.

If this indicator is not lit, it suggests that instrument is not triggering, or that the delay or pulse width settings exceed the pulse period.



9. DELAY MODE Switch. This switch determines the function of the PULSE DELAY controls (item 10). When this switch is set in the “DOUBLE PULSE” position, the main output (item 15) and the logic outputs (items 12-13) generate a pair of pulses in response to each trigger event. The DELAY controls determine the spacing between the first and second pulses in the pair. The SYNC OUT pulse is approximately coincident with the first pulse of the pair of pulses on the main output.

When the DELAY MODE switch is in the “Main Out Delayed” position, the pulses on the main output (item 15) and the four logic outputs (items 12-13) are delayed relative to the SYNC OUT pulse by a time controlled by the PULSE DELAY controls (item 10). The SYNC OUT pulse itself is generated after a minimal delay relative to the trigger source. (This is the most common mode of operation.)

When the DELAY MODE switch is in the “Main Out Advanced” position, the pulses on the main output (item 19) and the four logic outputs (items 12-13) are approximately coincident with the trigger event, and the SYNC output is delayed relative to the main output and logic outputs by a time controlled by the PULSE DELAY controls (item 10).

10. PULSE DELAY Controls. This decade range switch, and the vernier control immediately below, control the separation between the main and logic outputs (items 12-13 and 15) and the SYNC OUT output (item 7).
11. PULSE WIDTH Controls. This decade range switch, and the vernier control immediately below, control the pulse width of the main and logic outputs (items 12-13 and 15).
12. TTL OUT Connector. This output provides a TTL-level pulse (quiescent level: 0V, pulse level: 3-5V) whose triggering, delay, and pulse width are controlled by the front-panel controls. The amplitude and rise and fall times are fixed. This output will drive impedances of 50 Ohms or greater. To minimize distortion, this output should ideally be connected using 50 Ohm coaxial cabling, and terminated with a 50 Ohm load.
13. ECL OUT Connector. This output provides an ECL-level pulse (quiescent level: -1.6V, pulse level: -0.8V) whose triggering, delay, and pulse width are controlled by the front-panel controls. The amplitude and rise and fall times are fixed. This output will drive a load of 50 Ohms or greater, connected to ground or to -2V. To minimize distortion, this output should ideally be connected using 50 Ohm coaxial cabling, and terminated with a 50 Ohm load.
14. AMPLITUDE Controls. This range switch and vernier dial control the amplitude of the main output (item 15).

The best performance will be obtained when the lowest amplitude range consistent with the desired amplitude is used.

15. MAIN OUTPUT Connector. This is the main output. The amplitude may be varied between -5V and +5V. A 50 Ohm load is *required* for proper operation. (This output will not operate properly into a high impedance load.) This output is AC-coupled.

## REAR PANEL CONTROLS

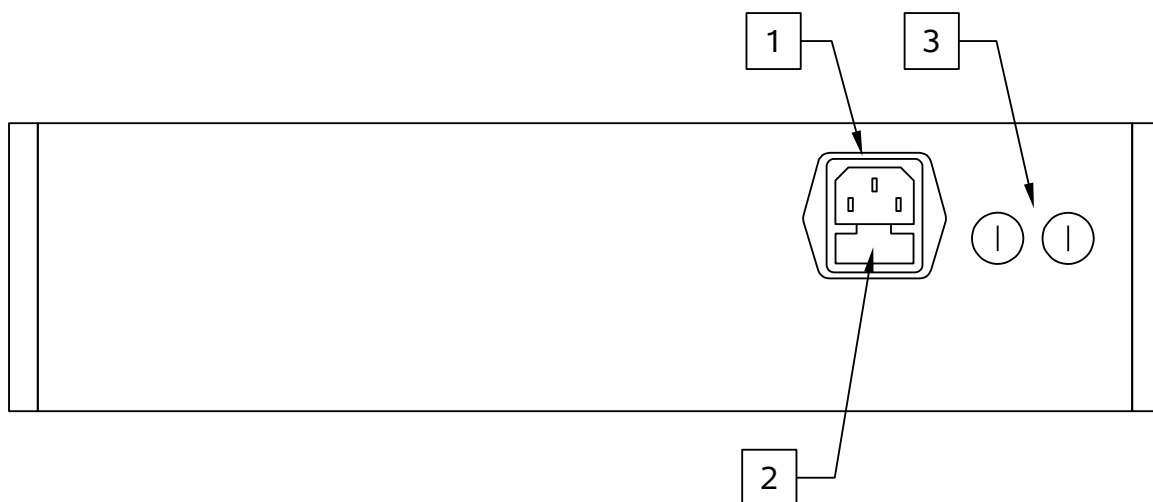

1. AC POWER INPUT. An IEC-320 C14 three-pronged recessed male socket is provided on the back panel for AC power connection to the instrument. One end of the detachable power cord that is supplied with the instrument plugs into this socket.
2. AC FUSE DRAWER. The two fuses that protect the AC input are located in this drawer. Please see the “FUSES” section of this manual for more information.
3. DC FUSES. These two fuses protect the internal DC power supplies. Please see the “FUSES” sections of this manual for more information.

## GENERAL INFORMATION

### BASIC PULSE CONTROL

This instrument can be triggered by its own internal clock, by an external TTL trigger signal, or by the front-panel MANUAL TRIGGER pushbutton. In any case, 4 output channels respond to the trigger: MAIN OUTPUT, SYNC, TTL, and ECL. The MAIN OUTPUT channel is the signal that is normally applied to the load. Its amplitude and pulse width are variable. The SYNC pulse is a fixed-width TTL-level reference pulse used to trigger oscilloscopes or other measurement systems. When the delay is set to a positive value the SYNC pulse precedes the OUT pulse. When the delay is set to a negative value the SYNC pulse follows the OUT pulse.

The two logic outputs (TTL and ECL) are approximately coincident with the main output, but have fixed amplitudes and rise and fall times. These pulses are illustrated below, assuming that internal triggering is used, and the delay mode is set to “MAIN OUT DELAYED”:

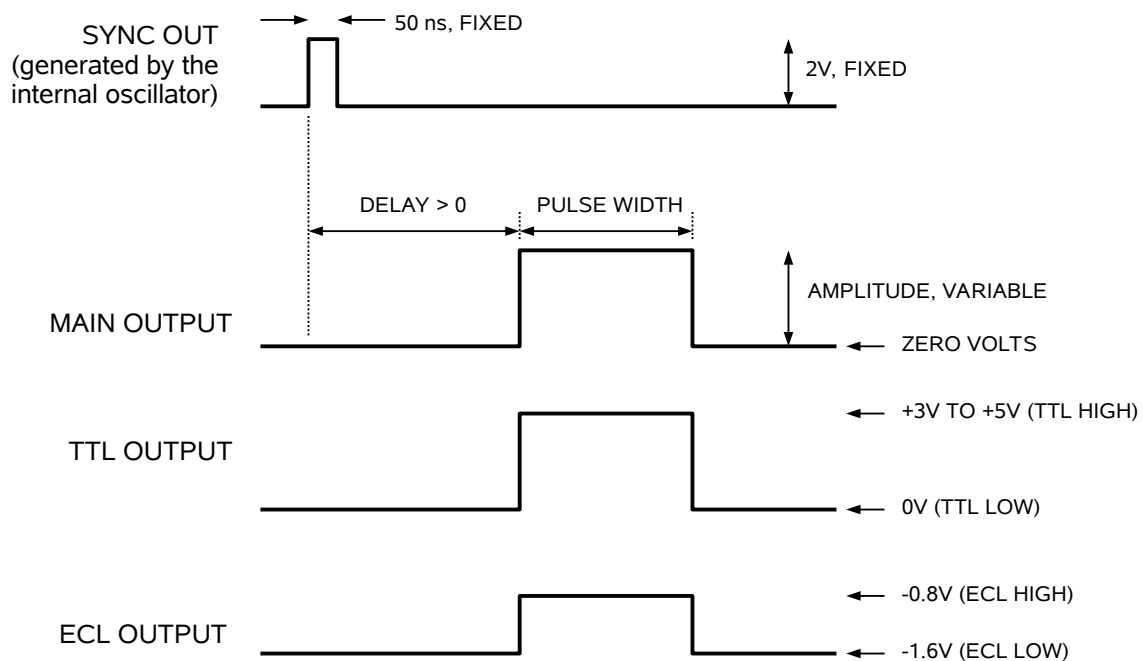

If the delay mode is set to “MAIN OUT ADVANCED”, the order of the SYNC and OUT pulses is reversed:

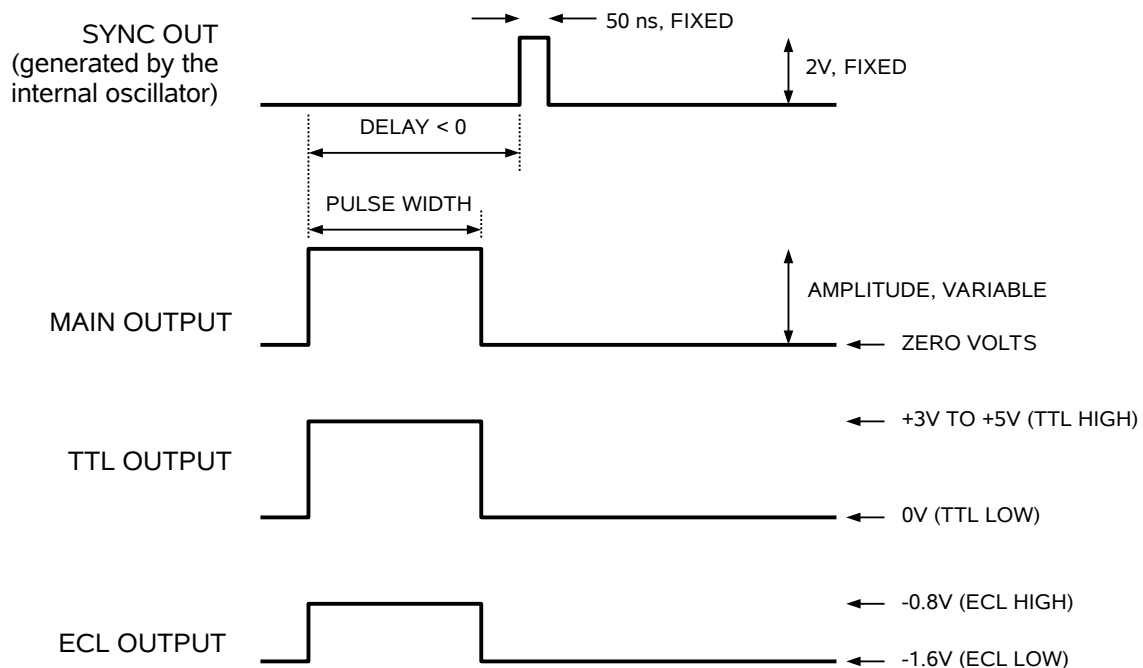

The next figure illustrates the relationship between the signals when an external TTL-level trigger is used (i.e., the REPETITION RATE switch is set to "EXT"), assuming that the delay mode is set to "MAIN OUT DELAYED":

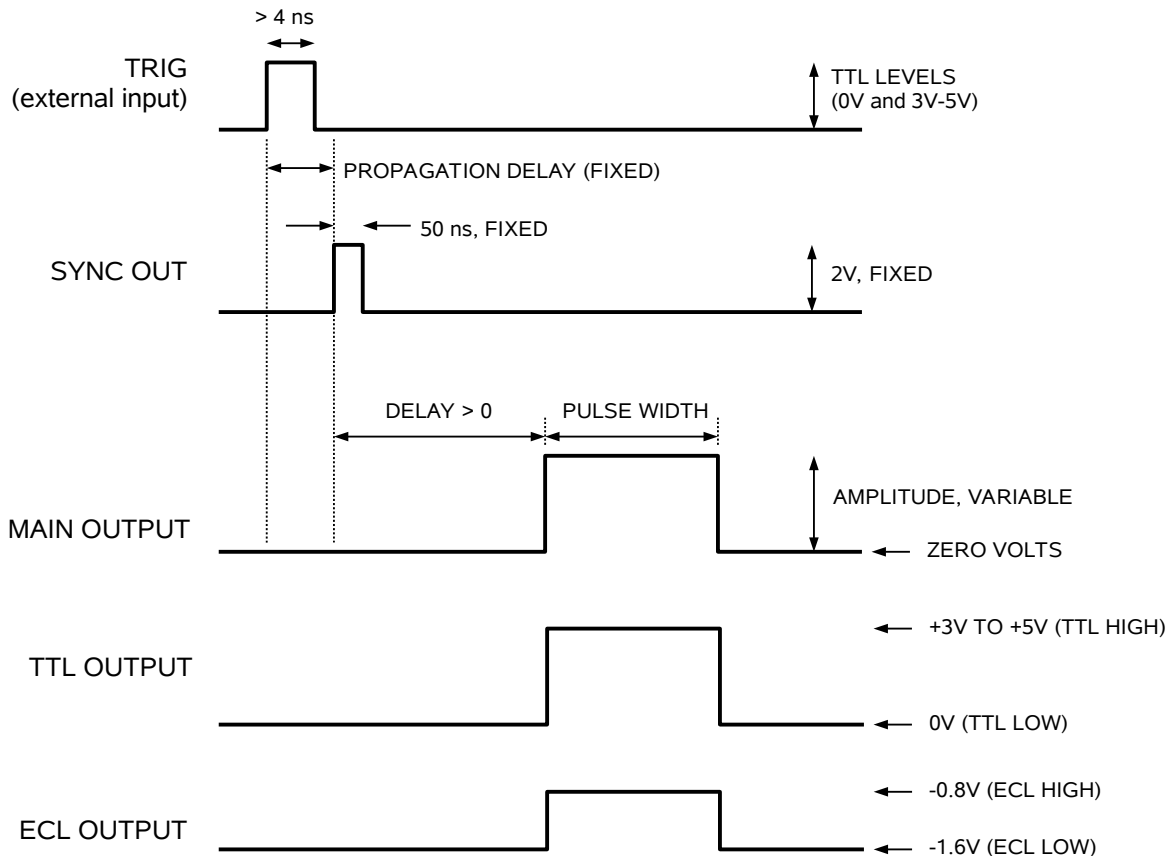

As before, if the delay mode is set to “MAIN OUT ADVANCED”, the order of the SYNC and OUT pulses is reversed.

## TRIGGER MODES

This instrument has three trigger modes:

- **Internal Trigger:** the instrument controls the trigger frequency, and generates the clock internally. This mode is enabled by setting the REPETITION RATE switch to one of the positions labeled with a frequency (i.e., 1kHz, 10 kHz, etc). The labeled frequency represents the upper end of that frequency range.
- **External Trigger:** the instrument is triggered by an external TTL-level clock on the EXT TRIG connector. This mode is enabled by setting the REPETITION RATE switch to the “EXT” position.
- **Manual Trigger:** the instrument is triggered by the front-panel “MANUAL TRIGGER” pushbutton. This mode is enabled by setting the REPETITION RATE switch to the “MAN” position.

## GATING MODES

Triggering can be suppressed by a TTL-level signal on the GATE IN connector. If the GATE IN input is unconnected or TTL-high (3 to 5V), the instrument will trigger normally. If this input is TTL-low (0 Volts), triggering is inhibited.

## MINIMIZING WAVEFORM DISTORTIONS

### USE 50Ω TRANSMISSION LINES

Connect the load to the pulse generator with 50Ω transmission lines (e.g. RG-58 or RG-174 cable). If possible, use a 50Ω load. If the actual device under test has a high impedance, consider adding a 50Ω termination in parallel with the load to properly terminate the transmission line.

### USE LOW-INDUCTANCE LOADS

Lenz's Law predicts that for an inductive voltage spike will be generated when the current through an inductance changes. Specifically,  $V_{\text{SPIKE}} = L \times di_{\text{LOAD}}/dt$ , where  $L$  is the inductance,  $i_{\text{LOAD}}$  is the load current change, and  $t$  is time. For this reason, it is important to keep any parasitic in the load low. This means keeping wiring short, and using low inductance components. In particular, wire-wound resistors should be avoided.



## PROTECTING YOUR INSTRUMENT

### TURN OFF INSTRUMENT WHEN NOT IN USE

The lifetime of the switching elements in the pulse generator module is proportional to the running time of the instrument. For this reason the prime power to the instrument should be turned off when the instrument is not in use. In the case of failure, the switching elements are easily replaced following the procedure described in a following section.

### AVOID SHORT CIRCUITS

The output stage may be damaged if the output is shorted-circuited to ground or to a DC potential. Failures due to such short circuits are not covered by warranty!

### DUTY CYCLE LIMIT

The maximum duty cycle ( $100\% \times \text{Pulse Width} / \text{Period}$ ) is 10%. Also set the pulse width and frequency controls so that the duty cycle does not exceed this limit, or the output stage components may be over-stressed and damaged.

## OPERATIONAL CHECK

This check is to confirm that the instrument is fully functional. Set the controls to the following values:

REPETITION RATE RANGE Switch: 100 kHz

REPETITION RATE Vernier: fully clockwise (maximum)

PULSE DELAY Switch: 100ns

PULSE DELAY Vernier: fully counter-clockwise (minimum)

PULSE WIDTH Switch: 100ns

PULSE WIDTH Vernier: fully clockwise (maximum)

AMPLITUDE Switch: +5V

AMPLITUDE Vernier: fully clockwise (maximum)

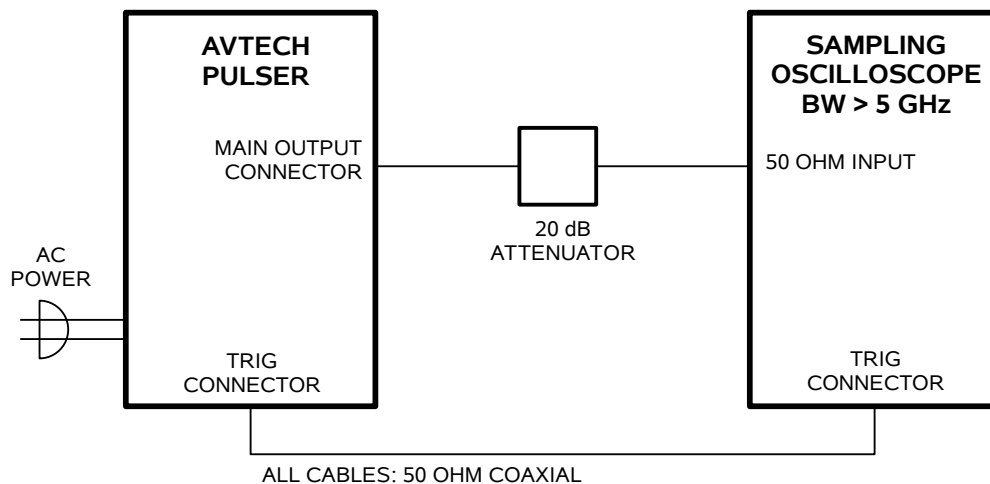

Connect the pulse generator to a sampling oscilloscope as shown above. Note that:

- The use of 20 dB attenuator at the sampling scope vertical input channel will ensure a peak input signal to the sampling scope of less than 1 Volt.
- The TRIG output channel provides TTL level signals (approximately 0 and +3V). To avoid overdriving the TRIG input channel of some scopes, a 20 dB attenuator

may be required at the input to the scope trigger channel.

- The bandwidth capability of components and instruments used to display the pulse generator output signal (attenuators, cables, connectors, etc.) should exceed 5 GHz.
- Set the oscilloscope to trigger externally with the vertical setting at 200 mV/div and the horizontal setting at 20 ns/div.

Follow the instructions in the following table, and compare what is seen on the oscilloscope to what is described. Only approximate values are needed to confirm operation.

STEP	CONTROL	OPERATION	RESULTS
1	Power	Push in (ON)	+5V pulses at the main output, with period 10 us, pulse width 100ns, < 300 ps rise time.
2	Repetition Rate Vernier	Rotate to MIN (1), then to MAX (10)	Period rises to about 100 us, then falls to about 10 us.
3	Delay Vernier	Rotate to MAX, then to MIN	Pulses shift to the right on the oscilloscope by 100 ns, then back.
4	Pulse Width Vernier	Rotate to MIN, then to MAX	Pulses become very narrow (about 10 ns wide), then return to 100 ns pulse width.
5	Amplitude Switch	Switch to -5V, then to +5V	Pulses swing between 0 and -5V, then swing between 0 and +5V.

This completes the operational check.

## MECHANICAL INFORMATION

### TOP COVER REMOVAL

If necessary, the interior of the instrument may be accessed by removing the four Phillips screws on the top panel. With the four screws removed, the top cover may be slid back (and off).

 Always disconnect the power cord and allow the instrument to sit unpowered for 10 minutes before opening the instrument. This will allow any internal stored charge to discharge.

There are no user-adjustable internal circuits. For repairs other than fuse replacement, please contact Avtech ([info@avtechpulse.com](mailto:info@avtechpulse.com)) to arrange for the instrument to be returned to the factory for repair. Service is to be performed solely by qualified service personnel.

 Caution: High voltages are present inside the instrument during normal operation. Do not operate the instrument with the cover removed.

### RACK MOUNTING

A rack mounting kit is available. The -R5 rack mount kit may be installed after first removing the one Phillips screw on the side panel adjacent to the front handle.

### ELECTROMAGNETIC INTERFERENCE

To prevent electromagnetic interference with other equipment, all used outputs should be connected to shielded loads using shielded coaxial cables. Unused outputs should be terminated with shielded coaxial terminators or with shielded coaxial dust caps, to prevent unintentional electromagnetic radiation. All cords and cables should be less than 3m in length.

## MAINTENANCE

### REGULAR MAINTENANCE

This instrument does not require any regular maintenance.

On occasion, one or more of the four rear-panel fuses may require replacement. All fuses can be accessed from the rear panel. See the “FUSES” section for details.

### CLEANING

If desired, the interior of the instrument may be cleaned using compressed air to dislodge any accumulated dust. (See the “TOP COVER REMOVAL” section for instructions on accessing the interior.) No other cleaning is recommended.

## REPAIR INSTRUCTIONS

 Caution: High voltages are present inside the instrument during normal operation. Do not operate the instrument with the cover removed.

### BLOWN FUSES

See the “AC FUSE REPLACEMENT” and “DC FUSE REPLACEMENT” for fuse replacement instructions.

### DAMAGED MAIN OUTPUT

The integrated circuit (IC) that generates the MAIN OUTPUT signal is installed in a socket, and may be replaced if it has been damaged through improper use. (The output stage does feature protection circuitry).

To replace this IC, turn off the instrument and remove the top cover. Locate the large 24-pin IC immediately behind the MAIN OUTPUT connector. This IC has a black clip-on heatsink. The IC can be removed by gently pulling it up and out of its socket.

The following parts are suitable replacements:

<b><i>Manufacturer</i></b>	<b><i>Website</i></b>	<b><i>P/N</i></b>	<b><i>Production Status</i></b>
Cadeca	<a href="http://www.cadeca.com">http://www.cadeca.com</a>	KH103AI	In production.
Fairchild Semiconductor	<a href="http://www.fairchildsemi.com">http://www.fairchildsemi.com</a>	KH103AI	Discontinued.
Comlinear	(bought by Fairchild)	CLC103AI	Discontinued.
Comlinear	(bought by Fairchild)	CLC103AM	Discontinued.

# WIRING DIAGRAMS

## WIRING OF AC POWER

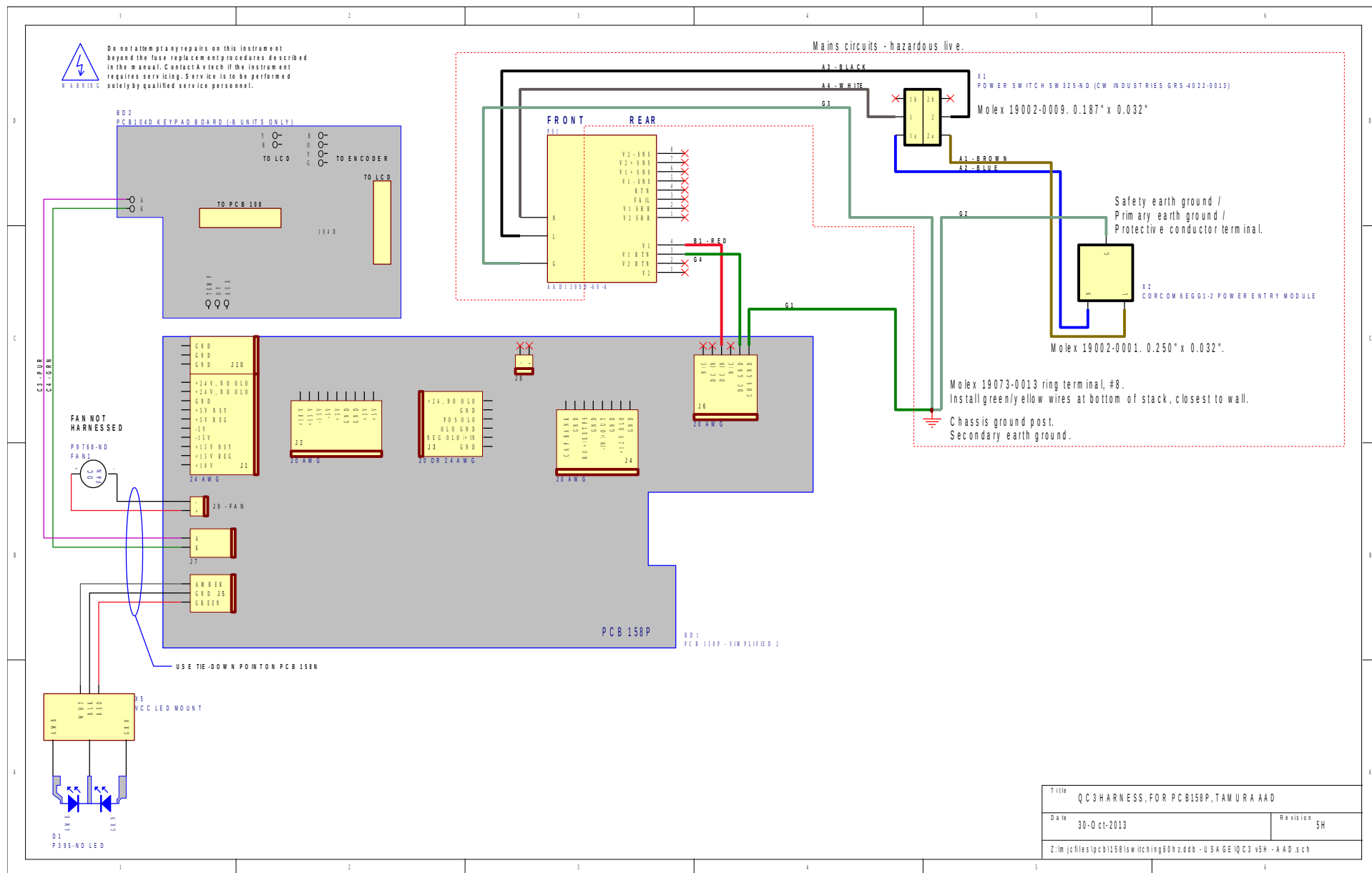

Title		QC3 HARNESS, FOR PCB158P, TAMURA AAD
Date	30-Oct-2013	Revision 5H
Z:\m\jch\files\pcb158p\wiring\60hz.ddb - USA GE IQC3 v5H - AAD.sch		

# PCB 158P - LOW VOLTAGE POWER SUPPLY, 1/3

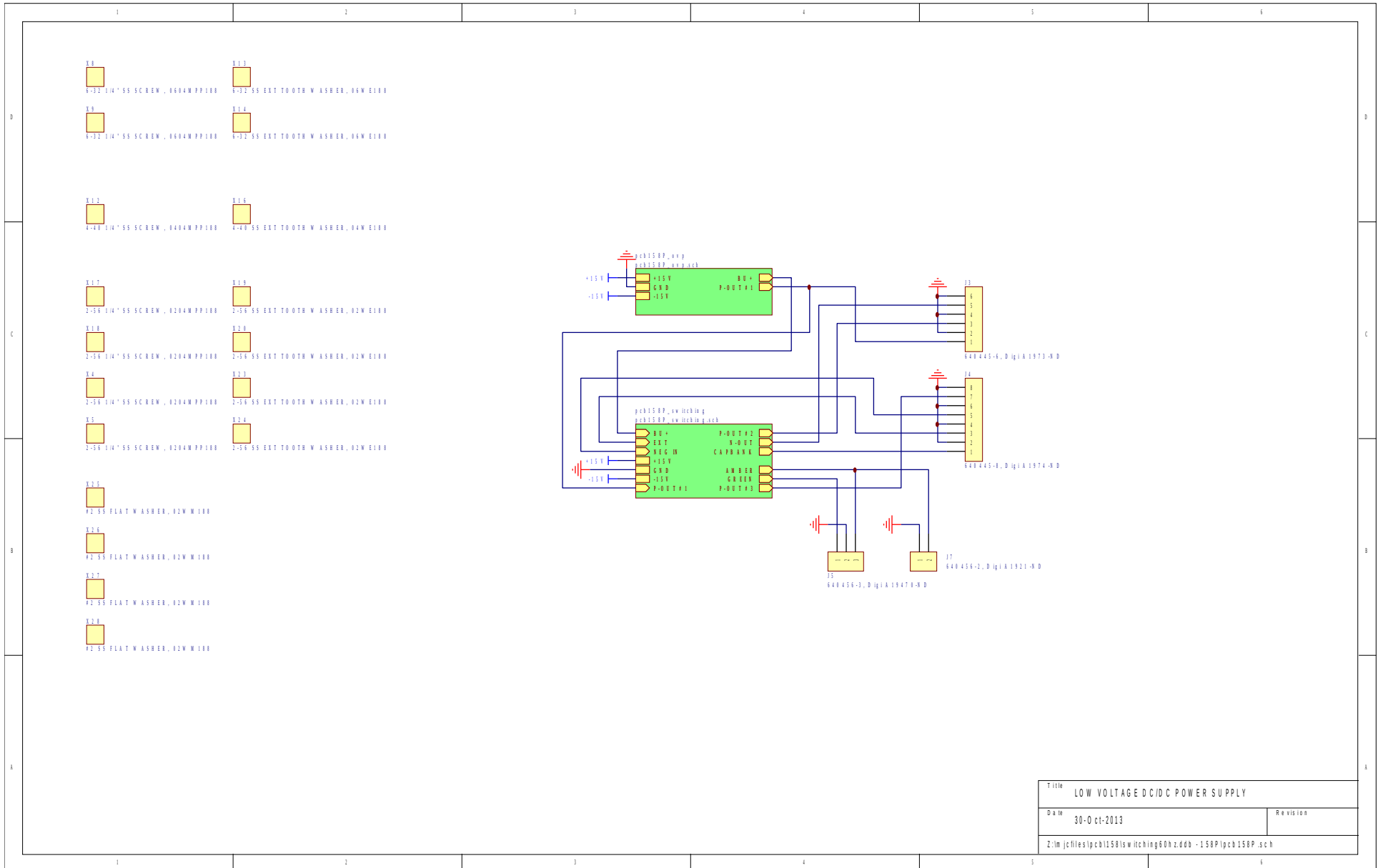

Title		LOW VOLTAGE DC/DC POWER SUPPLY
Date	30-Oct-2013	Revision
Z:\m\jcf\files\pcb158\sw\hchng60hz.ddb - 158P\pcb 158P.sch		



# PCB 158P - LOW VOLTAGE POWER SUPPLY, 2/3

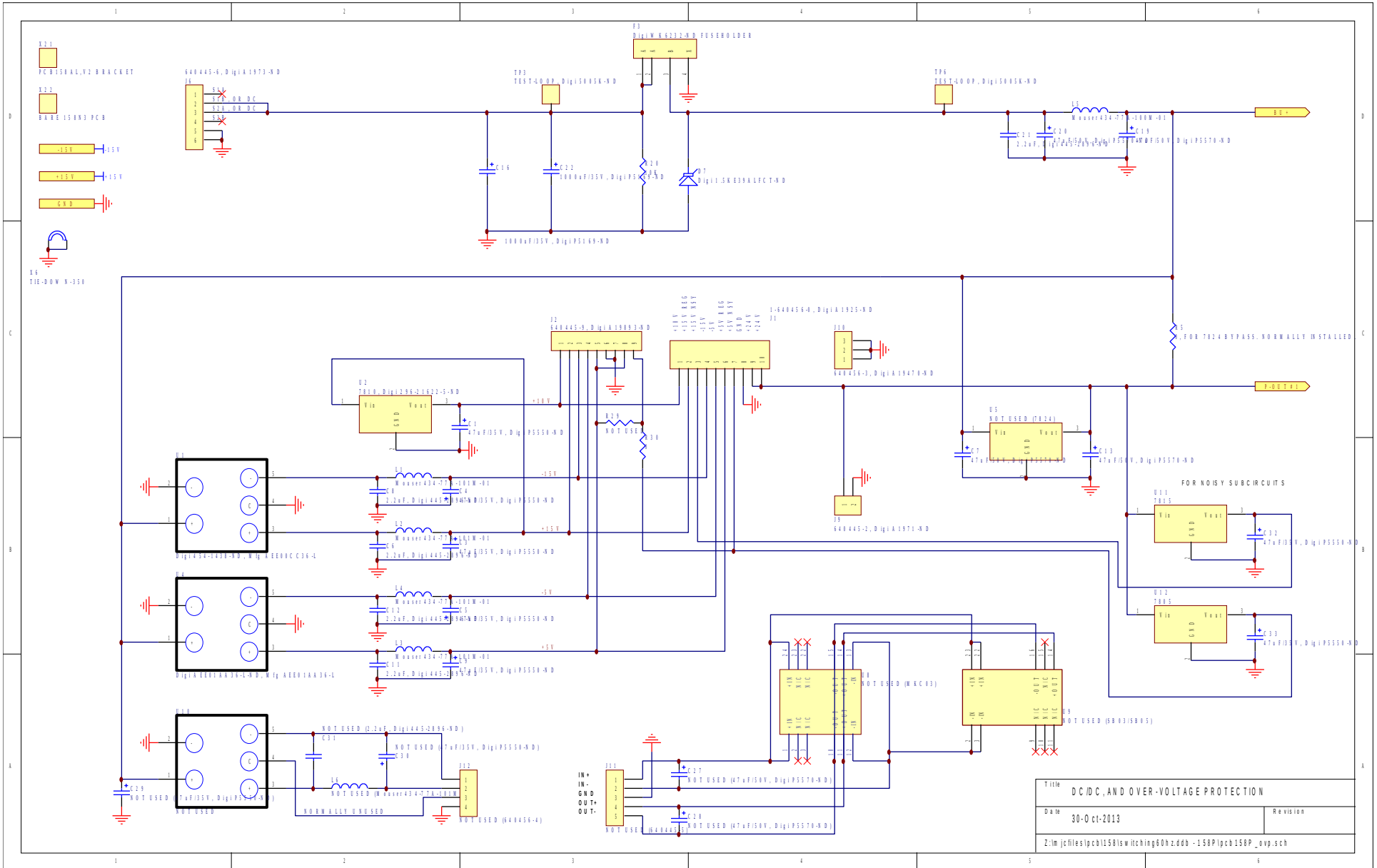

# PCB 158P - LOW VOLTAGE POWER SUPPLY, 3/3

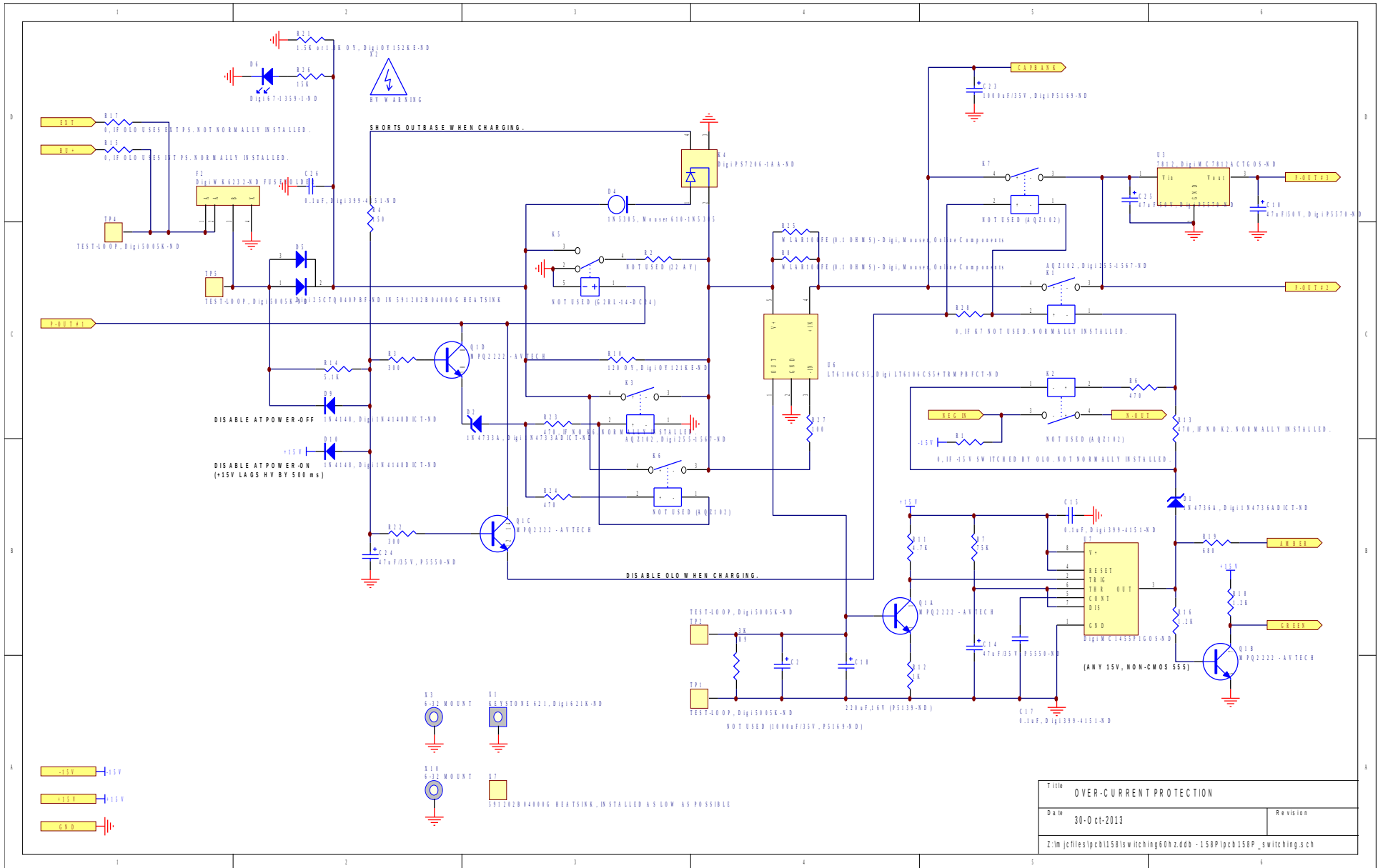

# MAIN WIRING

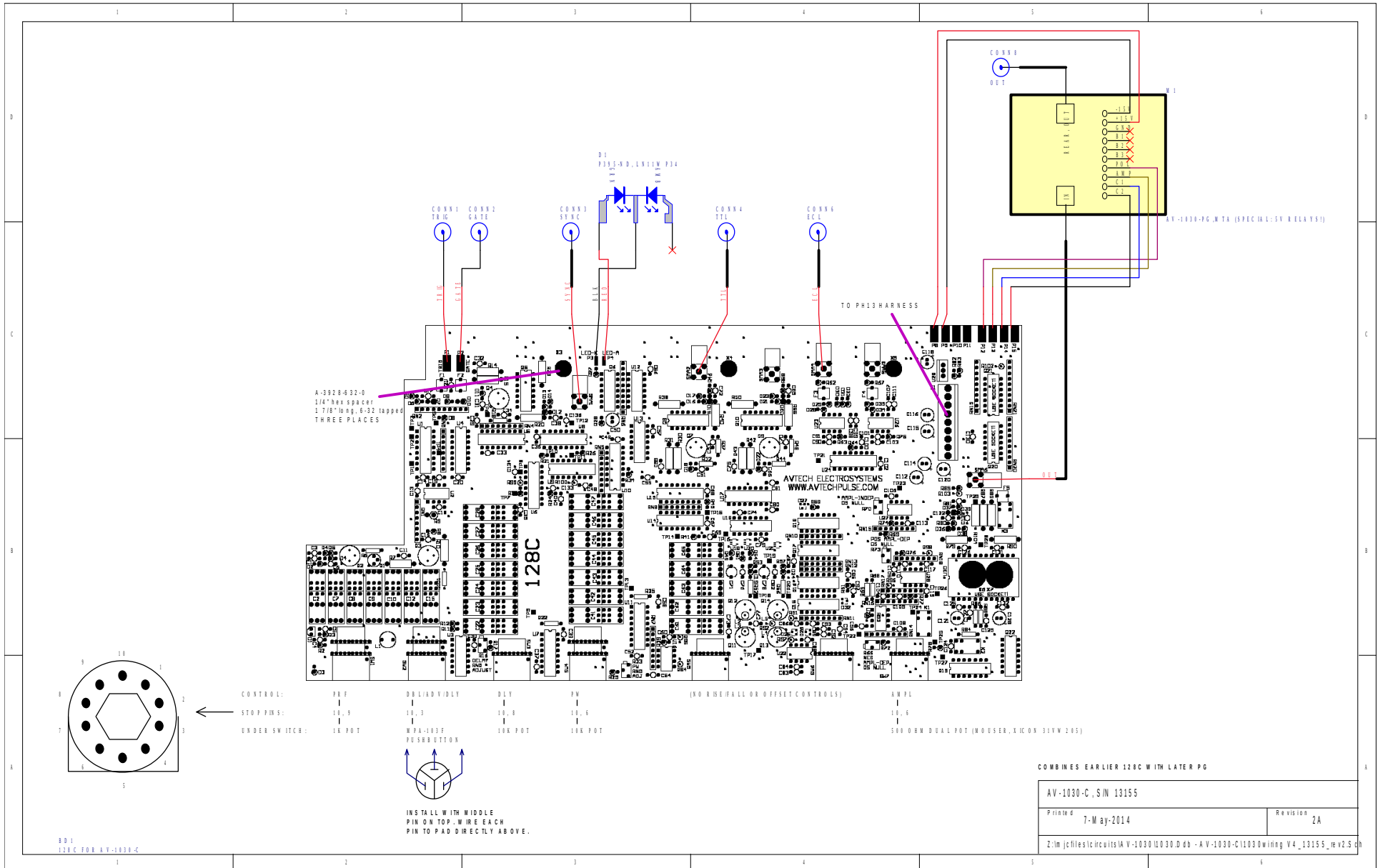

PERFORMANCE CHECK SHEET