

INSTRUCTIONS

MODEL AV-110B-PS AMPLIFIER

S.N.:

WARRANTY

Avtech Electrosystems Ltd. warrants products of its manufacture to be free from defects in material and workmanship under conditions of normal use. If, within one year after delivery to the original owner, and after prepaid return by the original owner, this Avtech product is found to be defective, Avtech shall at its option repair or replace said defective item. This warranty does not apply to units which have been disassembled, modified or subjected to conditions exceeding the applicable specifications or ratings. This warranty is the extent of the obligation assumed by Avtech with respect to this product and no other warranty or guarantee is either expressed or implied.

TECHNICAL SUPPORT

Phone: 613-226-5772 or 1-800-265-6681

Fax: 613-226-2802 or 1-800-561-1970

E-mail: info@avtechpulse.com

World Wide Web: <http://www.avtechpulse.com>

TABLE OF CONTENTS

WARRANTY.....	2
TECHNICAL SUPPORT.....	2
FIG.1: BASIC TEST SET-UP.....	4
GENERAL OPERATING INSTRUCTIONS.....	5
FIG. 2: FRONT PANEL CONTROLS.....	7
FRONT PANEL CONTROLS.....	8
FIG. 3: BACK PANEL CONTROLS.....	9
BACK PANEL CONTROLS.....	10
POWER SUPPLY AND FUSE REPLACEMENT.....	11
PERFORMANCE CHECK SHEET.....	13

FIG.1: BASIC TEST SET-UP

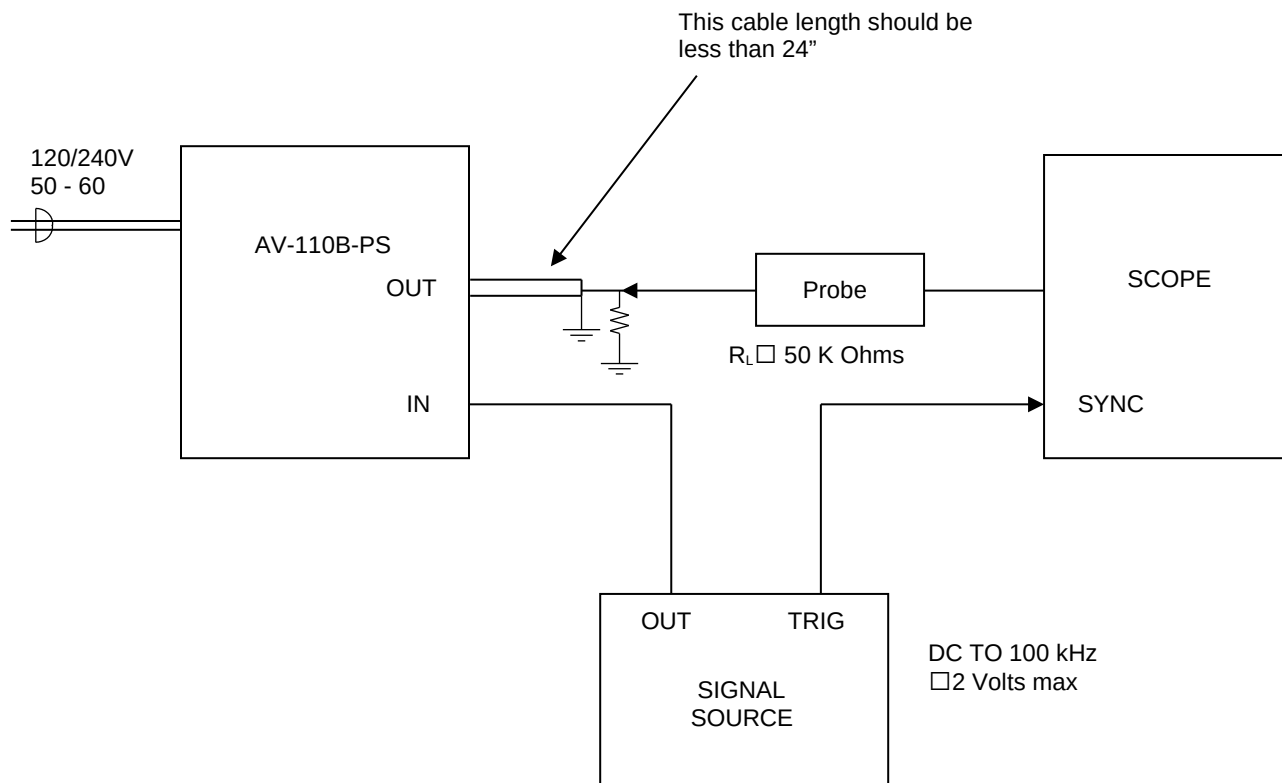

GENERAL OPERATING INSTRUCTIONS

CAUTION: This unit provides output Voltages as high as 400 Volts (peak to peak) so extreme caution must be employed when using this instrument. The unit should only be used by individuals who are thoroughly skilled in high voltage laboratory techniques.

- 1) Connect the instrument as shown above. Do not apply prime power.
- 2) Terminate OUT in a load impedance of 50K (or higher). Note that the length of 50 Ohm cable between the output connector and the load should be less than 24" in order to avoid distortion of the waveform.
- 3) Set the amplitude control to maximum counter clockwise.
- 4) Set the input signal amplitude at 4 Volts (peak to peak) and the frequency at 50 kHz.
- 5) Set the scope time base on about 10 us/div and the vertical on about 50 Volts/div and set the scope time base to trigger on EXT (+).
- 6) Turn on the prime power and adjust scope trigger controls to obtain a trace.
- 7) Rotate the amplitude control clockwise to obtain the desired output amplitude (as high as 400 Volts peak to peak).
- 8) **CAUTION:** Take great care not to operate into a low impedance (i.e. < 50K) or into a short circuit as this may result in damage to the output stage.
- 9) Units with a serial number higher than 5600 are protected by an automatic overload protective circuit which controls the front panel overload light. If the unit is overloaded (by operating at an exceedingly high duty cycle or by operating into a short circuit), the protective circuit will turn the output of the instrument OFF and turn the indicator light ON. The light will stay ON (i.e. output OFF) for about 5 seconds after which the instrument will attempt to turn ON (i.e. light OFF) for about 1 second. If the overload condition persists, the instrument will turn OFF again (i.e. light ON) for another 5 seconds. If the overload condition has been removed, the instrument will turn on and resume normal operation. Overload conditions may be removed by:
 - 1) Removing output load short circuit (if any)
 - 2) Reducing the output amplitude

Note the overload light may activate when the prime power is turned on. The light will extinguish after a few seconds.

10) The unit can be converted from 120 to 240V 50-60 Hz operation by adjusting the voltage selector card in the rear panel fused voltage selector-cable connector assembly.

11) For additional assistance:

Tel: (613) 226-5772

Fax: (613) 226-2802

Email: info@avtechpulse.com

FIG. 2: FRONT PANEL CONTROLS

FRONT PANEL CONTROLS

- (1) ON-OFF Switch. Applies prime power to all stages.
- (2) IN. The input signal is applied to this BNC connector (max 4 Volts peak to peak, DC to 100kHz).
- (3) OUT. BNC connector provides output to high impedance load ($\geq 50K$).
- (4) AMPLITUDE. Ten turn control determines amplitude of output.
- (5) OVERLOAD. Units with a serial number higher than 5600 are protected by an automatic overload protective circuit which controls the front panel overload light. If the unit is overloaded (by operating at an exceedingly high duty cycle or by operating into a short circuit), the protective circuit will turn the output of the instrument OFF and turn the indicator light ON. The light will stay ON (i.e. output OFF) for about 5 seconds after which the instrument will attempt to turn ON (i.e. light OFF) for about 1 second. If the overload condition persists, the instrument will turn OFF again (i.e. light ON) for another 5 seconds. If the overload condition has been removed, the instrument will turn on and resume normal operation. Overload conditions may be removed by:
 - 1) Removing output load short circuit (if any)
 - 2) Reducing the output amplitude

Note that the overload light may come on when the prime power is applied. The light will extinguish after a few seconds.

FIG. 3: BACK PANEL CONTROLS

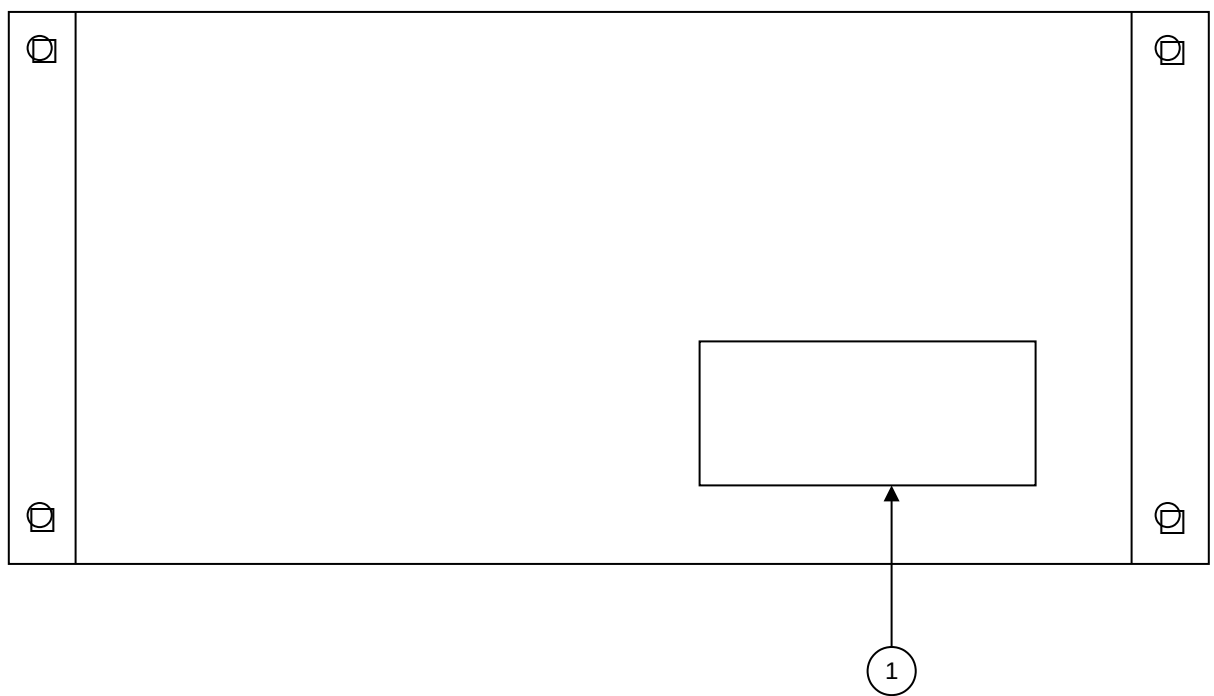

BACK PANEL CONTROLS

- (1) FUSED CONNECTOR, VOLTAGE SELECTOR. The detachable power cord is connected at this point. In addition, the removable cord is adjusted to select the desired input operating voltage. The unit also contains the main power fuse.

For AC line voltages of 110-120V, the power selector card should be installed so that the "120" marking is visible from the rear of the instrument.

For AC line voltages of 220-240V, the power selector card should be installed so that the "240" marking is visible from the rear of the instrument.

If it is not set for the proper voltage, remove the fuse and then grasp the card with a pair of pliers and remove it. Rotate horizontally through 180 degrees. Reinstall the card and the correct fuse.

In the 120V setting, a 0.5A slow blow fuse is required. In the 240V setting, a 0.25A slow blow fuse is required.

POWER SUPPLY AND FUSE REPLACEMENT

This instrument has three main fuses, plus two spares. One, which protects the AC input, is located in the rear-panel power entry module, as described in the “Rear Panel Controls” section of this manual. If the power appears to have failed, check the AC fuse first.

The other two fuses (plus two spares) are located on the internal DC power supply, as shown below:

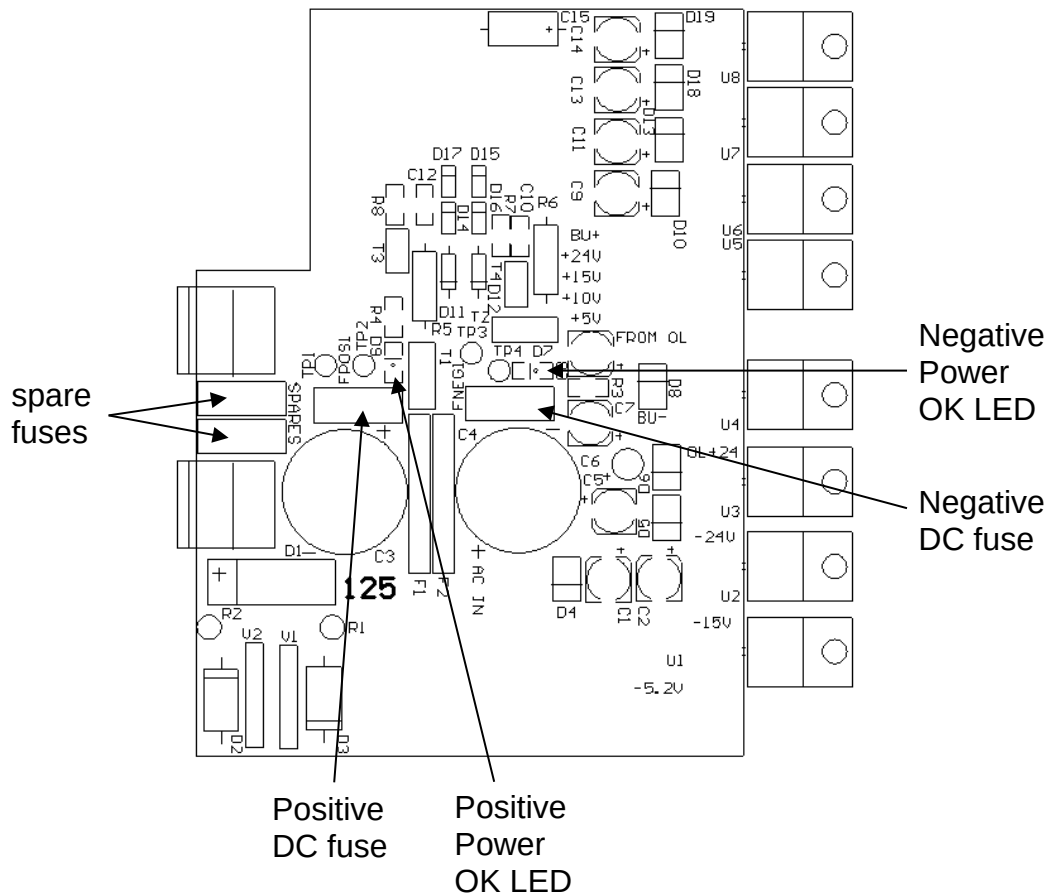

The positive fuse and one of the spare fuses on this circuit board are 1A slow-blow fuses, Littlefuse part number R452001. (This fuse can be ordered from Digikey, www.digikey.com. The Digikey part number is F1343CT-ND). The negative fuse and the second spare fuse are 0.5A slow-blow fuses (Littlefuse R452.500, Digikey part number F1341CT-ND).

If you suspect that the DC fuses are blown, follow this procedure:

1. Remove the top cover, by removing the four Phillips screws on the top cover and then sliding the cover back and off.
2. Locate the two "Power OK" LEDs on the power supply circuit board, as illustrated above.
3. Turn on the instrument.
4. Observe the "Power OK" LEDs. If the fuses are not blown, the two LEDs will be lit (bright red). If one of the LEDs is not lit, the fuse next to it has blown.
5. Turn off the instrument.
6. If a fuse is blown, use needle-nose pliers to remove the blown fuse from its surface-mount holder.
7. Replace the fuse. (Spare 1 Amp and 0.5 Amp fuses are provided on the circuit board. They may be transferred to the active fuse locations using needle-nose pliers.)

PERFORMANCE CHECK SHEET