



AVTECH ELECTROSYSTEMS LTD.

NANOSECOND WAVEFORM ELECTRONICS
SINCE 1975

P.O. BOX 265
OGDENSBURG, NY
U.S.A. 13669-0265

TEL: 888-670-8729 (USA & Canada) or +1-613-686-6675 (Intl)
FAX: 800-561-1970 (USA & Canada) or +1-613-686-6679 (Intl)

info@avtechpulse.com - <http://www.avtechpulse.com/>

BOX 5120, LCD MERIVALE
OTTAWA, ONTARIO
CANADA K2C 3H5

INSTRUCTIONS

MODEL AV-144C3-PS

TTL IN, +30V OUT, into 50 Ω ,

10 ns RISE TIME

DC-COUPLED NON-LINEAR AMPLIFIER

SERIAL NUMBER: _____

WARRANTY

Avtech Electrosystems Ltd. warrants products of its manufacture to be free from defects in material and workmanship under conditions of normal use. If, within one year after delivery to the original owner, and after prepaid return by the original owner, this Avtech product is found to be defective, Avtech shall at its option repair or replace said defective item. This warranty does not apply to units which have been disassembled, modified or subjected to conditions exceeding the applicable specifications or ratings. This warranty is the extent of the obligation assumed by Avtech with respect to this product and no other warranty or guarantee is either expressed or implied.

TECHNICAL SUPPORT

Phone: 888-670-8729 (USA & Canada) or +1-613-686-6675 (International)
Fax: 800-561-1970 (USA & Canada) or +1-613-686-6679 (International)

E-mail: info@avtechpulse.com
World Wide Web: <http://www.avtechpulse.com>

TABLE OF CONTENTS

WARRANTY	2
TECHNICAL SUPPORT	2
TABLE OF CONTENTS	3
INTRODUCTION	5
SPECIFICATIONS.....	5
REGULATORY NOTES	6
FCC PART 18.....	6
EC DECLARATION OF CONFORMITY.....	6
DIRECTIVE 2002/95/EC (RoHS).....	7
DIRECTIVE 2002/96/EC (WEEE).....	7
AC POWER SUPPLY REGULATORY NOTES.....	8
INSTALLATION	9
VISUAL CHECK.....	9
POWER RATINGS.....	9
CONNECTION TO THE POWER SUPPLY.....	9
PROTECTION FROM ELECTRIC SHOCK.....	10
ENVIRONMENTAL CONDITIONS.....	11
FUSES	12
AC FUSE REPLACEMENT.....	12
DC FUSE REPLACEMENT.....	13
FUSE RATINGS.....	13
FRONT PANEL CONTROLS	14
REAR PANEL CONTROLS	16
GENERAL INFORMATION	17
BASIC CONTROL.....	17
LIMITATIONS.....	17
INPUT IMPEDANCE.....	17
MECHANICAL INFORMATION	19
TOP COVER REMOVAL.....	19
RACK MOUNTING.....	19
ELECTROMAGNETIC INTERFERENCE.....	19
MAINTENANCE	20
REGULAR MAINTENANCE.....	20
CLEANING.....	20

WIRING DIAGRAMS.....21

- WIRING OF AC POWER.....21**
- PCB 158P - LOW VOLTAGE POWER SUPPLY, 1/3.....22**
- PCB 158P - LOW VOLTAGE POWER SUPPLY, 2/3.....23**
- PCB 158P - LOW VOLTAGE POWER SUPPLY, 3/3.....24**
- PCB 218A - SUPPLEMENTARY DC/DC CONVERTER.....25**
- PCB 287A - TTL INPUT PROTECTION.....26**
- MAIN WIRING.....27**
- PERFORMANCE CHECK SHEET.....28**

Manual Reference: /files/server1/officefiles/instructword/av-144/AV-144C3-PS,ed1.odt.
Last modified February 29, 2024.
Copyright © 2024 Avtech Electrosystems Ltd, All Rights Reserved.

INTRODUCTION

The Model AV-144C3-PS DC-coupled non-linear amplifier accepts TTL-level input pulses (i.e., low = 0V, high = +3 to +5V), and generates +30V output pulses. The output pulse width is nominally equal to the input pulse width. The output amplitude is not adjustable. The maximum pulse repetition frequency is 1 MHz.

The input impedance is $\geq 1 \text{ k}\Omega$ (or is equal to 50Ω for units with the -Z50 option).

The output will drive loads of $\geq 50 \Omega$.

The output rise and fall times are 10 ns or less.

SPECIFICATIONS

Model:	AV-144C3-PS
Input amplitude:	TTL logic levels (LOW = 0 V, HIGH = +3 to +5 Volts)
Output: ($R_L \geq 50 \Omega$):	+30V, fixed
Rise, fall time (20%-80%):	$\leq 10\text{ns}$
Maximum duty cycle:	No limit
Maximum pulse width:	No limit
Maximum PRF:	1 MHz
Propagation delay:	$< 100 \text{ ns}$
Input impedance:	Standard: $\geq 1 \text{ k}\Omega$. With -Z50 option: 50Ω .
Output impedance:	$< 2 \Omega$
Overshoot:	$< \pm 5\% \pm 0.5\text{V}$
Prime power:	100 - 240V, 50 - 60 Hz
Connectors:	SMA
Dimensions:	100 x 215 x 375 mm (3.9" x 8.5" x 14.8")

REGULATORY NOTES

FCC PART 18

This device complies with part 18 of the FCC rules for non-consumer industrial, scientific and medical (ISM) equipment.

This instrument is enclosed in a rugged metal chassis and uses a filtered power entry module (where applicable). The main output signal is provided on a shielded connector that is intended to be used with shielded coaxial cabling and a shielded load. Under these conditions, the interference potential of this instrument is low.

If interference is observed, check that appropriate well-shielded cabling is used on the output connectors. Contact Avtech (info@avtechpulse.com) for advice if you are unsure of the most appropriate cabling. Also, check that your load is adequately shielded. It may be necessary to enclose the load in a metal enclosure.

If any of the connectors on the instrument are unused, they should be covered with shielded metal “dust caps” to reduce the interference potential.

This instrument does not normally require regular maintenance to minimize interference potential. However, if loose hardware or connectors are noted, they should be tightened. Contact Avtech (info@avtechpulse.com) if you require assistance.

EC DECLARATION OF CONFORMITY



We Avtech Electrosystems Ltd.
 P.O. Box 5120, LCD Merivale
 Ottawa, Ontario
 Canada K2C 3H4

declare that this pulse generator meets the intent of Directive 2004/108/EG for Electromagnetic Compatibility. Compliance pertains to the following specifications as listed in the official Journal of the European Communities:

EN 50081-1 Emission

EN 50082-1 Immunity

and that this pulse generator meets the intent of the Low Voltage Directive 72/23/EEC as amended by 93/68/EEC. Compliance pertains to the following specifications as listed in the official Journal of the European Communities:

EN 61010-1:2001 Safety requirements for electrical equipment for measurement, control, and laboratory use

DIRECTIVE 2002/95/EC (RoHS)

This instrument is exempt from Directive 2002/95/EC of the European Parliament and of the Council of 27 January 2003 on the Restriction of the use of certain Hazardous Substances (RoHS) in electrical and electronic equipment. Specifically, Avtech instruments are considered "Monitoring and control instruments" (Category 9) as defined in Annex 1A of Directive 2002/96/EC. The Directive 2002/95/EC only applies to Directive 2002/96/EC categories 1-7 and 10, as stated in the "Article 2 - Scope" section of Directive 2002/95/EC.

DIRECTIVE 2002/96/EC (WEEE)

European customers who have purchased this equipment directly from Avtech will have completed a "WEEE Responsibility Agreement" form, accepting responsibility for WEEE compliance (as mandated in Directive 2002/96/EC of the European Union and local laws) on behalf of the customer, as provided for under Article 9 of Directive 2002/96/EC.

Customers who have purchased Avtech equipment through local representatives should consult with the representative to determine who has responsibility for WEEE compliance. Normally, such responsibilities will lie with the representative, unless other arrangements (under Article 9) have been made.

Requirements for WEEE compliance may include registration of products with local governments, reporting of recycling activities to local governments, and financing of recycling activities.

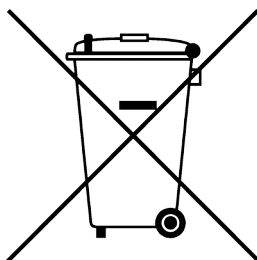

AC POWER SUPPLY REGULATORY NOTES

This instrument converts the AC input power to the DC voltage that powers the internal circuitry of this instrument using a Tamura AAD130SD-60-A switching power supply. According to the manufacturer, the Tamura AAD130SD-60-A has the following certifications:

UL60950-1
IEC60950 -1
CSA C22.2 No. 60950- 1
EN60950 -1

and is compliant with:

EN61000-3-2
EN61000-4-2 Level 2
EN61000-4-2 Level 3 (Air Only)
EN61000-4-4 Level 3
EN61000-4-5 Level 3
EN61000-4-11
CISPR 11 and 22 FCC Part 15 Class B (conducted)

INSTALLATION

VISUAL CHECK

After unpacking the instrument, examine to ensure that they have not been damaged in shipment. Visually inspect all connectors, knobs, and handles. Confirm that a power cord and an instrumentation manual (this manual), are with the instrument. If the instrument has been damaged, file a claim immediately with the company that transported the instrument.

POWER RATINGS

This instrument is intended to operate from 100 - 240 V, 50 - 60 Hz.

The maximum power consumption is 57 Watts. Please see the “FUSES” section for information about the appropriate AC and DC fuses.

This instrument is an “Installation Category II” instrument, intended for operation from a normal single-phase supply.

CONNECTION TO THE POWER SUPPLY

An IEC-320 three-pronged recessed male socket is provided on the back panel for AC power connection to the instrument. One end of the detachable power cord that is supplied with the instrument plugs into this socket. The other end of the detachable power cord plugs into the local mains supply. Use only the cable supplied with the instrument. The mains supply must be earthed, and the cord used to connect the instrument to the mains supply must provide an earth connection. (The supplied cord does this.)

 Warning: Failure to use a grounded outlet may result in injury or death due to electric shock. This product uses a power cord with a ground connection. It must be connected to a properly grounded outlet. The instrument chassis is connected to the ground wire in the power cord.

The table below describes the power cord that is normally supplied with this instrument, depending on the destination region:

Destination Region	Description	Option	Manufacturer	Part Number
United Kingdom, Hong Kong, Singapore, Malaysia	BS 1363, 230V, 50 Hz	-AC00	Qualtek	370001-E01
Australia, New Zealand	AS 3112:2000, 230-240V, 50 Hz	-AC01	Qualtek	374003-A01
Continental Europe, Korea, Indonesia, Russia	European CEE 7/7 "Schuko" 230V, 50 Hz	-AC02	Qualtek	364002-D01
North America, Taiwan	NEMA 5-15, 120V, 60 Hz	-AC03	Qualtek	312007-01
Switzerland	SEV 1011, 230V, 50 Hz	-AC06	Qualtek	378001-E01
South Africa, India	SABS 164-1, 220-250V, 50 Hz	-AC17	Volex	2131H 10 C3
Japan	JIS 8303, 100V, 50-60 Hz	-AC18	Qualtek	397002-01
Israel	SI 32, 220V, 50 Hz	-AC19	Qualtek	398001-01
China	GB 1002-1, 220V, 50 Hz	-AC22	Volex	2137H 10 C3

PROTECTION FROM ELECTRIC SHOCK

 Operators of this instrument must be protected from electric shock at all times. The owner must ensure that operators are prevented access and/or are insulated from every connection point. In some cases, connections must be exposed to potential human contact. Operators must be trained to protect themselves from the risk of electric shock. This instrument is intended for use by qualified personnel who recognize shock hazards and are familiar with safety precautions required to avoid possibly injury. In particular, operators should:

1. Keep exposed high-voltage wiring to an absolute minimum.
2. Wherever possible, use shielded connectors and cabling.
3. Connect and disconnect loads and cables only when the instrument is turned off.
4. Keep in mind that all cables, connectors, oscilloscope probes, and loads must have an appropriate voltage rating.
5. Do not attempt any repairs on the instrument, beyond the fuse replacement procedures described in this manual. Contact Avtech technical support (see page 2 for contact information) if the instrument requires servicing. Service is to be performed solely by qualified service personnel.

ENVIRONMENTAL CONDITIONS

This instrument is intended for use under the following conditions:

1. indoor use;
2. altitude up to 2 000 m;
3. temperature 5 °C to 40 °C;
4. maximum relative humidity 80 % for temperatures up to 31 °C decreasing linearly to 50 % relative humidity at 40 °C;
5. Mains supply voltage fluctuations up to ± 10 % of the nominal voltage;
6. no pollution or only dry, non-conductive pollution.

FUSES

This instrument contains four fuses. All are accessible from the rear-panel. Two protect the AC prime power input, and two protect the internal DC power supplies. The locations of the fuses on the rear panel are shown in the figure below:

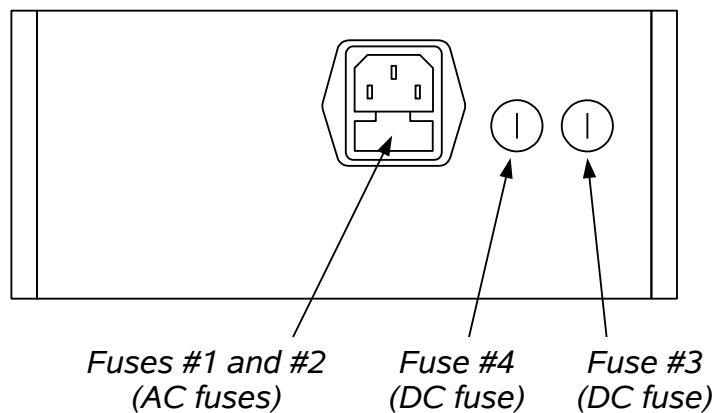

AC FUSE REPLACEMENT

To physically access the AC fuses, the power cord must be detached from the rear panel of the instrument. The fuse drawer may then be extracted using a small flat-head screwdriver, as shown below:

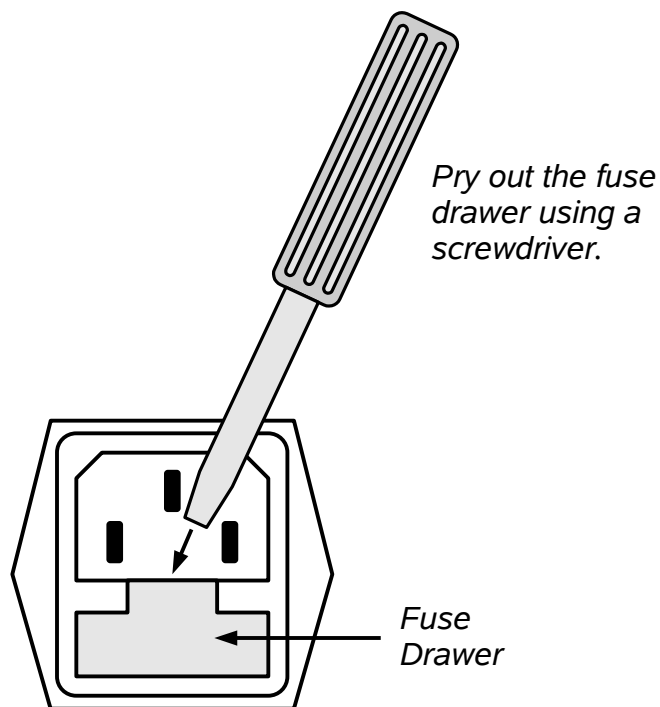

DC FUSE REPLACEMENT

The DC fuses may be replaced by inserting the tip of a flat-head screwdriver into the fuse holder slot, and rotating the slot counter-clockwise. The fuse and its carrier will then pop out.

FUSE RATINGS

The following table lists the required fuses:

Fuses	Nominal Mains Voltage	Rating	Case Size	Recommended Replacement Part	
				Littelfuse Part Number	Digi-Key Stock Number
#1, #2 (AC)	100-240V	0.5A, 250V, Time-Delay	5×20 mm	0218.500HXP	F2416-ND
#3 (DC)	N/A	1.6A, 250V, Time-Delay	5×20 mm	021801.6HXP	F2424-ND
#4 (DC)	N/A	0.8A, 250V, Time-Delay	5×20 mm	0218.800HXP	F2418-ND

The recommended fuse manufacturer is Littelfuse (<http://www.littelfuse.com>).

Replacement fuses may be easily obtained from Digi-Key (<http://www.digikey.com>) and other distributors.

FRONT PANEL CONTROLS

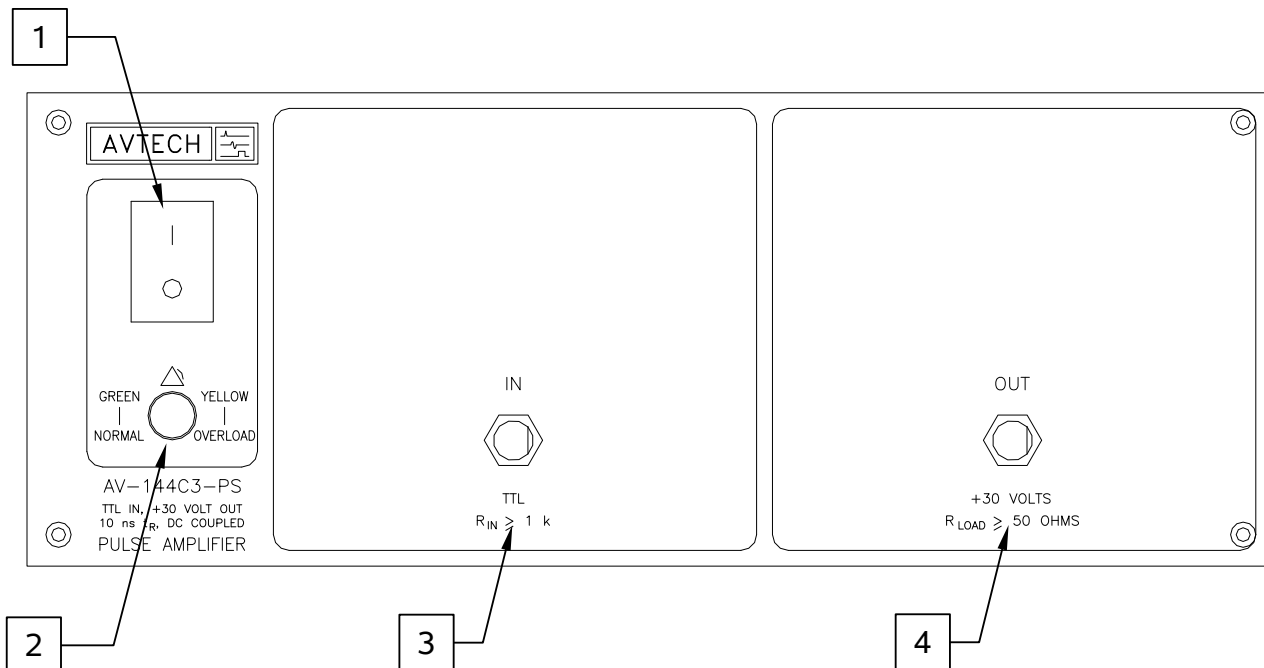

1. **POWER Switch**. This is the main power switch. When turning the instrument on, there may be a delay of several seconds before the instrument appears to respond.
2. **OVERLOAD Indicator**. When the instrument is powered, this indicator is normally green, indicating normal operation. If this indicator is yellow, an internal automatic overload protection circuit has been tripped. If the unit is overloaded (by operating at an exceedingly high duty cycle or by operating into a very low impedance), the protective circuit will disable the output of the instrument and turn the indicator light yellow. The light will stay yellow (i.e. output disabled) for about 5 seconds after which the instrument will attempt to re-enable the output (i.e. light green) for about 1 second. If the overload condition persists, the output will be disabled again (i.e. light yellow) for another 5 seconds. If the overload condition has been removed, the instrument will resume normal operation.

This overload indicator is only likely to come on in two situations:

- Briefly at startup. This is not a cause for concern.
 - When the load impedance is too low ($< 50 \Omega$). In this case, turn off the instrument and connect the proper load.
3. **IN Connector**. The TTL-level input (i.e., low = 0V, high = +3 to +5V) is applied to this SMA connector. The input impedance is $\geq 1 \text{ k}\Omega$ (or is equal to 50Ω for units with the -Z50 option). The maximum pulse repetition frequency is 1 MHz.

4. OUT Connector. This SMA connector provides the main output signal. The output is an amplified version of the input on (3).

REAR PANEL CONTROLS

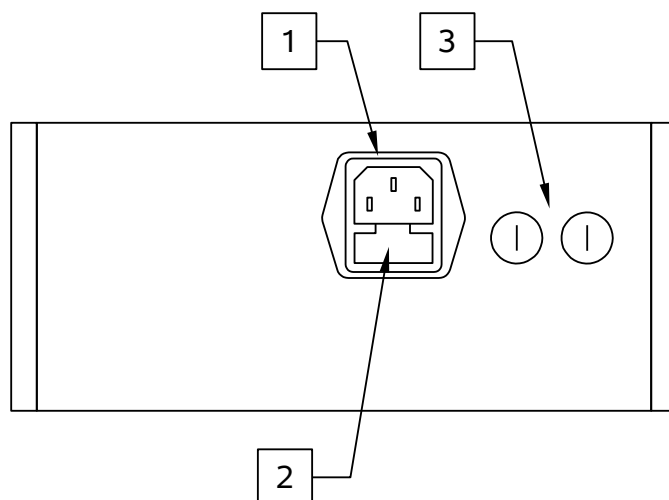

1. AC POWER INPUT. An IEC-320 C14 three-pronged recessed male socket is provided on the back panel for AC power connection to the instrument. One end of the detachable power cord that is supplied with the instrument plugs into this socket.
2. AC FUSE DRAWER. The two fuses that protect the AC input are located in this drawer. Please see the “FUSES” section of this manual for more information.
3. DC FUSES. These two fuses protect the internal DC power supplies. Please see the “FUSES” sections of this manual for more information.

GENERAL INFORMATION

BASIC CONTROL

The AV-144C3-PS amplifier accepts TTL-level input pulses (i.e., low = 0V, high = +3 to +5V), and generates +30V output pulses. The output pulse width is nominally equal to the input pulse width. The output amplitude is not adjustable.

The required voltage input signal is applied at the "IN" connector.

This is illustrated below:

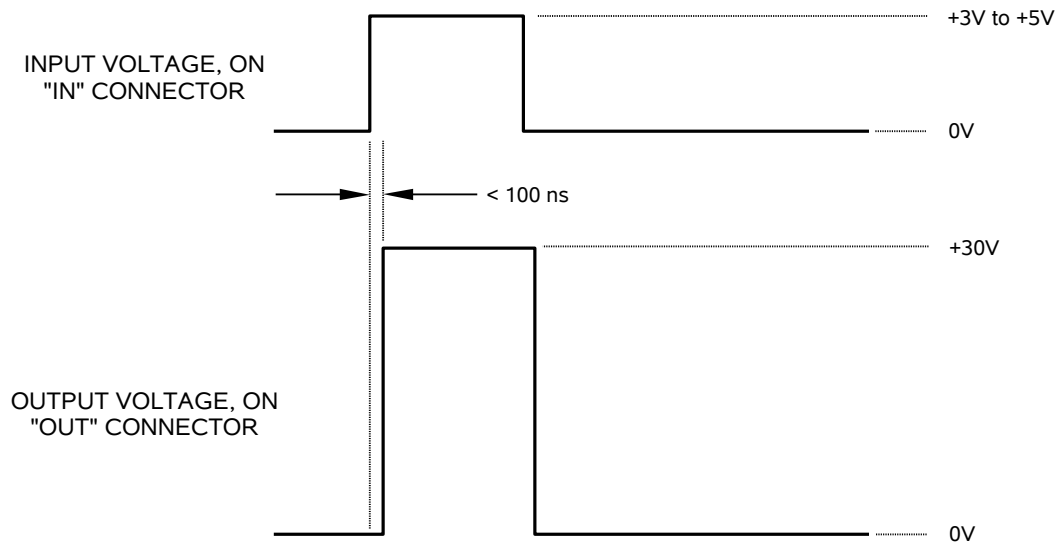

LIMITATIONS

The maximum pulse repetition frequency is 1 MHz. Higher repetition rates may damage the internal circuitry, due to thermal overstresses.

INPUT IMPEDANCE

The input impedance of standard models is $\geq 1 \text{ k}\Omega$. Units with the -Z50 option has a reduced input impedance of 50Ω .

On standard models, the cabling to the input should be kept as short as possible. It is possible that transmission line reflections may occur on the input cabling due to impedance mismatches. The magnitude of the reflections may be enough to trigger the TTL input circuitry.

If this false triggering occurs, consider converting the input impedance to 50Ω by installing a 50Ω feed-through terminator on the input connect. The Pasternack model PE6026 is an example of a suitable terminator (<http://www.pasternack.com>). The TTL

signal source must be capable of driving 50Ω in this case, of course, and 50Ω coaxial cabling should be used. This arrangement will prevent transmission line reflections.

MECHANICAL INFORMATION

TOP COVER REMOVAL

If necessary, the interior of the instrument may be accessed by removing the four Phillips screws on the top panel. With the four screws removed, the top cover may be slid back (and off).

 Always disconnect the power cord and allow the instrument to sit unpowered for 10 minutes before opening the instrument. This will allow any internal stored charge to discharge.

There are no user-adjustable internal circuits. For repairs other than fuse replacement, please contact Avtech (info@avtechpulse.com) to arrange for the instrument to be returned to the factory for repair. Service is to be performed solely by qualified service personnel.

 Caution: High voltages are present inside the instrument during normal operation. Do not operate the instrument with the cover removed.

RACK MOUNTING

A rack mounting kit is available. The -R5 rack mount kit may be installed after first removing the one Phillips screw on the side panel adjacent to the front handle.

ELECTROMAGNETIC INTERFERENCE

To prevent electromagnetic interference with other equipment, all used outputs should be connected to shielded loads using shielded coaxial cables. Unused outputs should be terminated with shielded coaxial terminators or with shielded coaxial dust caps, to prevent unintentional electromagnetic radiation. All cords and cables should be less than 3m in length.

MAINTENANCE

REGULAR MAINTENANCE

This instrument does not require any regular maintenance.

On occasion, one or more of the four rear-panel fuses may require replacement. All fuses can be accessed from the rear panel. See the “FUSES” section for details.

CLEANING

If desired, the interior of the instrument may be cleaned using compressed air to dislodge any accumulated dust. (See the “TOP COVER REMOVAL” section for instructions on accessing the interior.) No other cleaning is recommended.

PCB 158P - LOW VOLTAGE POWER SUPPLY, 1/3

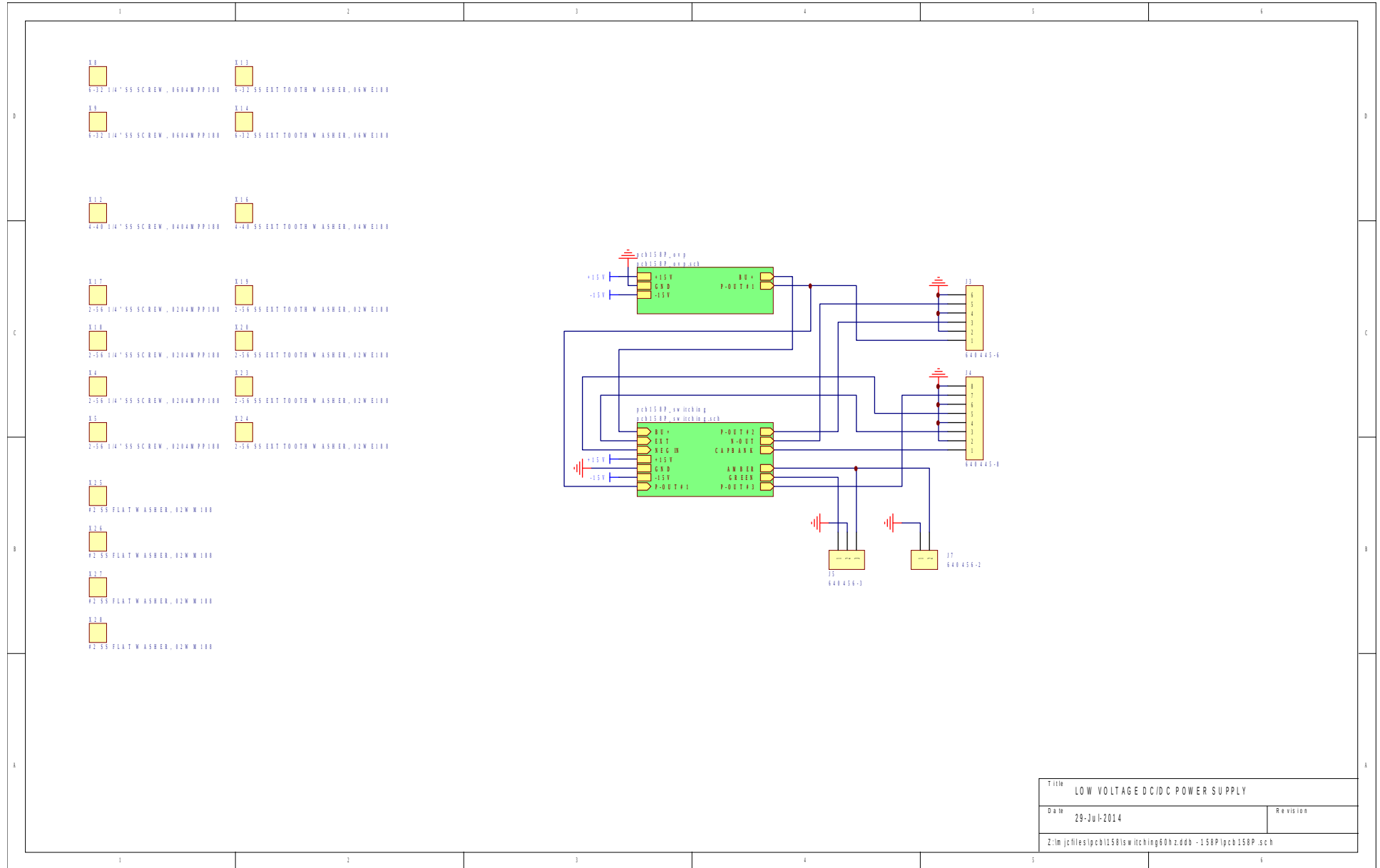

Title		LOW VOLTAGE DC/DC POWER SUPPLY
Date	29-Jul-2014	Revision
Z:\m\jcf\files\pcb\158\sw\hching60hz.ddb - 158P\pcb 158P.sch		

PCB 218A - SUPPLEMENTARY DC/DC CONVERTER

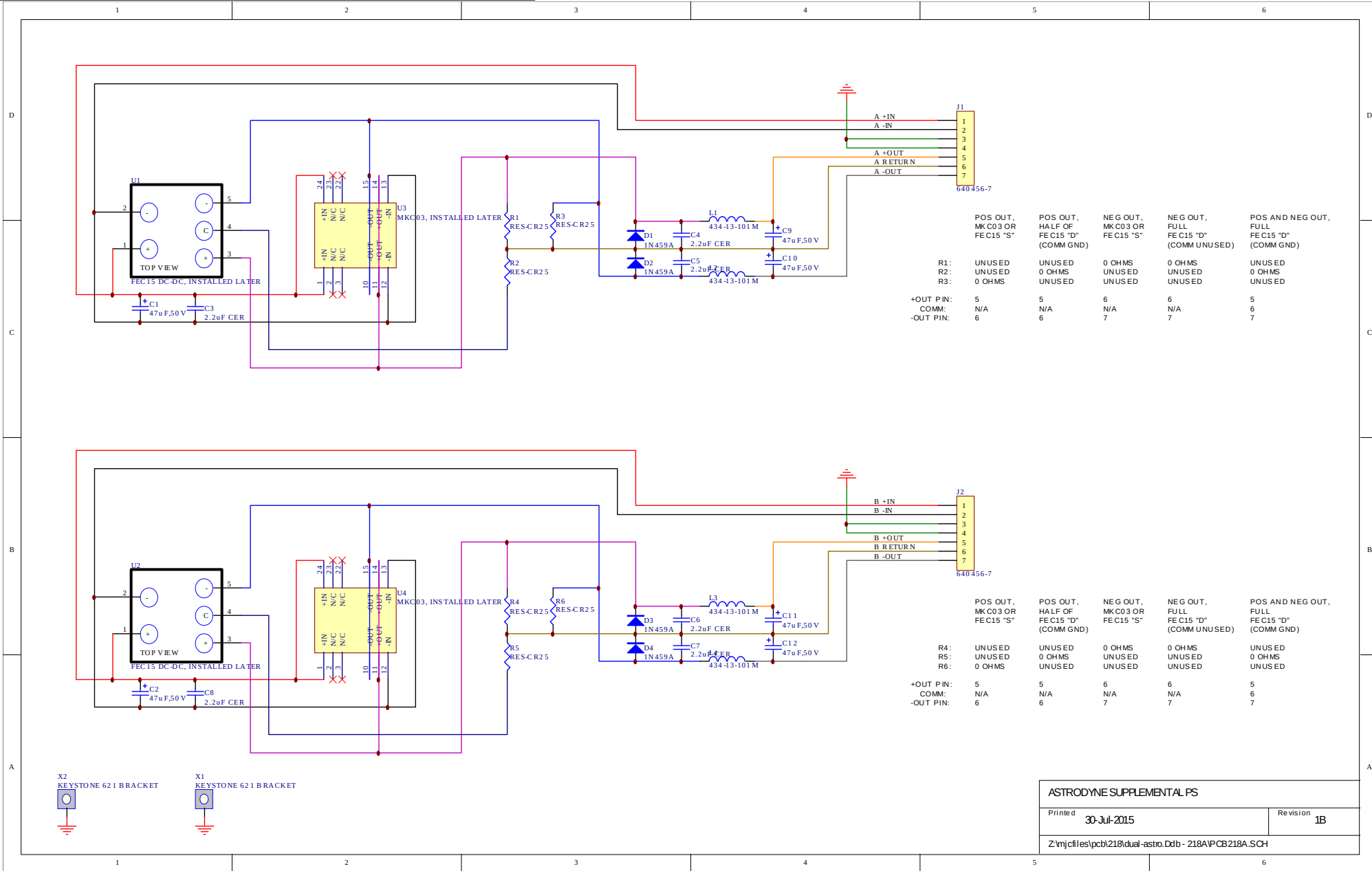

	POS OUT, MKC03 OR FEC15 "S"	POS OUT, HALF OF FEC15 "D" (COMM GND)	NEG OUT, MKC03 OR FEC15 "S"	NEG OUT, FULL FEC15 "D" (COMM UNUSED)	POS AND NEG OUT, FULL FEC15 "D" (COMM GND)
R1:	UNUSED	UNUSED	0 OHMS	0 OHMS	UNUSED
R2:	UNUSED	UNUSED	0 OHMS	0 OHMS	UNUSED
R3:	0 OHMS	UNUSED	UNUSED	UNUSED	UNUSED
+OUT PIN:	5	5	6	6	5
COMM:	N/A	N/A	N/A	N/A	6
-OUT PIN:	6	6	7	7	7

	POS OUT, MKC03 OR FEC15 "S"	POS OUT, HALF OF FEC15 "D" (COMM GND)	NEG OUT, MKC03 OR FEC15 "S"	NEG OUT, FULL FEC15 "D" (COMM UNUSED)	POS AND NEG OUT, FULL FEC15 "D" (COMM GND)
R4:	UNUSED	UNUSED	0 OHMS	0 OHMS	UNUSED
R5:	UNUSED	UNUSED	0 OHMS	0 OHMS	UNUSED
R6:	0 OHMS	UNUSED	UNUSED	UNUSED	UNUSED
+OUT PIN:	5	5	6	6	5
COMM:	N/A	N/A	N/A	N/A	6
-OUT PIN:	6	6	7	7	7

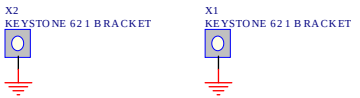

ASTRODYNE SUPPLEMENTAL PS	
Printed	30-Jul-2015
	Revision 1B
Z:\mjcfiles\pcb\218A\astro.Ddb - 218A\PCB218A.SCH	

PCB 287A - TTL INPUT PROTECTION

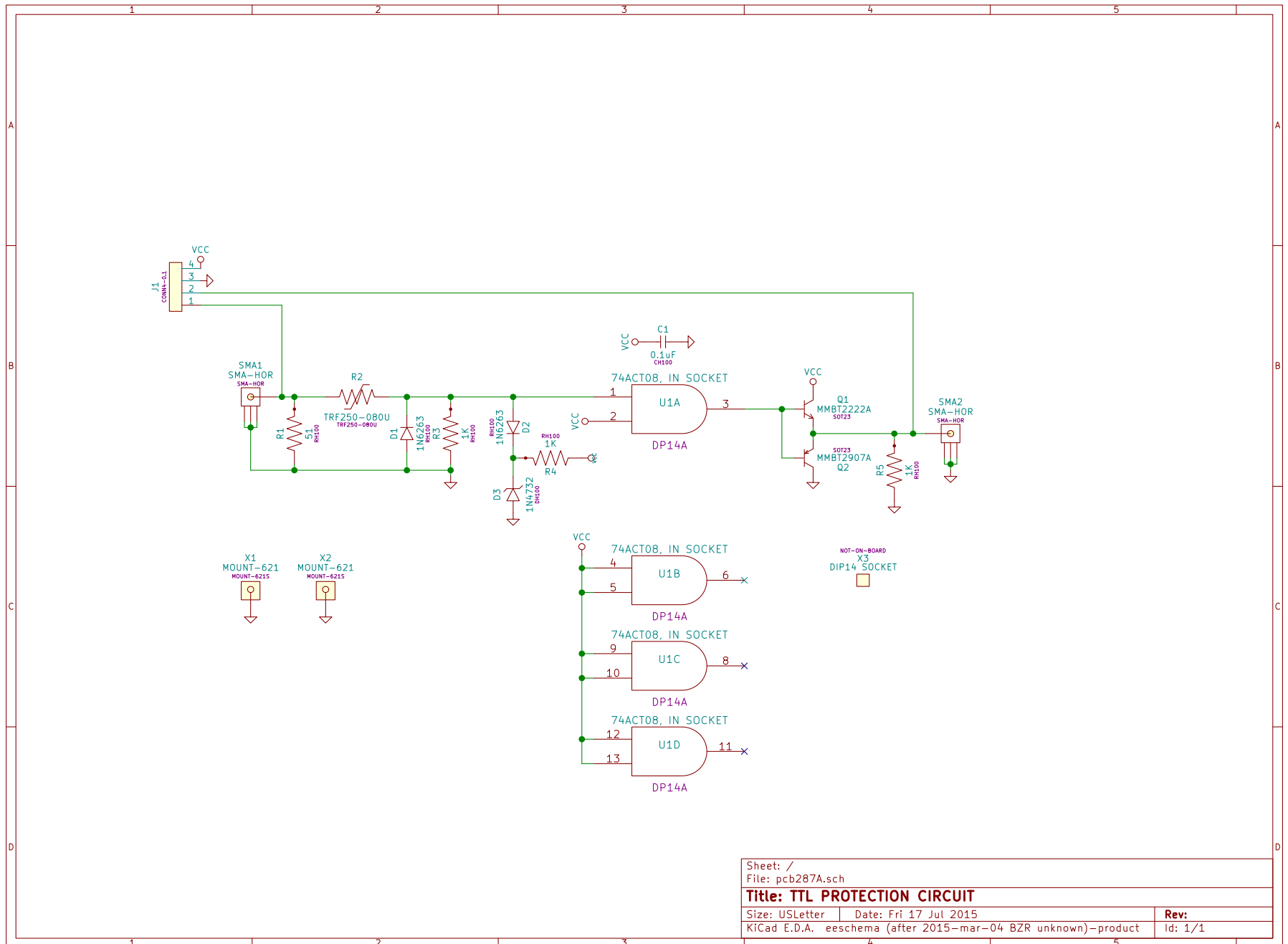

Sheet: /		File: pcb287A.sch	
Title: TTL PROTECTION CIRCUIT			
Size: USLetter	Date: Fri 17 Jul 2015	Rev:	
KiCad E.D.A. eeschema (after 2015-mar-04 BZR unknown)-product	Id: 1/1		

PERFORMANCE CHECK SHEET