

INSTRUCTIONS

MODEL AV-151J-C

0 to ± 400 V AMPLITUDE

HIGH-VOLTAGE FUNCTION GENERATOR

AND

VARIABLE-GAIN LINEAR AMPLIFIER

SERIAL NUMBER: _____

WARRANTY

Avtech Electrosystems Ltd. warrants products of its manufacture to be free from defects in material and workmanship under conditions of normal use. If, within one year after delivery to the original owner, and after prepaid return by the original owner, this Avtech product is found to be defective, Avtech shall at its option repair or replace said defective item. This warranty does not apply to units which have been disassembled, modified or subjected to conditions exceeding the applicable specifications or ratings. This warranty is the extent of the obligation assumed by Avtech with respect to this product and no other warranty or guarantee is either expressed or implied.

TECHNICAL SUPPORT

Phone: 613-226-5772 or 1-800-265-6681

Fax: 613-226-2802 or 1-800-561-1970

E-mail: info@avtechpulse.com

World Wide Web: <http://www.avtechpulse.com>

TABLE OF CONTENTS

WARRANTY.....	2
TECHNICAL SUPPORT.....	2
TABLE OF CONTENTS.....	3
INTRODUCTION.....	4
HIGH-VOLTAGE PRECAUTIONS.....	4
SPECIFICATIONS.....	5
INSTALLATION.....	6
VISUAL CHECK.....	6
PLUGGING IN THE INSTRUMENT.....	6
FRONT PANEL CONTROLS.....	8
REAR PANEL CONTROLS.....	10
GENERAL INFORMATION.....	11
BASIC PULSE CONTROL – INTERNAL MODE.....	11
BASIC PULSE CONTROL – EXTERNAL MODE.....	12
MECHANICAL INFORMATION.....	13
TOP COVER REMOVAL.....	13
RACK MOUNTING.....	13
OPERATIONAL CHECK.....	14
MAINTENANCE.....	16
REGULAR MAINTENANCE.....	16
CLEANING.....	16
POWER SUPPLY AND FUSE REPLACEMENT.....	17
PERFORMANCE CHECK SHEET.....	19

INTRODUCTION

The Model AV-151J-C function generator can produce square, sine, and triangle wave outputs at frequencies up to 50 kHz, with amplitudes of 0 to $\pm 400\text{V}$. The AV-151J-C will drive load impedances of $10\text{ k}\Omega$ or higher.

When supplied with an external voltage input, the AV-151J-C may be used as a DC to 50 kHz variable-gain linear amplifier. The gain is variable from +1 to +200.

HIGH-VOLTAGE PRECAUTIONS

 **CAUTION:** This instrument provides output voltages as high as ± 400 Volts, so extreme caution must be employed when using this instrument. The instrument should only be used by individuals who are thoroughly skilled in high voltage laboratory techniques. The following precautions should always be observed:

- 1) Keep exposed high-voltage wiring to an absolute minimum.
- 2) Wherever possible, use shielded connectors and cabling.
- 3) Connect and disconnect loads and cables only when the amplifier is turned off.
- 4) Keep in mind that all cables, connectors, oscilloscope probes, and loads must have an appropriate voltage rating.
- 5) Do not attempt any repairs on the instrument, beyond the fuse replacement procedures described in this manual. Contact Avtech technical support (see page 2 for contact information) if the instrument requires servicing.

SPECIFICATIONS

Model:	AV-151J-C
Output amplitude	0 to ± 400 Volts
Load resistance:	≥ 10 k Ω
Internal oscillator frequency range:	5 Hz to 50 kHz
-3dB bandwidth (external mode):	50 kHz
Waveforms:	Sine, square, or triangle
DC offset:	0 to ± 50 V
Square wave rise time (for maximum output):	3.5 us
Ext trig mode, Input for max output:	± 2 Volts (1 k Ω input impedance)
Connectors:	BNC
Power requirement:	120/240 Volts (switchable) 50 - 60 Hz
Dimensions:	100 mm x 430 mm x 375 mm, 3.9" x 17" x 14.8" (H x W x D)

INSTALLATION

VISUAL CHECK

After unpacking the instrument, examine to ensure that it has not been damaged in shipment. Visually inspect all connectors, knobs, and handles. Confirm that a power cord is with the instrument. If the instrument has been damaged, file a claim immediately with the company that transported the instrument.

PLUGGING IN THE INSTRUMENT

Examine the rear of the instrument. There will be a male power receptacle, a fuse holder and the edge of the power selector card visible. Confirm that the power selector card is in the correct orientation.

For AC line voltages of 110-120V, the power selector card should be installed so that the "120" marking is visible from the rear of the instrument, as shown below:



For AC line voltages of 220-240V, the power selector card should be installed so that the "240" marking is visible from the rear of the instrument, as shown below:



If it is not set for the proper voltage, remove the fuse and then grasp the card with a pair of pliers and remove it. Rotate horizontally through 180 degrees. Reinstall the card and the correct fuse.

In the 120V setting, a 1.0A slow blow fuse is required. In the 240V setting, a 0.5A slow blow fuse is required.

FRONT PANEL CONTROLS

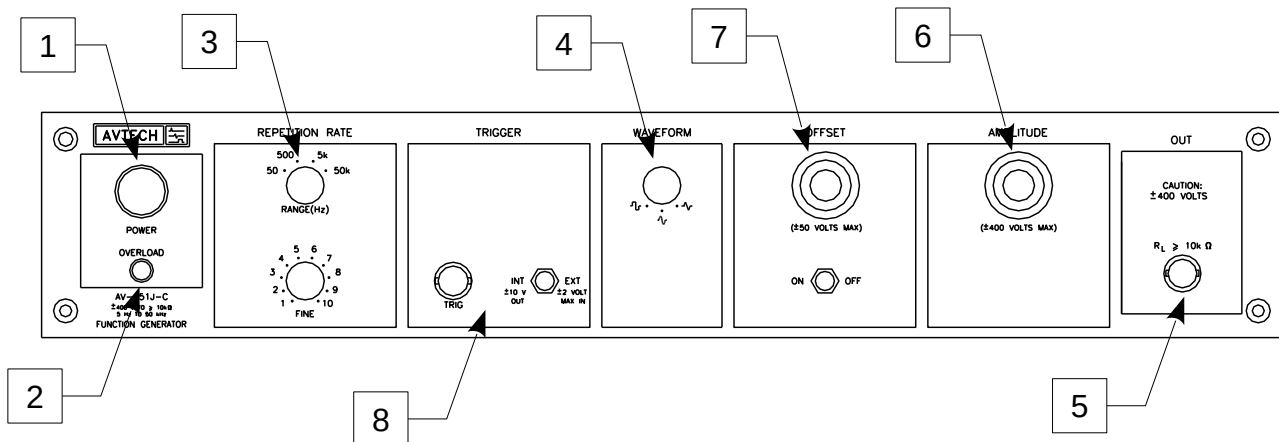

1. POWER Switch. The POWER push button switch applies AC prime power to the primaries of the transformer, turning the instrument on. The push button lamp is connected to the +15V DC supply.
2. OVERLOAD Indicator. When the instrument is powered, this indicator is normally green, indicating normal operation. If this indicator is yellow, an internal automatic overload protection circuit has been tripped. If the unit is overloaded (by operating at an exceedingly high duty cycle or by operating into a very low impedance), the protective circuit will disable the output of the instrument and turn the indicator light yellow. The light will stay yellow (i.e. output disabled) for about 5 seconds after which the instrument will attempt to re-enable the output (i.e. light green) for about 1 second. If the overload condition persists, the output will be disabled again (i.e. light yellow) for another 5 seconds. If the overload condition has been removed, the instrument will resume normal operation.

This overload indicator is only likely to come on in two situations:

- Briefly at startup. This is not a cause for concern.
- When the load impedance is too low ($< 10 \text{ k}\Omega$). In this case, turn off the instrument and connect the proper load.

3. PRF Controls. Varies output pulse repetition frequency (PRF) as follows:

Range 1	5 to 50 Hz
Range 2	50 to 500 Hz
Range 3	500 to 5000 Hz
Range 4	5 to 50 kHz

4. WAVEFORM Switch. This 3-position switch selects between square, sine or triangular output at the main output.

5. OUT Connector. This BNC connector provides the main output signal, into load impedances of $> 10 \text{ k}\Omega$. Please note that capacitances above 100 pF on the load will tend to increase the rise and fall times, and reduce the maximum operating frequency.

⚠ Caution: Voltages as high as $\pm 400\text{V}$ may be present on the center conductor of this output connector. Avoid touching this conductor. Connect to this connector using standard coaxial cable, to ensure that the center conductor is not exposed.

6. AMPLITUDE Control. This ten-turn control determines amplitude of the signal at the main output.
7. OFFSET Control. This ten-turn control allows a DC offset to be added to the signal on the main output. ON-OFF switch turns the DC offset feature on or off.
8. INT-EXT, TRIG. With this two-position is switch in the INT position, the frequency and shape of the main output are determined by controls (2) and (3).

Also, in this position a ± 10 Volt square wave (with an output impedance of $1 \text{ k}\Omega$) is provided at the TRIG BNC connector for the purpose of triggering a scope. This output can drive 50 Ohm loads, but the voltage will be reduced to $\pm 0.5\text{V}$.

When the two-position switch is in the EXT position, the AV-151J-C may be used as a DC-50 kHz variable-gain voltage-to-current converter/amplifier. The gain is variable from +1 to +100. The required input signal is applied to the TRIG connector for this mode of operation.

REAR PANEL CONTROLS

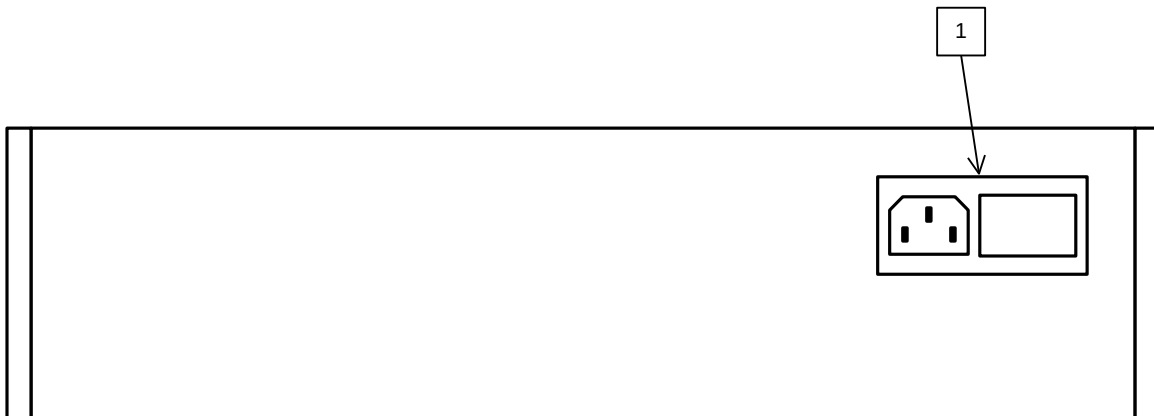

1. AC POWER INPUT. A three-pronged recessed male connector is provided on the back panel for AC power connection to the instrument. Also contained in this assembly is a slow-blow fuse and a removable power selector card that can be removed and repositioned to switch between 110-120V AC in and 220-240V.

For AC line voltages of 110-120V, the power selector card should be installed so that the "120" marking is visible from the rear of the instrument.

For AC line voltages of 220-240V, the power selector card should be installed so that the "240" marking is visible from the rear of the instrument.

If it is not set for the proper voltage, remove the fuse and then grasp the card with a pair of pliers and remove it. Rotate horizontally through 180 degrees. Reinstall the card and the correct fuse.

In the 120V setting, a 1.0A slow blow fuse is required. In the 240V setting, a 0.5A slow-blow fuse is required.

GENERAL INFORMATION

BASIC PULSE CONTROL – INTERNAL MODE

Operation in the internal mode is straightforward. The output may be set to be a triangle, sine, or square wave, as illustrated below:

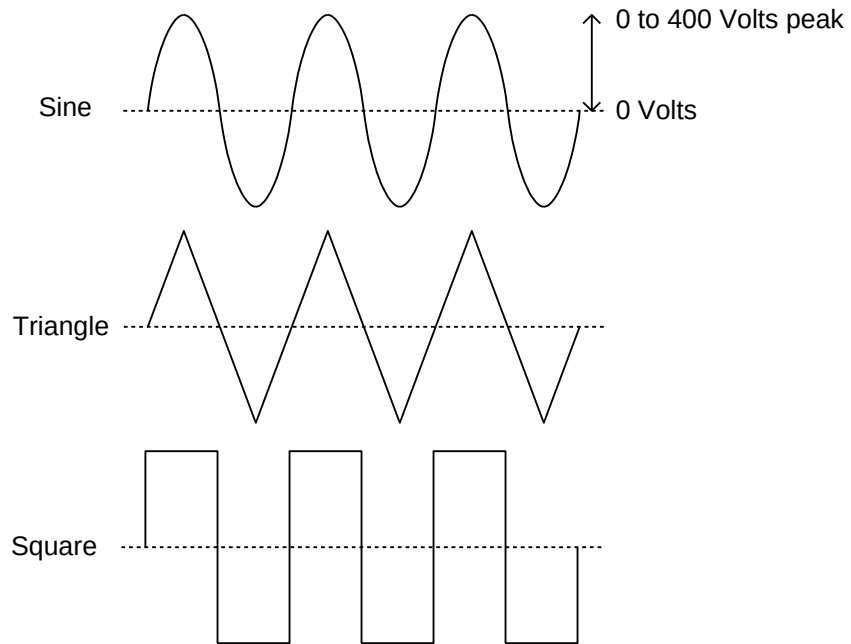

A DC offset may also be added:

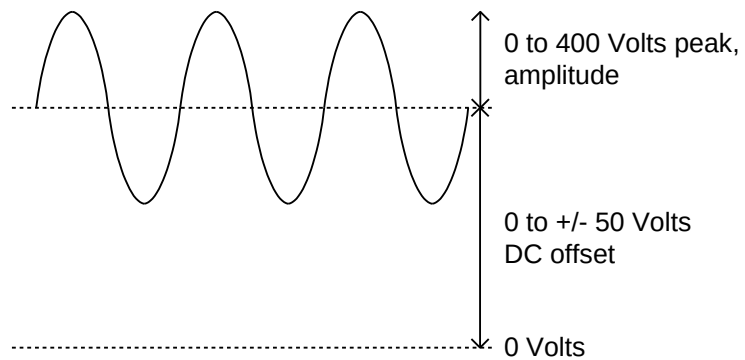

The total output (i.e., the sum of the offset and the amplitude) may not exceed $\pm 400\text{V}$.

BASIC PULSE CONTROL – EXTERNAL MODE

When the “INT/EXT” switch is in the “EXT” position, the AV-151J-C may be used as a DC - 50 kHz variable-gain linear amplifier. The gain is variable from +1 to +200, and is adjusted by rotating the amplitude control.

The required voltage input signal is applied at TRIG for this mode of operation.

This mode is illustrated below:

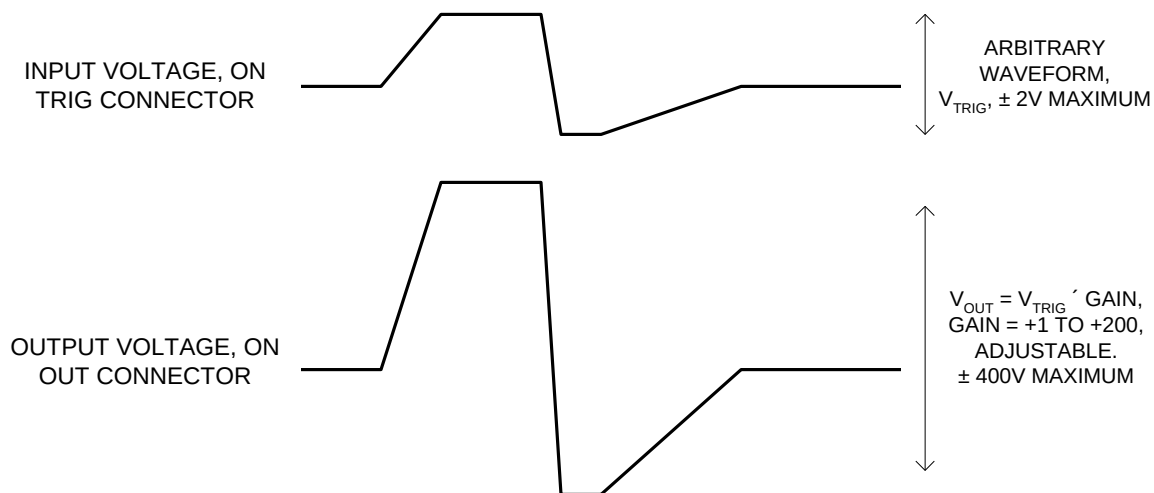

The DC offset controls do function in this mode, as described above.

MECHANICAL INFORMATION

TOP COVER REMOVAL

If necessary, the interior of the instrument may be accessed by removing the four Phillips screws on the top panel. With the four screws removed, the top cover may be slid back (and off).

Always disconnect the power cord before opening the instrument.

There are no user-adjustable internal circuits. For repairs other than fuse replacement, please contact Avtech (info@avtechpulse.com) to arrange for the instrument to be returned to the factory for repair.

⚠ Caution: High voltages are present inside the instrument during normal operation. Do not operate the instrument with the cover removed.

RACK MOUNTING

A rack mounting kit is available. The -R5 rack mount kit may be installed after first removing the one Phillips screw on the side panel adjacent to the front handle.

OPERATIONAL CHECK

This section describes a sequence to confirm the basic operation of the instrument. It should be performed after receiving the instrument. It is a useful learning exercise as well.

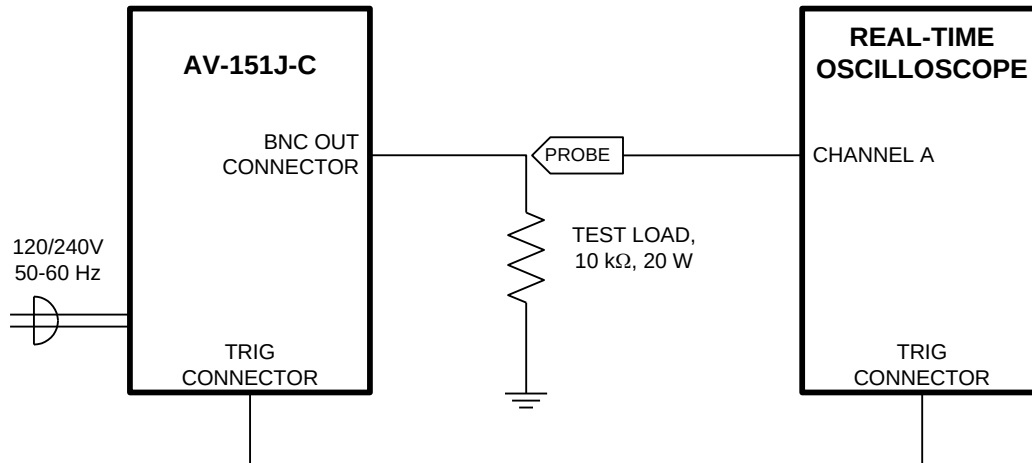

Basic Test Arrangement

- 1) Connect a 10 kΩ, 20W test load between the OUT connector and ground. Confirm that the oscilloscope and the test load are rated for 400 Volt operation. (A high-voltage probe may be required. Alternatively, the 10 kΩ test load can be constructed from two 5 kΩ, 10W resistors connected in series, and the probe can be connected between the two resistors. This will produce a 2:1 voltage divider effect.)
- 2) Connect a cable from the TRIG connector to the TRIG input of an oscilloscope. Set the oscilloscope to trigger externally.
- 3) Connect one oscilloscope probe (channel A) to the OUT load. On the oscilloscope, set the channel A vertical scale to 200 V/div, and the horizontal scale to 100 μs/div.
- 4) Set the PRF range switch to the 5 kHz range, and rotate the PRF fine control fully clockwise.
- 5) Set the INT/EXT switch to "INT".
- 6) Set the waveform switch to the sine wave position.
- 7) Turn on the AV-151J-C.
- 8) Rotate the amplitude ten-turn dial to its maximum setting.
- 9) Observe the oscilloscope. You should see a 5 kHz, ±400V sine wave.

- 10) Observe the waveform as you switch between the sine, triangle, and square wave modes using the waveform switch.
- 11) Reduce the amplitude to $\pm 100\text{V}$, using the amplitude ten-turn dial.
- 12) This completes the operational check.

If additional assistance is required:

Tel: (613) 226-5772
Fax: (613) 226-2802
Email: info@avtechpulse.com

MAINTENANCE

REGULAR MAINTENANCE

This instrument does not require any regular maintenance.

On occasion, one or more of the rear-panel fuses may require replacement. All fuses can be accessed from the rear panel.

CLEANING

If desired, the interior of the instrument may be cleaned using compressed air to dislodge any accumulated dust. (See the "TOP COVER REMOVAL" section for instructions on accessing the interior.) No other cleaning is recommended.

POWER SUPPLY AND FUSE REPLACEMENT

This instrument has three main fuses, plus two spares. One, which protects the AC input, is located in the rear-panel power entry module, as described in the “Rear Panel Controls” section of this manual. If the power appears to have failed, check the AC fuse first.

The other two fuses (plus two spares) are located on the internal DC power supply, as shown below:

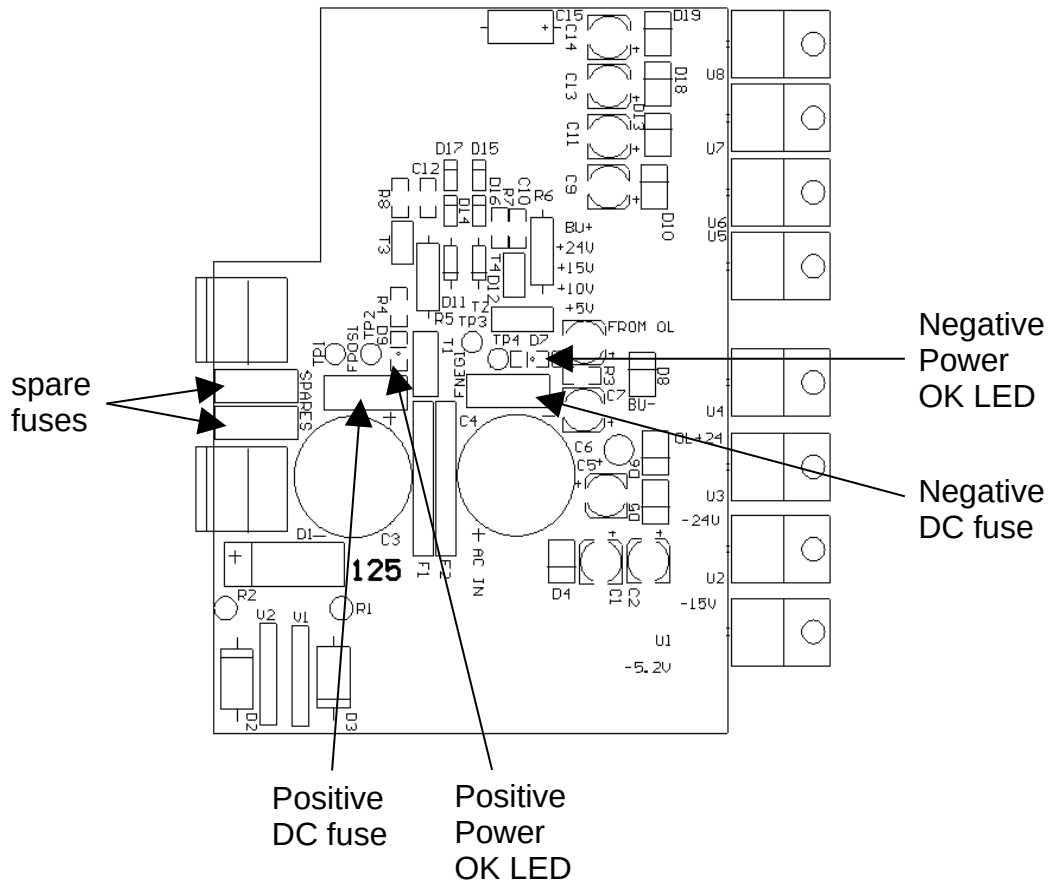

The positive fuse and one of the spare fuses on this circuit board are 2A slow-blow fuses, Littlefuse part number R45202.5. (This fuse can be ordered from Digikey, www.digikey.com. The Digikey part number is F1346CT-ND). The negative fuse and the second spare fuse are 0.5A slow-blow fuses (Littlefuse R452.500, Digikey part number F1341CT-ND).

If you suspect that the DC fuses are blown, follow this procedure:

- 1) Remove the top cover, by removing the four Phillips screws on the top cover and then sliding the cover back and off.

- 2) Locate the two "Power OK" LEDs on the power supply circuit board, as illustrated above.
- 3) Turn on the instrument.
- 4) Observe the "Power OK" LEDs. If the fuses are not blown, the two LEDs will be lit (bright red). If one of the LEDs is not lit, the fuse next to it has blown.
- 5) Turn off the instrument.
- 6) If a fuse is blown, use needle-nose pliers to remove the blown fuse from its surface-mount holder.
- 7) Replace the fuse. (Spare 2.5 Amp and 0.5 Amp fuses are provided on the circuit board. They may be transferred to the active fuse locations using needle-nose pliers.)

PERFORMANCE CHECK SHEET