



AVTECH ELECTROSYSTEMS LTD.

NANOSECOND WAVEFORM ELECTRONICS  
SINCE 1975

P.O. BOX 265  
OGDENSBURG, NY  
U.S.A. 13669-0265  
TEL: (315) 472-5270  
FAX: (613) 226-2802

TEL: 1-800-265-6681  
FAX: 1-800-561-1970

e-mail: [info@avtechpulse.com](mailto:info@avtechpulse.com)  
<http://www.avtechpulse.com/>

BOX 5120, LCD MERIVALE  
OTTAWA, ONTARIO  
CANADA K2C 3H4  
TEL: (613) 226-5772  
FAX: (613) 226-2802

## INSTRUCTIONS

MODEL AV-151J-C

0 to  $\pm 400$ V AMPLITUDE

HIGH-VOLTAGE FUNCTION GENERATOR

AND

VARIABLE-GAIN LINEAR AMPLIFIER

SERIAL NUMBER: \_\_\_\_\_

### WARRANTY

Avtech Electrosystems Ltd. warrants products of its manufacture to be free from defects in material and workmanship under conditions of normal use. If, within one year after delivery to the original owner, and after prepaid return by the original owner, this Avtech product is found to be defective, Avtech shall at its option repair or replace said defective item. This warranty does not apply to units which have been disassembled, modified or subjected to conditions exceeding the applicable specifications or ratings. This warranty is the extent of the obligation assumed by Avtech with respect to this product and no other warranty or guarantee is either expressed or implied.

### TECHNICAL SUPPORT

Phone: 613-226-5772 or 1-800-265-6681

Fax: 613-226-2802 or 1-800-561-1970

E-mail: [info@avtechpulse.com](mailto:info@avtechpulse.com)

World Wide Web: <http://www.avtechpulse.com>

## TABLE OF CONTENTS

|  |           |
|--|-----------|
| <b>WARRANTY</b> .....                                    | <b>2</b>  |
| <b>TECHNICAL SUPPORT</b> .....                           | <b>2</b>  |
| <b>TABLE OF CONTENTS</b> .....                           | <b>3</b>  |
| <b>INTRODUCTION</b> .....                                | <b>5</b>  |
| <b>HIGH-VOLTAGE PRECAUTIONS</b> .....                    | <b>5</b>  |
| <b>SPECIFICATIONS</b> .....                              | <b>6</b>  |
| <b>EC DECLARATION OF CONFORMITY</b> .....                | <b>7</b>  |
| <b>INSTALLATION</b> .....                                | <b>8</b>  |
| <b>VISUAL CHECK</b> .....                                | <b>8</b>  |
| <b>POWER RATINGS</b> .....                               | <b>8</b>  |
| <b>CONNECTION TO THE POWER SUPPLY</b> .....              | <b>8</b>  |
| <b>ENVIRONMENTAL CONDITIONS</b> .....                    | <b>9</b>  |
| <b>FUSES</b> .....                                       | <b>10</b> |
| <b>AC FUSE REPLACEMENT</b> .....                         | <b>10</b> |
| <b>DC FUSE REPLACEMENT</b> .....                         | <b>11</b> |
| <b>FUSE RATINGS</b> .....                                | <b>11</b> |
| <b>FRONT PANEL CONTROLS</b> .....                        | <b>12</b> |
| <b>REAR PANEL CONTROLS</b> .....                         | <b>14</b> |
| <b>GENERAL INFORMATION</b> .....                         | <b>15</b> |
| <b>BASIC PULSE CONTROL – INTERNAL MODE</b> .....         | <b>15</b> |
| <b>BASIC PULSE CONTROL – EXTERNAL MODE</b> .....         | <b>15</b> |
| <b>CABLE LENGTHS</b> .....                               | <b>16</b> |
| <b>OPERATIONAL CHECK</b> .....                           | <b>17</b> |
| <b>MECHANICAL INFORMATION</b> .....                      | <b>19</b> |
| <b>TOP COVER REMOVAL</b> .....                           | <b>19</b> |
| <b>RACK MOUNTING</b> .....                               | <b>19</b> |
| <b>MAINTENANCE</b> .....                                 | <b>20</b> |
| <b>REGULAR MAINTENANCE</b> .....                         | <b>20</b> |
| <b>CLEANING</b> .....                                    | <b>20</b> |
| <b>WIRING DIAGRAMS</b> .....                             | <b>0</b>  |
| <b>WIRING OF AC POWER</b> .....                          | <b>0</b>  |
| <b>PCB 158D - LOW VOLTAGE DC POWER SUPPLY, 1/3</b> ..... | <b>1</b>  |
| <b>PCB 158D - LOW VOLTAGE DC POWER SUPPLY, 2/3</b> ..... | <b>2</b>  |
| <b>PCB 158D - LOW VOLTAGE DC POWER SUPPLY, 3/3</b> ..... | <b>3</b>  |

**MAIN WIRING..... 4**  
***PERFORMANCE CHECK SHEET..... 0***

Manual Reference: /fileserver1/officefiles/instructword/av-151-153/AV-151J-C,edition2.sxw.  
Last modified February 29, 2024.  
Copyright © 2003 Avtech Electrosystems Ltd, All Rights Reserved.

## INTRODUCTION

The Model AV-151J-C function generator can produce square, sine, and triangle wave outputs at frequencies up to 50 kHz, with amplitudes of 0 to  $\pm 400\text{V}$ , and a DC offset of 0 to  $\pm 50\text{V}$ . The AV-151J-C will drive load impedances of 10 k $\Omega$  or higher.

When supplied with an external voltage input, the AV-151J-C may be used as a DC to 50 kHz variable-gain linear amplifier. The gain is variable from +1 to +200.

This instrument is intended for use in research and development laboratories.

## HIGH-VOLTAGE PRECAUTIONS

 **CAUTION:** This instrument provides output voltages as high as  $\pm 400$  Volts, so extreme caution must be employed when using this instrument. The instrument should only be used by individuals who are thoroughly skilled in high voltage laboratory techniques. The following precaution should always be observed:

- 1) Keep exposed high-voltage wiring to an absolute minimum.
- 2) Wherever possible, use shielded connectors and cabling.
- 3) Connect and disconnect loads and cables only when the amplifier is turned off.
- 4) Keep in mind that all cables, connectors, oscilloscope probes, and loads must have an appropriate voltage rating.
- 5) Do not attempt any repairs on the instrument, beyond the fuse replacement procedures described in this manual. Contact Avtech technical support (see page 2 for contact information) if the instrument requires servicing.

SPECIFICATIONS

|   |  |
|---|--|
| Model:  | AV-151J-C  |
| Maximum amplitude & maximum peak output <sup>1</sup> :  | ± 400 V  |
| Load:   | ≥ 10 kΩ  |
| Min. frequency:   | 5 Hz   |
| Max. frequency (int mode),<br>-3dB bandwidth (ext mode) | 50 kHz   |
| Waveforms:  | Sine, square, or triangle.                                     |
| DC offset:  | 0 to ±50 Volts <sup>3</sup>                                    |
| Square wave rise time <sup>2</sup> :                    | 3.5 us   |
| Ext trig mode:  | Input for maximum output: ± 2 Volts.<br>(1 kΩ input impedance) |
| Connectors:   | BNC  |
| Power requirement:                                      | 100 - 240 Volts, 50 - 60 Hz                                    |
| Dimensions:   | 100 x 430 x 375 mm (3.9" x 17" x 14.8")                        |

- 1) Peak output = amplitude + offset. The amplitude and offset can not be set to maximum at the same time, or the peak output rating will be exceeded.
- 2) The non-zero rise time will also distort the sine and triangle waveforms when operating near the maximum rated frequency.
- 3) The maximum offset may be increased to equal the "maximum peak output" rating by adding the suffix "-XOS" to the model number.

EC DECLARATION OF CONFORMITY

We

Avtech Electrosystems Ltd.  
P.O. Box 5120, LCD Merivale  
Ottawa, Ontario  
Canada K2C 3H4

declare that this pulse generator meets the intent of Directive 89/336/EEC for Electromagnetic Compatibility. Compliance pertains to the following specifications as listed in the official Journal of the European Communities:

EN 50081-1 Emission

EN 50082-1 Immunity

and that this pulse generator meets the intent of the Low Voltage Directive 72/23/EEC as amended by 93/68/EEC. Compliance pertains to the following specifications as listed in the official Journal of the European Communities:

EN 61010-1:2001 Safety requirements for electrical equipment for measurement, control, and laboratory use



## INSTALLATION

### VISUAL CHECK

After unpacking the instrument, examine to ensure that it has not been damaged in shipment. Visually inspect all connectors, knobs, and handles. Confirm that a power cord is with the instrument. If the instrument has been damaged, file a claim immediately with the company that transported the instrument.

### POWER RATINGS

This instrument is intended to operate from 100 - 240 V, 50 - 60 Hz.

The maximum power consumption is 90 Watts. Please see the “FUSES” section for information about the appropriate AC and DC fuses.

This instrument is an “Installation Category II” instrument, intended for operation from a normal single-phase supply.

### CONNECTION TO THE POWER SUPPLY

An IEC-320 three-pronged recessed male socket is provided on the back panel for AC power connection to the instrument. One end of the detachable power cord that is supplied with the instrument plugs into this socket. The other end of the detachable power cord plugs into the local mains supply. Use only the cable supplied with the instrument. The mains supply must be earthed, and the cord used to connect the instrument to the mains supply must provide an earth connection. (The supplied cord does this.) The table below describes the power cord that is supplied with this instrument, depending on the destination region:

| Destination Region                    | Description                             | Volex<br>( <a href="http://www.volex.com">http://www.volex.com</a><br>) Part Number | Newark<br>( <a href="http://www.newark.com">http://www.newark.com</a> )<br>Stock Number |
|---------------------------------------|---|---|---|
| Continental Europe                    | European CEE 7/7 “Schuko”<br>230V, 50Hz | 17850-C3-326  | 44F1841   |
| United Kingdom                        | BS 1363, 230V, 50Hz                     | 17962-C3-10   | 84F1025   |
| Switzerland                           | SEV 1011, 230V, 50Hz                    | 2102H-C3-10   | 93F2452   |
| Israel                                | SI 32, 220V, 50Hz                       | 2115H-C3-10   | 04F1115   |
| North America,<br>and all other areas | NEMA 5-15, 120V, 60 Hz                  | 17250-B1-10   | 36F1255   |



## ENVIRONMENTAL CONDITIONS

This instrument is intended for use under the following conditions:

1. indoor use;
2. altitude up to 2 000 m;
3. temperature 5 °C to 40 °C;
4. maximum relative humidity 80 % for temperatures up to 31 °C decreasing linearly to 50 % relative humidity at 40 °C;
5. Mains supply voltage fluctuations up to  $\pm 10$  % of the nominal voltage;
6. no pollution or only dry, non-conductive pollution.

## FUSES

This instrument contains four fuses. All are accessible from the rear-panel. Two protect the AC prime power input, and two protect the internal DC power supplies. The locations of the fuses on the rear panel are shown in the figure below:

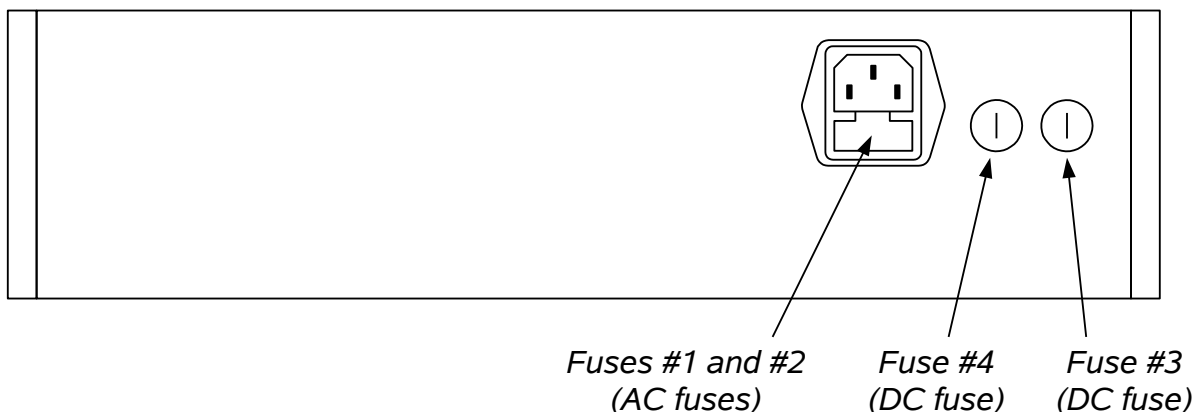

### AC FUSE REPLACEMENT

To physically access the AC fuses, the power cord must be detached from the rear panel of the instrument. The fuse drawer may then be extracted using a small flat-head screwdriver, as shown below:

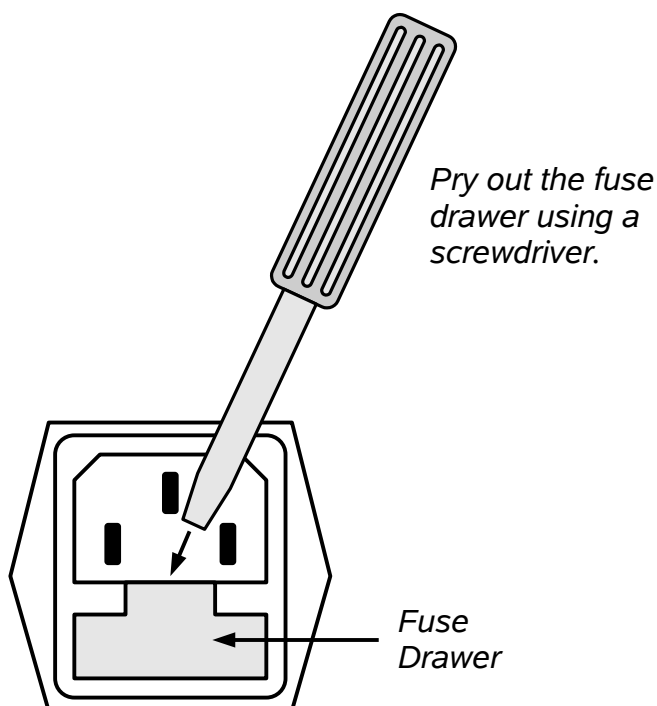

## DC FUSE REPLACEMENT

The DC fuses may be replaced by inserting the tip of a flat-head screwdriver into the fuse holder slot, and rotating the slot counter-clockwise. The fuse and its carrier will then pop out.

## FUSE RATINGS

The following table lists the required fuses:

| Fuses       | Nominal Mains Voltage | Rating                 | Case Size | Manufacturer's Part Number (Wickmann) | Distributor's Part Number (Digi-Key) |
|-------------|-----------------------|------------------------|-----------|---------------------------------------|--------------------------------------|
| #1, #2 (AC) | 115 V                 | 0.8A, 250V, Time-Delay | 5×20 mm   | 1950800000                            | WK5046-ND                            |
|             | 230 V                 | 0.5A, 250V, Time-Delay | 5×20 mm   | 1950500000                            | WK5041-ND                            |
| #3 (DC)     | N/A                   | 2.5A, 250V, Time-Delay | 5×20 mm   | 1951250000                            | WK5058-ND                            |
| #4 (DC)     | N/A                   | 2.0A, 250V, Time-Delay | 5×20 mm   | 1951200000                            | WK5057-ND                            |

The fuse manufacturer is Wickmann (<http://www.wickmann.com/>).

Replacement fuses may be easily obtained from Digi-Key (<http://www.digikey.com/>) and other distributors.

## FRONT PANEL CONTROLS

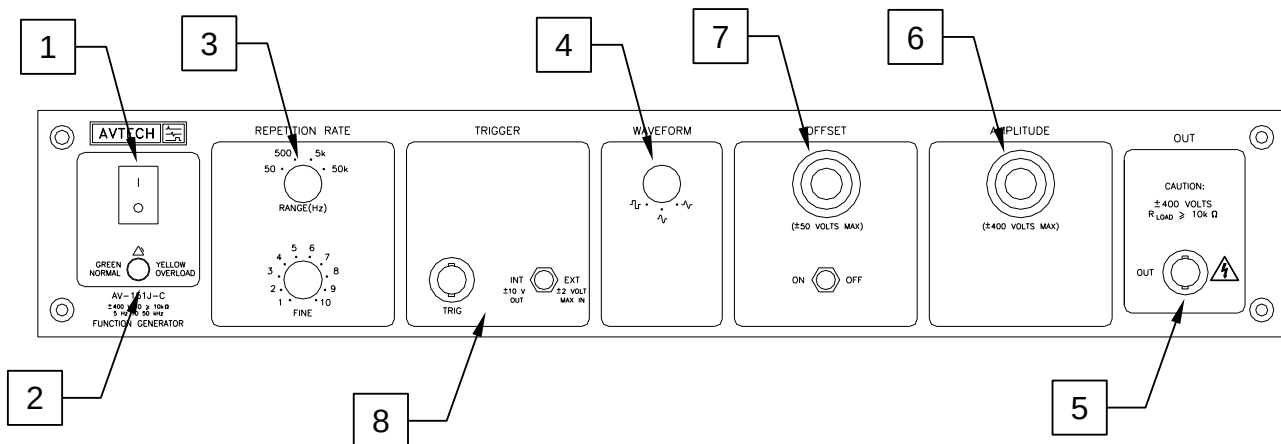

1. **POWER Switch**. This is the main power switch. When turning the instrument on, there may be a delay of several seconds before the instrument appears to respond.
2. **OVERLOAD Indicator**. When the instrument is powered, this indicator is normally green, indicating normal operation. If this indicator is yellow, an internal automatic overload protection circuit has been tripped. If the unit is overloaded (by operating at an exceedingly high duty cycle or by operating into a very low impedance), the protective circuit will disable the output of the instrument and turn the indicator light yellow. The light will stay yellow (i.e. output disabled) for about 5 seconds after which the instrument will attempt to re-enable the output (i.e. light green) for about 1 second. If the overload condition persists, the output will be disabled again (i.e. light yellow) for another 5 seconds. If the overload condition has been removed, the instrument will resume normal operation.

This overload indicator is only likely to come on in two situations:

- Briefly at startup. This is not a cause for concern.
- When the load impedance is too low ( $< 10 \text{ k}\Omega$ ). In this case, turn off the instrument and connect the proper load.

3. **REPETITION RATE Controls**. Varies output pulse repetition frequency (PRF) as follows:

|         |              |
|---------|--------------|
| Range 1 | 5 to 50 Hz   |
| Range 2 | 50 to 500 Hz |
| Range 3 | 0.5 to 5 kHz |
| Range 4 | 5 to 50 kHz  |

4. **WAVEFORM Switch**. This 3-position switch selects between square, sine or triangular output at the main output.

5. OUT Connector. This BNC connector provides the main output signal, into load impedances of  $\geq 10 \text{ k}\Omega$ .

 Caution: Voltages as high as  $\pm 400\text{V}$  may be present on the center conductor of this output connector. Avoid touching this conductor. Connect to this connector using standard coaxial cable, to ensure that the center conductor is not exposed.

6. AMPLITUDE Control. This ten-turn control determines amplitude of the signal at the main output.
7. OFFSET Control. This ten-turn control allows a DC offset to be added to the signal on the main output. ON-OFF switch turns the DC offset feature on or off.
8. INT-EXT, TRIG. With this two-position switch in the INT position, the frequency and shape of the main output are determined by the REPETITION RATE controls.

Also, in this position a  $\pm 10$  Volt square wave (with an output impedance of  $1 \text{ k}\Omega$ ) is provided at the TRIG BNC connector for the purpose of triggering a scope. This output can drive  $50 \text{ Ohm}$  loads, but the voltage will be reduced to  $\pm 0.5\text{V}$ .

When the two-position switch is in the EXT position, the AV-151J-C may be used as a DC-50 kHz variable-gain voltage-to-current converter/amplifier. The gain is variable from +1 to +200. The required input signal is applied to the TRIG connector for this mode of operation.

## REAR PANEL CONTROLS

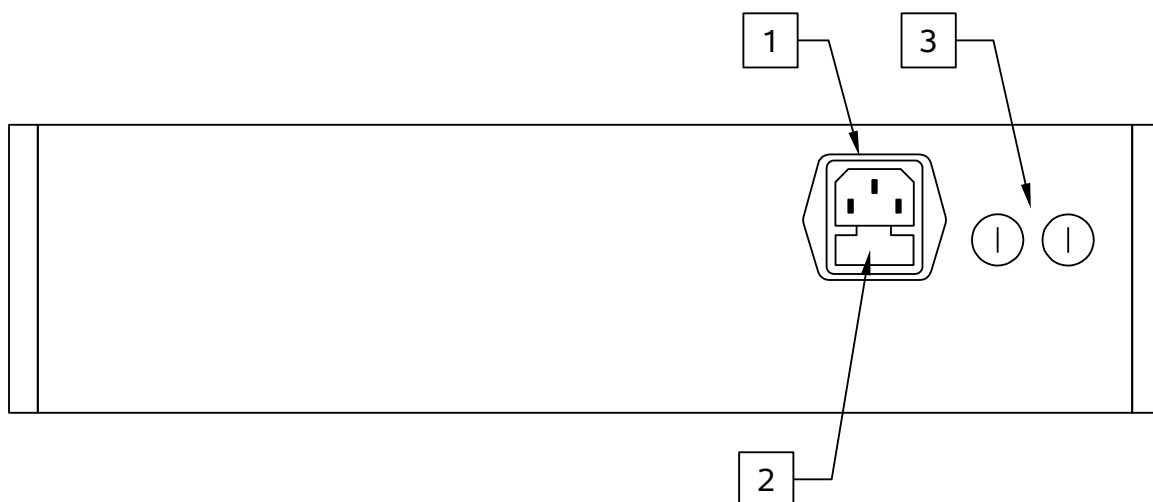

1. AC POWER INPUT. An IEC-320 C14 three-pronged recessed male socket is provided on the back panel for AC power connection to the instrument. One end of the detachable power cord that is supplied with the instrument plugs into this socket.
2. AC FUSE DRAWER. The two fuses that protect the AC input are located in this drawer. Please see the “FUSES” section of this manual for more information.
3. DC FUSES. These two fuses protect the internal DC power supplies. Please see the “FUSES” sections of this manual for more information.

## GENERAL INFORMATION

### BASIC PULSE CONTROL – INTERNAL MODE

Operation in the internal mode is straightforward. The output may be set to be a triangle, sine, or square wave, as illustrated below:

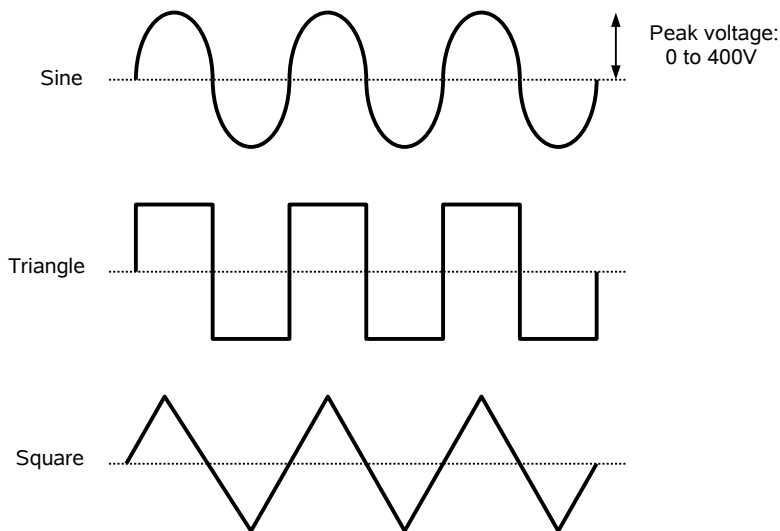

A DC offset in the range of  $\pm 50\text{V}$  (or  $\pm 400\text{V}$  for units with the -XOS option) may also be added:

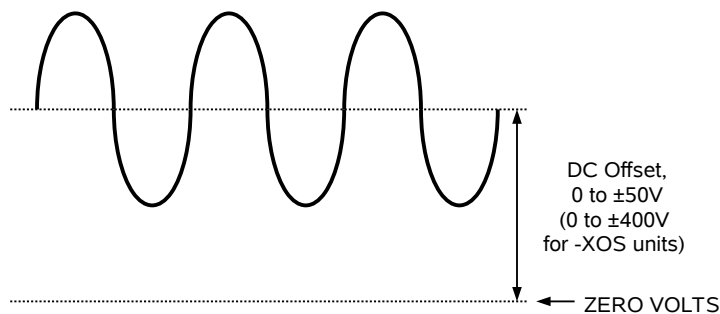

The total output (i.e., the sum of the offset and the amplitude) may not exceed  $\pm 400\text{V}$ .

### BASIC PULSE CONTROL – EXTERNAL MODE

When the "INT/EXT" switch is in the "EXT" position, the AV-151J-C may be used as a DC-50 kHz variable-gain linear amplifier. The gain is variable from +1 to +200, and is adjusted by rotating the amplitude control.

The required voltage input signal is applied at TRIG for this mode of operation.

This mode is illustrated below:

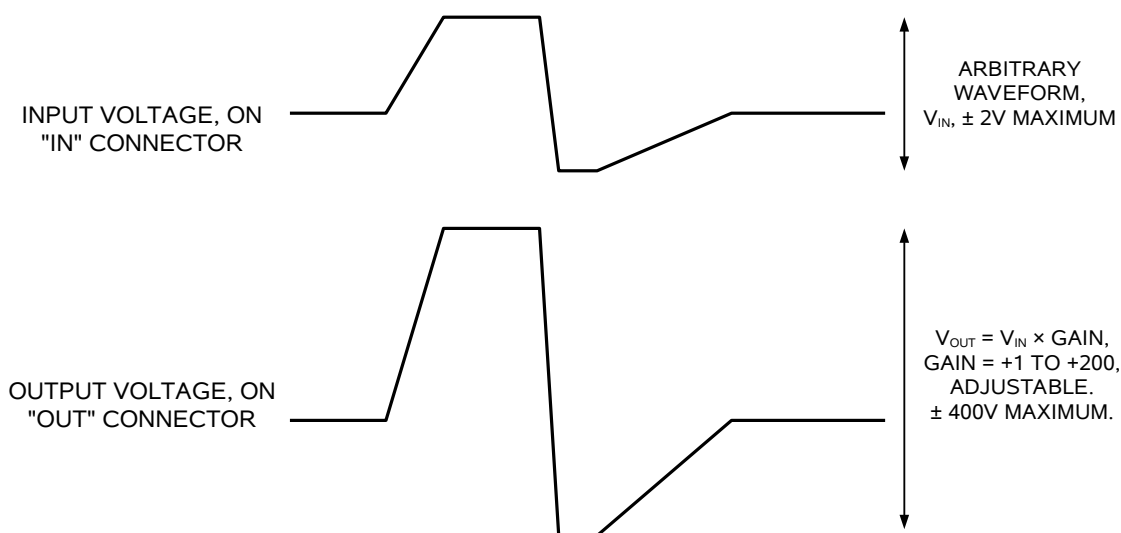

### CABLE LENGTHS

The length of cable used to connect the load to the output of the function generator should be less than 3 feet (1 meter), and ideally less than 18 inches (0.5 meters). At longer lengths, the transmission line reflections caused by the cabling will distort the output signal, particularly if the "square" waveform mode is used.



## OPERATIONAL CHECK

This section describes a sequence to confirm the basic operation of the instrument. It should be performed after receiving the instrument. It is a useful learning exercise as well.

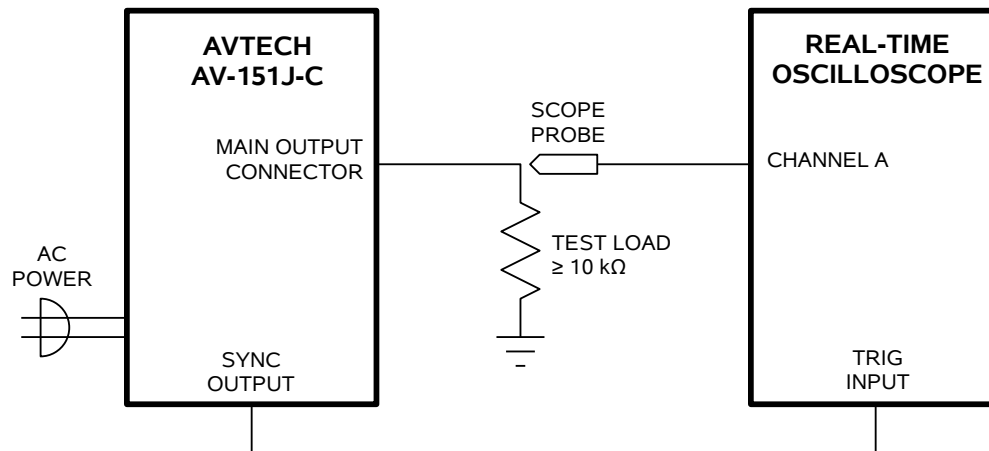

*Basic Test Arrangement*

- 1) Connect a 10 k $\Omega$ , 16 Watt test load between the OUT connector and ground. Confirm that the oscilloscope and the test load are rated for 400 Volt operation. (Factory tests are conducted using eight 10 k $\Omega$ , 2 Watt resistors connected in a series-parallel combination to create a composite fan-cooled 16 Watt resistor.)
- 2) Connect a cable from the TRIG connector to the TRIG input of an oscilloscope. Set the oscilloscope to trigger externally.
- 3) Connect one oscilloscope probe (channel A) to the OUT load. On the oscilloscope, set the channel A vertical scale to 200 V/div, and the horizontal scale to 100 us/div.
- 4) Set the PRF range switch to the 5 kHz range, and rotate the PRF fine control fully clockwise.
- 5) Set the INT/EXT switch to "INT".
- 6) Set the waveform switch to the sine wave position.
- 7) Turn on the AV-151J-C.
- 8) Rotate the amplitude ten-turn dial to its maximum setting.
- 9) Observe the oscilloscope. You should see a 5 kHz,  $\pm 400$ V sine wave.
- 10) Observe the waveform as you switch between the sine, triangle, and square wave modes using the waveform switch.

11) Reduce the amplitude to  $\pm 100\text{V}$ , using the amplitude ten-turn dial.

12) This completes the operational check.

If additional assistance is required:

Tel: (613) 226-5772

Fax: (613) 226-2802

Email: [info@avtechpulse.com](mailto:info@avtechpulse.com)

## MECHANICAL INFORMATION

### TOP COVER REMOVAL

If necessary, the interior of the instrument may be accessed by removing the four Phillips screws on the top panel. With the four screws removed, the top cover may be slid back (and off).

Always disconnect the power cord before opening the instrument.

There are no user-adjustable internal circuits. For repairs other than fuse replacement, please contact Avtech ([info@avtechpulse.com](mailto:info@avtechpulse.com)) to arrange for the instrument to be returned to the factory for repair.

 Caution: High voltages are present inside the instrument during normal operation. Do not operate the instrument with the cover removed.

### RACK MOUNTING

A rack mounting kit is available. The -R5 rack mount kit may be installed after first removing the one Phillips screw on the side panel adjacent to the front handle.

## MAINTENANCE

### REGULAR MAINTENANCE

This instrument does not require any regular maintenance.

On occasion, one or more of the rear-panel fuses may require replacement. All fuses can be accessed from the rear panel.

### CLEANING

If desired, the interior of the instrument may be cleaned using compressed air to dislodge any accumulated dust. (See the “TOP COVER REMOVAL” section for instructions on accessing the interior.) No other cleaning is recommended.

# WIRING DIAGRAMS

## WIRING OF AC POWER

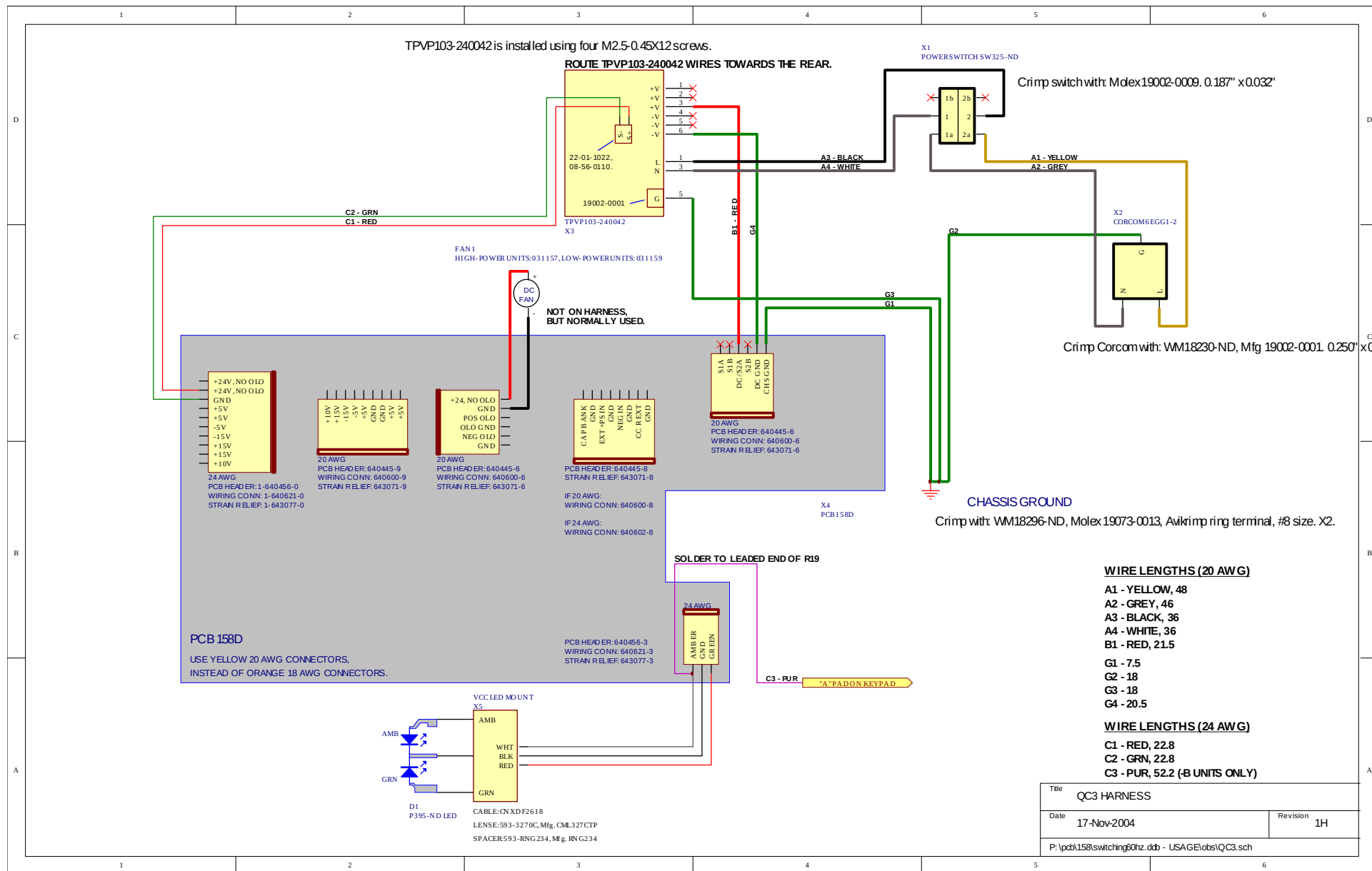

# PCB 158D - LOW VOLTAGE DC POWER SUPPLY, 1/3

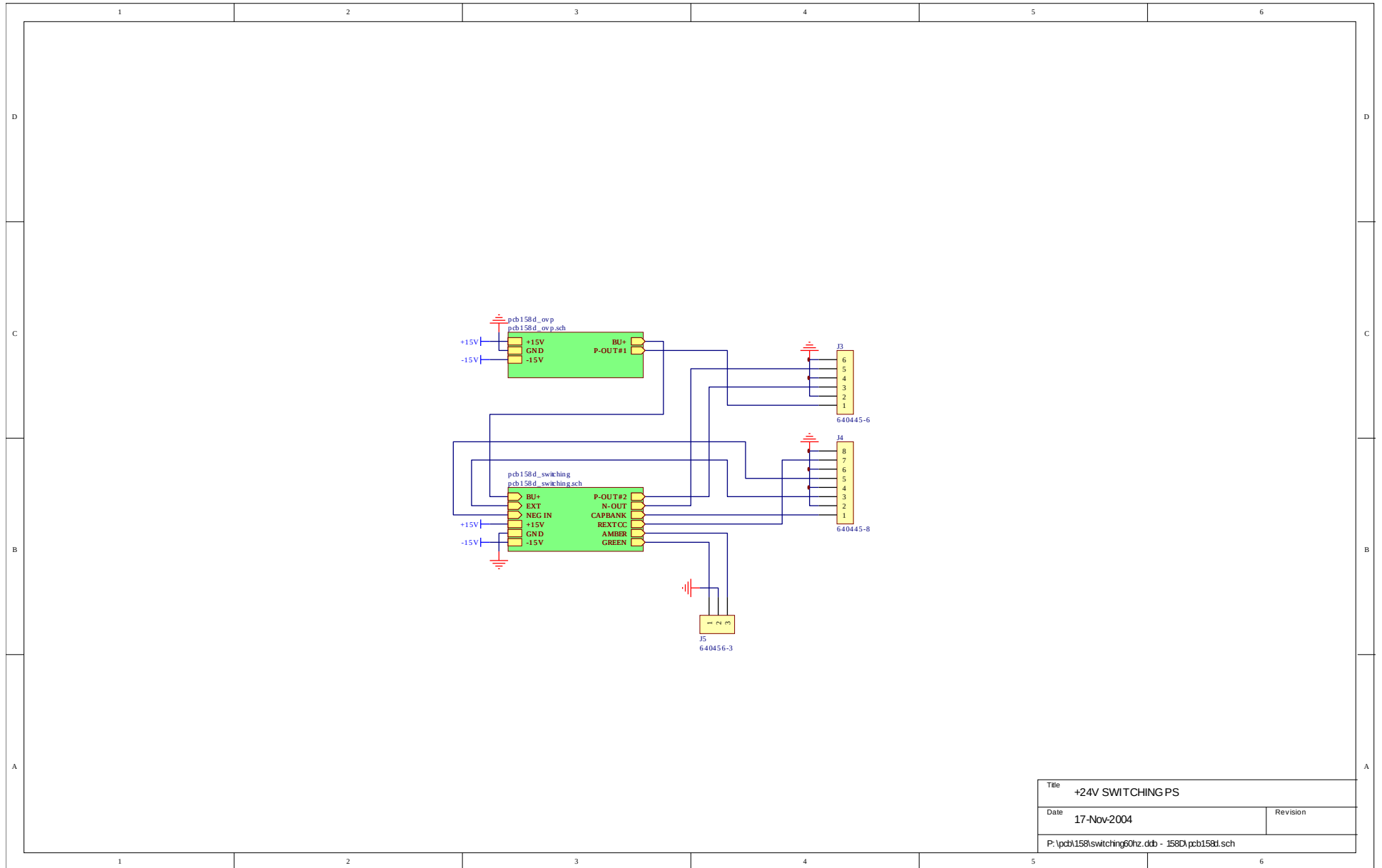

|  |                   |          |
|--|-------------------|----------|
| Title  | +24V SWITCHING PS |          |
| Date   | 17-Nov-2004       | Revision |
| P:\pcb\158d\switching60hz.ddb - 158D.pcb158d.sch |                   |          |



# PCB 158D - LOW VOLTAGE DC POWER SUPPLY, 3/3

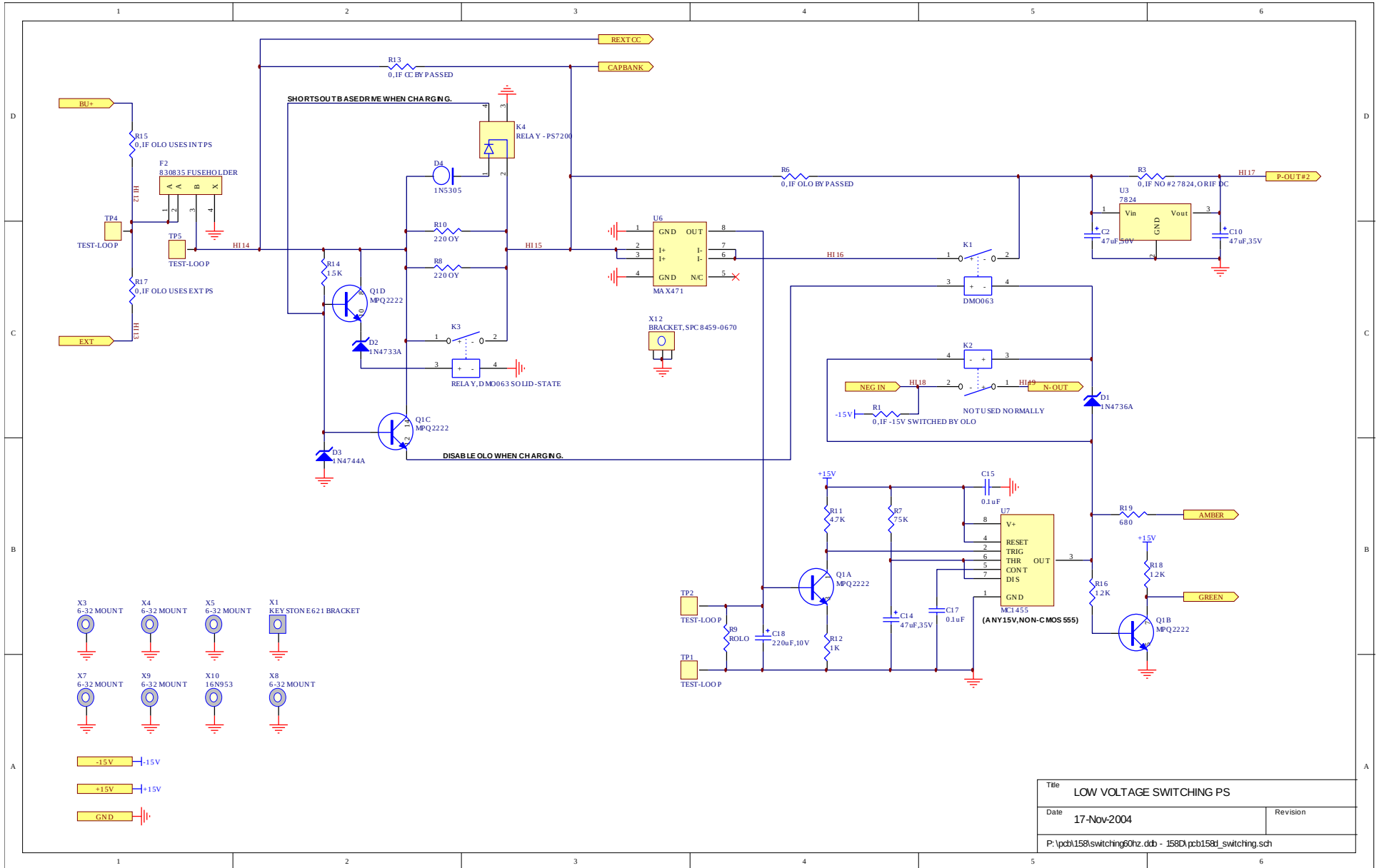



# MAIN WIRING

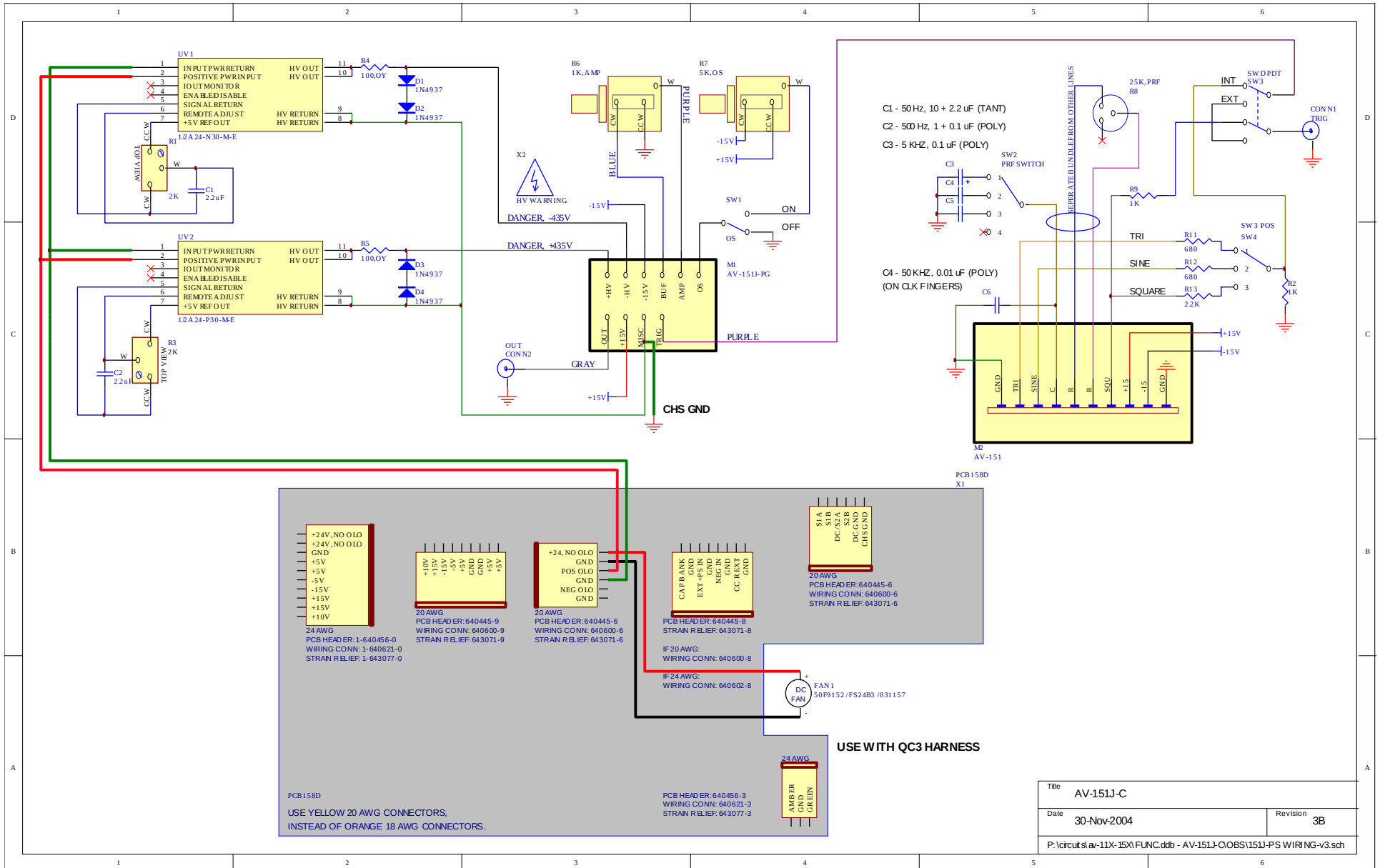

PERFORMANCE CHECK SHEET