

INSTRUCTIONS

MODEL AV-151A-C-GUA

0 to ± 50 V AMPLITUDE,
0 TO ± 450 V DC OFFSET

HIGH-VOLTAGE
FUNCTION GENERATOR
and
VARIABLE-GAIN
LINEAR AMPLIFIER

SERIAL NUMBER: _____

WARRANTY

Avtech Electrosystems Ltd. warrants products of its manufacture to be free from defects in material and workmanship under conditions of normal use. If, within one year after delivery to the original owner, and after prepaid return by the original owner, this Avtech product is found to be defective, Avtech shall at its option repair or replace said defective item. This warranty does not apply to units which have been disassembled, modified or subjected to conditions exceeding the applicable specifications or ratings. This warranty is the extent of the obligation assumed by Avtech with respect to this product and no other warranty or guarantee is either expressed or implied.

TECHNICAL SUPPORT

Phone: 613-226-5772 or 1-800-265-6681

Fax: 613-226-2802 or 1-800-561-1970

E-mail: info@avtechpulse.com

World Wide Web: <http://www.avtechpulse.com>

TABLE OF CONTENTS

WARRANTY.....	2
TECHNICAL SUPPORT.....	2
TABLE OF CONTENTS.....	3
INTRODUCTION.....	4
HIGH-VOLTAGE PRECAUTIONS.....	4
SPECIFICATIONS.....	5
ORIGINAL QUOTATION.....	6
INSTALLATION.....	7
VISUAL CHECK.....	7
PLUGGING IN THE INSTRUMENT.....	7
FRONT PANEL CONTROLS.....	8
REAR PANEL CONTROLS.....	10
GENERAL INFORMATION.....	11
BASIC PULSE CONTROL – INTERNAL MODE.....	11
BASIC PULSE CONTROL – EXTERNAL MODE.....	12
MECHANICAL INFORMATION.....	13
TOP COVER REMOVAL.....	13
RACK MOUNTING.....	13
OPERATIONAL CHECK.....	14
MAINTENANCE.....	16
REGULAR MAINTENANCE.....	16
CLEANING.....	16
PERFORMANCE CHECK SHEET.....	17

INTRODUCTION

The Model AV-151A-C-GUA function generator can produce square, sine, and triangle wave outputs at frequencies up to 3 kHz, with amplitudes of 0 to $\pm 50V$, and a DC offset of 0 to $\pm 450V$. The AV-151A-C-GUA will drive load impedances of 100 k Ω or higher.

When supplied with an external voltage input, the AV-151A-C-GUA may be used as a DC to 3 kHz variable-gain linear amplifier. The gain is variable from +1 to +25.

HIGH-VOLTAGE PRECAUTIONS

 **CAUTION:** This instrument provides output voltages as high as ± 500 Volts, so extreme caution must be employed when using this instrument. The instrument should only be used by individuals who are thoroughly skilled in high voltage laboratory techniques. The following precaution should always be observed:

- 1) Keep exposed high-voltage wiring to an absolute minimum.
- 2) Wherever possible, use shielded connectors and cabling.
- 3) Connect and disconnect loads and cables only when the amplifier is turned off.
- 4) Keep in mind that all cables, connectors, oscilloscope probes, and loads must have an appropriate voltage rating.
- 5) Do not attempt any repairs on the instrument, beyond the fuse replacement procedures described in this manual. Contact Avtech technical support (see page 2 for contact information) if the instrument requires servicing.

SPECIFICATIONS

Model:	AV-151A-C-GUA
Output amplitude (max):	± 50 Volts
Load impedance:	≥ 100 k Ω
Internal oscillator frequency range:	0.3 Hz to 3 kHz
-3dB bandwidth, external mode	3 kHz
Waveforms:	sine, square, triangle
DC offset:	± 450 Volts
Rise time (for max output):	< 35 μ s
Ext trig mode:	Input amplitude for maximum output: ± 2 Volts
Connectors:	BNC
Power requirement:	120/240 Volts (switchable) 50 - 60 Hz
Dimensions:	100 mm x 430 mm x 375 mm (3.9" x 17" x 14.8")

ORIGINAL QUOTATION

To: Ron Dombro
 Guidant
 651-582-7836
 ron.dombro@guidant.com

Ron,

Following our telephone conversation, I am pleased to quote as follows:

Quote number: 11421

Model number: AV-151A-C-GUA

Description: High-Voltage Function Generator

Amplitude: Variable from 0 to 100V peak-to-peak (-GUA option)

DC offset: Variable from 0 to +/- 450V DC (-GUA option)

Other: as per the standard AV-151A-C. See
<http://www.avtechpulse.com/function/av-151a/> for details.

Price: \$4911 US, FOB destination.

Delivery: 30 days after receipt of order.

Please call or email me if I can be of further assistance.

Regards,
 Dr. Michael J. Chudobiak
 VP, New Product Development

--- Avtech Electrosystems Ltd. ----- since 1975 ---

PO Box 265	ph: 1-800-265-6681 or 613-226-5772	Box 5120 Stn. F
Ogdensburg, NY	fax: 1-800-561-1970 or 613-226-2802	Ottawa, Ontario
USA 13669-0265	email: info@avtechpulse.com	Canada K2C 3H4
	http://www.avtechpulse.com/	

Nanosecond Waveform Generators
 for general purpose, R&D and OEM applications

Pulse Generators - Laser Diode Drivers - Pulse Amplifiers
 Impulse Generators - Current Pulsers - Delay Generators - Splitters
 Function Generators - Monocycle Generators - Frequency Dividers + more!

INSTALLATION

VISUAL CHECK

After unpacking the instrument, examine to ensure that it has not been damaged in shipment. Visually inspect all connectors, knobs, and handles. Confirm that a power cord is with the instrument. If the instrument has been damaged, file a claim immediately with the company that transported the instrument.

PLUGGING IN THE INSTRUMENT

Examine the rear of the instrument. There will be a male power receptacle, a fuse holder and the edge of the power selector card visible.

For AC line voltages of 110-120V, the power selector card should be installed so that the "120" marking is visible from the rear of the instrument.

For AC line voltages of 220-240V, the power selector card should be installed so that the "240" marking is visible from the rear of the instrument.

If it is not set for the proper voltage, remove the fuse and then grasp the card with a pair of pliers and remove it. Rotate horizontally through 180 degrees. Reinstall the card and the correct fuse.

In the 120V setting, a 0.5A slow-blow fuse is required. In the 240V setting, a 0.25A slow-blow fuse is required.

FRONT PANEL CONTROLS

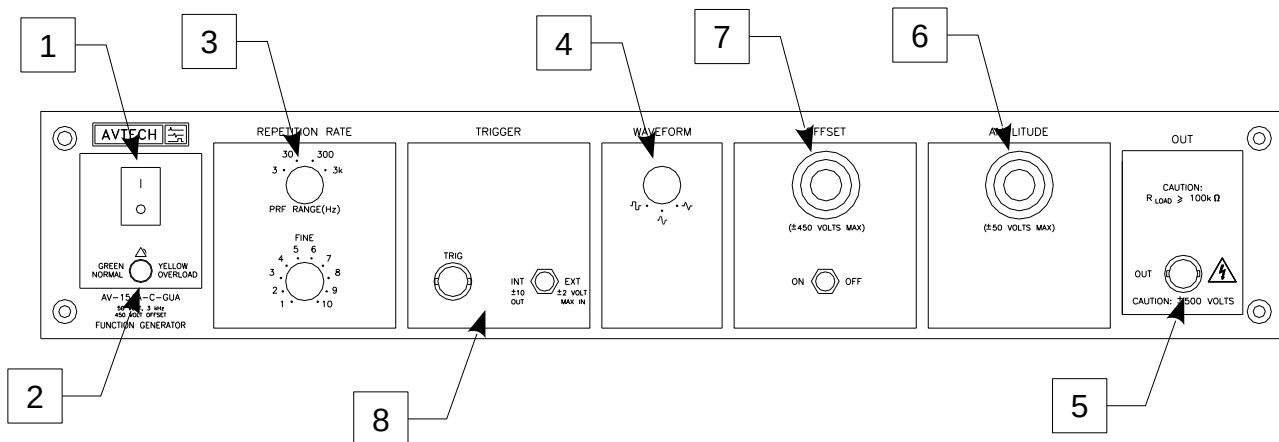

- 1. POWER Switch.** The POWER push button switch applies AC prime power to the primaries of the transformer, turning the instrument on. The push button lamp is connected to the +15V DC supply.
- 2. OVERLOAD Indicator.** When the instrument is powered, this indicator is normally green, indicating normal operation. If this indicator is yellow, an internal automatic overload protection circuit has been tripped. If the unit is overloaded (by operating at an exceedingly high duty cycle or by operating into a very low impedance), the protective circuit will disable the output of the instrument and turn the indicator light yellow. The light will stay yellow (i.e. output disabled) for about 5 seconds after which the instrument will attempt to re-enable the output (i.e. light green) for about 1 second. If the overload condition persists, the output will be disabled again (i.e. light yellow) for another 5 seconds. If the overload condition has been removed, the instrument will resume normal operation.

This overload indicator is only likely to come on in two situations:

- Briefly at startup. This is not a cause for concern.
- When the load impedance is too low ($< 100 \text{ k}\Omega$). In this case, turn off the instrument and connect the proper load.

- 3. PRF Controls.** Varies output pulse repetition frequency (PRF) as follows:

Range 1	35 to 350 Hz
Range 2	350 to 3500 Hz
Range 3	3.5 to 35 KHz
Range 4	35 to 350 KHz

- 4. WAVEFORM Switch.** This 3-position switch selects between square, sine or triangular output at the main output.

5. OUT Connector. This BNC connector provides the main output signal, into load impedances of $> 100 \text{ k}\Omega$.

⚠ Caution: Voltages as high as $\pm 500\text{V}$ may be present on the center conductor of this output connector. Avoid touching this conductor. Connect to this connector using standard coaxial cable, to ensure that the center conductor is not exposed.

6. AMPLITUDE Control. This ten-turn control determines amplitude of the signal at the main output.
7. OFFSET Control. This ten-turn control allows a DC offset to be added to the signal on the main output. ON-OFF switch turns the DC offset feature on or off.
8. INT-EXT, TRIG. With this two-position is switch in the INT position, the frequency and shape of the 0.35 Hz to 3 kHz component on the main output are determined by controls (2) and (3).

Also, in this position a ± 10 Volt square wave (with an output impedance of $1 \text{ k}\Omega$) is provided at the TRIG BNC connector for the purpose of triggering a scope. This output can drive 50 Ohm loads, but the voltage will be reduced to $\pm 0.5\text{V}$.

When the two-position switch is in the EXT position, the AV-151A-C-GUA may be used as a DC-3 kHz variable-gain voltage-to-current converter/amplifier. The gain is variable from +1 to +25. The required input signal is applied to the TRIG connector for this mode of operation.

REAR PANEL CONTROLS

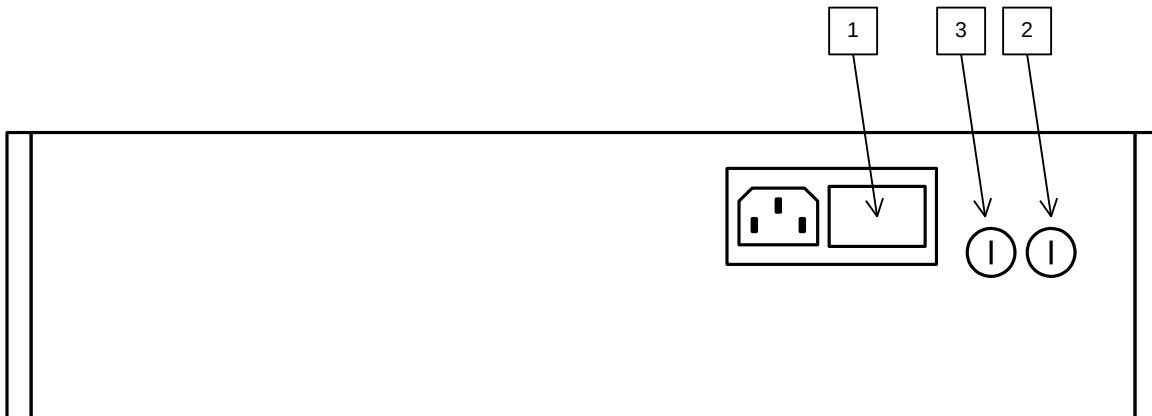

1. AC POWER INPUT. A three-pronged recessed male connector is provided on the back panel for AC power connection to the instrument. Also contained in this assembly is a slow-blow fuse and a removable power selector card that can be removed and repositioned to switch between 110-120V AC in and 220-240V.

For AC line voltages of 110-120V, the power selector card should be installed so that the “120” marking is visible from the rear of the instrument.

For AC line voltages of 220-240V, the power selector card should be installed so that the “240” marking is visible from the rear of the instrument.

If it is not set for the proper voltage, remove the fuse and then grasp the card with a pair of pliers and remove it. Rotate horizontally through 180 degrees. Reinstall the card and the correct fuse.

In the 120V setting, a 0.5A slow blow fuse is required. In the 240V setting, a 0.25A slow-blow fuse is required.

2. DC Fuse. This 1.0A slow-blow fuse protects the internal DC power supplies.
3. DC Fuse. This 0.8A slow-blow fuse protects the internal DC power supplies.

GENERAL INFORMATION

BASIC PULSE CONTROL – INTERNAL MODE

Operation in the internal mode is straightforward. The output may be set to be a triangle, sine, or square wave, as illustrated below:

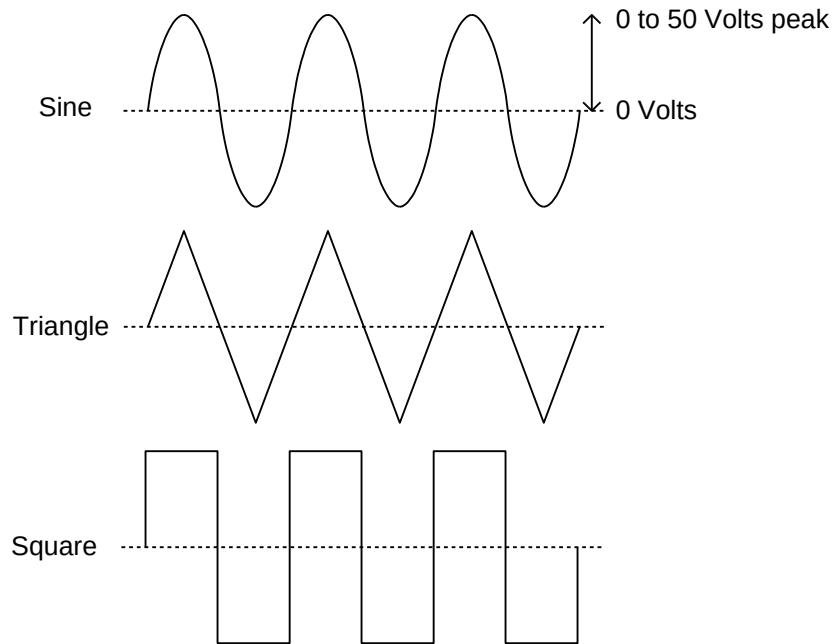

A DC offset may also be added:

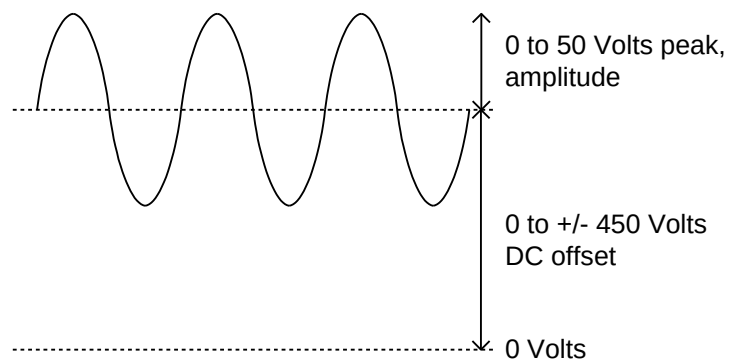

The total output (i.e., the sum of the offset and the amplitude) may not exceed $\pm 500\text{V}$.

BASIC PULSE CONTROL – EXTERNAL MODE

When the “INT/EXT” switch is in the “EXT” position, the AV-151A-C-GUA may be used as a DC - 3 kHz variable-gain linear amplifier. The gain is variable from +1 to +25, and is adjusted by rotating the amplitude control.

The required voltage input signal is applied at TRIG for this mode of operation.

This mode is illustrated below:

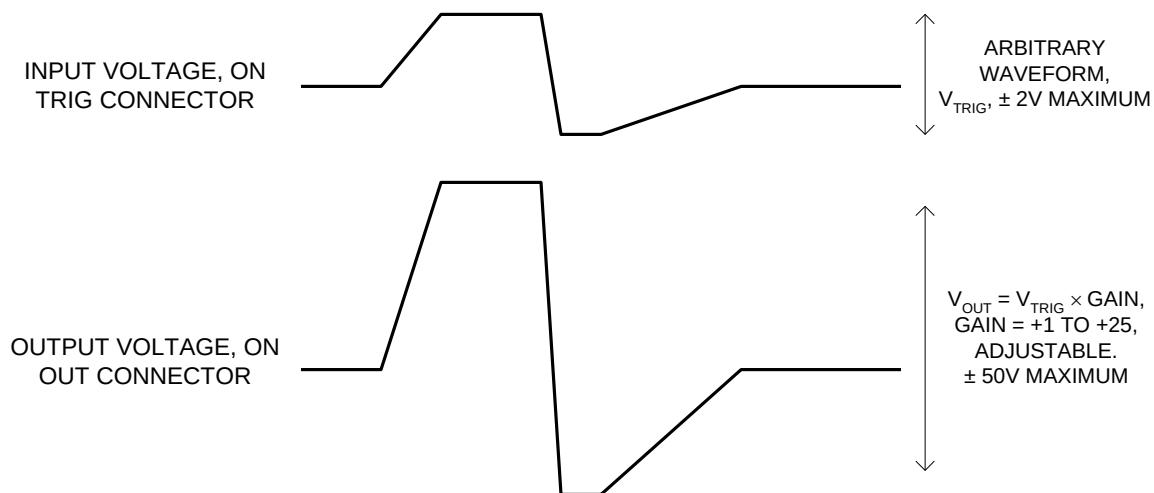

The DC offset controls do function in this mode, as described above.

MECHANICAL INFORMATION

TOP COVER REMOVAL

If necessary, the interior of the instrument may be accessed by removing the four Phillips screws on the top panel. With the four screws removed, the top cover may be slid back (and off).

Always disconnect the power cord before opening the instrument.

There are no user-adjustable internal circuits. For repairs other than fuse replacement, please contact Avtech (info@avtechpulse.com) to arrange for the instrument to be returned to the factory for repair.

⚠ Caution: High voltages are present inside the instrument during normal operation. Do not operate the instrument with the cover removed.

RACK MOUNTING

A rack mounting kit is available. The -R5 rack mount kit may be installed after first removing the one Phillips screw on the side panel adjacent to the front handle.

OPERATIONAL CHECK

This section describes a sequence to confirm the basic operation of the instrument. It should be performed after receiving the instrument. It is a useful learning exercise as well.

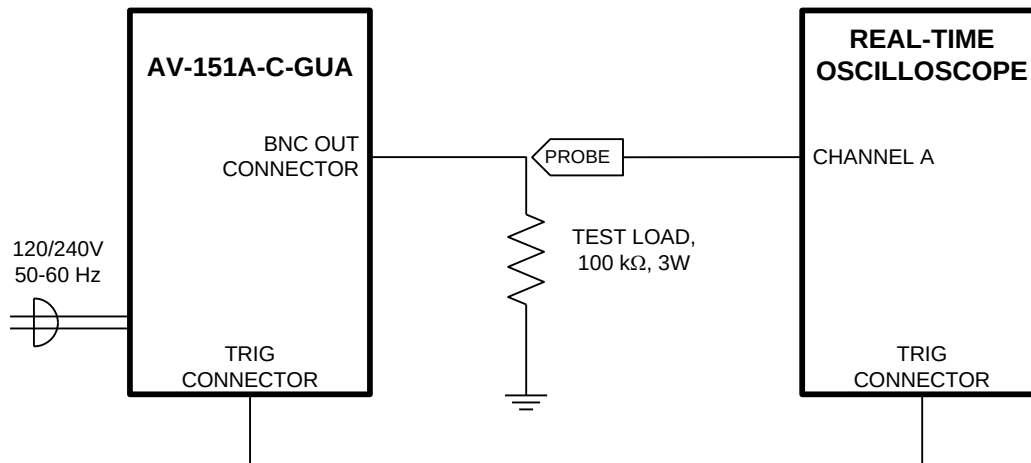

Basic Test Arrangement

- 1) Connect a 100 kΩ, 3W test load between the OUT connector and ground. Confirm that the oscilloscope and the test load are rated for +/- 500 Volt operation.
- 2) Connect a cable from the TRIG connector to the TRIG input of an oscilloscope. Set the oscilloscope to trigger externally.
- 3) Connect one oscilloscope probe (channel A) to the OUT load. On the oscilloscope, set the channel A vertical scale to 100 V/div, and the horizontal scale to 50 μs/div.
- 4) Set the PRF range switch to the 3 kHz range, and rotate the PRF fine control fully clockwise.
- 5) Set the INT/EXT switch to "INT".
- 6) Set the waveform switch to the sine wave position.
- 7) Set the Offset ON/OFF switch to "OFF".
- 8) Turn on the AV-151A-C-GUA.
- 9) Rotate the amplitude ten-turn dial to its maximum setting.
- 10) Observe the oscilloscope. You should see a 3 kHz, ±50V sine wave.

- 11) Observe the waveform as you switch between the sine, triangle, and square wave modes using the waveform switch.
- 12) Switch the Offset ON/OFF switch to "ON", and rotate the offset ten-turn dial. The output waveform should shift vertically on the oscilloscope.
- 13) This completes the operational check.

If additional assistance is required:

Tel: (613) 226-5772
Fax: (613) 226-2802
Email: info@avtechpulse.com

MAINTENANCE

REGULAR MAINTENANCE

This instrument does not require any regular maintenance.

On occasion, one or more of the rear-panel fuses may require replacement. All fuses can be accessed from the rear panel.

CLEANING

If desired, the interior of the instrument may be cleaned using compressed air to dislodge any accumulated dust. (See the "TOP COVER REMOVAL" section for instructions on accessing the interior.) No other cleaning is recommended.

PERFORMANCE CHECK SHEET