



AVTECH ELECTROSYSTEMS LTD.

NANOSECOND WAVEFORM ELECTRONICS
SINCE 1975

P.O. BOX 265
OGDENSBURG, NY
U.S.A. 13669-0265

TEL: 888-670-8729 (USA & Canada) or +1-613-226-5772 (Intl)
FAX: 800-561-1970 (USA & Canada) or +1-613-226-2802 (Intl)

info@avtechpulse.com - <http://www.avtechpulse.com/>

BOX 5120, LCD MERIVALE
OTTAWA, ONTARIO
CANADA K2C 3H4

INSTRUCTIONS

MODEL AVG-4B-N-PS-VS2A

1000 VOLT

IMPULSE GENERATOR

SERIAL NUMBER: _____

WARRANTY

Avtech Electrosystems Ltd. warrants products of its manufacture to be free from defects in material and workmanship under conditions of normal use. If, within one year after delivery to the original owner, and after prepaid return by the original owner, this Avtech product is found to be defective, Avtech shall at its option repair or replace said defective item. This warranty does not apply to units which have been disassembled, modified or subjected to conditions exceeding the applicable specifications or ratings. This warranty is the extent of the obligation assumed by Avtech with respect to this product and no other warranty or guarantee is either expressed or implied.

TECHNICAL SUPPORT

Phone: 888-670-8729 (USA & Canada) or +1-613-226-5772 (Intl)

Fax: 800-561-1970 (USA & Canada) or +1-613-226-2802 (Intl)

E-mail: info@avtechpulse.com

World Wide Web: <http://www.avtechpulse.com>

TABLE OF CONTENTS

WARRANTY.....	2
TECHNICAL SUPPORT.....	2
TABLE OF CONTENTS.....	3
INTRODUCTION.....	5
ORIGINAL QUOTATION.....	6
SPECIFICATIONS.....	8
HIGH-VOLTAGE PRECAUTIONS.....	9
EUROPEAN REGULATORY NOTES.....	10
EC DECLARATION OF CONFORMITY.....	10
DIRECTIVE 2002/95/EC (RoHS).....	10
DIRECTIVE 2002/96/EC (WEEE).....	10
INSTALLATION.....	12
VISUAL CHECK.....	12
POWER RATINGS.....	12
CONNECTION TO THE POWER SUPPLY.....	12
PROTECTION FROM ELECTRIC SHOCK.....	13
ENVIRONMENTAL CONDITIONS.....	13
FUSES.....	15
AC FUSE REPLACEMENT.....	15
DC FUSE REPLACEMENT.....	16
FUSE RATINGS.....	16
FRONT PANEL CONTROLS.....	17
REAR PANEL CONTROLS.....	19
GENERAL INFORMATION.....	20
BASIC TEST ARRANGEMENT.....	20
BASIC PULSE CONTROL.....	20
MECHANICAL INFORMATION.....	22
TOP COVER REMOVAL.....	22
RACK MOUNTING.....	22
ELECTROMAGNETIC INTERFERENCE.....	22
MAINTENANCE.....	23
REGULAR MAINTENANCE.....	23
CLEANING.....	23

WIRING DIAGRAMS.....24
 WIRING OF AC POWER.....24
 PCB 158K - LOW VOLTAGE POWER SUPPLY, 1/3.....25
 PCB 158K - LOW VOLTAGE POWER SUPPLY, 2/3.....26
 PCB 158K - LOW VOLTAGE POWER SUPPLY, 3/3.....27
 PCB 168B - HIGH VOLTAGE DC POWER SUPPLY.....28
 MAIN WIRING.....29
PERFORMANCE CHECK SHEET.....30

Manual Reference: /fileserver1/officefiles/instructword/avg/OBS/AVG-4B-N-PS-VS2A,edition1.odt.
Last modified February 29, 2024.
Copyright © 2024 Avtech Electrosystems Ltd, All Rights Reserved.

INTRODUCTION

The AVG-4B-N-PS-VS2A is a high performance instrument capable of generating narrow impulses in the range of -800V to -1000V into 50Ω loads at repetition rates up to 10 kHz. The pulse width can be adjusted over a narrow range (< 10 ns to > 13 ns, when measured at the -100V level).

The output is designed to drive 50Ω loads. (A 50Ω load is required for proper operation.) The output is AC-coupled.

This instrument is intended for use in research, development, test and calibration laboratories by qualified personnel.

ORIGINAL QUOTATION

To: Thomas F. Lynch
VP-Product Manager
Video Scope International, Ltd.
105 Executive Drive, Suite 110
Dulles, VA 20164-1727
Phone: 703-437-5534
Fax: 703-742-8947
tlynch@videoscopeintl.com

Tom,

Following your recent inquiry, I am pleased to quote as follows:

Quote number: 12026

Model number: AVG-4B-N-PS-VS2A

Description: Impulse Generator

Polarity: negative

Peak Output amplitude (fixed):

a) > -1000 Volts (to 50 Ohms).
Note that coax cable length to load should
not exceed 0.5 meter.

b) > -950 Volts to 50 Ohms shunted by 30 pF.

Pulse width:

a) At -900 Volts: 3 to 7 ns (one turn control).

b) At -100 Volts: 10 to 13 ns (one turn control).

Monitor output: Included. Provides an attenuated (x10) coincident replica of the output to a rear-panel SMA connector. Requires a 50 Ohm load.

DC offset: A +50V DC (to Rload > 10 kilohms) internally-generated offset is provided. It may be enabled or disabled using a rear-panel switch.

Triggering: external only.

Dimensions: 100 mm x 430 mm x 375 mm (3.9" x 17" x 14.8")

Other: as per the standard AVG-4C-C-N, described at
<http://www.avtechpulse.com/impulse/avg-4c>

Price: \$6836 US each, FOB destination.

Estimated delivery: 60 days after receipt of order.

I have assigned a revised part number (AVG-4B-N-PS-VS2A, with an "A" on the end), because various features (monitor, offset) were added between the issuance of the original quote #8421 and the actual shipment of the AVG-4B-N-PS-VS2 units. Also, the chassis dimensions have changed - we would supply the new unit in a wider chassis than

before. The new chassis is easily rack-mountable, if you order the -R5 rack-mount kit (\$59).

Walter (my father) sends his regards!

Please call or email me if I can be of further assistance.

Regards,
Dr. Michael J. Chudobiak
Chief Engineer

--- Avtech Electrosystems Ltd. ----- since 1975 ---

PO Box 265	ph: 1-800-265-6681 or 613-226-5772	Box 5120,
Ogdensburg,	fax: 1-800-561-1970 or 613-226-2802	LCD Merivale
New York	email: info@avtechpulse.com	Ottawa, Ontario
USA 13669-0265	http://www.avtechpulse.com/	Canada K2C 3H4

Nanosecond Waveform Generators
for general purpose, R&D and OEM applications

Pulse Generators - Laser Diode Drivers - Pulse Amplifiers
Impulse Generators - Current Pulsers - Delay Generators - Splitters
Function Generators - Monocycle Generators - Frequency Dividers + more!

Tom Lynch wrote:

>
> Back in 1998 I purchased two AVG-4B-N-PS-VS2 Pulse Generators that did a -900 Volt Pulse at 3 to 7ns.
> This was your quote #8421.
> My question is, can you build the same instrument or one that has the same characteristics? I have another customer who needs this type of pulser that I can incorporate into a Intensified Digital CCD Camera.
> If you can, I would appreciate it if you could you please quote the price and delivery?
>
> Best Regards,
> Thomas F. Lynch
> VP-Product Manager
> Video Scope International, Ltd.
> 105 Executive Drive, Suite 110
> Dulles, VA 20164-1727
> Phone: 703-437-5534
> Fax: 703-742-8947
> tlynch@videoscopeintl.com <mailto:tlynch@videoscopeintl.com>

SPECIFICATIONS

Model:	AVG-4B-N-PS-VS2A
Amplitude:	> -1000 Volts (to 50 Ohms). Note that coax cable length to load should not exceed 0.5 meter. > -950 Volts to 50 Ohms shunted by 30 pF.
Pulse width, at 20% rise time:	At -900 Volts: 3 to 7 ns. At -100 Volts: 10 to 13 ns.
Rise time:	≤ 2.5 ns
Fall time:	≤ 4 ns
PRF:	0 to 10 kHz
Polarity:	Negative
Propagation delay:	≤ 50 ns (Ext trig in to pulse out)
Jitter:	± 100 ps (Ext trig in to pulse out)
DC offset:	A +50V DC (to Rload > 10 kilohms) internally-generated offset is provided. It may be enabled or disabled using a rear-panel switch.
Triggering:	External trigger only. Trigger required: +5 Volts, 50 to 500 ns (TTL)
Monitor output:	Provides a 20 dB attenuated coincident replica of main output
Dimensions (H x W x D):	100 mm x 430 mm x 375 mm (3.9" x 17" x 14.8")
Power:	100 - 240 Volts, 50 - 60 Hz
Temperature range:	+5°C to +40°C

HIGH-VOLTAGE PRECAUTIONS

 **CAUTION:** This instrument generates output pulse amplitudes as high as 1000 Volts, so extreme caution must be employed when using this instrument. The instrument should only be used by individuals who are thoroughly skilled in high voltage laboratory techniques. The following precautions should always be observed:

1. Keep exposed high-voltage wiring to an absolute minimum.
2. Wherever possible, use shielded connectors and cabling.
3. Connect and disconnect loads and cables only when the amplifier is turned off.
4. Consider using attenuators to reduce observed signals to lower and safer voltages.
5. Keep in mind that all cables, connectors, oscilloscope probes, and loads must have an appropriate voltage rating.

Do not attempt any repairs on the instrument, beyond the fuse replacement procedures described in this manual. Contact Avtech technical support (see page 2 for contact information) if the instrument requires servicing.

EUROPEAN REGULATORY NOTES

EC DECLARATION OF CONFORMITY

We Avtech Electrosystems Ltd.
 P.O. Box 5120, LCD Merivale
 Ottawa, Ontario
 Canada K2C 3H4

declare that this pulse generator meets the intent of Directive 89/336/EEC for Electromagnetic Compatibility. Compliance pertains to the following specifications as listed in the official Journal of the European Communities:

EN 50081-1 Emission

EN 50082-1 Immunity

and that this pulse generator meets the intent of the Low Voltage Directive 72/23/EEC as amended by 93/68/EEC. Compliance pertains to the following specifications as listed in the official Journal of the European Communities:

EN 61010-1:2001 Safety requirements for electrical equipment for measurement, control, and laboratory use



DIRECTIVE 2002/95/EC (RoHS)

This instrument is exempt from Directive 2002/95/EC of the European Parliament and of the Council of 27 January 2003 on the Restriction of the use of certain Hazardous Substances (RoHS) in electrical and electronic equipment. Specifically, Avtech instruments are considered "Monitoring and control instruments" (Category 9) as defined in Annex 1A of Directive 2002/96/EC. The Directive 2002/95/EC only applies to Directive 2002/96/EC categories 1-7 and 10, as stated in the "Article 2 - Scope" section of Directive 2002/95/EC.

DIRECTIVE 2002/96/EC (WEEE)

European customers who have purchased this equipment directly from Avtech will have completed a "WEEE Responsibility Agreement" form, accepting responsibility for WEEE

compliance (as mandated in Directive 2002/96/EC of the European Union and local laws) on behalf of the customer, as provided for under Article 9 of Directive 2002/96/EC.

Customers who have purchased Avtech equipment through local representatives should consult with the representative to determine who has responsibility for WEEE compliance. Normally, such responsibilities will lie with the representative, unless other arrangements (under Article 9) have been made.

Requirements for WEEE compliance may include registration of products with local governments, reporting of recycling activities to local governments, and financing of recycling activities.

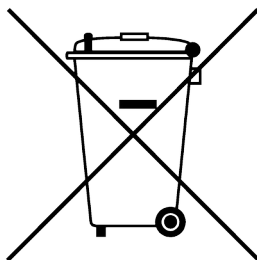

INSTALLATION

VISUAL CHECK

After unpacking the instrument, examine it to ensure that it has not been damaged in shipment. Visually inspect all connectors, knobs, and handles. Confirm that a power cord and an instrumentation manual (this manual), are with the instrument. If the instrument has been damaged, file a claim immediately with the company that transported the instrument.

POWER RATINGS

This instrument is intended to operate from 100 - 240 V, 50 - 60 Hz.

The maximum power consumption is 90 Watts. Please see the “FUSES” section for information about the appropriate AC and DC fuses.

This instrument is an “Installation Category II” instrument, intended for operation from a normal single-phase supply.

CONNECTION TO THE POWER SUPPLY

An IEC-320 three-pronged recessed male socket is provided on the back panel for AC power connection to the instrument. One end of the detachable power cord that is supplied with the instrument plugs into this socket. The other end of the detachable power cord plugs into the local mains supply. Use only the cable supplied with the instrument. The mains supply must be earthed, and the cord used to connect the instrument to the mains supply must provide an earth connection. (The supplied cord does this.)

 Warning: Failure to use a grounded outlet may result in injury or death due to electric shock. This product uses a power cord with a ground connection. It must be connected to a properly grounded outlet. The instrument chassis is connected to the ground wire in the power cord.

The table below describes the power cord that is normally supplied with this instrument, depending on the destination region:

Destination Region	Description	Manufacturer	Part Number
Continental Europe	European CEE 7/7 "Schuko" 230V, 50Hz	Qualtek (http://www.qualtekusa.com)	319004-T01
United Kingdom	BS 1363, 230V, 50Hz	Qualtek (http://www.qualtekusa.com)	370001-E01
Switzerland	SEV 1011, 2 30V, 50Hz	Volex (http://www.volex.com)	2102H-C3-10
Israel	SI 32, 220V, 50Hz	Volex (http://www.volex.com)	2115H-C3-10
North America, and all other areas	NEMA 5-15, 120V, 60 Hz	Qualtek (http://www.qualtekusa.com)	312007-01

PROTECTION FROM ELECTRIC SHOCK

 Operators of this instrument must be protected from electric shock at all times. The owner must ensure that operators are prevented access and/or are insulated from every connection point. In some cases, connections must be exposed to potential human contact. Operators must be trained to protect themselves from the risk of electric shock. This instrument is intended for use by qualified personnel who recognize shock hazards and are familiar with safety precautions required to avoid possibly injury. In particular, operators should:

1. Keep exposed high-voltage wiring to an absolute minimum.
2. Wherever possible, use shielded connectors and cabling.
3. Connect and disconnect loads and cables only when the instrument is turned off.
4. Keep in mind that all cables, connectors, oscilloscope probes, and loads must have an appropriate voltage rating.
5. Do not attempt any repairs on the instrument, beyond the fuse replacement procedures described in this manual. Contact Avtech technical support (see page 2 for contact information) if the instrument requires servicing. Service is to be performed solely by qualified service personnel.

ENVIRONMENTAL CONDITIONS

This instrument is intended for use under the following conditions:

1. indoor use;
2. altitude up to 2 000 m;
3. temperature 5 °C to 40 °C;

4. maximum relative humidity 80 % for temperatures up to 31 °C decreasing linearly to 50 % relative humidity at 40 °C;
5. Mains supply voltage fluctuations up to ± 10 % of the nominal voltage;
6. no pollution or only dry, non-conductive pollution.

FUSES

This instrument contains four fuses. All are accessible from the rear-panel. Two protect the AC prime power input, and two protect the internal DC power supplies. The locations of the fuses on the rear panel are shown in the figure below:

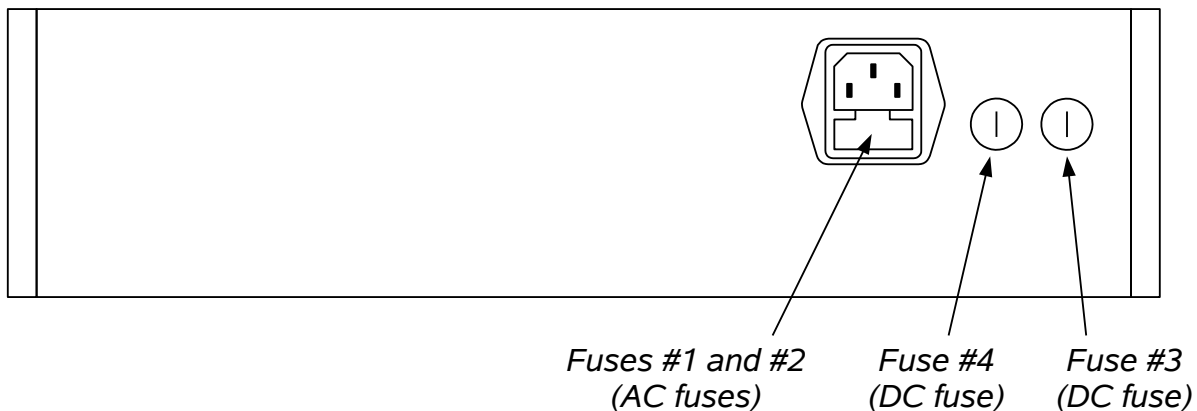

AC FUSE REPLACEMENT

To physically access the AC fuses, the power cord must be detached from the rear panel of the instrument. The fuse drawer may then be extracted using a small flat-head screwdriver, as shown below:

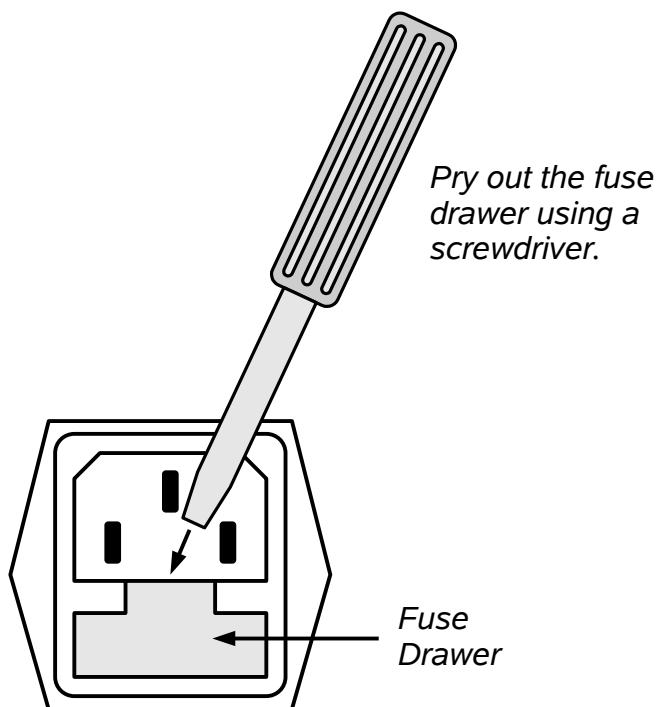

DC FUSE REPLACEMENT

The DC fuses may be replaced by inserting the tip of a flat-head screwdriver into the fuse holder slot, and rotating the slot counter-clockwise. The fuse and its carrier will then pop out.

FUSE RATINGS

The following table lists the required fuses:

Fuses	Nominal Mains Voltage	Rating	Case Size	Recommended Replacement Part	
				Littelfuse Part Number	Digi-Key Stock Number
#1, #2 (AC)	115 V	0.8A, 250V, Time-Delay	5×20 mm	0218.800HXP	F2418-ND
	230 V	0.5A, 250V, Time-Delay	5×20 mm	0218.500HXP	F2416-ND
#3 (DC)	N/A	2.0A, 250V, Time-Delay	5×20 mm	0218002.HXP	F2420-ND
#4 (DC)	N/A	1.0A, 250V, Time-Delay	5×20 mm	0218001.HXP	F2419-ND

The recommended fuse manufacturer is Littelfuse (<http://www.littelfuse.com>).

Replacement fuses may be easily obtained from Digi-Key (<http://www.digikey.com>) and other distributors.

FRONT PANEL CONTROLS

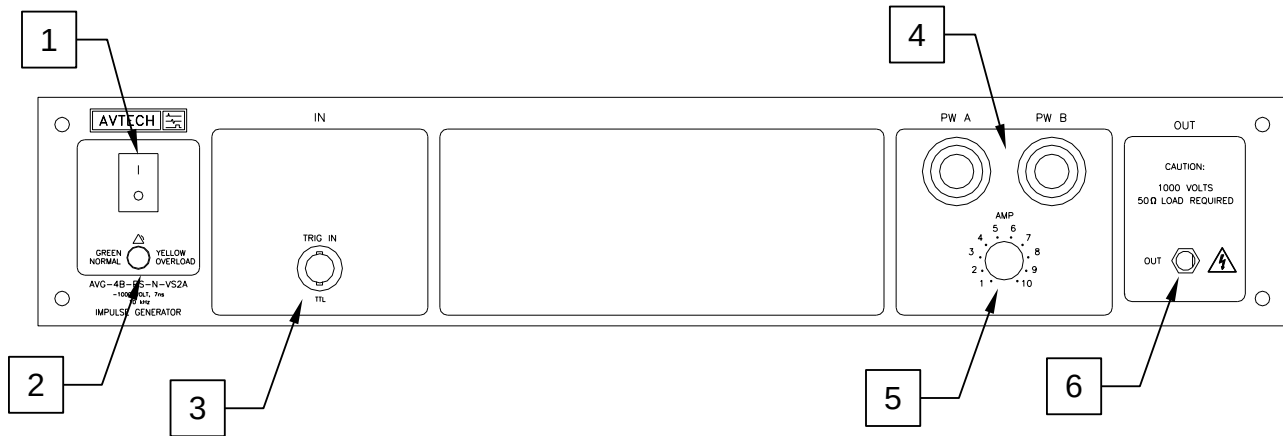

1. POWER Switch. This is the main power switch. When turning the instrument on, there may be a delay of several seconds before the instrument appears to respond.
2. OVERLOAD Indicator. When the instrument is powered, this indicator is normally green, indicating normal operation. If this indicator is yellow, an internal automatic overload protection circuit has been tripped. If the unit is overloaded (by operating at an exceedingly high duty cycle or by operating into a very low impedance), the protective circuit will disable the output of the instrument and turn the indicator light yellow. The light will stay yellow (i.e. output disabled) for about 5 seconds after which the instrument will attempt to re-enable the output (i.e. light green) for about 1 second. If the overload condition persists, the output will be disabled again (i.e. light yellow) for another 5 seconds. If the overload condition has been removed, the instrument will resume normal operation.

This overload indicator may flash yellow briefly at start-up. This is not a cause for concern.

3. TRIG IN Connector. This connector is an input. The external trigger (50 ns or wider, TTL levels) is applied to this connector.

To obtain maximum amplitude and maximum device lifetime, the PRF should be kept as low as possible (preferably < 2 kHz).

4. PULSE SHAPE Controls, and
5. AMPLITUDE Control. The AVG-4B-N-PS-VS2A output stage consists of two separate impulse generator circuits, whose outputs are combined to generate the main output impulse. The PW A and PW B controls vary the pulse widths of the two separate components, allowing you to shape the composite output impulse.

These controls should be set mid-range initially, and adjusted as required.

Rotating PW A clockwise increases the pulse width, without significantly changing the amplitude.

Use the PW B control to “peak” the amplitude as desired.

When rotated counter-clockwise, the AMP control will reduce the amplitude and increase the pulse width. It will also provide a flatter pulse top.

It may be necessary to re-adjust the controls if the pulse repetition frequency (PRF) is changed. The peak amplitude may decrease with increasing PRF.

6. OUT CONNECTOR. This connector provides the main output signal, into load impedances of 50 Ohms.

 Caution: Voltages as high as -1000V may be present on the center conductor of this output connector. Avoid touching this conductor. Connect to this connector using standard coaxial cable, to ensure that the center conductor is not exposed.

REAR PANEL CONTROLS

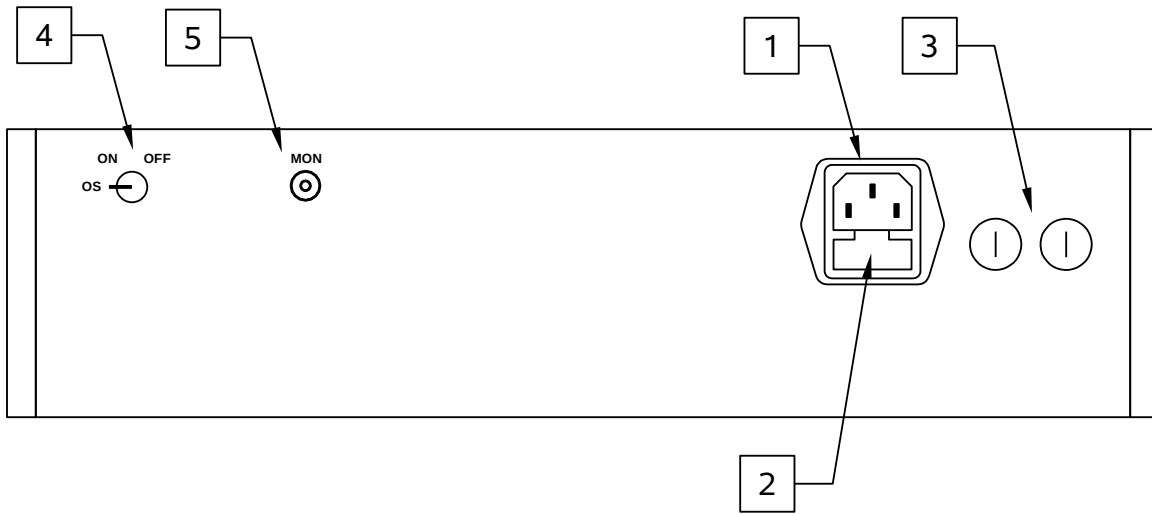



1. AC POWER INPUT. An IEC-320 C14 three-pronged recessed male socket is provided on the back panel for AC power connection to the instrument. One end of the detachable power cord that is supplied with the instrument plugs into this socket.
2. AC FUSE DRAWER. The two fuses that protect the AC input are located in this drawer. Please see the “FUSES” section of this manual for more information.
3. DC FUSES. These two fuses protect the internal DC power supplies. Please see the “FUSES” sections of this manual for more information.
4. OS ON/OFF. This enables / disables the +50V DC offset component of the main output. If the offset is enabled, the DC load impedance must be > 10 kilohms. The AC impedance (seen by the pulse) must always be 50 Ohms. This can be accomplished by adding a DC blocking capacitor in series with a 50 Ohm resistance.
5. M Connector. The monitor output provides an attenuated replica ($\div 11$) of the voltage on the main output. The monitor output is designed to operate into a 50 Ohm load.

GENERAL INFORMATION

BASIC TEST ARRANGEMENT

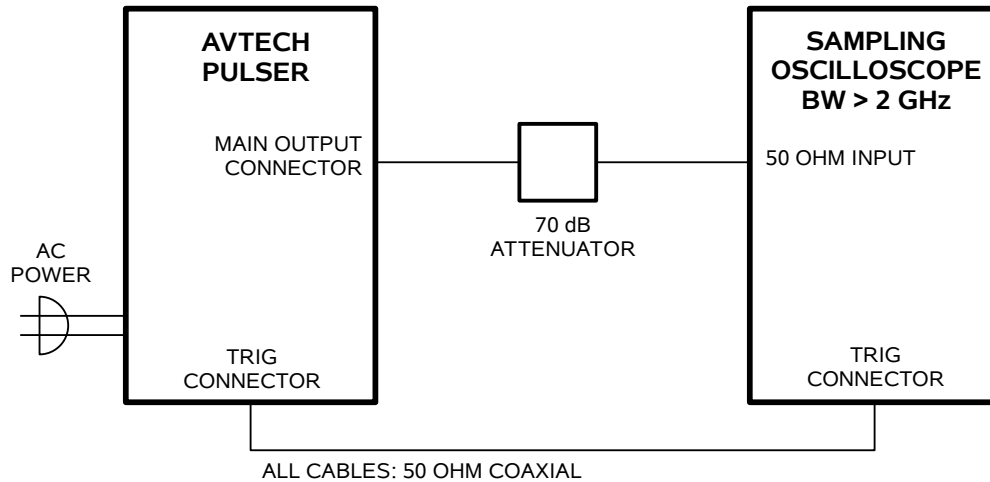
The AVG-4B-N-PS-VS2A should be tested with a sampling oscilloscope with a bandwidth of at least 2 GHz to properly observe the high-speed waveform. A typical test arrangement is shown below:



 The attenuators are required to prevent damage to the sampling oscilloscope. A 80 dB attenuator with an unusually high voltage rating should be used on the main output.

 Do not use the above arrangement if a DC offset is enabled. The DC component requires a high impedance load – this can be achieved by adding a high-voltage DC blocking capacitor in series with the output of the pulser.

BASIC PULSE CONTROL

The instrument is triggered externally. The TRIG connector acts as an input. This is illustrated below:

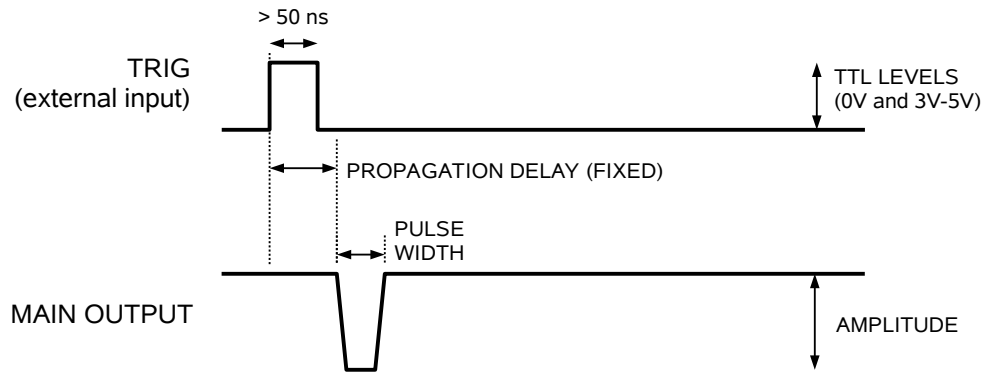

The AVG-4B-N-PS-VS2A output stage consists of two separate impulse generator circuits, whose outputs are combined to generate the main output impulse. The PW A and PW B controls vary the pulse widths of the two separate components, allowing you to shape the composite output impulse.

These controls should be set mid-range initially, and adjusted as required.

Rotating PW A clockwise increases the pulse width, without significantly changing the amplitude.

Use the PW B control to “peak” the amplitude as desired.

When rotated counter-clockwise, the AMP control will reduce the amplitude and increase the pulse width. It will also provide a flatter pulse top.

It may be necessary to re-adjust the controls if the pulse repetition frequency (PRF) is changed. The peak amplitude may decrease with increasing PRF.

To obtain maximum amplitude and maximum device lifetime, the PRF should be kept as low as possible (preferably < 2 kHz).

MECHANICAL INFORMATION

TOP COVER REMOVAL

If necessary, the interior of the instrument may be accessed by removing the four Phillips screws on the top panel. With the four screws removed, the top cover may be slid back (and off).

 Always disconnect the power cord and allow the instrument to sit unpowered for 10 minutes before opening the instrument. This will allow any internal stored charge to discharge.

There are no user-adjustable internal circuits. For repairs other than fuse replacement, please contact Avtech (info@avtechpulse.com) to arrange for the instrument to be returned to the factory for repair. Service is to be performed solely by qualified service personnel.

 Caution: High voltages are present inside the instrument during normal operation. Do not operate the instrument with the cover removed.

RACK MOUNTING

A rack mounting kit is available. The -R5 rack mount kit may be installed after first removing the one Phillips screw on the side panel adjacent to the front handle.

ELECTROMAGNETIC INTERFERENCE

To prevent electromagnetic interference with other equipment, all used outputs should be connected to shielded loads using shielded coaxial cables. Unused outputs should be terminated with shielded coaxial terminators or with shielded coaxial dust caps, to prevent unintentional electromagnetic radiation. All cords and cables should be less than 3m in length.

MAINTENANCE

REGULAR MAINTENANCE

This instrument does not require any regular maintenance.

On occasion, one or more of the four rear-panel fuses may require replacement. All fuses can be accessed from the rear panel. See the “FUSES” section for details.

CLEANING

If desired, the interior of the instrument may be cleaned using compressed air to dislodge any accumulated dust. (See the “TOP COVER REMOVAL” section for instructions on accessing the interior.) No other cleaning is recommended.

WIRING DIAGRAMS

WIRING OF AC POWER

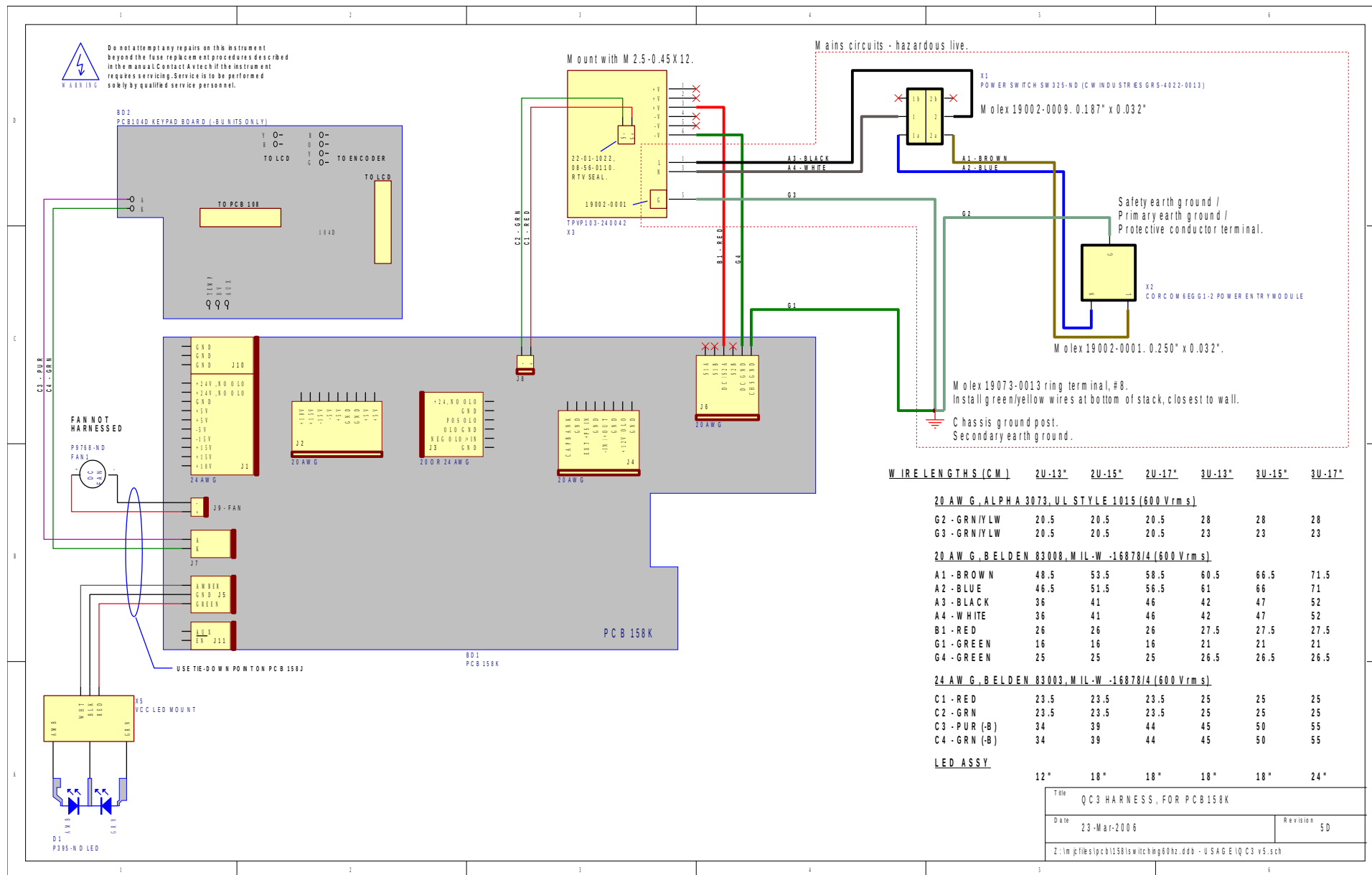

PCB 158K - LOW VOLTAGE POWER SUPPLY, 1/3

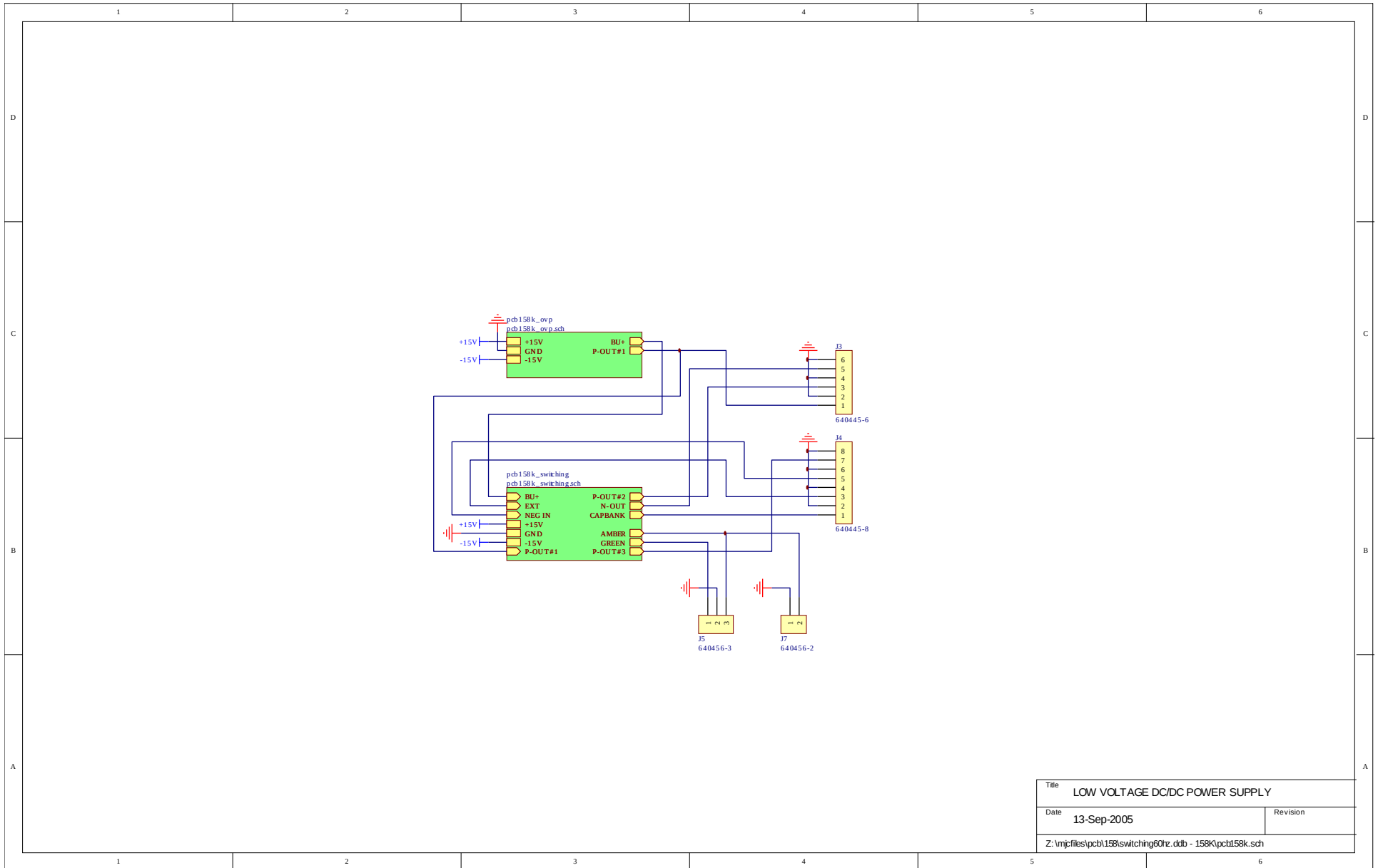

Title	LOW VOLTAGE DC/DC POWER SUPPLY	
Date	13-Sep-2005	Revision
Z:\mpjfiles\pcb158\swiching01rz.ddb - 158K\pcb158k.sch		

PCB 158K - LOW VOLTAGE POWER SUPPLY, 2/3

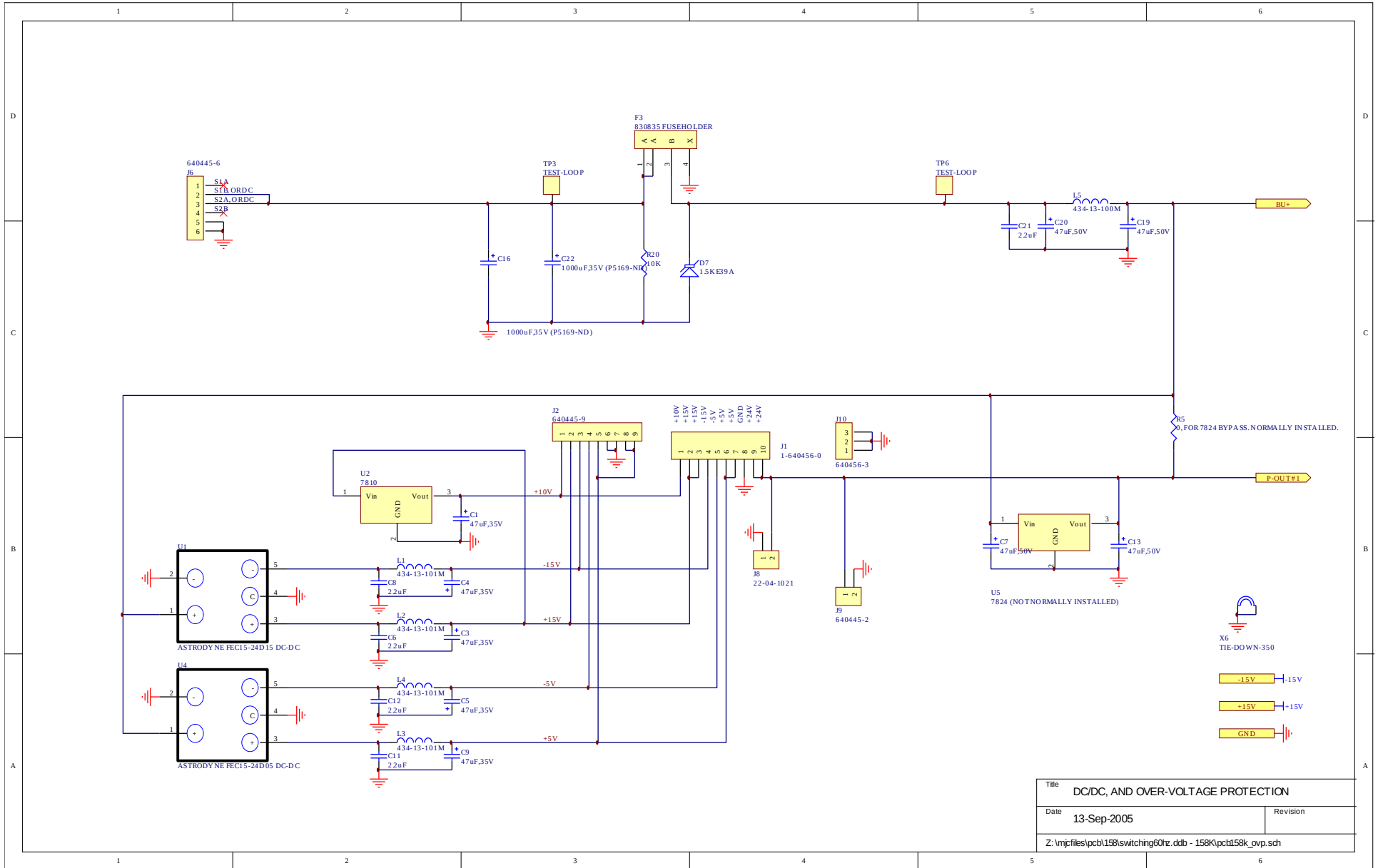

PCB 158K - LOW VOLTAGE POWER SUPPLY, 3/3

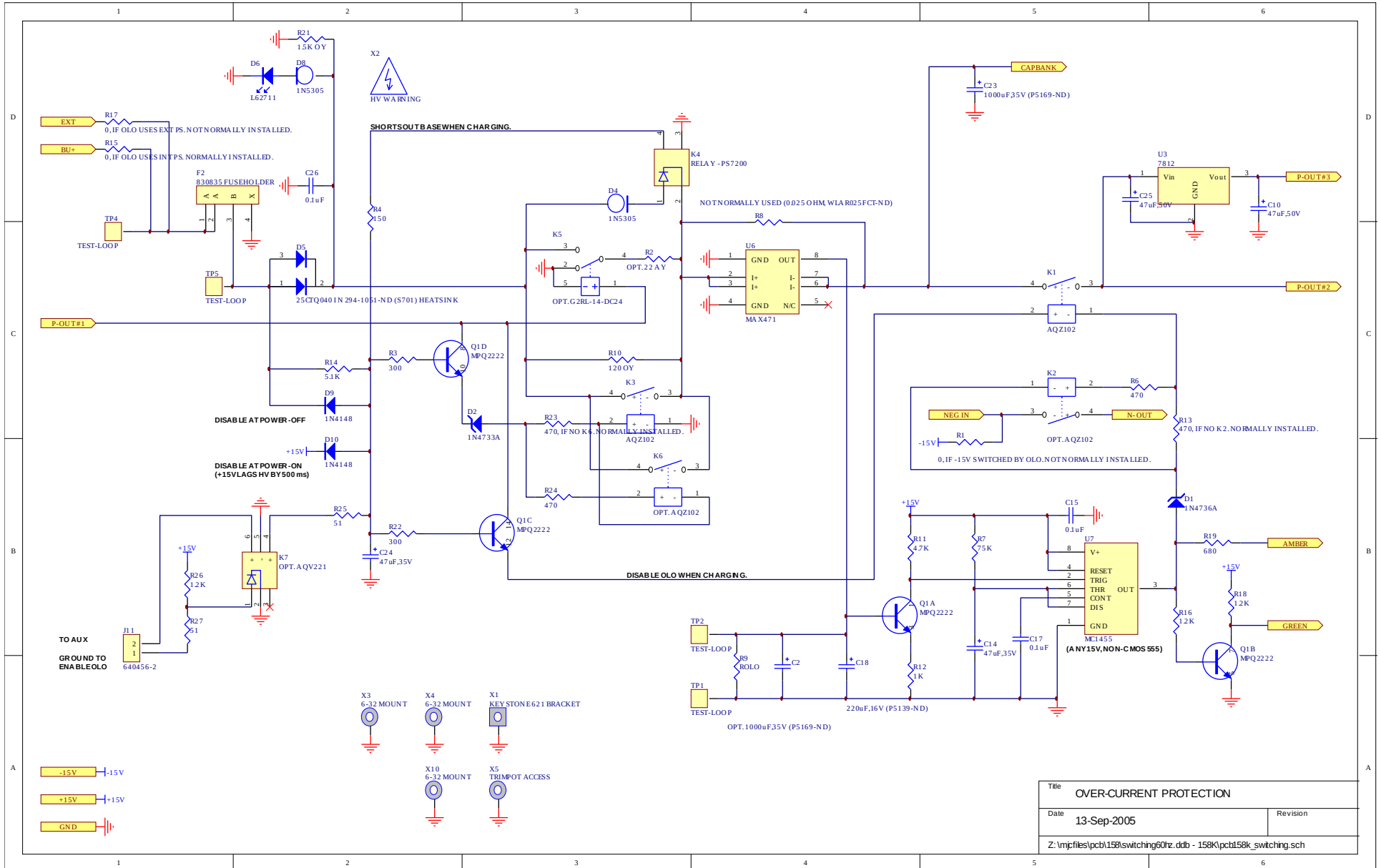

PCB 168B - HIGH VOLTAGE DC POWER SUPPLY

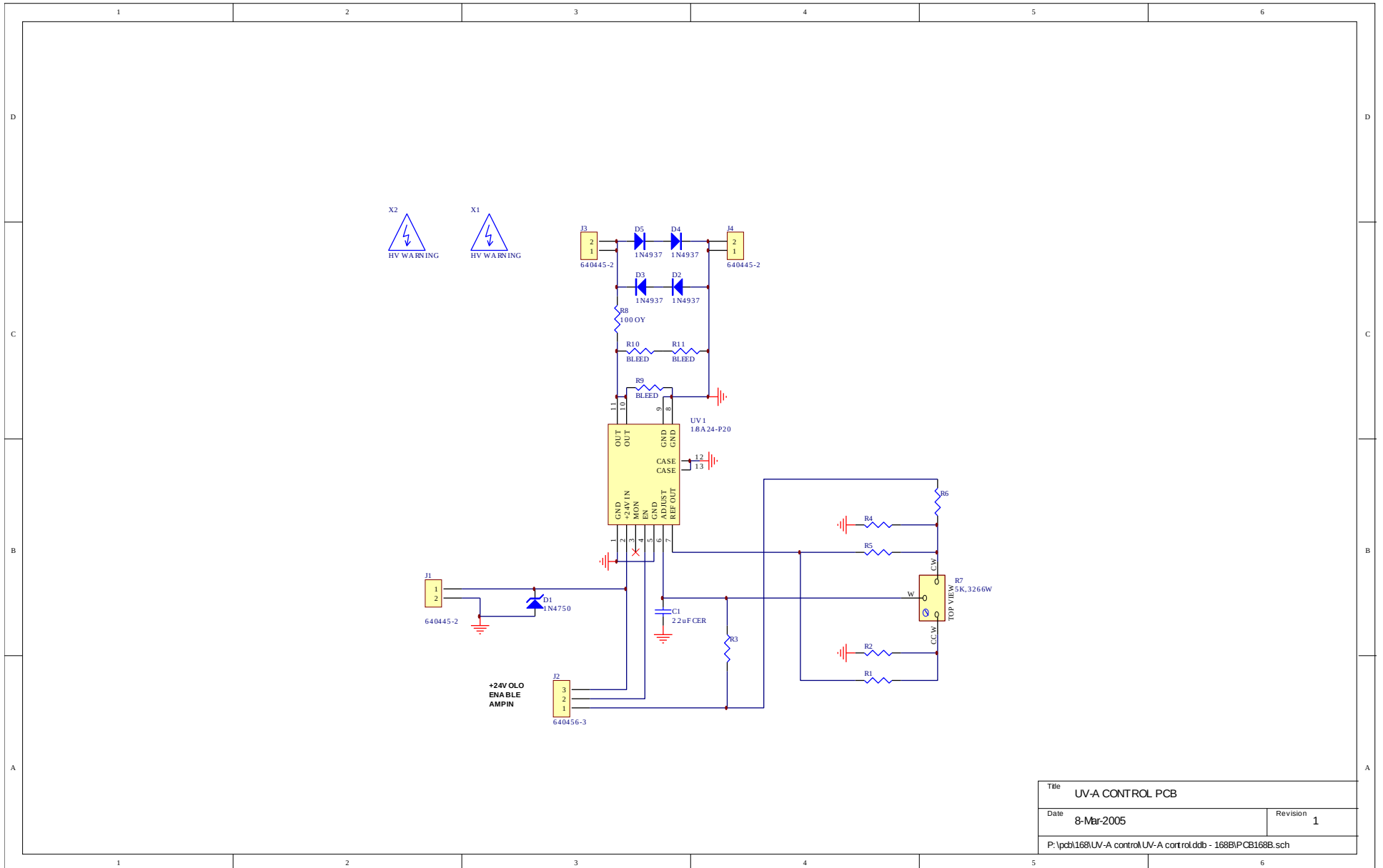

Title UV-A CONTROL PCB	
Date 8-Mar-2005	Revision 1
P:\pcb\168\UV-A control\UV-A control.dtb - 168B\PCB168B.sch	

MAIN WIRING

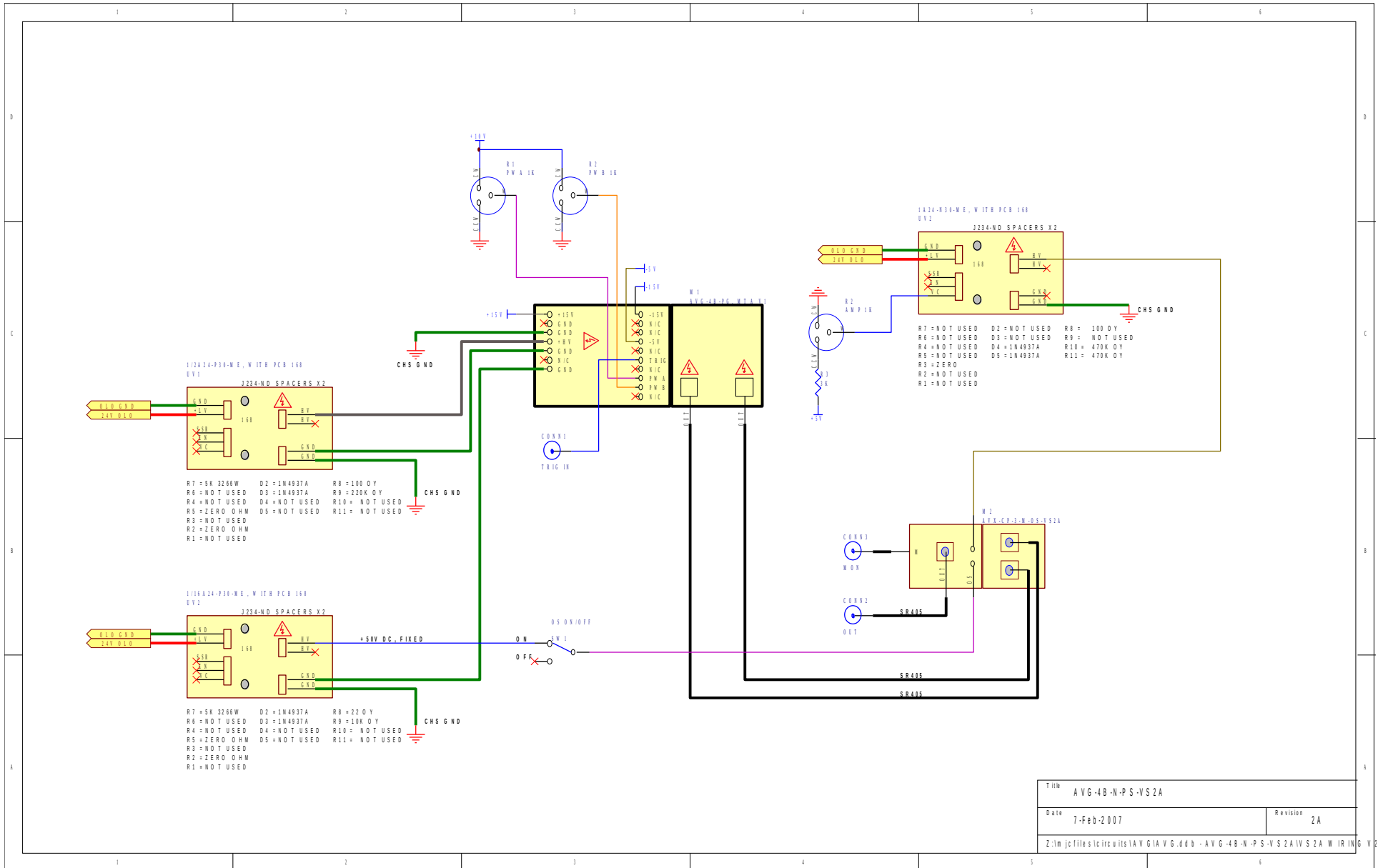

Title		AVG-4B-N-PS-VS2A
Date	7-Feb-2007	Revision 2A
Z:\lm\jc\files\lc\irc\wits\AVG\AVG.dbb - AVG-4B-N-PS-VS2A\VS2A.WIRING.V		

PERFORMANCE CHECK SHEET