



AVTECH ELECTROSYSTEMS LTD.

NANOSECOND WAVEFORM ELECTRONICS  
SINCE 1975

P.O. BOX 265  
OGDENSBURG, NY  
U.S.A. 13669-0265

TEL: 888-670-8729 (USA & Canada) or +1-613-686-6675 (Intl)  
FAX: 800-561-1970 (USA & Canada) or +1-613-686-6679 (Intl)

info@avtechpulse.com - <http://www.avtechpulse.com/>

BOX 5120, LCD MERIVALE  
OTTAWA, ONTARIO  
CANADA K2C 3H4

## INSTRUCTIONS

MODEL AVH-S-1-C  
0 TO 10 VOLTS, 1 MHz  
IMPULSE GENERATOR  
WITH 130 ps PULSE WIDTH

SERIAL NUMBER: \_\_\_\_\_

### WARRANTY

Avtech Electrosystems Ltd. warrants products of its manufacture to be free from defects in material and workmanship under conditions of normal use. If, within one year after delivery to the original owner, and after prepaid return by the original owner, this Avtech product is found to be defective, Avtech shall at its option repair or replace said defective item. This warranty does not apply to units which have been disassembled, modified or subjected to conditions exceeding the applicable specifications or ratings. This warranty is the extent of the obligation assumed by Avtech with respect to this product and no other warranty or guarantee is either expressed or implied.

### TECHNICAL SUPPORT

Phone: 888-670-8729 (USA & Canada) or +1-613-686-6675 (International)

Fax: 800-561-1970 (USA & Canada) or +1-613-686-6679 (International)

E-mail: [info@avtechpulse.com](mailto:info@avtechpulse.com)

World Wide Web: <http://www.avtechpulse.com>

## TABLE OF CONTENTS

<b>WARRANTY.....</b>	<b>2</b>
<b>TECHNICAL SUPPORT.....</b>	<b>2</b>
<b>TABLE OF CONTENTS.....</b>	<b>3</b>
<b>INTRODUCTION.....</b>	<b>5</b>
<b>AVAILABLE OPTIONS.....</b>	<b>5</b>
<b>SPECIFICATIONS.....</b>	<b>6</b>
<b>EUROPEAN REGULATORY NOTES.....</b>	<b>7</b>
<b>EC DECLARATION OF CONFORMITY.....</b>	<b>7</b>
<b>DIRECTIVE 2002/95/EC (RoHS).....</b>	<b>7</b>
<b>DIRECTIVE 2002/96/EC (WEEE).....</b>	<b>7</b>
<b>INSTALLATION.....</b>	<b>9</b>
<b>VISUAL CHECK.....</b>	<b>9</b>
<b>POWER RATINGS.....</b>	<b>9</b>
<b>CONNECTION TO THE POWER SUPPLY.....</b>	<b>9</b>
<b>PROTECTION FROM ELECTRIC SHOCK.....</b>	<b>10</b>
<b>ENVIRONMENTAL CONDITIONS.....</b>	<b>10</b>
<b>FUSES.....</b>	<b>12</b>
<b>AC FUSE REPLACEMENT.....</b>	<b>12</b>
<b>DC FUSE REPLACEMENT.....</b>	<b>13</b>
<b>FUSE RATINGS.....</b>	<b>13</b>
<b>FRONT PANEL CONTROLS.....</b>	<b>14</b>
<b>REAR PANEL CONTROLS.....</b>	<b>16</b>
<b>GENERAL INFORMATION.....</b>	<b>17</b>
<b>BASIC TEST ARRANGEMENT.....</b>	<b>17</b>
<b>BASIC PULSE CONTROL.....</b>	<b>17</b>
<b>AMPLITUDE INTERACTION.....</b>	<b>18</b>
<b>OPERATION AT LOW AMPLITUDES.....</b>	<b>18</b>
<b>OSCILLOSCOPE SELECTION AND BANDWIDTH ISSUES.....</b>	<b>18</b>
<b>MINIMIZING WAVEFORM DISTORTIONS.....</b>	<b>20</b>
<b>USE 50Ω TRANSMISSION LINES AND LOADS.....</b>	<b>20</b>
<b>USE LOW-INDUCTANCE LOADS.....</b>	<b>20</b>
<b>PREVENTING DAMAGE.....</b>	<b>20</b>
<b>MECHANICAL INFORMATION.....</b>	<b>21</b>

TOP COVER REMOVAL.....	21
RACK MOUNTING.....	21
ELECTROMAGNETIC INTERFERENCE.....	21
<b>MAINTENANCE.....</b>	<b>22</b>
REGULAR MAINTENANCE.....	22
CLEANING.....	22
<b>WIRING DIAGRAMS.....</b>	<b>23</b>
WIRING OF AC POWER.....	23
PCB 158N - LOW VOLTAGE POWER SUPPLY, 1/3.....	24
PCB 158N - LOW VOLTAGE POWER SUPPLY, 2/3.....	25
PCB 158N - LOW VOLTAGE POWER SUPPLY, 3/3.....	26
PCB 168B - HIGH VOLTAGE DC POWER SUPPLY.....	27
PCB 126C - OSCILLATOR AND TRIGGER CIRCUIT.....	28
MAIN WIRING - POSITIVE UNITS.....	29
MAIN WIRING – DUAL-POLARITY (-PN) UNITS.....	30
<b>PERFORMANCE CHECK SHEET.....</b>	<b>31</b>

Manual Reference: /files/server1/officefiles/instructword/avh/AVH-S-1-C, edition j.odt.

Last modified February 29, 2024.

Copyright © 2024 Avtech Electrosystems Ltd, All Rights Reserved.

## INTRODUCTION

The AVH-S-1-C is a high performance instrument capable of generating up to 10 Volts into 50Ω loads at repetition rates up to 1 MHz. The output pulse width is 130 ps or less, measured at the 20% rise time point (the FWHM pulse width is less).

Instruments with the "-P" model suffix can generate 0 to +10V, whereas instruments with the "-N" model suffix can generate 0 to -10V. Instruments with the "-PN" suffix can generate both polarities.

The output is designed to drive 50Ω loads. (A 50Ω load is required for proper operation.) The output is AC-coupled.

This instrument is intended for use in research, development, test and calibration laboratories by qualified personnel.

## AVAILABLE OPTIONS

The AVH-S-1-C is available with the following option:

-AK1 Option: Recommended accessory kit. Consists of three SMA, 18 GHz, 2 Watt attenuators (10, 20 & 30 dB) for use on the output, and two 50 Ohm, 1 GHz, 1 Watt feed-through terminators (one SMA, one BNC) for use on external trigger inputs.

-OS Option: an externally generated DC offset can be added to the output.

## SPECIFICATIONS

Model:	AVH-S-1-C <sup>1</sup>
Amplitude <sup>3,9</sup> : (50Ω load)	0 to 10 V
Pulse width (20% rise time):	≤ 130 ps
PRF:	0 to 1 MHz
Polarity <sup>5</sup> :	Positive, negative, or dual-polarity (specify)
Propagation delay:	≤ 200 ns (Ext trig in to pulse out)
Required load impedance:	50 Ohms <sup>10</sup>
Jitter:	± 15 ps (Ext trig in to pulse out)
Two channel option:	Optional <sup>8</sup> .
Double pulse option:	Optional <sup>9</sup> .
DC offset option <sup>6</sup> :	Apply required DC offset to back-panel solder terminals (± 50 Volts, 250 mA max)
Trigger required:	Ext trig mode: + 5 Volts, 50 to 500 ns (TTL)
Sync delay:	Sync out to pulse out: Variable 0 to 200 ns
Sync output:	+3 Volts, 200 ns, will drive 50 Ohm loads
Connectors:	Out: SMA, Trig/Sync: BNC
Power requirements:	100 - 240 Volts, 50 - 60 Hz
Dimensions (H x W x D):	100 mm x 430 mm x 375 mm (3.9" x 17" x 14.8")
Optional rack-mount kit:	Add the suffix "-R5" to the model number to include 19" rack mount kit.
Operating temperature:	+5°C to +40°C

- 1) -C suffix indicates stand-alone lab instrument with internal clock and line powering. No suffix indicates miniature module requiring DC power and external trigger. (See <http://www.avtechpulse.com/formats> for the basic instrument formats).
- 2) -B suffix indicates IEEE-488.2 GPIB and RS-232 control of amplitude, PRF, delay and polarity. (See <http://www.avtechpulse.com/gpib>).
- 3) For operation of variable-amplitude units at amplitudes of less than 20% of full-scale, best results will be obtained by setting the amplitude near full-scale and using external attenuators on the output.
- 4) For 800 ps pulse width option, add suffix -T1.
- 5) Indicate desired polarity by suffixing model number with -P or -N (i.e. positive or negative) or -PN for dual polarity option. Polarity reversal achieved by means of a two-position switch that controls the polarity of the signal output port on -C units and via keypad control on -B units. -PN option not available on modules.
- 6) For DC offset option suffix the model number with -OS. Avtech Model AVX-T bias tee can also be used to obtain DC offset. -B suffix indicates IEEE-488.2 GPIB and RS-232 control of amplitude and frequency. See <http://www.avtechpulse.com/gpib> for details.
- 7) Add the suffix -TNT to the model number to specify the Telnet / Ethernet control option.
- 8) For the two channel option, add the suffix -2CHPP for two positive outputs, the suffix -2CHNN for two negative outputs, or the suffix -2CHPN for the one positive output and one negative output.
- 9) For the double pulse option add the suffix -DPP for a unipolar output, and add the suffix -DPN for a bipolar output. Note that the maximum amplitude is reduced to 70% for DP option units.
- 10) A 50 Ohm load is required. Other loads may damage the instrument. Consult Avtech ([info@avtechpulse.com](mailto:info@avtechpulse.com)) if you need to drive other load impedances.

## EUROPEAN REGULATORY NOTES

### EC DECLARATION OF CONFORMITY

We Avtech Electrosystems Ltd.  
P.O. Box 5120, LCD Merivale  
Ottawa, Ontario  
Canada K2C 3H4

declare that this pulse generator meets the intent of Directive 89/336/EEC for Electromagnetic Compatibility. Compliance pertains to the following specifications as listed in the official Journal of the European Communities:

EN 50081-1 Emission

EN 50082-1 Immunity

and that this pulse generator meets the intent of the Low Voltage Directive 72/23/EEC as amended by 93/68/EEC. Compliance pertains to the following specifications as listed in the official Journal of the European Communities:

EN 61010-1:2001 Safety requirements for electrical equipment for measurement, control, and laboratory use



### DIRECTIVE 2002/95/EC (RoHS)

This instrument is exempt from Directive 2002/95/EC of the European Parliament and of the Council of 27 January 2003 on the Restriction of the use of certain Hazardous Substances (RoHS) in electrical and electronic equipment. Specifically, Avtech instruments are considered "Monitoring and control instruments" (Category 9) as defined in Annex 1A of Directive 2002/96/EC. The Directive 2002/95/EC only applies to Directive 2002/96/EC categories 1-7 and 10, as stated in the "Article 2 - Scope" section of Directive 2002/95/EC.

### DIRECTIVE 2002/96/EC (WEEE)

European customers who have purchased this equipment directly from Avtech will have completed a "WEEE Responsibility Agreement" form, accepting responsibility for WEEE

compliance (as mandated in Directive 2002/96/EC of the European Union and local laws) on behalf of the customer, as provided for under Article 9 of Directive 2002/96/EC.

Customers who have purchased Avtech equipment through local representatives should consult with the representative to determine who has responsibility for WEEE compliance. Normally, such responsibilities will lie with the representative, unless other arrangements (under Article 9) have been made.

Requirements for WEEE compliance may include registration of products with local governments, reporting of recycling activities to local governments, and financing of recycling activities.





## INSTALLATION

### VISUAL CHECK

After unpacking the instrument mainframe and the transformer module, examine to ensure that they have not been damaged in shipment. Visually inspect all connectors, knobs, and handles. Confirm that a power cord and an instrumentation manual (this manual), are with the instrument. If the instrument has been damaged, file a claim immediately with the company that transported the instrument.

### POWER RATINGS

This instrument is intended to operate from 100 - 240 V, 50 - 60 Hz.

The maximum power consumption is 57 Watts. Please see the “FUSES” section for information about the appropriate AC and DC fuses.

This instrument is an “Installation Category II” instrument, intended for operation from a normal single-phase supply.

### CONNECTION TO THE POWER SUPPLY

An IEC-320 three-pronged recessed male socket is provided on the back panel for AC power connection to the instrument. One end of the detachable power cord that is supplied with the instrument plugs into this socket. The other end of the detachable power cord plugs into the local mains supply. Use only the cable supplied with the instrument. The mains supply must be earthed, and the cord used to connect the instrument to the mains supply must provide an earth connection. (The supplied cord does this.)

 Warning: Failure to use a grounded outlet may result in injury or death due to electric shock. This product uses a power cord with a ground connection. It must be connected to a properly grounded outlet. The instrument chassis is connected to the ground wire in the power cord.

The table below describes the power cord that is normally supplied with this instrument, depending on the destination region:

Destination Region	Description	Manufacturer	Part Number
Continental Europe	European CEE 7/7 "Schuko" 230V, 50Hz	Qualtek ( <a href="http://www.qualtekusa.com">http://www.qualtekusa.com</a> )	319004-T01
United Kingdom	BS 1363, 230V, 50Hz	Qualtek ( <a href="http://www.qualtekusa.com">http://www.qualtekusa.com</a> )	370001-E01
Switzerland	SEV 1011, 2 30V, 50Hz	Volex ( <a href="http://www.volex.com">http://www.volex.com</a> )	2102H-C3-10
Israel	SI 32, 220V, 50Hz	Volex ( <a href="http://www.volex.com">http://www.volex.com</a> )	2115H-C3-10
North America, and all other areas	NEMA 5-15, 120V, 60 Hz	Qualtek ( <a href="http://www.qualtekusa.com">http://www.qualtekusa.com</a> )	312007-01

### PROTECTION FROM ELECTRIC SHOCK

 Operators of this instrument must be protected from electric shock at all times. The owner must ensure that operators are prevented access and/or are insulated from every connection point. In some cases, connections must be exposed to potential human contact. Operators must be trained to protect themselves from the risk of electric shock. This instrument is intended for use by qualified personnel who recognize shock hazards and are familiar with safety precautions required to avoid possibly injury. In particular, operators should:

1. Keep exposed high-voltage wiring to an absolute minimum.
2. Wherever possible, use shielded connectors and cabling.
3. Connect and disconnect loads and cables only when the instrument is turned off.
4. Keep in mind that all cables, connectors, oscilloscope probes, and loads must have an appropriate voltage rating.
5. Do not attempt any repairs on the instrument, beyond the fuse replacement procedures described in this manual. Contact Avtech technical support (see page 2 for contact information) if the instrument requires servicing. Service is to be performed solely by qualified service personnel.

### ENVIRONMENTAL CONDITIONS

This instrument is intended for use under the following conditions:

1. indoor use;
2. altitude up to 2 000 m;
3. temperature 5 °C to 40 °C;

4. maximum relative humidity 80 % for temperatures up to 31 °C decreasing linearly to 50 % relative humidity at 40 °C;
5. Mains supply voltage fluctuations up to  $\pm 10$  % of the nominal voltage;
6. no pollution or only dry, non-conductive pollution.

## FUSES

This instrument contains four fuses. All are accessible from the rear-panel. Two protect the AC prime power input, and two protect the internal DC power supplies. The locations of the fuses on the rear panel are shown in the figure below:

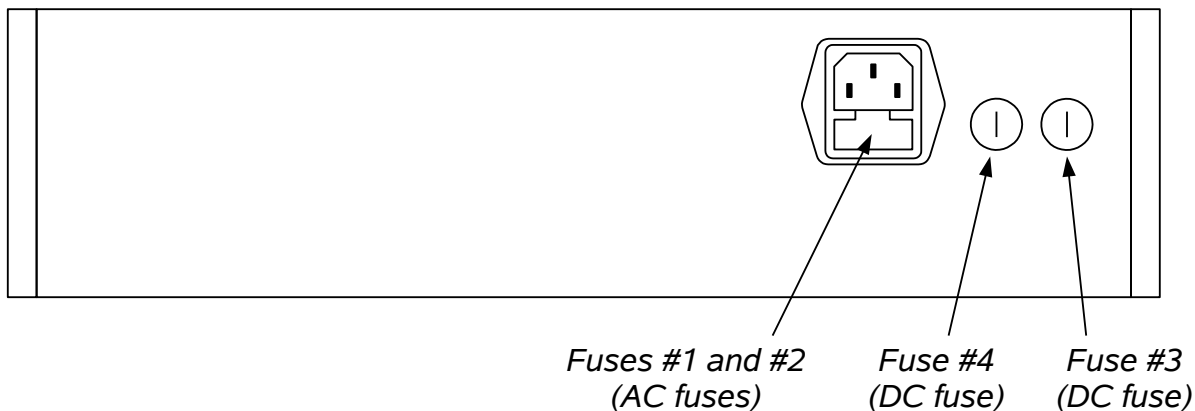

### AC FUSE REPLACEMENT

To physically access the AC fuses, the power cord must be detached from the rear panel of the instrument. The fuse drawer may then be extracted using a small flat-head screwdriver, as shown below:

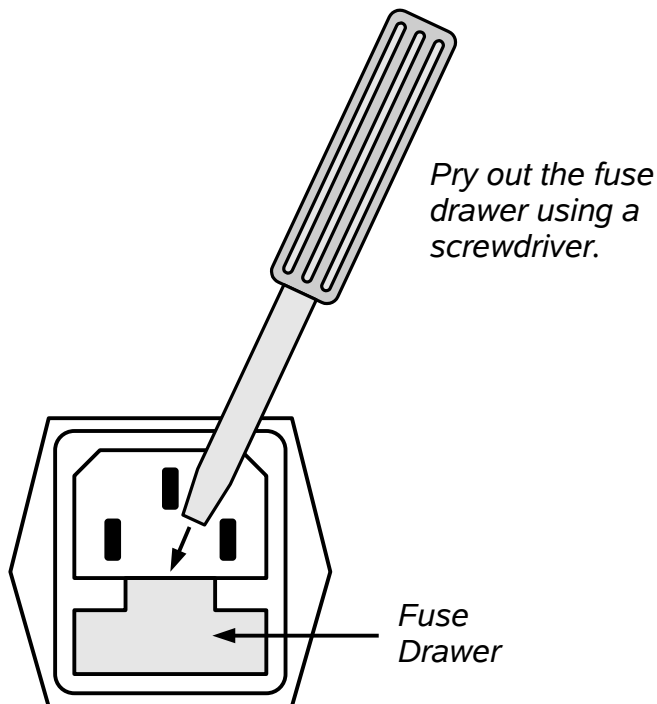

## DC FUSE REPLACEMENT

The DC fuses may be replaced by inserting the tip of a flat-head screwdriver into the fuse holder slot, and rotating the slot counter-clockwise. The fuse and its carrier will then pop out.

## FUSE RATINGS

The following table lists the required fuses:

Fuses	Nominal Mains Voltage	Rating	Case Size	Recommended Replacement Part	
				Littelfuse Part Number	Digi-Key Stock Number
#1, #2 (AC)	100-240V	0.5A, 250V, Time-Delay	5×20 mm	0218.500HXP	F2416-ND
#3 (DC)	N/A	0.5A, 250V, Time-Delay	5×20 mm	0218.500HXP	F2416-ND
#4 (DC)	N/A	0.25A, 250V, Time-Delay	5×20 mm	0218.250HXP	F2413-ND

The recommended fuse manufacturer is Littelfuse (<http://www.littelfuse.com>).

Replacement fuses may be easily obtained from Digi-Key (<http://www.digikey.com>) and other distributors.

## FRONT PANEL CONTROLS

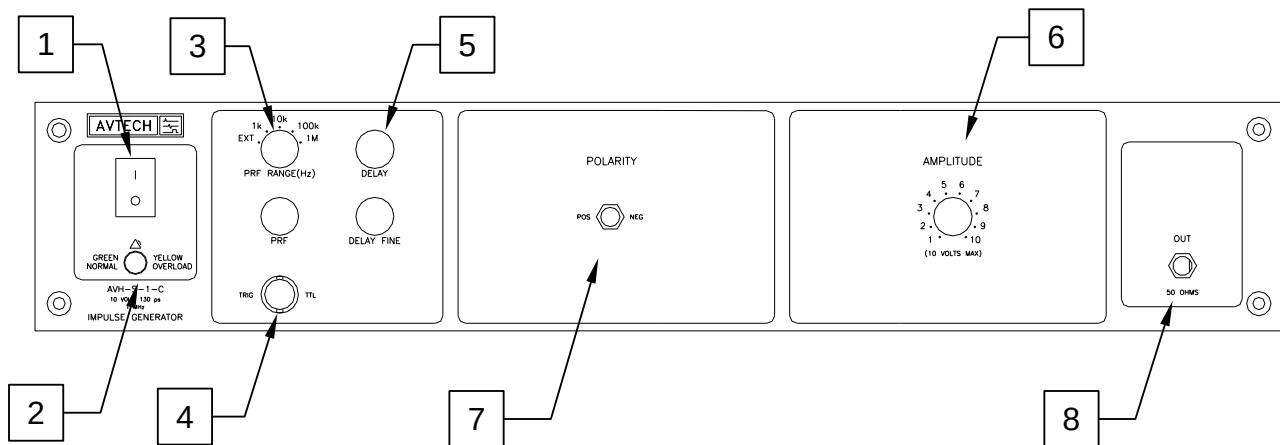

- 1) POWER Switch. This is the main power switch. When turning the instrument on, there may be a delay of several seconds before the instrument appears to respond.
- 2) OVERLOAD Indicator. When the instrument is powered, this indicator is normally green, indicating normal operation. If this indicator is yellow, an internal automatic overload protection circuit has been tripped. If the unit is overloaded (by operating at an exceedingly high duty cycle or by operating into a very low impedance), the protective circuit will disable the output of the instrument and turn the indicator light yellow. The light will stay yellow (i.e. output disabled) for about 5 seconds after which the instrument will attempt to re-enable the output (i.e. light green) for about 1 second. If the overload condition persists, the output will be disabled again (i.e. light yellow) for another 5 seconds. If the overload condition has been removed, the instrument will resume normal operation.

This overload indicator may flash yellow briefly at start-up. This is not a cause for concern.

- 3) PRF Range Switch. This switch sets the pulse repetition frequency (PRF) range of the internal oscillator. The marked value of each position is the upper limit of the 10:1 range, approximately. The vernier dial directly below the switch varies the PRF within the set range.

If this switch is set to the "EXT" position, the instrument is triggered by a signal applied to the TRIG connector, rather than by the internal oscillator.

- 4) TRIG Connector. When the PRF Range Switch is set to "EXT", the instrument is triggered by a TTL pulse applied to this connector. The pulse must be at least 50 ns wide.

When the PRF Range Switch is set to one of the four internal oscillator ranges, this connector is an output, which supplies a 2V, 200 ns wide pulse for each trigger

event. This output may be used to trigger oscilloscopes or other equipment.

- 5) Delay Controls. When the PRF Range Switch is set to one of the four internal oscillator ranges, the main output is advanced or delayed relative to the TRIG output pulse (item 3). The delay is variable up to 200 ns, approximately, using the DELAY and DELAY FINE dials.
- 6) Amplitude Control. This dial controls the amplitude.
- 7) Polarity Switch. (Present on -PN units only.) This switch controls the output polarity (positive or negative).
- 8) OUT Connector. This SMA connector provides the main output. This output *requires* a 50 $\Omega$  load to function properly.

## REAR PANEL CONTROLS

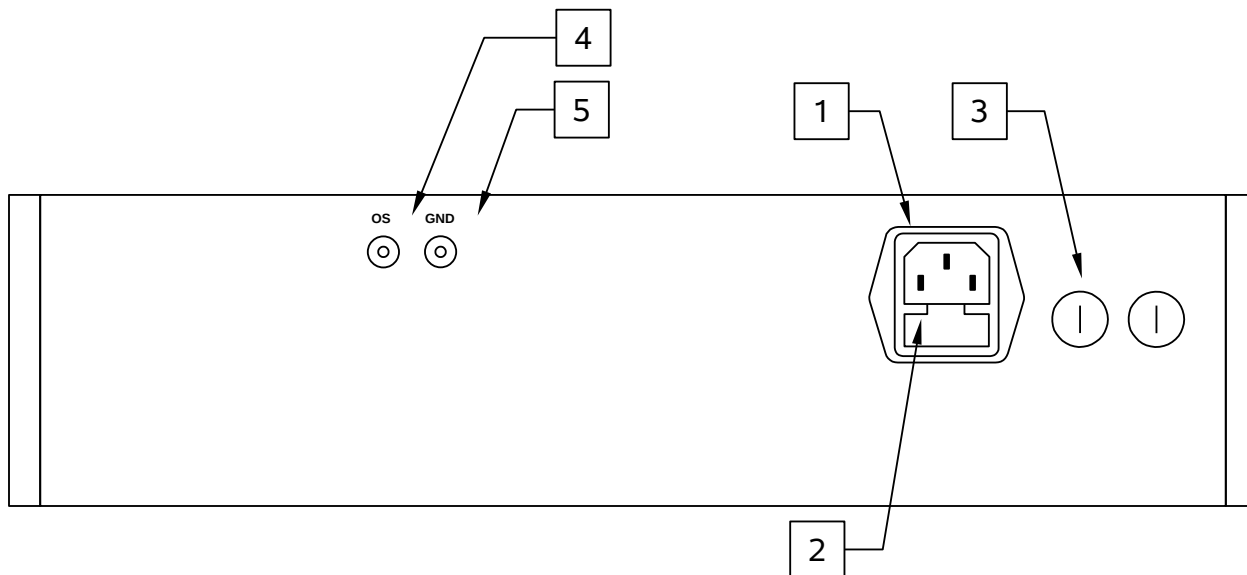

1. AC POWER INPUT. An IEC-320 C14 three-pronged recessed male socket is provided on the back panel for AC power connection to the instrument. One end of the detachable power cord that is supplied with the instrument plugs into this socket.
2. AC FUSE DRAWER. The two fuses that protect the AC input are located in this drawer. Please see the “FUSES” section of this manual for more information.
3. DC FUSES. These two fuses protect the internal DC power supplies. Please see the “FUSES” sections of this manual for more information.
4. OS INPUT CONNECTOR. (Present on units with -OS option only.) A DC offset in the range of  $\pm 50\text{V}$  (250 mA max) may be applied to this solder terminal. The DC offset will appear on the output. When this feature is not used, the OS input should be connected to ground (using the adjacent GND connector). This is especially important when driving loads containing a diode.
5. GND CONNECTOR. (Present on units with -OS option only.) This solder terminal is connected to ground. It may be used to ground the OS input connector.



## GENERAL INFORMATION

### BASIC TEST ARRANGEMENT

The AVH-S-1-C should be tested with a sampling oscilloscope with a bandwidth of at least 15 GHz to properly observe the high-speed waveform. A typical test arrangement is shown below:

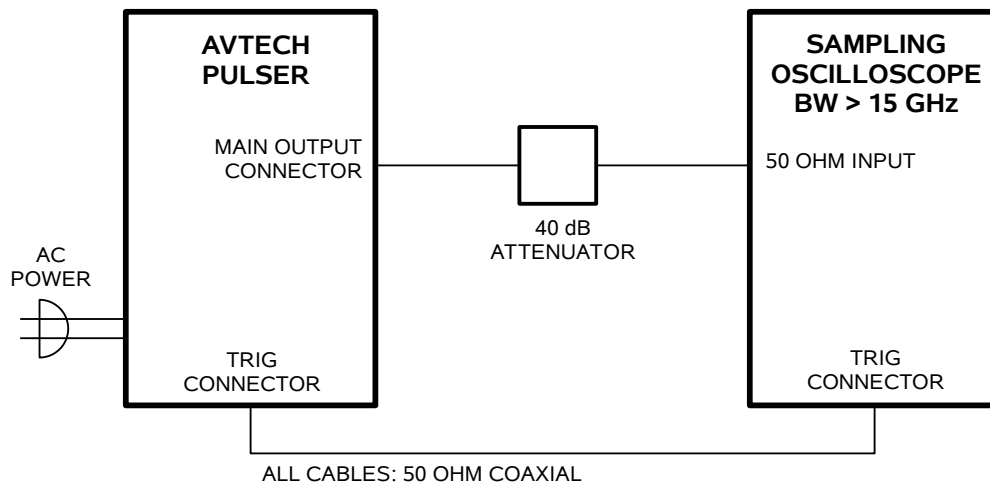

The attenuators are required to prevent damage to the sampling oscilloscope. A 40 dB attenuator with sufficient bandwidth should be used on the main output. Avtech recommends the ATT-0444-XX-SMA-02 series of 18 GHz coaxial attenuators from Midwest Microwave, <http://www.midwestmicrowave.com>. (The “XX” in the part number is replaced with the numeric attenuation value in dB).

### BASIC PULSE CONTROL

This instrument can be triggered by its own internal clock or by an external TTL trigger signal. When triggered internally, two mainframe output channels respond to the trigger: OUT and SYNC.

- OUT. This is the main output.
- SYNC. The SYNC pulse is a 3V, 200 ns reference pulse used to trigger oscilloscopes or other measurement systems.

These pulses are illustrated below:

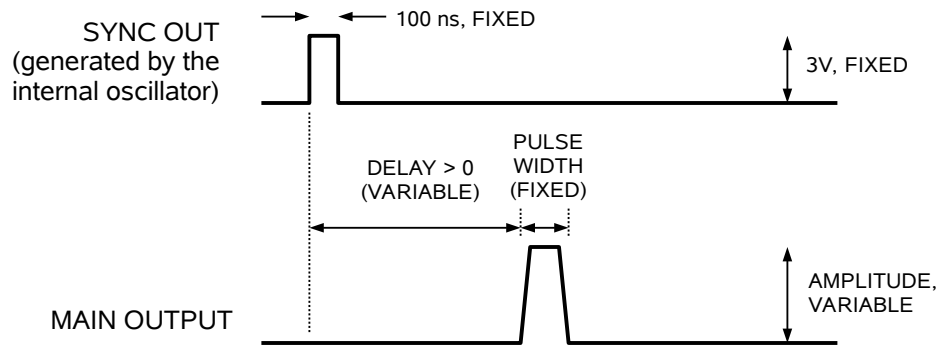

Figure A

The AVH-S-1-C can also be triggered by a TTL-level pulse applied to the TRIG input.

### AMPLITUDE INTERACTION

Some properties of the output pulse may change as a function of the amplitude setting. For some demanding applications, it may be desirable to use a combination of external attenuators and the amplitude pot to achieve the desired output amplitude.

### OPERATION AT LOW AMPLITUDES

This instrument will generate the best waveforms when operated near maximum amplitude. If amplitudes less than 1/3 of the full-scale value are desired, better results will be obtained if the pulse generator is operated at a higher amplitude, and an attenuator is connected to the output. Avtech recommends the ATT-0444-XX-SMA-02 series of 18 GHz coaxial attenuators from Midwest Microwave, <http://www.midwestmicrowave.com/>. (The "XX" in the part number is replaced with the numeric attenuation value in dB). Three of these attenuators (10 dB, 20 dB, and 30 dB) are included in the optional -AK1 accessory kit.

### OSCILLOSCOPE SELECTION AND BANDWIDTH ISSUES

To observe a signal with a rise time of  $t_R$ , the bandwidth of the oscilloscope must exceed  $1/t_R$ . For the AVH-S-1-C,  $1/t_R = 1 / 75 \text{ ps} = 13 \text{ GHz}$ . For best results, the bandwidth of the oscilloscope (and any attenuators and cables used in the measurement system) should exceed 15 GHz.

Most oscilloscopes with suitable bandwidth are "sampling" oscilloscopes, which are more specialized in nature than slower conventional "real-time" oscilloscopes. Most sampling oscilloscopes have a very limited input voltage range ( $\pm 1\text{V}$ , for example). It is essential in these cases to use high-bandwidth attenuators on the input of the oscilloscope, to avoid over-driving or damaging the oscilloscope.

If a high-bandwidth sampling oscilloscope is not available, a slower real-time oscilloscope can be used, but the rising and falling edges will not be accurately displayed. Significant overshoot and ringing will be observed as a result of the oscilloscope's limited bandwidth. (Contrary to some user's expectations, low-bandwidth oscilloscopes *do not* "round off" the signal like a classic low-pass filter.) These are measurement artifacts, and are not normally present on the actual output.

## MINIMIZING WAVEFORM DISTORTIONS

### USE 50Ω TRANSMISSION LINES AND LOADS

Connect the load to the pulse generator with 50Ω transmission lines (e.g. RG-58 or RG-174 cable).

This instrument requires a 50Ω load for proper operation. It will not properly drive a high-impedance load. The output stage will be damaged if it is operated into an open circuit (or any other high impedance). Failures due to improper output loading are not covered by the warranty.

### USE LOW-INDUCTANCE LOADS

Lenz's Law predicts that for an inductive voltage spike will be generated when the current through an inductance changes. Specifically,  $V_{\text{SPIKE}} = L \times dI_{\text{LOAD}}/dt$ , where L is the inductance,  $I_{\text{LOAD}}$  is the load current change, and t is time. For this reason, it is important to keep any parasitic in the load low. This means keeping wiring short, and using low inductance components. In particular, wire-wound resistors should be avoided.

## PREVENTING DAMAGE

The AVH-S-1-C may fail if triggered at a PRF greater than 1 MHz.

This unit is designed to operate into a load impedance of 50 Ohms and the output stage will be damaged if it is operated into an open circuit (or any other high impedance). Failures due to improper output loading are not covered by the warranty.

The lifetime of the switching elements in the pulse generator module is proportional to the running time of the instrument. For this reason the prime power to the instrument should be turned off when the instrument is not in use.

## MECHANICAL INFORMATION

### TOP COVER REMOVAL

If necessary, the interior of the instrument may be accessed by removing the four Phillips screws on the top panel. With the four screws removed, the top cover may be slid back (and off).

 Always disconnect the power cord and allow the instrument to sit unpowered for 10 minutes before opening the instrument. This will allow any internal stored charge to discharge.

There are no user-adjustable internal circuits. For repairs other than fuse replacement, please contact Avtech (info@avtechpulse.com) to arrange for the instrument to be returned to the factory for repair. Service is to be performed solely by qualified service personnel.

 Caution: High voltages are present inside the instrument during normal operation. Do not operate the instrument with the cover removed.

### RACK MOUNTING

A rack mounting kit is available. The -R5 rack mount kit may be installed after first removing the one Phillips screw on the side panel adjacent to the front handle.

### ELECTROMAGNETIC INTERFERENCE

To prevent electromagnetic interference with other equipment, all used outputs should be connected to shielded loads using shielded coaxial cables. Unused outputs should be terminated with shielded coaxial terminators or with shielded coaxial dust caps, to prevent unintentional electromagnetic radiation. All cords and cables should be less than 3m in length.

## MAINTENANCE

### REGULAR MAINTENANCE

This instrument does not require any regular maintenance.

On occasion, one or more of the four rear-panel fuses may require replacement. All fuses can be accessed from the rear panel. See the “FUSES” section for details.

### CLEANING

If desired, the interior of the instrument may be cleaned using compressed air to dislodge any accumulated dust. (See the “TOP COVER REMOVAL” section for instructions on accessing the interior.) No other cleaning is recommended.

# WIRING DIAGRAMS

## WIRING OF AC POWER

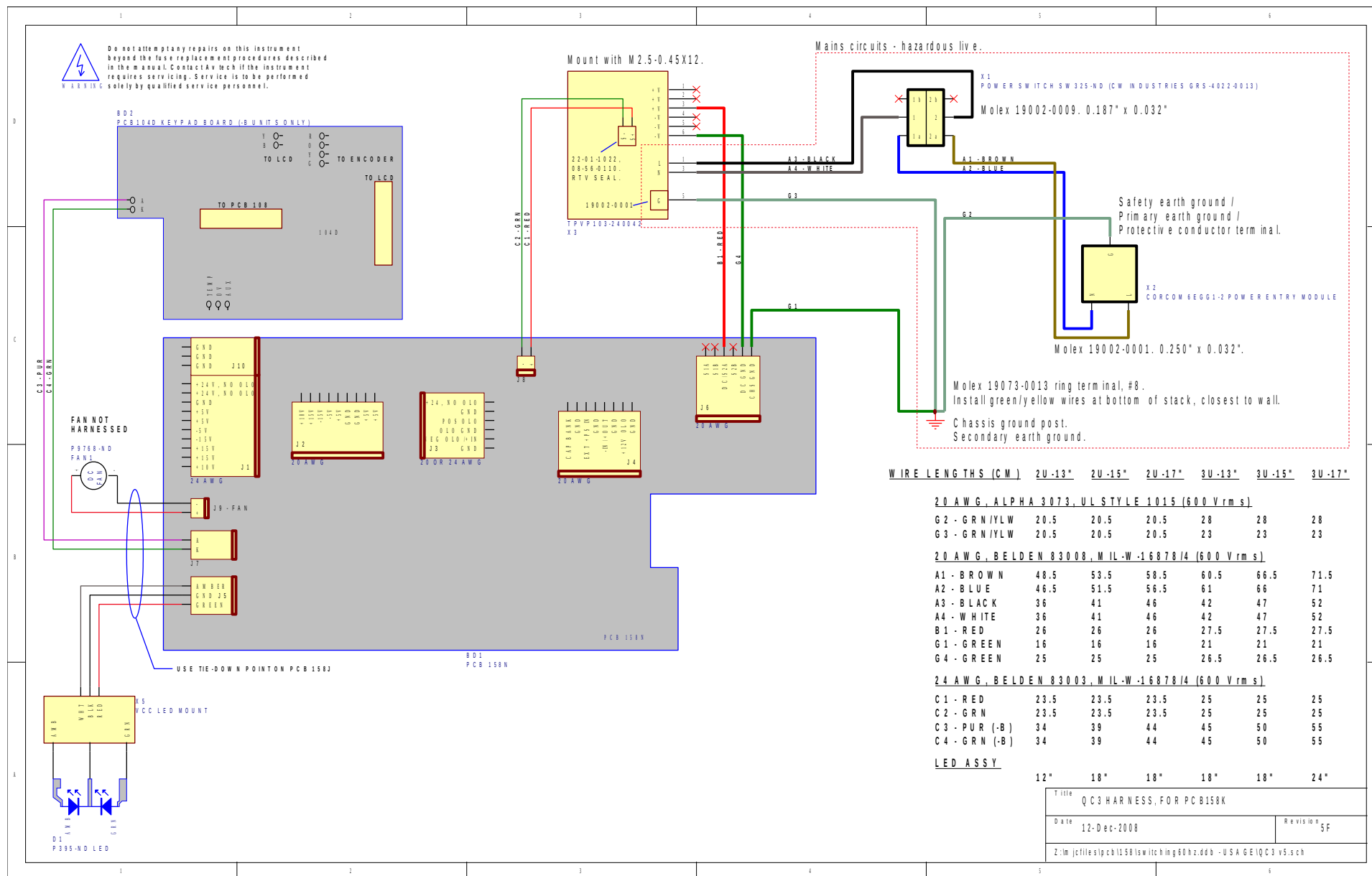

# PCB 158N - LOW VOLTAGE POWER SUPPLY, 1/3

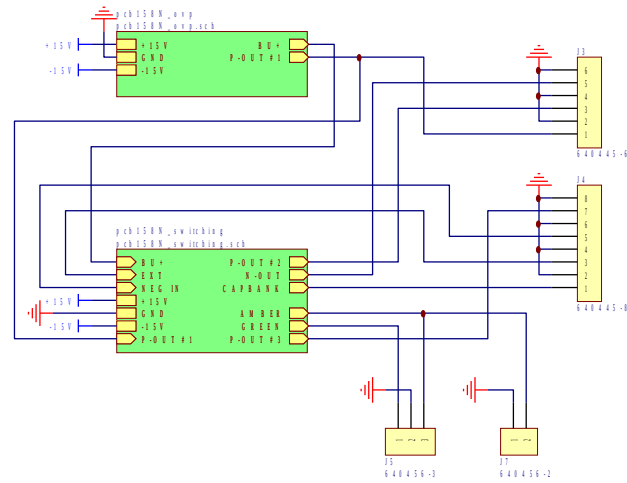

Title		LOW VOLTAGE DC/DC POWER SUPPLY
Date	12-Dec-2008	Revision
Z:\m\jcr\files\pcb158\switching\60hz.ddb - 158N\pcb158N.sch		



# PCB 158N - LOW VOLTAGE POWER SUPPLY, 2/3

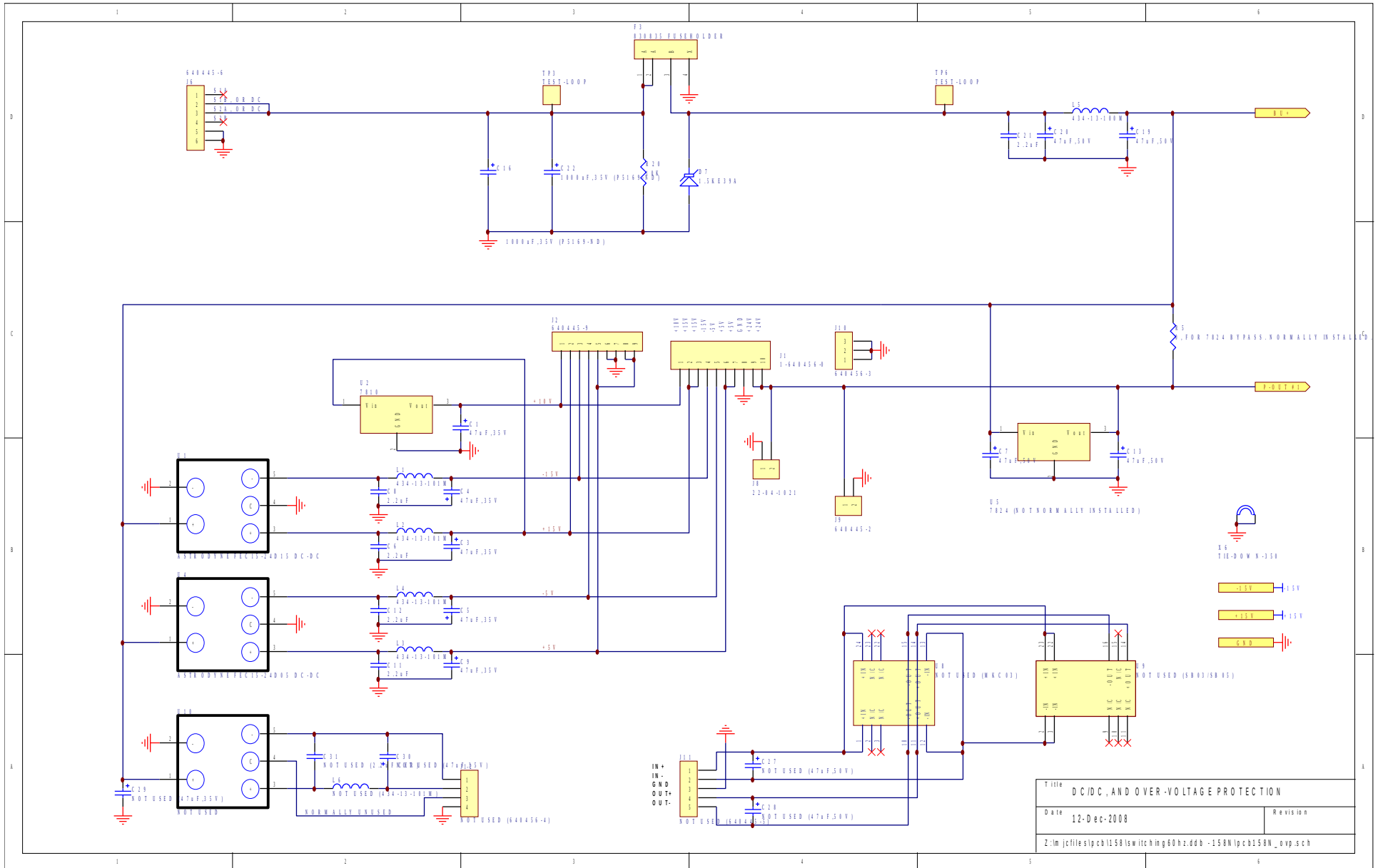



# PCB 168B - HIGH VOLTAGE DC POWER SUPPLY

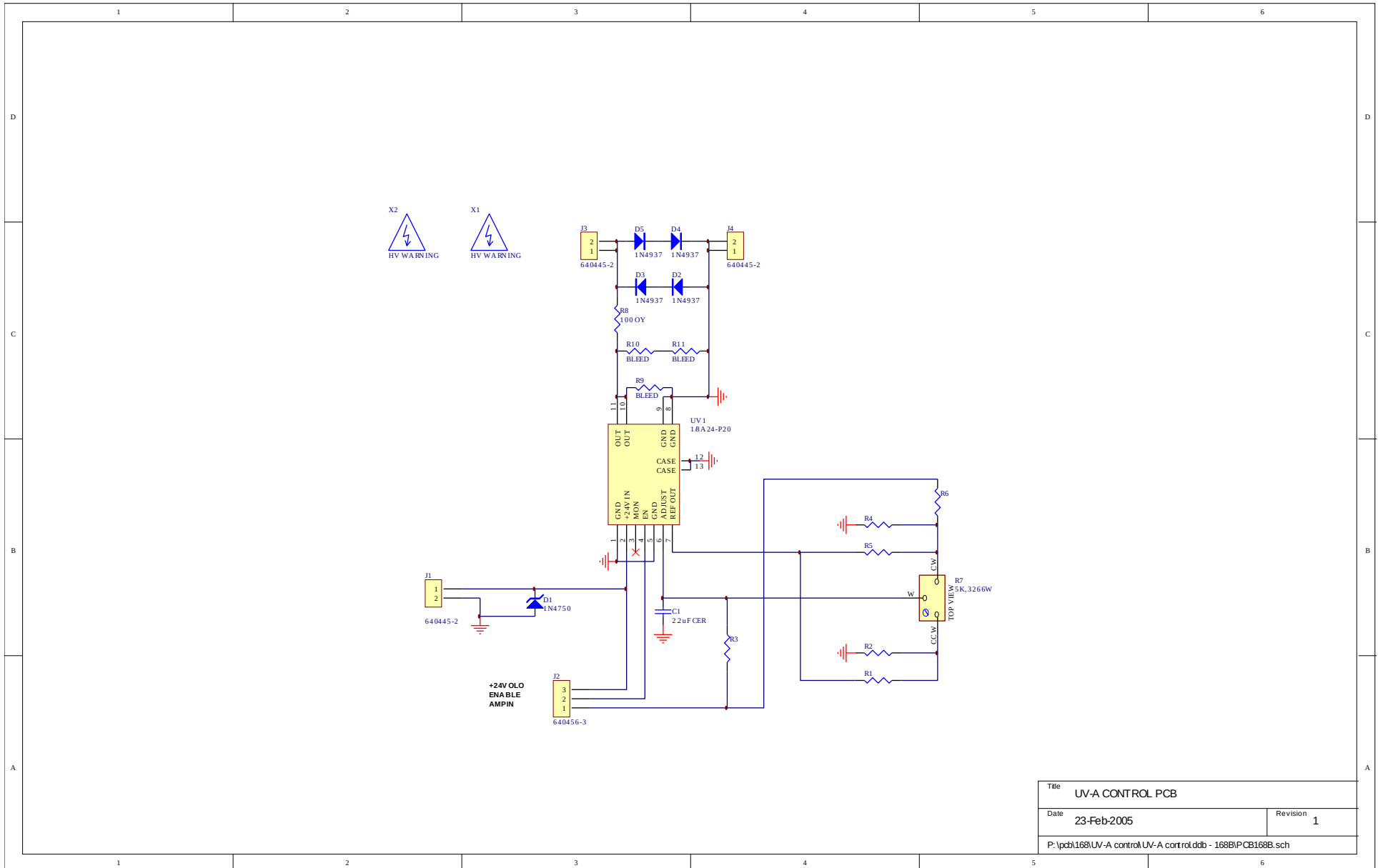

Title		UV-A CONTROL PCB
Date	23-Feb-2005	Revision 1
P:\pcb\168\UV-A control\UV-A control.dtb - 168B\PCB168B.sch		

# PCB 126C - OSCILLATOR AND TRIGGER CIRCUIT

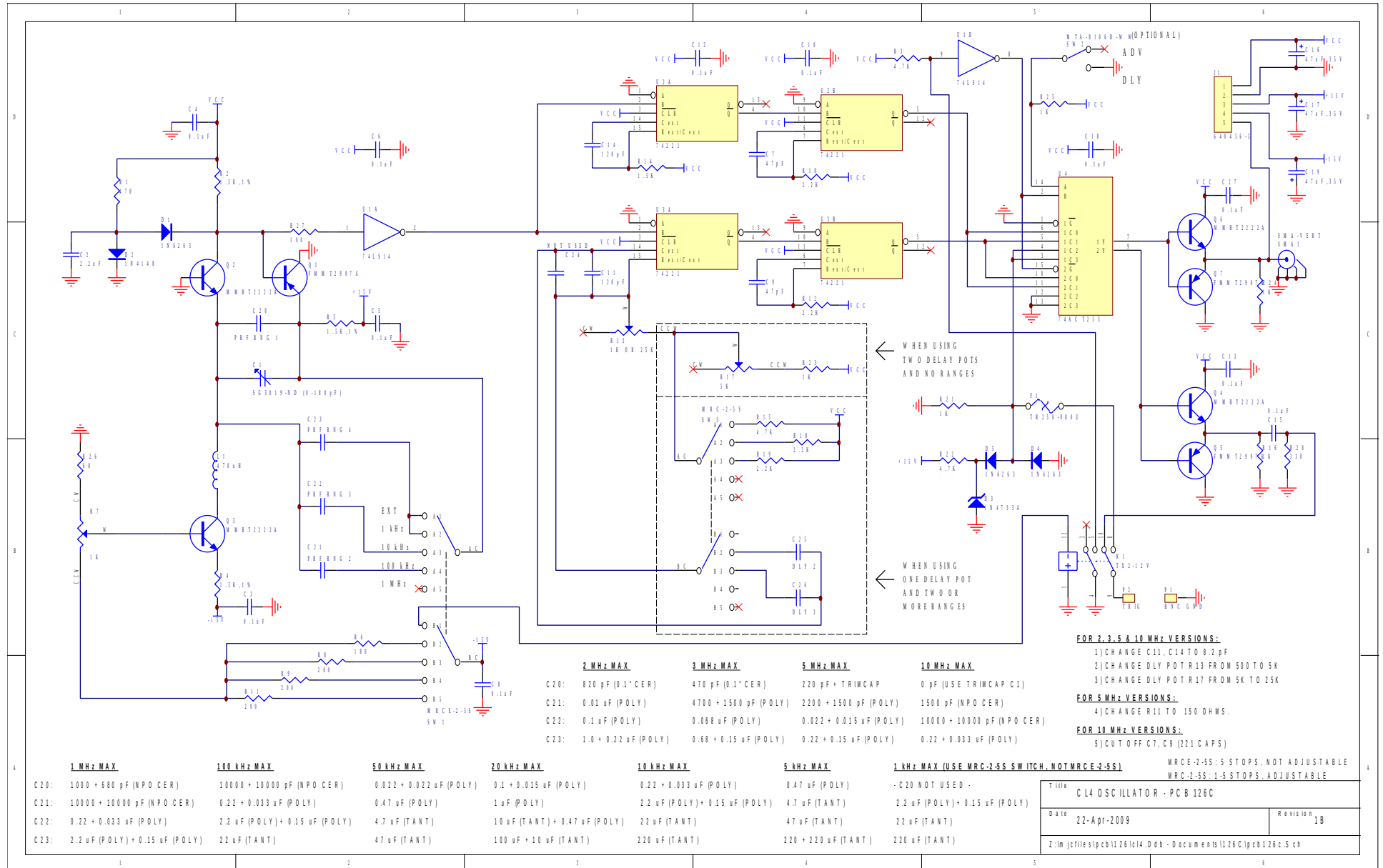





PERFORMANCE CHECK SHEET