

INSTRUCTIONS

MODEL AVH IMPULSE GENERATOR

S.N.:

WARRANTY

Avtech Electrosystems Ltd. warrants products of its manufacture to be free from defects in material and workmanship under conditions of normal use. If, within one year after delivery to the original owner, and after prepaid return by the original owner, this Avtech product is found to be defective, Avtech shall at its option repair or replace said defective item. This warranty does not apply to units which have been disassembled, modified or subjected to conditions exceeding the applicable specifications or ratings. This warranty is the extent of the obligation assumed by Avtech with respect to this product and no other warranty or guarantee is either expressed or implied.

TECHNICAL SUPPORT

Phone: 613-226-5772 or 1-800-265-6681

Fax: 613-226-2802 or 1-800-561-1970

E-mail: info@avtechpulse.com

World Wide Web: <http://www.avtechpulse.com>

TABLE OF CONTENTS

WARRANTY.....

TABLE OF CONTENTS.....

IMPULSE GENERATOR TEST ARRANGEMENT.....

GENERAL OPERATING INSTRUCTIONS.....

PERFORMANCE CHECK SHEET.....

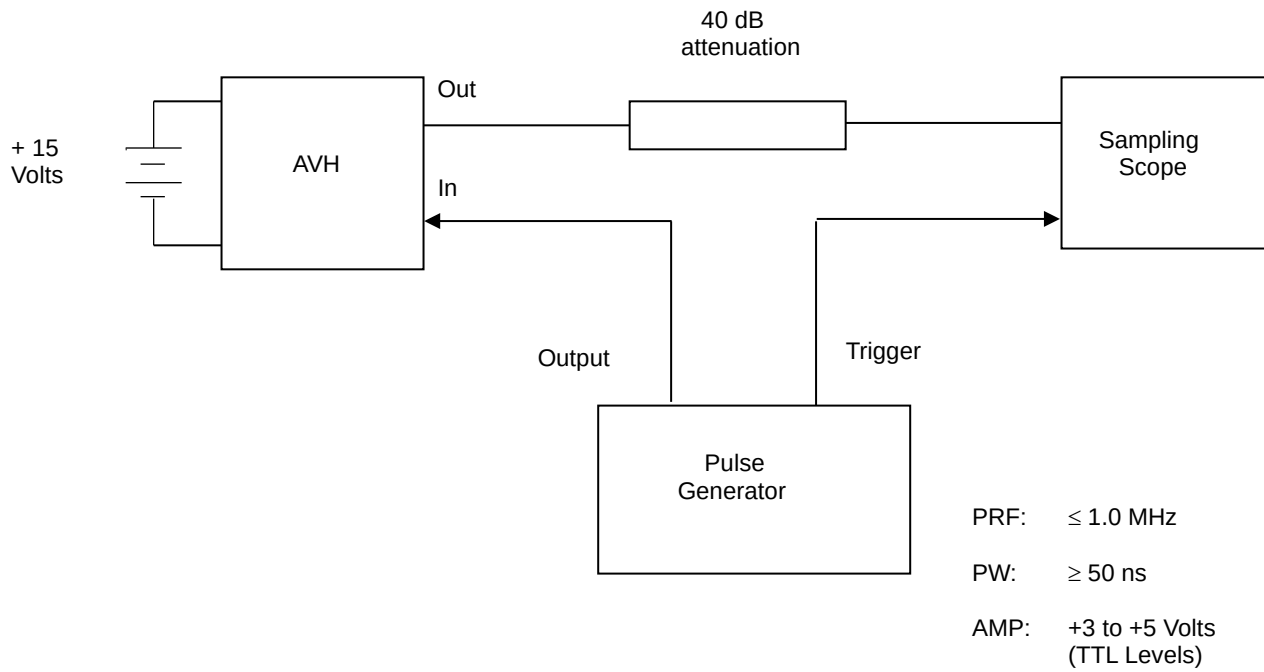
IMPULSE GENERATOR TEST ARRANGEMENT

GENERAL OPERATING INSTRUCTIONS

- 1) The bandwidth capability of components and instruments used to display the impulse generator output signal (attenuators, cables, connectors, etc.) should exceed ten gigahertz.
- 2) The use of 40 db attenuation will insure a peak input signal to the sampling scope of less than one volt.
- 3) In general, the pulse generator trigger delay control should be set in the 100 ns range. Other settings should be as shown in the above diagram. The impulse generator output is delayed with respect to the trigger input signal by about 70 ns. (typically).
- 4) The impulse generator can withstand an infinite VSWR on the output port.
- 5) To DC offset the output pulse connect a DC power supply set to the required DC offset value to the terminals marked O.S. The maximum attainable DC offset voltage is ± 50 volts (option).
- 6) For additional assistance:

Tel: (613) 226-5772

Fax: (613) 226-2802

Email: info@avtechpulse.com

PERFORMANCE CHECK SHEET