



AVTECH ELECTROSYSTEMS LTD.

NANOSECOND WAVEFORM ELECTRONICS
SINCE 1975

□ P.O. BOX 265
OGDENSBURG, NY
U.S.A. 13669-0265

TEL: 888-670-8729 (USA & Canada) or +1-613-686-6675 (Intl)
FAX: 800-561-1970 (USA & Canada) or +1-613-686-6679 (Intl)

info@avtechpulse.com - <http://www.avtechpulse.com/>

☒ BOX 5120, LCD MERIVALE
OTTAWA, ONTARIO
CANADA K2C 3H4

INSTRUCTIONS

MODEL AVN-5A-C

25 MHz TO 200 MHz

HIGH SPEED PULSE GENERATOR

WITH 200 ps RISE TIMES

SERIAL NUMBER: _____

WARRANTY

Avtech Electrosystems Ltd. warrants products of its manufacture to be free from defects in material and workmanship under conditions of normal use. If, within one year after delivery to the original owner, and after prepaid return by the original owner, this Avtech product is found to be defective, Avtech shall at its option repair or replace said defective item. This warranty does not apply to units which have been disassembled, modified or subjected to conditions exceeding the applicable specifications or ratings. This warranty is the extent of the obligation assumed by Avtech with respect to this product and no other warranty or guarantee is either expressed or implied.

TECHNICAL SUPPORT

Phone: 888-670-8729 (USA & Canada) or +1-613-686-6675 (Intl)

Fax: 800-561-1970 (USA & Canada) or +1-613-686-6679 (Intl)

E-mail: info@avtechpulse.com

World Wide Web: <http://www.avtechpulse.com>

TABLE OF CONTENTS

WARRANTY	2
TECHNICAL SUPPORT	2
TABLE OF CONTENTS	3
INTRODUCTION	5
AVAILABLE OPTIONS	5
SPECIFICATIONS	6
REGULATORY NOTES	7
FCC PART 18	7
EC DECLARATION OF CONFORMITY	7
DIRECTIVE 2002/95/EC (RoHS)	8
DIRECTIVE 2002/96/EC (WEEE)	8
INSTALLATION	9
VISUAL CHECK	9
POWER RATINGS	9
CONNECTION TO THE POWER SUPPLY	9
PROTECTION FROM ELECTRIC SHOCK	10
ENVIRONMENTAL CONDITIONS	10
FUSES	12
AC FUSE REPLACEMENT	12
DC FUSE REPLACEMENT	13
FUSE RATINGS	13
FRONT PANEL CONTROLS	14
REAR PANEL CONTROLS	16
GENERAL INFORMATION	18
BASIC TEST ARRANGEMENT	18
GENERAL OPERATING NOTES	18
MINIMIZING WAVEFORM DISTORTIONS	20
USE 50 OHM TRANSMISSION LINES AND LOADS	20
USE LOW-INDUCTANCE LOADS	20
PREVENTING DAMAGE	20
MECHANICAL INFORMATION	21
TOP COVER REMOVAL	21
RACK MOUNTING	21

ELECTROMAGNETIC INTERFERENCE.....21

MAINTENANCE.....22

REGULAR MAINTENANCE.....22

CLEANING.....22

WIRING DIAGRAMS.....23

WIRING OF AC POWER, STYLE 1.....23

WIRING OF AC POWER, STYLE 2.....24

PCB 158N - LOW VOLTAGE POWER SUPPLY, 1/3.....25

PCB 158N - LOW VOLTAGE POWER SUPPLY, 2/3.....26

PCB 158N - LOW VOLTAGE POWER SUPPLY, 3/3.....27

MAIN WIRING.....28

PERFORMANCE CHECK SHEET.....29

Manual Reference: /files/server1/officefiles/instructword/avn/AVN-5A-C,ed2.odt.
Last modified February 29, 2024.
Copyright © 2024 Avtech Electrosystems Ltd, All Rights Reserved.

INTRODUCTION

The AVN-5A-C pulse generator is a high performance instrument capable of operating at pulse repetition frequencies from 25 MHz to 200 MHz, with 200 ps rise times and 300 ps fall times.

The maximum amplitude varies with frequency. At 25 MHz, the maximum amplitude is at least 25V. At 100 MHz, the maximum amplitude is at least 30V. At 200 MHz, the maximum amplitude is at least 20V.

The pulse width is variable from 0.4 to 1.0 ns, up to 150 MHz. Above 150 MHz, the maximum pulse width falls to 0.7 ns.

Instruments with the "-P" model suffix can generate positive amplitudes, whereas instruments with the "-N" model suffix can generate negative amplitudes.

Instruments with the "-P-PN" suffix generate positive amplitudes at the main output, and are supplied with an inverting transformer that can be installed on the output to generate a negative signal.

Instruments with the "-N-PN" suffix generate negative amplitudes at the main output, and are supplied with an inverting transformer that can be installed on the output to generate a positive signal.

The output is designed to drive 50 Ω loads. (A 50 Ω load is required for proper operation.) The output is AC-coupled.

The instrument contains thermal sensors to detect overheating of the output stage. If the output stage becomes too hot, an alarm will sound and the output triggering will stop until the temperature has decreased sufficiently. If the alarm is sounded, the user should turn off the instrument for 10 minutes to allow it to cool thoroughly.

This instrument is intended for use in research and development laboratories.

AVAILABLE OPTIONS

The AVN-5A-C is available with this option:

-OT Option: an internally generated DC offset can be added to the output.

SPECIFICATIONS

Model:	AVN-5A-C ¹
Maximum amplitude ² : (50Ω load required ⁵)	25V at 25 MHz 30V at 100MHz 20V at 200MHz
Pulse width (FWHM):	0.4-1 ns (<150 MHz) 0.4-0.7 ns (>150 MHz)
Pulse repetition frequency (PRF):	25 - 200 MHz
Rise time (20%-80%):	200 ps
Fall time (20%-80%):	300 ps
Polarity ³ :	Positive or negative or both (specify)
Propagation delay:	≤ 5 ns (Ext trig in to pulse out)
Jitter:	± 15 ps (Ext trig in to pulse out)
DC offset ⁴ :	Apply required DC offset to back panel solder terminals (± 50 Volts, 250 mA max)
Trigger required:	External trigger mode: ECL-logic-level (LOW = -1.6V, HIGH = -0.8V) square wave with 50% duty cycle. The trigger input is terminated by 50 Ohms to -2V internally.
Sync output:	400 mV square wave, AC-coupled. Must be terminated with 50 Ohms to ground.
Monitor output:	Provides a -20 dB attenuated coincident replica of main output
Connectors:	Out, Monitor: SMA Trig, Sync: BNC
Power requirements:	100 - 240 Volts, 50 - 60 Hz
Dimensions:	(H x W x D) 100 x 430 x 375 mm (3.9" x 17" x 14.8")
Chassis material:	Anodized aluminum, with blue plastic trim.
Temperature range:	+5°C to +40°C

- 1) -C suffix indicates stand-alone lab instrument with internal clock and line powering. (See <http://www.avtechpulse.com/formats> for details of the basic instrument formats).
- 2) For operation at amplitudes of less than 20% of full-scale, best results will be obtained by setting the amplitude near full-scale and using external attenuators on the output.
- 3) Indicate desired polarity by suffixing the model number with -P or -N (i.e. positive or negative) or -P-PN or -N-PN for dual polarity option where the suffix preceding -PN indicates the polarity at the mainframe output port.
- 4) For internally generated DC offset option (0 to ±5 V, one-turn control) add suffix -OT to the model number.
- 5) A 50 Ohm load is required. Other loads may damage the instrument. Consult Avtech (info@avtechpulse.com) if you need to drive other load impedances.

REGULATORY NOTES

FCC PART 18

This device complies with part 18 of the FCC rules for non-consumer industrial, scientific and medical (ISM) equipment.

This instrument is enclosed in a rugged metal chassis and uses a filtered power entry module. The main output signal is provided on a shielded connector that is intended to be used with shielded coaxial cabling and a shielded load. Under these conditions, the interference potential of this instrument is low.

If interference is observed, check that appropriate well-shielded cabling is used on the output connectors. Contact Avtech (info@avtechpulse.com) for advice if you are unsure of the most appropriate cabling. Also, check that your load is adequately shielded. It may be necessary to enclose the load in a metal enclosure.

If any of the connectors on the instrument are unused, they should be covered with shielded metal "dust caps" to reduce the interference potential.

This instrument does not normally require regular maintenance to minimize interference potential. However, if loose hardware or connectors are noted, they should be tightened. Contact Avtech (info@avtechpulse.com) if you require assistance.

EC DECLARATION OF CONFORMITY



We Avtech Electrosystems Ltd.
 P.O. Box 5120, LCD Merivale
 Ottawa, Ontario
 Canada K2C 3H4

declare that this pulse generator meets the intent of Directive 89/336/EEC for Electromagnetic Compatibility. Compliance pertains to the following specifications as listed in the official Journal of the European Communities:

EN 50081-1 Emission

EN 50082-1 Immunity

and that this pulse generator meets the intent of the Low Voltage Directive 72/23/EEC as amended by 93/68/EEC. Compliance pertains to the following specifications as listed in the official Journal of the European Communities:

EN 61010-1:2001 Safety requirements for electrical equipment for measurement, control, and laboratory use

DIRECTIVE 2002/95/EC (RoHS)

This instrument is exempt from Directive 2002/95/EC of the European Parliament and of the Council of 27 January 2003 on the Restriction of the use of certain Hazardous Substances (RoHS) in electrical and electronic equipment. Specifically, Avtech instruments are considered "Monitoring and control instruments" (Category 9) as defined in Annex 1A of Directive 2002/96/EC. The Directive 2002/95/EC only applies to Directive 2002/96/EC categories 1-7 and 10, as stated in the "Article 2 - Scope" section of Directive 2002/95/EC.

DIRECTIVE 2002/96/EC (WEEE)

European customers who have purchased this equipment directly from Avtech will have completed a "WEEE Responsibility Agreement" form, accepting responsibility for WEEE compliance (as mandated in Directive 2002/96/EC of the European Union and local laws) on behalf of the customer, as provided for under Article 9 of Directive 2002/96/EC.

Customers who have purchased Avtech equipment through local representatives should consult with the representative to determine who has responsibility for WEEE compliance. Normally, such responsibilities will lie with the representative, unless other arrangements (under Article 9) have been made.

Requirements for WEEE compliance may include registration of products with local governments, reporting of recycling activities to local governments, and financing of recycling activities.



INSTALLATION

VISUAL CHECK

After unpacking the instrument, examine to ensure that it has not been damaged in shipment. Visually inspect all connectors, knobs, and handles. Confirm that a power cord is with the instrument. If the instrument has been damaged, file a claim immediately with the company that transported the instrument.

POWER RATINGS

This instrument is intended to operate from 100 - 240 V, 50 - 60 Hz.

The maximum power consumption is 115 Watts. Please see the “FUSES” section for information about the appropriate AC and DC fuses.

This instrument is an “Installation Category II” instrument, intended for operation from a normal single-phase supply.

CONNECTION TO THE POWER SUPPLY

An IEC-320 three-pronged recessed male socket is provided on the back panel for AC power connection to the instrument. One end of the detachable power cord that is supplied with the instrument plugs into this socket. The other end of the detachable power cord plugs into the local mains supply. Use only the cable supplied with the instrument. The mains supply must be earthed, and the cord used to connect the instrument to the mains supply must provide an earth connection. (The supplied cord does this.)

 Warning: Failure to use a grounded outlet may result in injury or death due to electric shock. This product uses a power cord with a ground connection. It must be connected to a properly grounded outlet. The instrument chassis is connected to the ground wire in the power cord.

The table below describes the power cord that is normally supplied with this instrument, depending on the destination region:

Destination Region	Description	Manufacturer	Part Number
Continental Europe	European CEE 7/7 "Schuko" 230V, 50Hz	Qualtek (http://www.qualtekusa.com)	319004-T01
United Kingdom	BS 1363, 230V, 50Hz	Qualtek (http://www.qualtekusa.com)	370001-E01
Switzerland	SEV 1011, 2 30V, 50Hz	Volex (http://www.volex.com)	2102H-C3-10
Israel	SI 32, 220V, 50Hz	Volex (http://www.volex.com)	2115H-C3-10
North America, and all other areas	NEMA 5-15, 120V, 60 Hz	Qualtek (http://www.qualtekusa.com)	312007-01

PROTECTION FROM ELECTRIC SHOCK

 Operators of this instrument must be protected from electric shock at all times. The owner must ensure that operators are prevented access and/or are insulated from every connection point. In some cases, connections must be exposed to potential human contact. Operators must be trained to protect themselves from the risk of electric shock. This instrument is intended for use by qualified personnel who recognize shock hazards and are familiar with safety precautions required to avoid possibly injury. In particular, operators should:

1. Keep exposed high-voltage wiring to an absolute minimum.
2. Wherever possible, use shielded connectors and cabling.
3. Connect and disconnect loads and cables only when the instrument is turned off.
4. Keep in mind that all cables, connectors, oscilloscope probes, and loads must have an appropriate voltage rating.
5. Do not attempt any repairs on the instrument, beyond the fuse replacement procedures described in this manual. Contact Avtech technical support (see page 2 for contact information) if the instrument requires servicing. Service is to be performed solely by qualified service personnel.

ENVIRONMENTAL CONDITIONS

This instrument is intended for use under the following conditions:

1. indoor use;
2. altitude up to 2 000 m;
3. temperature 5 °C to 40 °C;

4. maximum relative humidity 80 % for temperatures up to 31 °C decreasing linearly to 50 % relative humidity at 40 °C;
5. Mains supply voltage fluctuations up to ± 10 % of the nominal voltage;
6. no pollution or only dry, non-conductive pollution.

FUSES

This instrument contains four fuses. All are accessible from the rear-panel. Two protect the AC prime power input, and two protect the internal DC power supplies. The locations of the fuses on the rear panel are shown in the figure below:



AC FUSE REPLACEMENT

To physically access the AC fuses, the power cord must be detached from the rear panel of the instrument. The fuse drawer may then be extracted using a small flat-head screwdriver, as shown below:



DC FUSE REPLACEMENT

The DC fuses may be replaced by inserting the tip of a flat-head screwdriver into the fuse holder slot, and rotating the slot counter-clockwise. The fuse and its carrier will then pop out.

FUSE RATINGS

The following table lists the required fuses:

Fuses	Nominal Mains Voltage	Rating	Case Size	Recommended Replacement Part	
				Littelfuse Part Number	Digi-Key Stock Number
#1, #2 (AC)	115 V	1.0A, 250V, Time-Delay	5×20 mm	0218001.HXP	F2419-ND
	230 V	0.5A, 250V, Time-Delay	5×20 mm	0218.500HXP	F2416-ND
#3 (DC)	N/A	3.15A, 250V, Time-Delay	5×20 mm	02183.15HXP	F2430-ND
#4 (DC)	N/A	2.5A, 250V, Time-Delay	5×20 mm	021802.5HXP	F2427-ND

The recommended fuse manufacturer is Littelfuse (<http://www.littelfuse.com>).

Replacement fuses may be easily obtained from Digi-Key (<http://www.digikey.com>) and other distributors.

FRONT PANEL CONTROLS

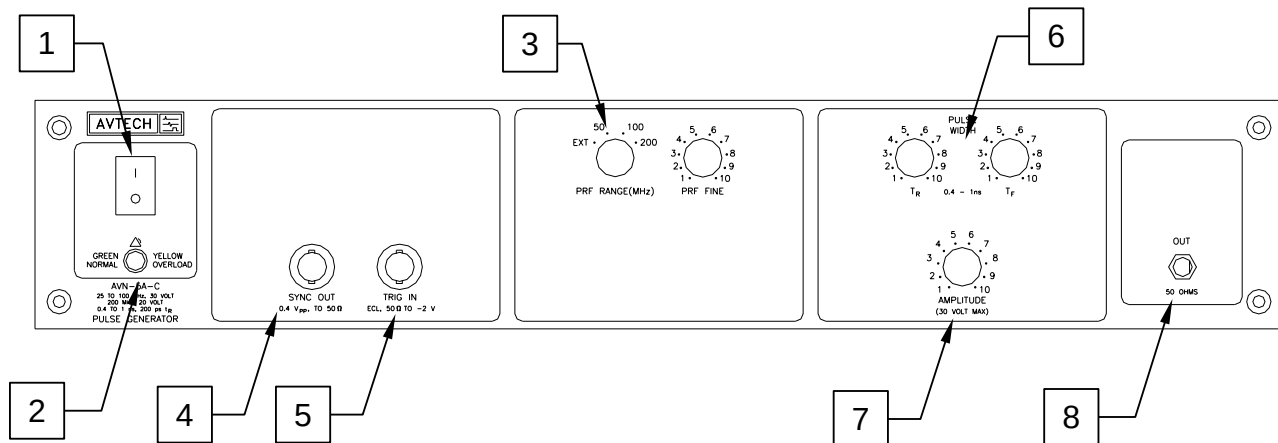

- 1) POWER Switch. This is the main power switch. When turning the instrument on, there may be a delay of several seconds before the instrument appears to respond.
- 2) OVERLOAD Indicator. When the instrument is powered, this indicator is normally green, indicating normal operation. If this indicator is yellow, an internal automatic overload protection circuit has been tripped. If the unit is overloaded (by operating at an exceedingly high duty cycle or by operating into a very low impedance), the protective circuit will disable the output of the instrument and turn the indicator light yellow. The light will stay yellow (i.e. output disabled) for about 5 seconds after which the instrument will attempt to re-enable the output (i.e. light green) for about 1 second. If the overload condition persists, the output will be disabled again (i.e. light yellow) for another 5 seconds. If the overload condition has been removed, the instrument will resume normal operation.

This overload indicator may flash yellow briefly at start-up. This is not a cause for concern.

- 3) PRF Range Switch. This switch sets the pulse repetition frequency (PRF) range of the internal oscillator. The marked value of each position is the upper limit of the 2:1 range, approximately. The vernier dial beside the switch varies the PRF within the set range.

If this switch is set to the “EXT” position, the instrument is triggered by a signal applied to the TRIG connector, rather than by the internal oscillator.

- 4) TRIG Connector. When the PRF Range Switch is set to “EXT”, the instrument is triggered by an ECL-level (LOW = -1.6V, HIGH = -0.8V) square wave (50% duty cycle) applied to this connector. This input is terminated internally with 50 Ohms to -2V.

- 5) SYNC Connector. This output may be used to trigger oscilloscopes or other equipment. It is active in both the internal and external trigger modes. This output provides an AC-coupled 400 mV (peak-to-peak) square wave with the same pulse repetition frequency as the main output.
- 6) Pulse Width Control. These two one-turn controls vary the output pulse width and pulse shape. TR controls the leading edge of the pulse while TF controls the falling edge. Clockwise rotation of TR and TF increases the output pulse width. See the “General Operating Notes” section for more details.
- 7) Amplitude Control. This dial controls the amplitude.
- 8) OUT Connector. This SMA connector provides the main output to a 50 Ohm load.

Optional controls (not shown in the diagram):

OFFSET Control. (Present units with the -OT option only.) This controls the DC offset added to the output, in the range of -5V to +5V. The rear-panel OT On/Off switch must be in the “On” position for this function to be enabled.

REAR PANEL CONTROLS

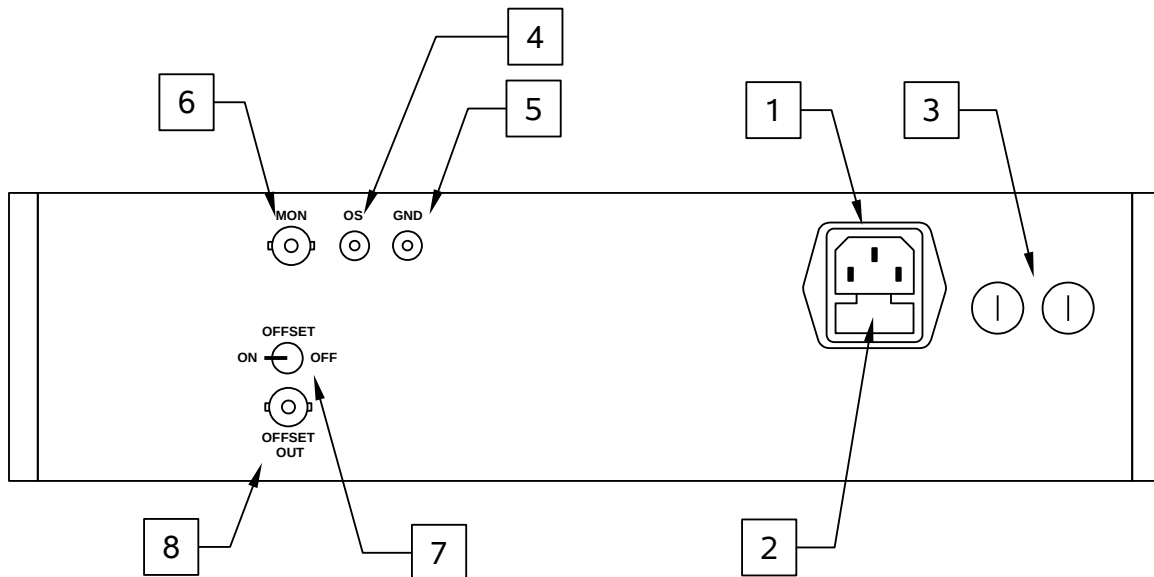

1. AC POWER INPUT. An IEC-320 C14 three-pronged recessed male socket is provided on the back panel for AC power connection to the instrument. One end of the detachable power cord that is supplied with the instrument plugs into this socket.
2. AC FUSE DRAWER. The two fuses that protect the AC input are located in this drawer. Please see the “FUSES” section of this manual for more information.
3. DC FUSES. These two fuses protect the internal DC power supplies. Please see the “FUSES” sections of this manual for more information.
4. OS INPUT CONNECTOR. (For units without the -OT option.) A DC offset in the range of $\pm 50\text{V}$ (250 mA max) may be applied to this solder terminal. The DC offset will appear on the output. When this feature is not used, the OS input should be connected to ground (using the adjacent GND connector). This is especially important when driving loads containing a diode.
5. GND CONNECTOR. (For units without the -OT option.) This solder terminal is connected to ground. It may be used to ground the OS input connector.
6. M OUTPUT CONNECTOR. This SMA connector output provides a 20 dB attenuated coincident replica of main output, for monitoring purposes.
7. OT ON/OFF SWITCH. (Present on units with -OT option only.) This switch enables or disables the front-panel offset dial and the associated internal offset generation circuitry.

8. OT OUT CONNECTOR. (Present on units with -OT option only.) This BNC connector provides access to the internally-generated DC offset voltage when the OT ON/OFF switch is set to "ON".

GENERAL INFORMATION

BASIC TEST ARRANGEMENT

The AVN-5A-C should be tested with a sampling oscilloscope with a bandwidth of at least 10 GHz to properly observe the high-speed waveform. A typical test arrangement is shown below:

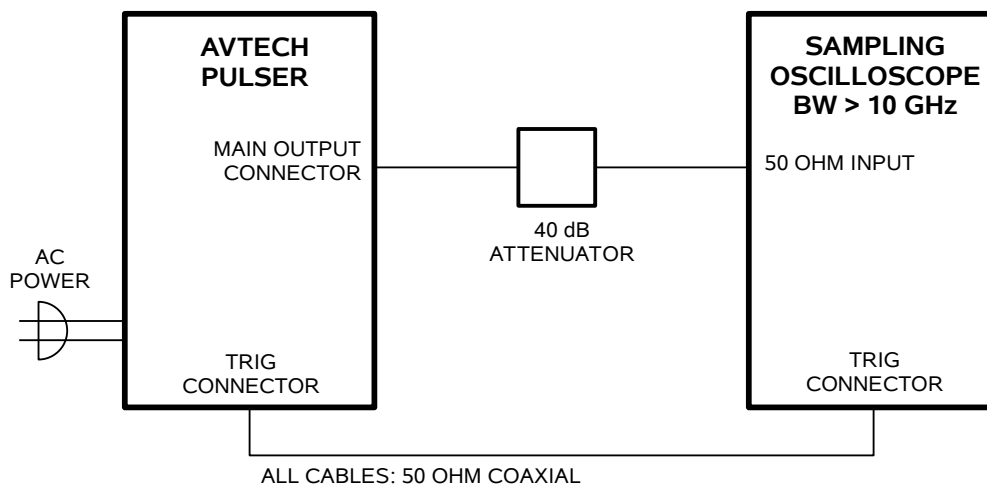

The attenuators are required to prevent damage to the sampling oscilloscope. A 40 dB attenuator with sufficient voltage rating should be used on the main output.

GENERAL OPERATING NOTES

- 1) The bandwidth capability of components and instruments used to display the pulse generator output signal (attenuators, cables, connectors, etc.) should exceed 10 GHz.
- 2) The use of 40 dB attenuator at the sampling scope vertical input channel will insure a peak input signal to the sampling scope of less than 1 Volt.
- 3) The SYNC output provides a 400 mV square wave (to 50 Ohms).
- 4) To obtain a stable output display the PRF and PRF FINE controls on the front panel should be set mid-range initially.
- 5) The output pulse shape is determined by the two front panel controls TR and TF. TR controls the leading edge of the pulse while TF controls the falling edge. Clockwise rotation of TR and TF increases the output pulse width. Initially rotate the TF pot fully clockwise and set the TR pot at mid-range. The output amplitude is controlled by the front panel AMP control and by the input signal level. Initially the AMP control should be set maximum clockwise. The oscilloscope display will

resemble the following:

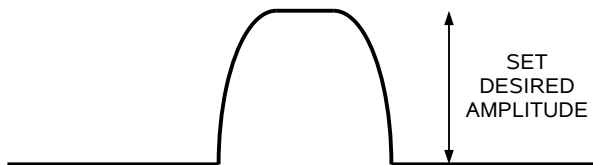

- 6) Having obtained a display of the form shown above, the desired pulse width is then obtained by adjusting the two front panel pots TR and TF. Rotate TR counter clockwise from the position set earlier until a sharp 200 ps leading edge is observed. Then rotate TF counterclockwise until the desired pulse width and fall time are obtained.

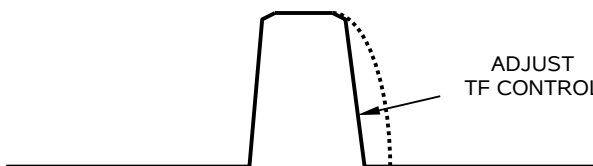
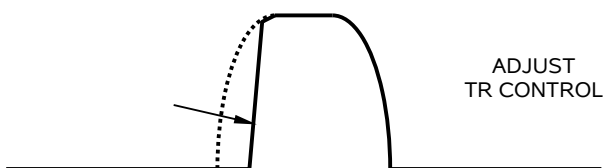

- 7) Further iterative adjustments of TR and TF will be necessary to simultaneously obtain the lowest rise time, lowest fall time, the desired pulse width, and pulse top shape, and low spurious signal level. In addition some additional adjustment of signal level may be necessary to obtain the desired amplitude. If the input frequency is then changed it will be necessary to readjust AMP, TR and TF to establish the required pulse shape. Following the above sequence it is possible to generate output pulses having amplitudes of at least 25V at 25 MHz, 30V at 100 MHz, and 20V at 200 MHz.

WARNING: Do not operate below 25 MHz as failure may result. Also, do not exceed 30 Volts out as this too may result in failure. Failures due to operating at output signals higher than 30 Volts are not covered by the warranty.

- 8) To DC offset the output pulse connect a DC power supply set to required DC offset value to the back panel terminals marked OS. The maximum attainable DC offset is $\pm 50V$ (250 mA max). (For units without the OT option only).

MINIMIZING WAVEFORM DISTORTIONS

USE 50 OHM TRANSMISSION LINES AND LOADS

Connect the load to the pulse generator with 50 Ω transmission lines (e.g. RG-58 or RG-174 cable).

This instrument requires a 50 Ω load for proper operation. It will not properly drive a high-impedance load. The output stage will be damaged if it is operated into an open circuit (or any other high impedance). Failures due to improper output loading are not covered by the warranty.

USE LOW-INDUCTANCE LOADS

Lenz's Law predicts that for an inductive voltage spike will be generated when the current through an inductance changes. Specifically, $V_{\text{SPIKE}} = L \times dI_{\text{LOAD}}/dt$, where L is the inductance, I_{LOAD} is the load current change, and t is time. For this reason, it is important to keep any parasitic in the load low. This means keeping wiring short, and using low inductance components. In particular, wire-wound resistors should be avoided.

PREVENTING DAMAGE

The AVN-5A-C may fail if triggered at a PRF greater than 200 MHz.

This unit is designed to operate into a load impedance of 50 Ohms and the output stage will be damaged if it is operated into an open circuit (or any other high impedance). Failures due to improper output loading are not covered by the warranty.

The lifetime of the switching elements in the pulse generator module is proportional to the running time of the instrument. For this reason the prime power to the instrument should be turned off when the instrument is not in use.

The instrument contains thermal sensors to detect overheating of the output stage. If the output stage becomes too hot, an alarm will sound and the output triggering will stop until the temperature has decreased sufficiently. If the alarm is sounded, the user should turn off the instrument for 10 minutes to allow it to cool thoroughly.

MECHANICAL INFORMATION

TOP COVER REMOVAL

If necessary, the interior of the instrument may be accessed by removing the four Phillips screws on the top panel. With the four screws removed, the top cover may be slid back (and off).

 Always disconnect the power cord and allow the instrument to sit unpowered for 10 minutes before opening the instrument. This will allow any internal stored charge to discharge.

There are no user-adjustable internal circuits. For repairs other than fuse replacement, please contact Avtech (info@avtechpulse.com) to arrange for the instrument to be returned to the factory for repair. Service is to be performed solely by qualified service personnel.

 Caution: High voltages are present inside the instrument during normal operation. Do not operate the instrument with the cover removed.

RACK MOUNTING

A rack mounting kit is available. The -R5 rack mount kit may be installed after first removing the one Phillips screw on the side panel adjacent to the front handle.

ELECTROMAGNETIC INTERFERENCE

To prevent electromagnetic interference with other equipment, all used outputs should be connected to shielded loads using shielded coaxial cables. Unused outputs should be terminated with shielded coaxial terminators or with shielded coaxial dust caps, to prevent unintentional electromagnetic radiation. All cords and cables should be less than 3m in length.

MAINTENANCE

REGULAR MAINTENANCE

This instrument does not require any regular maintenance.

On occasion, one or more of the four rear-panel fuses may require replacement. All fuses can be accessed from the rear panel. See the “FUSES” section for details.

CLEANING

If desired, the interior of the instrument may be cleaned using compressed air to dislodge any accumulated dust. (See the “TOP COVER REMOVAL” section for instructions on accessing the interior.) No other cleaning is recommended.

WIRING DIAGRAMS

WIRING OF AC POWER, STYLE 1

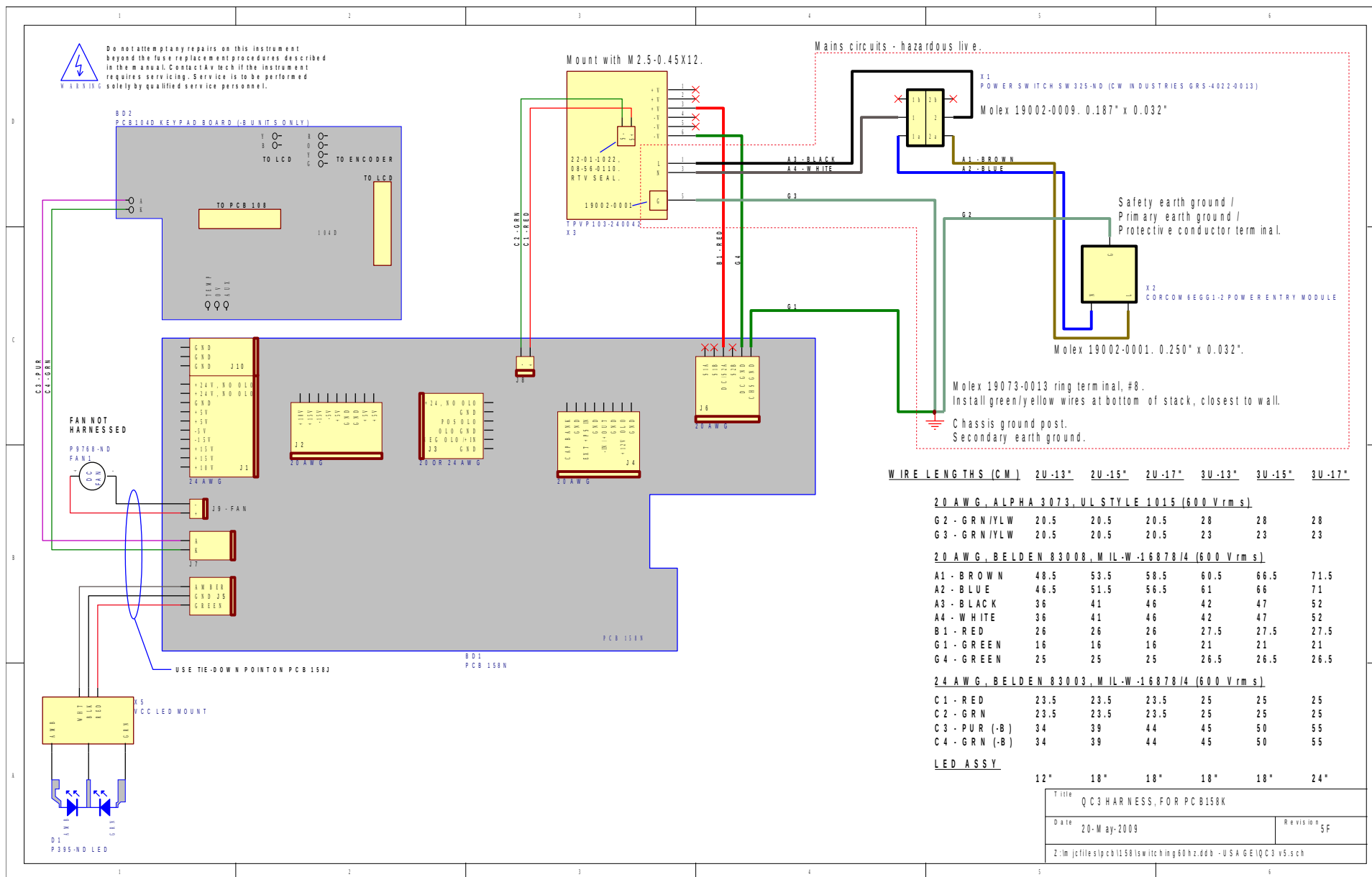

WIRING OF AC POWER, STYLE 2

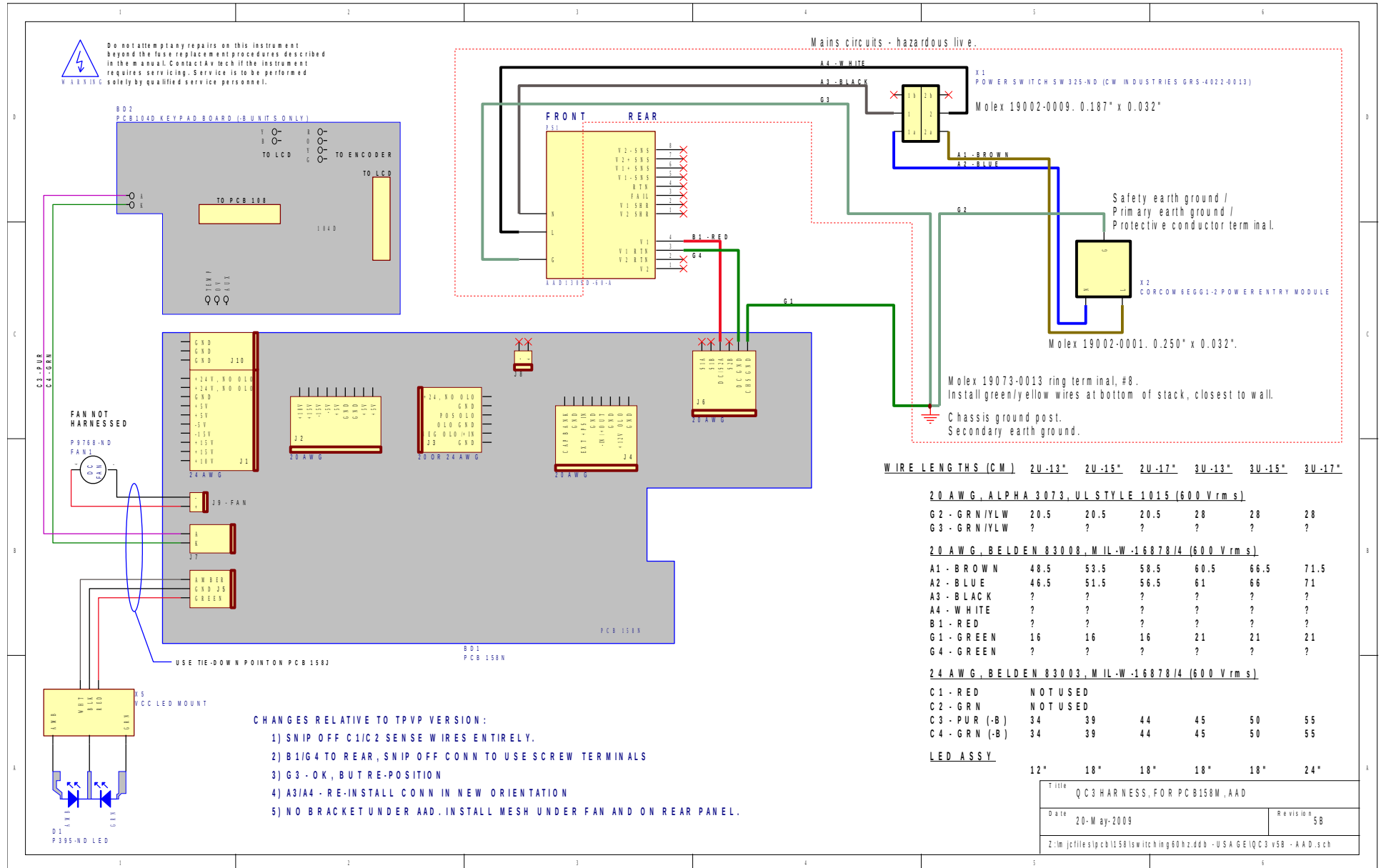

Title QCS HARNESS, FOR PCB158N, AAD	
Date 20-May-2009	Revision 5B
Z:\m\j\files\ipch\158\sw\itc\hng\00hz.dbb - USA GE\QC3 v5B - AAD.sch	

PCB 158N - LOW VOLTAGE POWER SUPPLY, 1/3

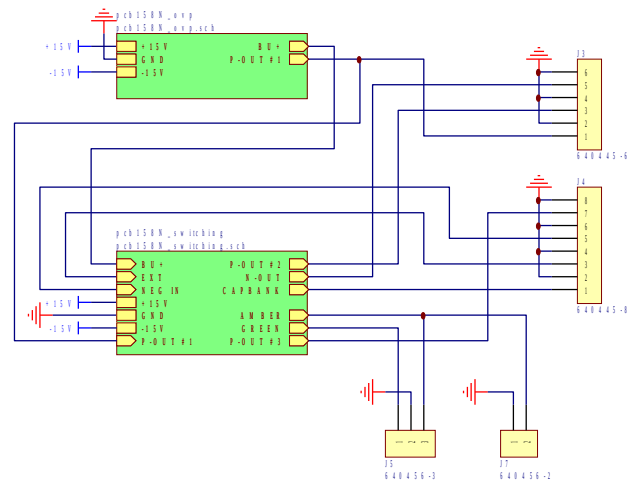

Title		LOW VOLTAGE DC/DC POWER SUPPLY
Date	12-Dec-2008	Revision
Z:\m\jcf\files\pcb\158\switching\60hz.ddb - 158N\ipc\0158N.sch		

PCB 158N - LOW VOLTAGE POWER SUPPLY, 2/3

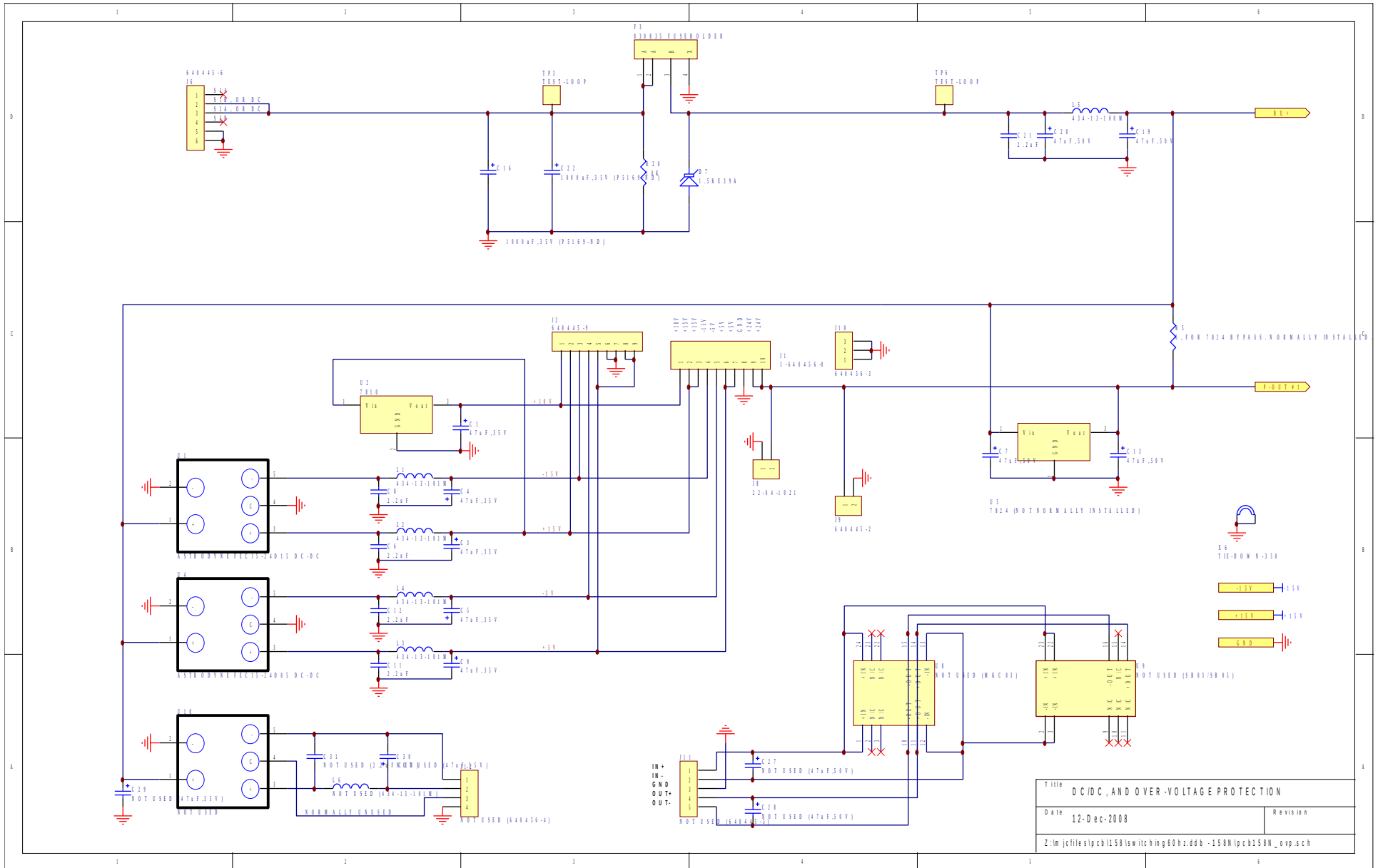

MAIN WIRING

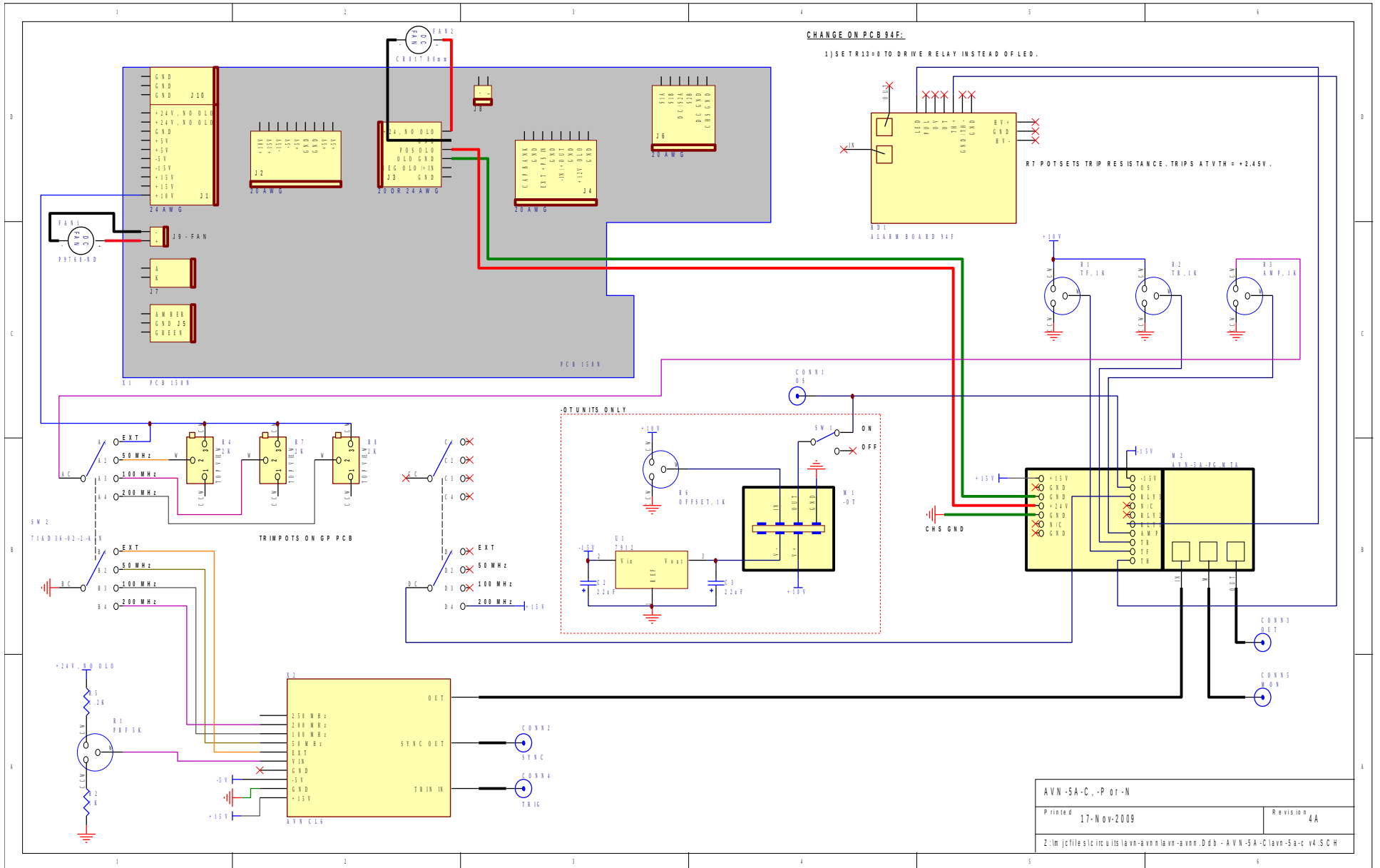

PERFORMANCE CHECK SHEET