



AVTECH ELECTROSYSTEMS LTD.

NANOSECOND WAVEFORM ELECTRONICS
SINCE 1975

P.O. BOX 265
OGDENSBURG, NY
U.S.A. 13669-0265

TEL: 888-670-8729 (USA & Canada) or +1-613-686-6675 (Intl)
FAX: 800-561-1970 (USA & Canada) or +1-613-686-6679 (Intl)

info@avtechpulse.com - <http://www.avtechpulse.com/>

BOX 5120, LCD MERIVALE
OTTAWA, ONTARIO
CANADA K2C 3H4

INSTRUCTIONS

MODEL AVN-W2-C

10 - 75 MHz, 8 VOLT

HIGH SPEED PULSE GENERATOR

WITH 200 ps RISE TIMES

SERIAL NUMBER: _____

WARRANTY

Avtech Electrosystems Ltd. warrants products of its manufacture to be free from defects in material and workmanship under conditions of normal use. If, within one year after delivery to the original owner, and after prepaid return by the original owner, this Avtech product is found to be defective, Avtech shall at its option repair or replace said defective item. This warranty does not apply to units which have been disassembled, modified or subjected to conditions exceeding the applicable specifications or ratings. This warranty is the extent of the obligation assumed by Avtech with respect to this product and no other warranty or guarantee is either expressed or implied.

TECHNICAL SUPPORT

Phone: 888-670-8729 (USA & Canada) or +1-613-686-6675 (International)

Fax: 800-561-1970 (USA & Canada) or +1-613-686-6679 (International)

E-mail: info@avtechpulse.com

World Wide Web: <http://www.avtechpulse.com>

TABLE OF CONTENTS

WARRANTY	2
TECHNICAL SUPPORT	2
TABLE OF CONTENTS	3
INTRODUCTION	5
AVAILABLE OPTIONS	5
SPECIFICATIONS	6
REGULATORY NOTES	7
FCC PART 18	7
EC DECLARATION OF CONFORMITY	7
DIRECTIVE 2011/65/EU (RoHS)	8
DIRECTIVE 2002/96/EC (WEEE)	8
INSTALLATION	10
VISUAL CHECK	10
POWER RATINGS	10
CONNECTION TO THE POWER SUPPLY	10
PROTECTION FROM ELECTRIC SHOCK	11
ENVIRONMENTAL CONDITIONS	12
FUSES	13
AC FUSE REPLACEMENT	13
DC FUSE REPLACEMENT	14
FUSE RATINGS	14
FRONT PANEL CONTROLS	15
REAR PANEL CONTROLS	17
GENERAL INFORMATION	19
BASIC TEST ARRANGEMENT	19
CONTROLLING THE PULSE SHAPE	19
AMPLITUDE INTERACTION	20
POLARITY INVERSION	20
OPERATION AT LOW AMPLITUDES	21
OSCILLOSCOPE SELECTION AND BANDWIDTH ISSUES	21
MINIMIZING WAVEFORM DISTORTIONS	22
USE 50 OHM TRANSMISSION LINES AND LOADS	22
USE LOW-INDUCTANCE LOADS	22

PREVENTING DAMAGE	22
OPTIONS	23
-OT OPTION.....	23
-M OPTION.....	23
MECHANICAL INFORMATION	24
TOP COVER REMOVAL.....	24
RACK MOUNTING.....	24
ELECTROMAGNETIC INTERFERENCE.....	24
MAINTENANCE	25
REGULAR MAINTENANCE.....	25
CLEANING.....	25
WIRING DIAGRAMS	26
WIRING OF AC POWER.....	26
PCB 158P - LOW VOLTAGE POWER SUPPLY, 1/3.....	27
PCB 158P - LOW VOLTAGE POWER SUPPLY, 2/3.....	28
PCB 158P - LOW VOLTAGE POWER SUPPLY, 3/3.....	29
PCB 231A - INTERNAL DC OFFSET FUNCTION.....	30
MAIN WIRING.....	31
PERFORMANCE CHECK SHEET	32

Manual Reference: /filesserver1/officefiles/instructword/avn/AVN-W2-C,ed1.odt.

Last modified February 29, 2024.

Copyright © 2024 Avtech Electrosystems Ltd, All Rights Reserved.

INTRODUCTION

The AVN-W2-C pulse generator is a high performance instrument capable of operating at pulse repetition frequencies from 10 MHz to 75 MHz, with 200 ps rise and fall times. The minimum pulse width is 1 ns. The maximum pulse width is 10 ns up to 40 MHz, and 5 ns above that. The maximum amplitude is 8V.

Instruments with the "-P" model suffix can generate positive amplitudes, whereas instruments with the "-N" model suffix can generate negative amplitudes.

Instruments with the "-P-PN" suffix generate positive amplitudes at the main output, and are supplied with an inverting transformer that can be installed on the output to generate a negative signal.

Instruments with the "-N-PN" suffix generate negative amplitudes at the main output, and are supplied with an inverting transformer that can be installed on the output to generate a positive signal.

The output is designed to drive 50Ω loads. (A 50Ω load is required for proper operation.) The output is AC-coupled.

This instrument is intended for use in research, development, test and calibration laboratories by qualified personnel.

AVAILABLE OPTIONS

The AVN-W2-C is available with several options:

-OT Option: an internally generated DC offset can be added to the output.

-M Option: a monitor output is provided.

SPECIFICATIONS

Model:	AVN-W2-C ¹
Maximum amplitude ² : (50Ω load required ⁵):	8V
Pulse width, minimum: (FWHM) maximum:	1 ns
	10 ns (< 40 MHz) 5 ns (> 40 MHz)
Pulse repetition frequency (PRF):	10 - 75 MHz
Rise time (20%-80%):	200 ps
Fall time (20%-80%):	200 ps
Polarity ³ :	Positive or negative or both (specify)
Propagation delay:	≤ 5 ns (Ext trig in to pulse out)
Jitter:	± 15 ps (Ext trig in to pulse out)
DC offset ⁴ :	Apply required DC offset to back panel solder terminals (± 50 Volts, 250 mA max)
Trigger required:	External trigger mode: ECL-logic-level (LOW = -1.6V, HIGH = -0.8V) square wave with 50% duty cycle. The trigger input is terminated by 50 Ohms to -2V internally.
Sync output:	400 mV square wave, AC-coupled. Must be terminated with 50 Ohms to ground.
Monitor output:	Provides a -20 dB attenuated coincident replica of main output
Connectors:	Out, Monitor: SMA Trig, Sync: BNC
Optional accessory kit: (attenuators & terminators)	Add the suffix "-AK1" to the model number to include the recommended accessory kit. Consists of three SMA, 18 GHz, 2 Watt attenuators (10, 20 & 30 dB) for use on the output, and two 50 Ohm, 1 GHz, 1 Watt feed-through terminators (one SMA, one BNC) for use on external trigger inputs.
Optional accessory kit: (cables & adapters)	Add the suffix "-AK8" to the model number to include the recommended accessory kit. Consists of one 12-inch SMA-M/SMA-M PE-SR405FL coaxial cable, one 12-inch SMA-M/SMA-M RG-316 coaxial cable, one 36-inch SMA-M/SMA-M RG-316 coaxial cable, one 24-inch SMA-M/BNC-M RG-316 coaxial cable, one 36-inch BNC-M/BNC-M RG58C/U coaxial cable, one SMA-F to BNC-M adapter, one SMA-M to BNC-F adapter, one SMA-F to SMA-F adapter, and one SMA-F to solder cup adapter.
Power requirements:	100 - 240 Volts, 50 - 60 Hz
Dimensions:	(H x W x D) 100 x 430 x 375 mm, 3.9" x 17" x 14.8"
Chassis material:	Anodized aluminum, with blue plastic trim.
Temperature range:	+5°C to +40°C

- 1) -C suffix indicates stand-alone lab instrument with internal clock and line powering. (See <http://www.avtechpulse.com/formats> for details of the basic instrument formats).
- 2) For operation at amplitudes of less than 20% of full-scale, best results will be obtained by setting the amplitude near full-scale and using external attenuators on the output.
- 3) Indicate desired polarity by suffixing the model number with -P or -N (i.e. positive or negative) or -P-PN or -N-PN for dual polarity option where the suffix preceding -PN indicates the polarity at the mainframe output port.
- 4) For internally generated DC offset option (0 to ±5 V, one-turn control) add suffix -OT to the model number.
- 5) A 50 Ohm load is required. Other loads may damage the instrument. Consult Avtech (info@avtechpulse.com) if you need to drive other load impedances.

REGULATORY NOTES

FCC PART 18

This device complies with part 18 of the FCC rules for non-consumer industrial, scientific and medical (ISM) equipment.

This instrument is enclosed in a rugged metal chassis and uses a filtered power entry module (where applicable). The main output signal is provided on a shielded connector that is intended to be used with shielded coaxial cabling and a shielded load. Under these conditions, the interference potential of this instrument is low.

If interference is observed, check that appropriate well-shielded cabling is used on the output connectors. Contact Avtech (info@avtechpulse.com) for advice if you are unsure of the most appropriate cabling. Also, check that your load is adequately shielded. It may be necessary to enclose the load in a metal enclosure.

If any of the connectors on the instrument are unused, they should be covered with shielded metal "dust caps" to reduce the interference potential.

This instrument does not normally require regular maintenance to minimize interference potential. However, if loose hardware or connectors are noted, they should be tightened. Contact Avtech (info@avtechpulse.com) if you require assistance.

EC DECLARATION OF CONFORMITY



We Avtech Electrosystems Ltd.
 P.O. Box 5120, LCD Merivale
 Ottawa, Ontario
 Canada K2C 3H5

declare that this pulse generator meets the intent of Directive 2004/108/EG for Electromagnetic Compatibility. Compliance pertains to the following specifications as listed in the official Journal of the European Communities:

EN 50081-1 Emission

EN 50082-1 Immunity

and that this pulse generator meets the intent of the Low Voltage Directive 2006/95/EC. Compliance pertains to the following specifications as listed in the official Journal of the European Communities:

EN 61010-1:2001 Safety requirements for electrical equipment for measurement, control, and laboratory use

DIRECTIVE 2011/65/EU (RoHS)

We Avtech Electrosystems Ltd.
P.O. Box 5120, LCD Merivale
Ottawa, Ontario
Canada K2C 3H5

declare that, to the best of our knowledge, all electrical and electronic equipment (EEE) sold by the company are in compliance with Directive 2011/65/EU of the European Parliament and of the Council of 8 June 2011 on the restriction of the use of certain hazardous substances in electrical and electronic equipment (also known as “RoHS Recast”). In addition, this declaration of conformity is issued under the sole responsibility of Avtech Electrosystems Ltd. Specifically, products manufactured do not contain the substances listed in the table below in concentrations greater than the listed maximum value.

<i>Material/Substance</i>	<i>Threshold level</i>
Lead (Pb)	< 1000 ppm (0.1% by mass)
Mercury (Hg)	< 1000 ppm (0.1% by mass)
Hexavalent Chromium (Cr6+)	< 1000 ppm (0.1% by mass)
Polybrominated Biphenyls (PBB)	< 1000 ppm (0.1% by mass)
Polybrominated Diphenyl ethers (PBDE)	< 1000 ppm (0.1% by mass)
Cadmium (Cd)	< 100 ppm (0.01% by mass)

DIRECTIVE 2002/96/EC (WEEE)

European customers who have purchased this equipment directly from Avtech will have completed a “WEEE Responsibility Agreement” form, accepting responsibility for WEEE compliance (as mandated in Directive 2002/96/EC of the European Union and local laws) on behalf of the customer, as provided for under Article 9 of Directive 2002/96/EC.

Customers who have purchased Avtech equipment through local representatives should consult with the representative to determine who has responsibility for WEEE

compliance. Normally, such responsibilities will lie with the representative, unless other arrangements (under Article 9) have been made.

Requirements for WEEE compliance may include registration of products with local governments, reporting of recycling activities to local governments, and financing of recycling activities.

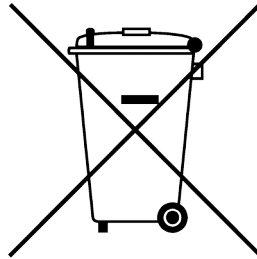

INSTALLATION

VISUAL CHECK

After unpacking the instrument, examine to ensure that it has not been damaged in shipment. Visually inspect all connectors, knobs, and handles. Confirm that a power cord is with the instrument. If the instrument has been damaged, file a claim immediately with the company that transported the instrument.

POWER RATINGS

This instrument is intended to operate from 100 - 240 V, 50 - 60 Hz.

The maximum power consumption is 90 Watts. Please see the “FUSES” section for information about the appropriate AC and DC fuses.

This instrument is an “Installation Category II” instrument, intended for operation from a normal single-phase supply.

CONNECTION TO THE POWER SUPPLY

An IEC-320 three-pronged recessed male socket is provided on the back panel for AC power connection to the instrument. One end of the detachable power cord that is supplied with the instrument plugs into this socket. The other end of the detachable power cord plugs into the local mains supply. Use only the cable supplied with the instrument. The mains supply must be earthed, and the cord used to connect the instrument to the mains supply must provide an earth connection. (The supplied cord does this.)

 Warning: Failure to use a grounded outlet may result in injury or death due to electric shock. This product uses a power cord with a ground connection. It must be connected to a properly grounded outlet. The instrument chassis is connected to the ground wire in the power cord.

The table below describes the power cord that is normally supplied with this instrument, depending on the destination region:

Destination Region	Description	Option	Manufacturer	Part Number
United Kingdom, Hong Kong, Singapore, Malaysia	BS 1363, 230V, 50 Hz	-AC00	Qualtek	370001-E01
Australia, New Zealand	AS 3112:2000, 230-240V, 50 Hz	-AC01	Qualtek	374003-A01
Continental Europe, Korea, Indonesia, Russia	European CEE 7/7 "Schuko" 230V, 50 Hz	-AC02	Qualtek	364002-D01
North America, Taiwan	NEMA 5-15, 120V, 60 Hz	-AC03	Qualtek	312007-01
Switzerland	SEV 1011, 230V, 50 Hz	-AC06	Qualtek	378001-E01
South Africa, India	SABS 164-1, 220-250V, 50 Hz	-AC17	Volex	2131H 10 C3
Japan	JIS 8303, 100V, 50-60 Hz	-AC18	Qualtek	397002-01
Israel	SI 32, 220V, 50 Hz	-AC19	Qualtek	398001-01
China	GB 1002-1, 220V, 50 Hz	-AC22	Volex	2137H 10 C3

PROTECTION FROM ELECTRIC SHOCK

 Operators of this instrument must be protected from electric shock at all times. The owner must ensure that operators are prevented access and/or are insulated from every connection point. In some cases, connections must be exposed to potential human contact. Operators must be trained to protect themselves from the risk of electric shock. This instrument is intended for use by qualified personnel who recognize shock hazards and are familiar with safety precautions required to avoid possibly injury. In particular, operators should:

1. Keep exposed high-voltage wiring to an absolute minimum.
2. Wherever possible, use shielded connectors and cabling.
3. Connect and disconnect loads and cables only when the instrument is turned off.
4. Keep in mind that all cables, connectors, oscilloscope probes, and loads must have an appropriate voltage rating.
5. Do not attempt any repairs on the instrument, beyond the fuse replacement procedures described in this manual. Contact Avtech technical support (see page 2 for contact information) if the instrument requires servicing. Service is to be performed solely by qualified service personnel.

ENVIRONMENTAL CONDITIONS

This instrument is intended for use under the following conditions:

1. indoor use;
2. altitude up to 2 000 m;
3. temperature 5 °C to 40 °C;
4. maximum relative humidity 80 % for temperatures up to 31 °C decreasing linearly to 50 % relative humidity at 40 °C;
5. Mains supply voltage fluctuations up to ± 10 % of the nominal voltage;
6. no pollution or only dry, non-conductive pollution.

FUSES

This instrument contains four fuses. All are accessible from the rear-panel. Two protect the AC prime power input, and two protect the internal DC power supplies. The locations of the fuses on the rear panel are shown in the figure below:

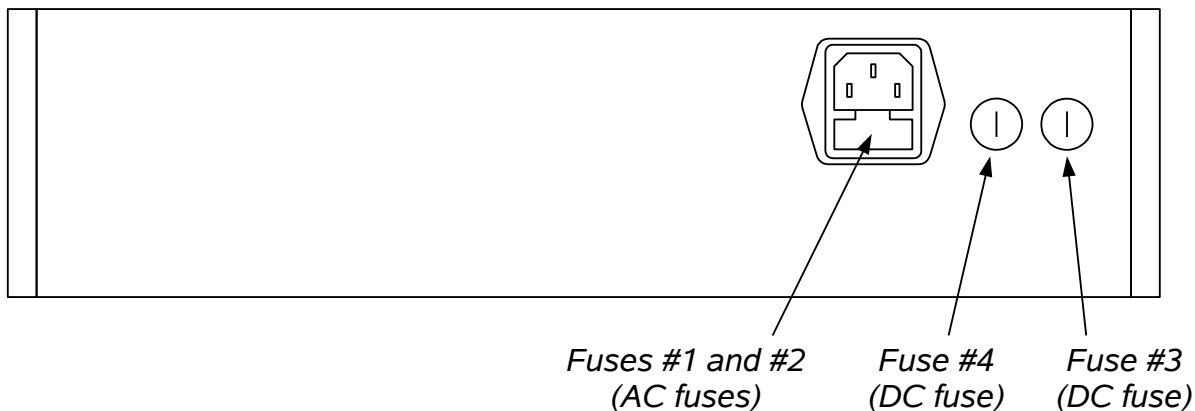

AC FUSE REPLACEMENT

To physically access the AC fuses, the power cord must be detached from the rear panel of the instrument. The fuse drawer may then be extracted using a small flat-head screwdriver, as shown below:



DC FUSE REPLACEMENT

The DC fuses may be replaced by inserting the tip of a flat-head screwdriver into the fuse holder slot, and rotating the slot counter-clockwise. The fuse and its carrier will then pop out.

FUSE RATINGS

The following table lists the required fuses:

Fuses	Nominal Mains Voltage	Rating	Case Size	Recommended Replacement Part	
				Littelfuse Part Number	Digi-Key Stock Number
#1, #2 (AC)	115 V	0.8A, 250V, Time-Delay	5×20 mm	0218.800HXP	F2418-ND
	230 V	0.5A, 250V, Time-Delay	5×20 mm	0218.500HXP	F2416-ND
#3 (DC)	N/A	2.5A, 250V, Time-Delay	5×20 mm	021802.5HXP	F2427-ND
#4 (DC)	N/A	2.0A, 250V, Time-Delay	5×20 mm	0218002.HXP	F2420-ND

The recommended fuse manufacturer is Littelfuse (<http://www.littelfuse.com>).

Replacement fuses may be easily obtained from Digi-Key (<http://www.digikey.com>) and other distributors.

FRONT PANEL CONTROLS

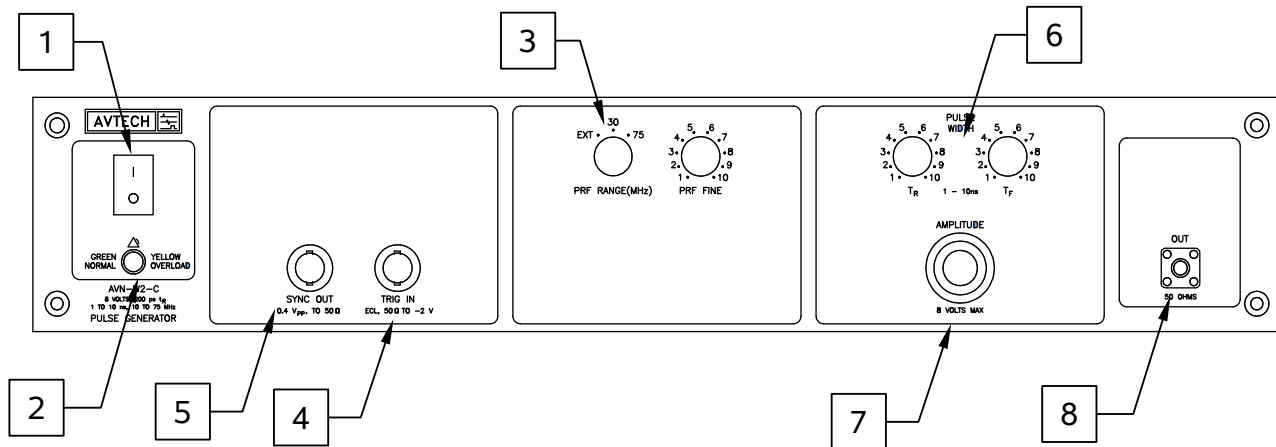

- 1) POWER Switch. This is the main power switch. When turning the instrument on, there may be a delay of several seconds before the instrument appears to respond.
- 2) OVERLOAD Indicator. When the instrument is powered, this indicator is normally green, indicating normal operation. If this indicator is yellow, an internal automatic overload protection circuit has been tripped. If the unit is overloaded (by operating at an exceedingly high duty cycle or by operating into a very low impedance), the protective circuit will disable the output of the instrument and turn the indicator light yellow. The light will stay yellow (i.e. output disabled) for about 5 seconds after which the instrument will attempt to re-enable the output (i.e. light green) for about 1 second. If the overload condition persists, the output will be disabled again (i.e. light yellow) for another 5 seconds. If the overload condition has been removed, the instrument will resume normal operation.

This overload indicator may flash yellow briefly at start-up. This is not a cause for concern.

- 3) PRF Range Switch. This switch sets the pulse repetition frequency (PRF) range of the internal oscillator. The marked value of each position is the upper limit of the 2:1 range, approximately. The vernier dial beside the switch varies the PRF within the set range.

If this switched is set to the "EXT" position, the instrument is triggered by a signal applied to the TRIG connector, rather than by the internal oscillator.

- 4) TRIG Connector. When the PRF Range Switch is set to "EXT", the instrument is triggered by an ECL-level (LOW = -1.6V, HIGH = -0.8V) square wave (50% duty cycle) applied to this connector. This input is terminated internally with 50 Ohms to -2V.

- 5) SYNC Connector. This output may be used to trigger oscilloscopes or other equipment. It is active in both the internal and external trigger modes. This output provides an AC-coupled 400 mV (peak-to-peak) square wave with the same pulse repetition frequency as the main output.
- 6) Pulse Width Control. These two one-turn controls vary the output pulse width and pulse shape. TR controls the leading edge of the pulse while TF controls the falling edge. Clockwise rotation of TR and TF increases the output pulse width. See the “General Operating Notes” section for more details.
- 7) Amplitude Control. This dial controls the amplitude.
- 8) OUT Connector. This SMA connector provides the main output to a 50 Ohm load.

Optional controls (not shown in the diagram):

OFFSET Control. (Present units with the -OT option only.) This controls the DC offset added to the output, in the range of -5V to +5V. The rear-panel OT On/Off switch must be in the “On” position for this function to be enabled.

REAR PANEL CONTROLS

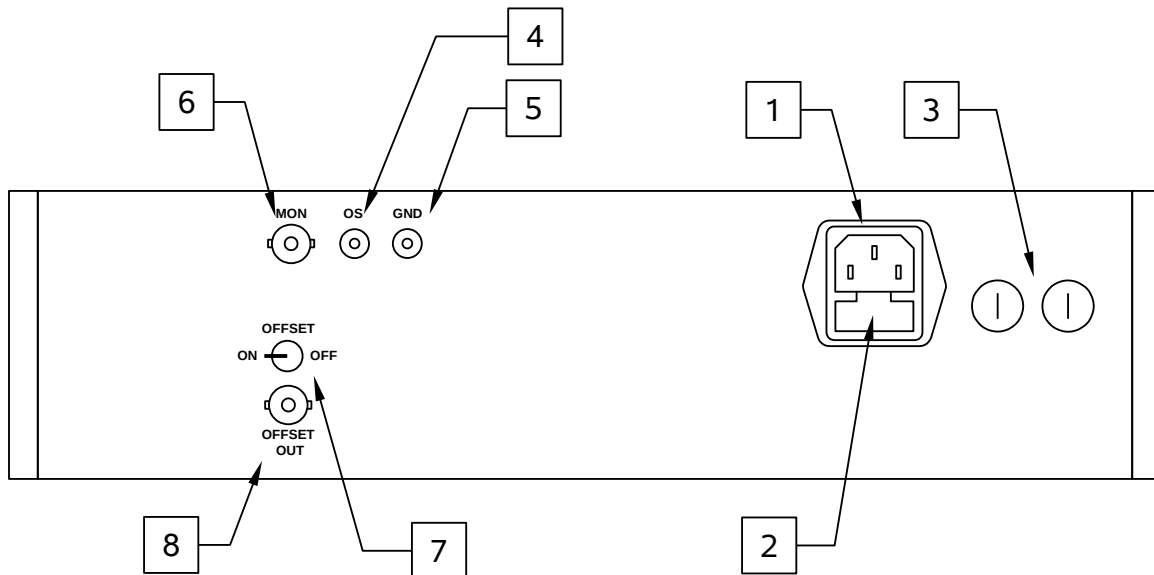

1. AC POWER INPUT. An IEC-320 C14 three-pronged recessed male socket is provided on the back panel for AC power connection to the instrument. One end of the detachable power cord that is supplied with the instrument plugs into this socket.
2. AC FUSE DRAWER. The two fuses that protect the AC input are located in this drawer. Please see the “FUSES” section of this manual for more information.
3. DC FUSES. These two fuses protect the internal DC power supplies. Please see the “FUSES” sections of this manual for more information.
4. OS INPUT CONNECTOR. (For units without the -OT option.) A DC offset in the range of $\pm 50\text{V}$ (250 mA max) may be applied to this solder terminal. The DC offset will appear on the output. When this feature is not used, the OS input should be connected to ground (using the adjacent GND connector). This is especially important when driving loads containing a diode.

When using an inverting transformer on the output, the DC offset should be applied to the transformer's offset input, and not this connector.

5. GND CONNECTOR. (For units without the -OT option.) This solder terminal is connected to ground. It may be used to ground the OS input connector.
6. M OUTPUT CONNECTOR. This SMA connector output provides a 20 dB attenuated coincident replica of main output, for monitoring purposes.

7. OT ON/OFF SWITCH. (Present on units with -OT option only.) This switch enables or disables the front-panel offset dial and the associated internal offset generation circuitry.
8. OT OUT CONNECTOR. (Present on units with -OT option only.) This BNC connector provides access to the internally-generated DC offset voltage when the OT ON/OFF switch is set to "ON".

To add an internally-generated offset to inverted pulses on AVN units with the dual polarity option (-PN), connect the "OFFSET OUT" BNC terminal to the DC terminal of the AVX-2-T inverting transformer (see the "POLARITY INVERSION" sections in this manual for further details).

GENERAL INFORMATION

BASIC TEST ARRANGEMENT

The AVN-W2-C should be tested with a sampling oscilloscope with a bandwidth of at least 15 GHz to properly observe the high-speed waveform. A typical test arrangement is shown below:

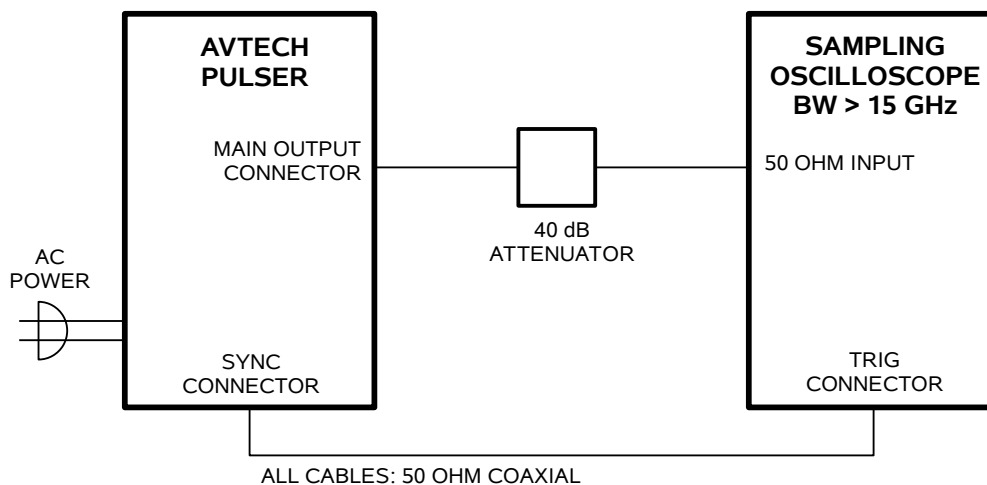

The attenuators are required to prevent damage to the sampling oscilloscope. A 40 dB attenuator with sufficient voltage rating should be used on the main output.

The SYNC output provides a 400 mV square wave (to 50 Ohms), and should be used to trigger the oscilloscope.

CONTROLLING THE PULSE SHAPE

The output pulse shape is determined by the two front panel controls TR and TF. TR controls the leading edge of the pulse while TF controls the falling edge. Clockwise rotation of TR and TF increases the output pulse width. Initially rotate the TF pot fully clockwise and set the TR pot at mid-range. The output amplitude is controlled by the front panel AMP control and by the input signal level. Initially the AMP control should be set maximum clockwise. The oscilloscope display will resemble the following:

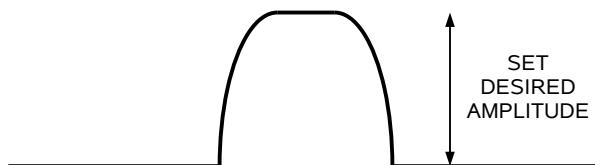

Having obtained a display of the form shown above, the desired pulse width is then obtained by adjusting the two front panel pots TR and TF. Rotate TR counter clockwise from the position set earlier until a sharp 100 ps leading edge is observed. Then rotate TF counterclockwise until the desired pulse width and fall time are obtained.

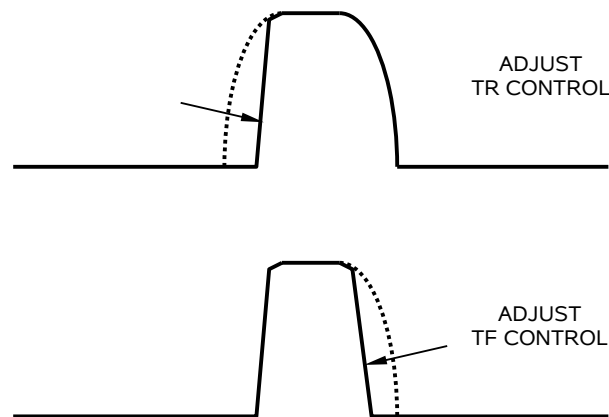

Further iterative adjustments of TR and TF will be necessary to simultaneously obtain the lowest rise time, lowest fall time, the desired pulse width, and pulse top shape, and low spurious signal level. In addition some additional adjustment of signal level may be necessary to obtain the desired amplitude. If the input frequency is then changed it will be necessary to readjust AMP, TR and TF to establish the required pulse shape.

To trigger externally, set the PRF Range Switch to "EXT". In this mode, the instrument is triggered by an ECL-level (LOW = -1.6V, HIGH = -0.8V) square wave (50% duty cycle) applied to the TRIG input connector. This input is terminated internally with 50 Ohms to -2V.

AMPLITUDE INTERACTION

Some properties of the output pulse will change as a function of the amplitude setting. For some demanding applications, it may be desirable to use a combination of external attenuators and the amplitude pot to achieve the desired output amplitude.

POLARITY INVERSION

Instruments with the "-P-PN" suffix generate up to +8V at the main output, and are supplied with an AVX-2 inverting transformer that can be installed on the mainframe output. A negative pulse is then obtained at the out port of the AVX-2 module.

Instruments with the "-N-PN" suffix generate up to -8V at the main output, and are supplied with an AVX-2 inverting transformer that can be installed on the mainframe output. A positive pulse is then obtained at the out port of the AVX-2 module.

When using the transformer with dual-polarity models, the external offset must be added to the DC terminal of the inverting transformer. Do not apply the offset to the rear-panel offset terminal on the mainframe. For units with the OT or EO options, connect a lead from the rear panel OS OUT connector to the DC terminal of the AVX-2-T unit. The DC offset at the output of the AVX-2-T unit is then controlled by the front-panel offset control.

OPERATION AT LOW AMPLITUDES

This instrument will generate the best waveforms when operated near maximum amplitude. If amplitudes less than 1/3 of the full-scale value are desired, better results will be obtained if the pulse generator is operated at a higher amplitude, and an attenuator is connected to the output. Avtech recommends the ATT-0527-XX-SMA-07 series of 12 GHz 20 Watt coaxial attenuators from Midwest Microwave, <http://www.midwestmicrowave.com/>. (The "XX" in the part number is replaced with the numeric attenuation value in dB).

OSCILLOSCOPE SELECTION AND BANDWIDTH ISSUES

To observe a signal with a rise time of t_R , the bandwidth of the oscilloscope must exceed $1/t_R$. For the AVN-W2-C, $1/t_R = 1 / 200 \text{ ps} = 5 \text{ GHz}$. For best results, the bandwidth of the oscilloscope (and any attenuators and cables used in the measurement system) should exceed 10 GHz.

Most oscilloscopes with suitable bandwidth are "sampling" oscilloscopes, which are more specialized in nature than slower conventional "real-time" oscilloscopes. Most sampling oscilloscopes have a very limited input voltage range ($\pm 1\text{V}$, for example). It is essential in these cases to use high-bandwidth attenuators on the input of the oscilloscope, to avoid over-driving or damaging the oscilloscope.

If a high-bandwidth sampling oscilloscope is not available, a slower real-time oscilloscope can be used, but the rising and falling edges will not be accurately displayed. Significant overshoot and ringing will be observed as a result of the oscilloscope's limited bandwidth. (Contrary to some user's expectations, low-bandwidth oscilloscopes *do not* "round off" the signal like a classic low-pass filter.) These are measurement artifacts, and are not normally present on the actual output.

MINIMIZING WAVEFORM DISTORTIONS

USE 50 OHM TRANSMISSION LINES AND LOADS

Connect the load to the pulse generator with 50 Ω transmission lines (e.g. RG-58 or RG-174 cable).

This instrument requires a 50 Ω load for proper operation. It will not properly drive a high-impedance load. The output stage will be damaged if it is operated into an open circuit (or any other high impedance). Failures due to improper output loading are not covered by the warranty.

USE LOW-INDUCTANCE LOADS

Lenz's Law predicts that for an inductive voltage spike will be generated when the current through an inductance changes. Specifically, $V_{\text{SPIKE}} = L \times dI_{\text{LOAD}}/dt$, where L is the inductance, I_{LOAD} is the load current change, and t is time. For this reason, it is important to keep any parasitic in the load low. This means keeping wiring short, and using low inductance components. In particular, wire-wound resistors should be avoided.

PREVENTING DAMAGE

The AVN-W2-C may fail if triggered at a PRF greater than 75 MHz, or less than 10 MHz.

This unit is designed to operate into a load impedance of 50 Ohms and the output stage will be damaged if it is operated into an open circuit (or any other high impedance). Failures due to improper output loading are not covered by the warranty.

The lifetime of the switching elements in the pulse generator module is proportional to the running time of the instrument. For this reason the prime power to the instrument should be turned off when the instrument is not in use.

OPTIONS

The AVN-W2-C is available with these options:

-OT OPTION

This option allows an internally generated DC offset to be added to the output. The output DC offset is variable from +5 to -5 Volts by means of the front-panel one-turn OFFSET control. The offset control may be turned off by means a the rear panel ON-OFF OFFSET switch.

-M OPTION

This option provides a monitor output, which is an attenuated replica of the main output. The monitor is connected to the main output through a 470 Ohm resistor, which results in an attenuation of approximately 20 dB (i.e., $\div 10$) when the monitor output is terminated with a 50 Ohm load.

The monitor output should be terminated with a 50 Ohm load.

MECHANICAL INFORMATION

TOP COVER REMOVAL

If necessary, the interior of the instrument may be accessed by removing the four Phillips screws on the top panel. With the four screws removed, the top cover may be slid back (and off).

 Always disconnect the power cord and allow the instrument to sit unpowered for 10 minutes before opening the instrument. This will allow any internal stored charge to discharge.

There are no user-adjustable internal circuits. For repairs other than fuse replacement, please contact Avtech (info@avtechpulse.com) to arrange for the instrument to be returned to the factory for repair. Service is to be performed solely by qualified service personnel.

 Caution: High voltages are present inside the instrument during normal operation. Do not operate the instrument with the cover removed.

RACK MOUNTING

A rack mounting kit is available. The -R5 rack mount kit may be installed after first removing the one Phillips screw on the side panel adjacent to the front handle.

ELECTROMAGNETIC INTERFERENCE

To prevent electromagnetic interference with other equipment, all used outputs should be connected to shielded loads using shielded coaxial cables. Unused outputs should be terminated with shielded coaxial terminators or with shielded coaxial dust caps, to prevent unintentional electromagnetic radiation. All cords and cables should be less than 3m in length.

MAINTENANCE

REGULAR MAINTENANCE

This instrument does not require any regular maintenance.

On occasion, one or more of the four rear-panel fuses may require replacement. All fuses can be accessed from the rear panel. See the “FUSES” section for details.

CLEANING

If desired, the interior of the instrument may be cleaned using compressed air to dislodge any accumulated dust. (See the “TOP COVER REMOVAL” section for instructions on accessing the interior.) No other cleaning is recommended.

WIRING DIAGRAMS

WIRING OF AC POWER

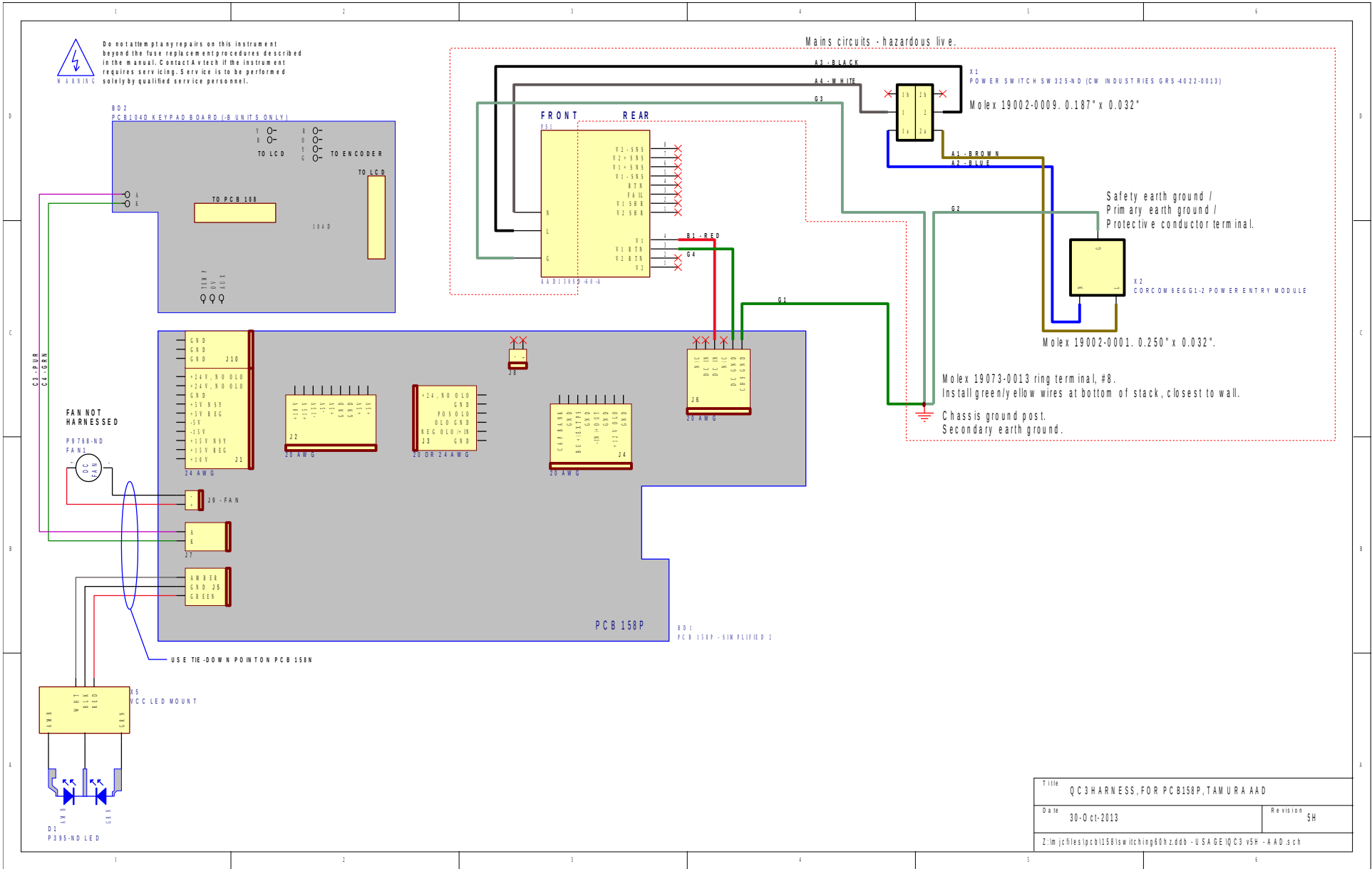

Title: QC3 HARNESS, FOR PCB158P, TAMURA AAD	
Date: 30-Oct-2013	Revision: 5H
Z:\m\jch\files\pcb158p\wiring\60hz.ddb - USA GE IQC3 v5H - AAD.sch	

PCB 158P - LOW VOLTAGE POWER SUPPLY, 1/3

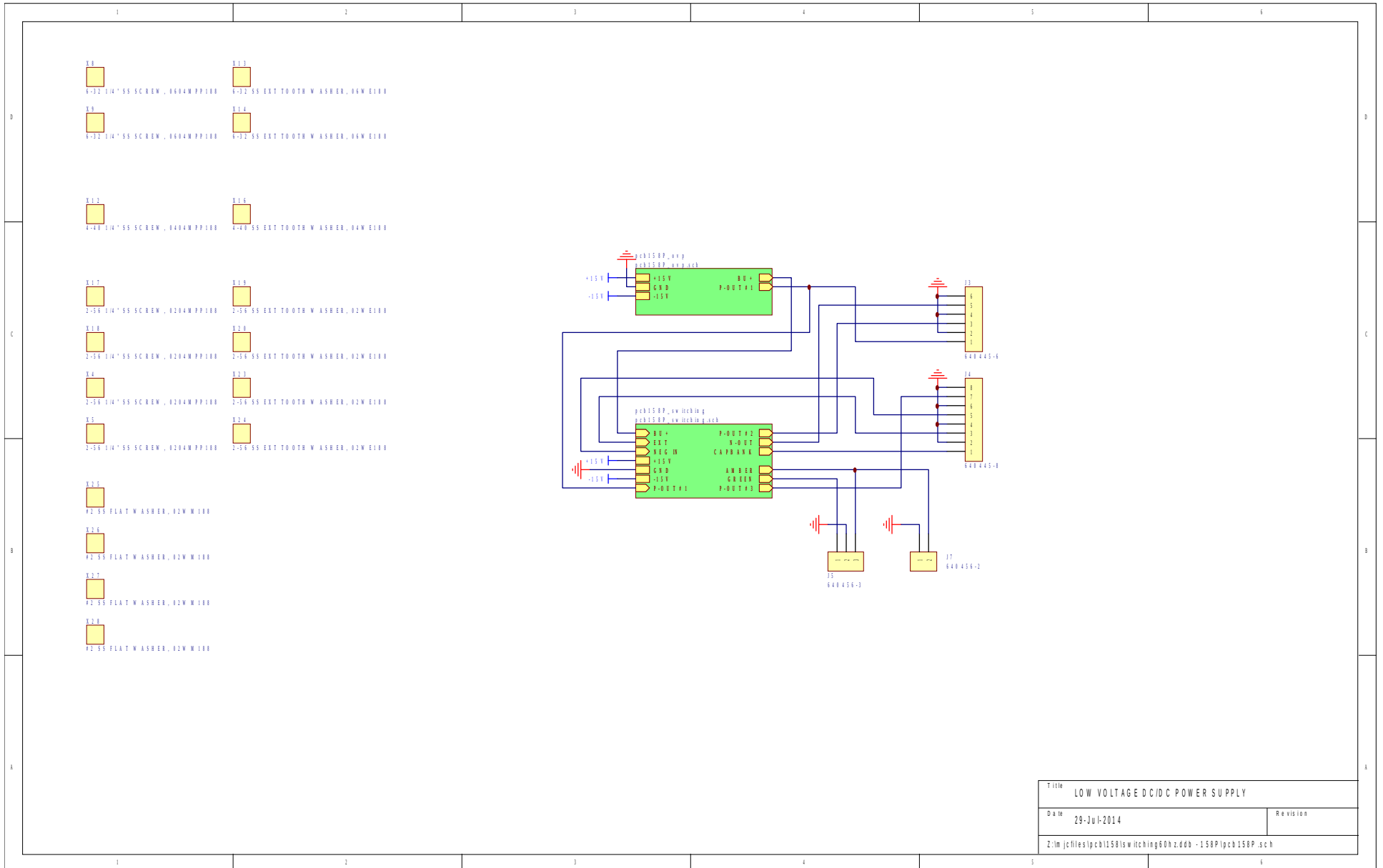

Title LOW VOLTAGE DC/DC POWER SUPPLY	
Date 20-JUL-2014	Revision
Z:\m\jcb\files\pcb158\sw\hchng60hz.ddd - 158P\pcb 158P.sch	

PCB 158P - LOW VOLTAGE POWER SUPPLY, 2/3

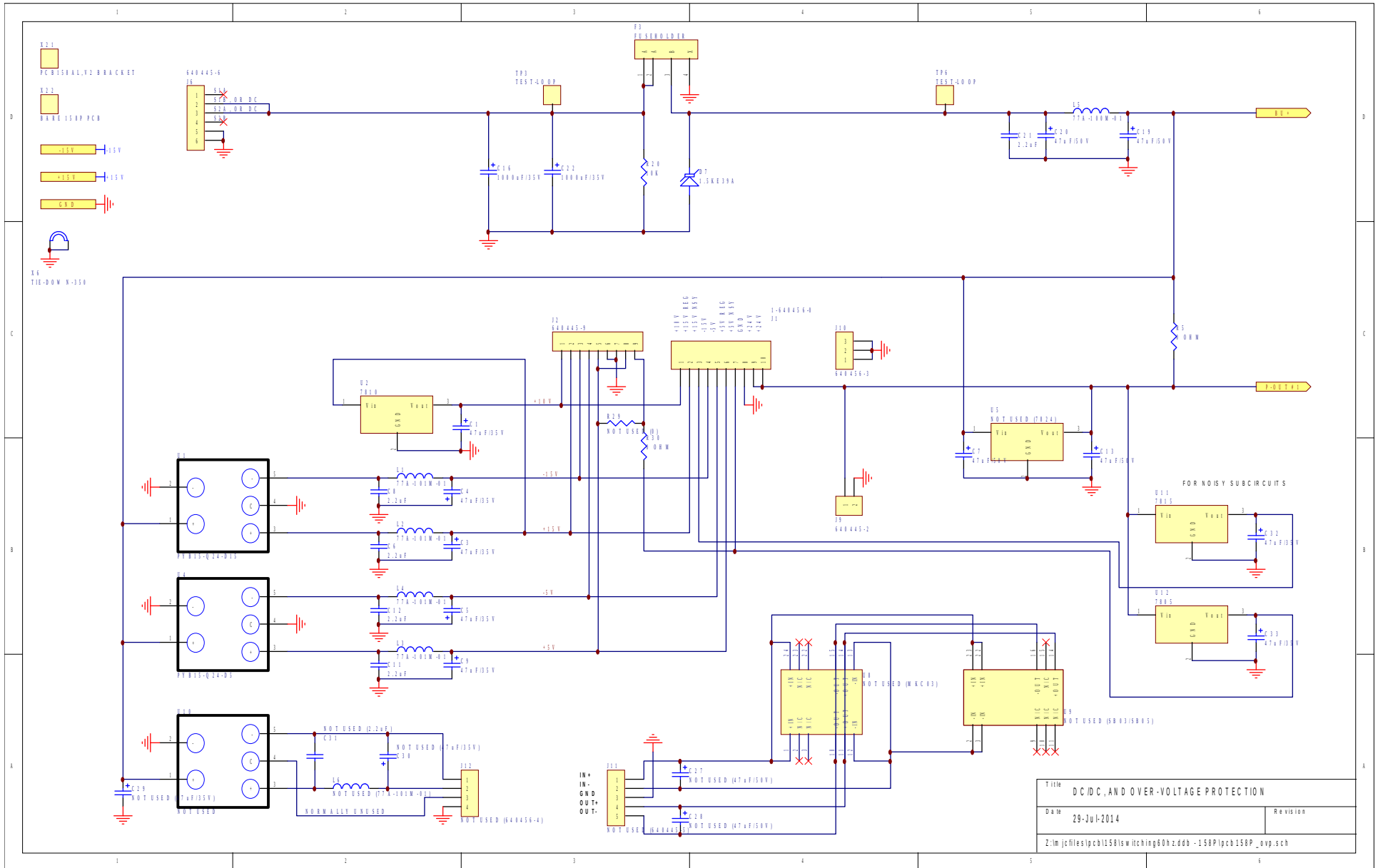

PCB 158P - LOW VOLTAGE POWER SUPPLY, 3/3

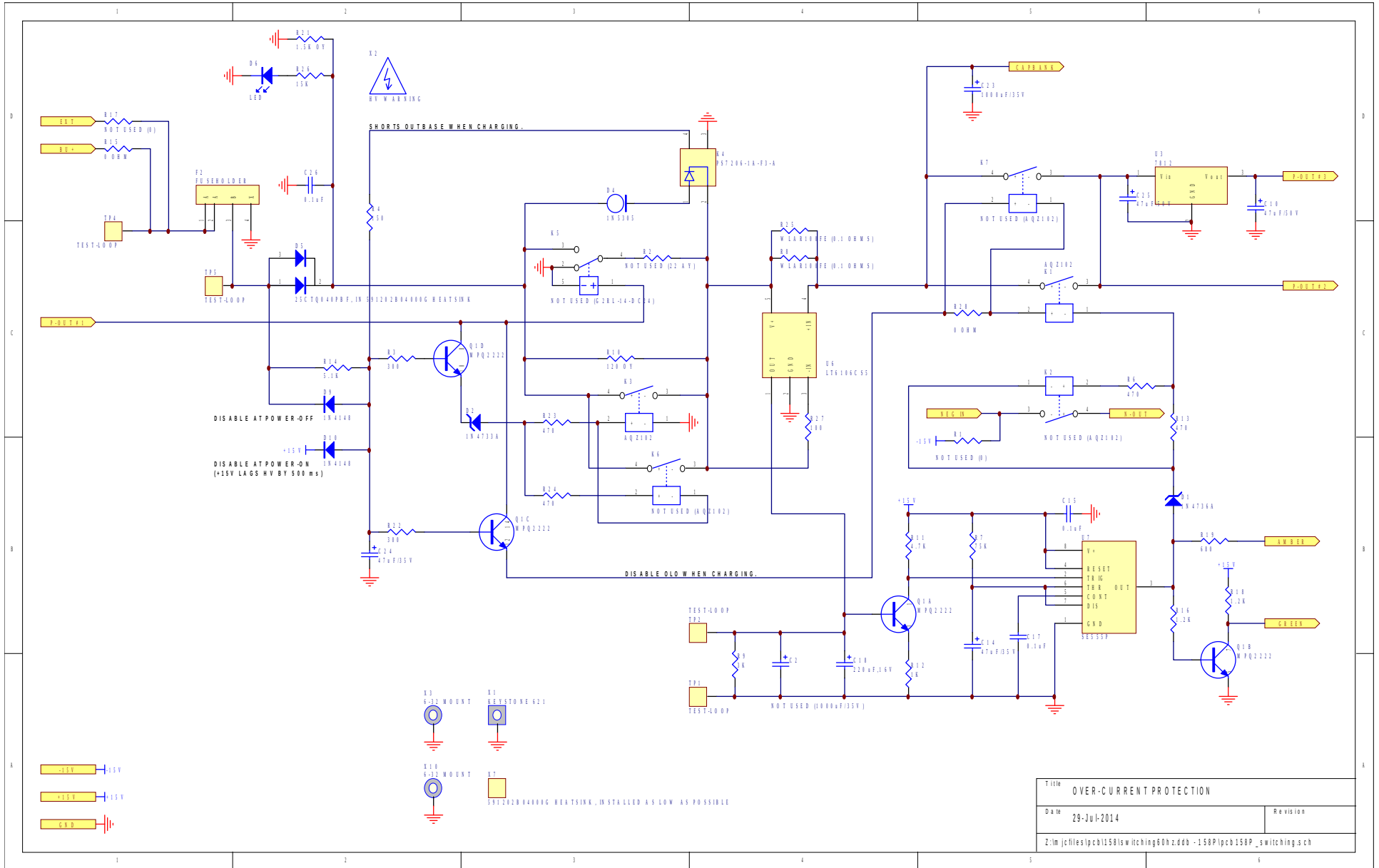

Title OVER-CURRENT PROTECTION	
Date 20-JUL-2014	Revision
Z:\lm\jctfiles\pcb158\switching60hz.ddd - 158P\pcb 158P_switching.sch	

PCB 231A - INTERNAL DC OFFSET FUNCTION

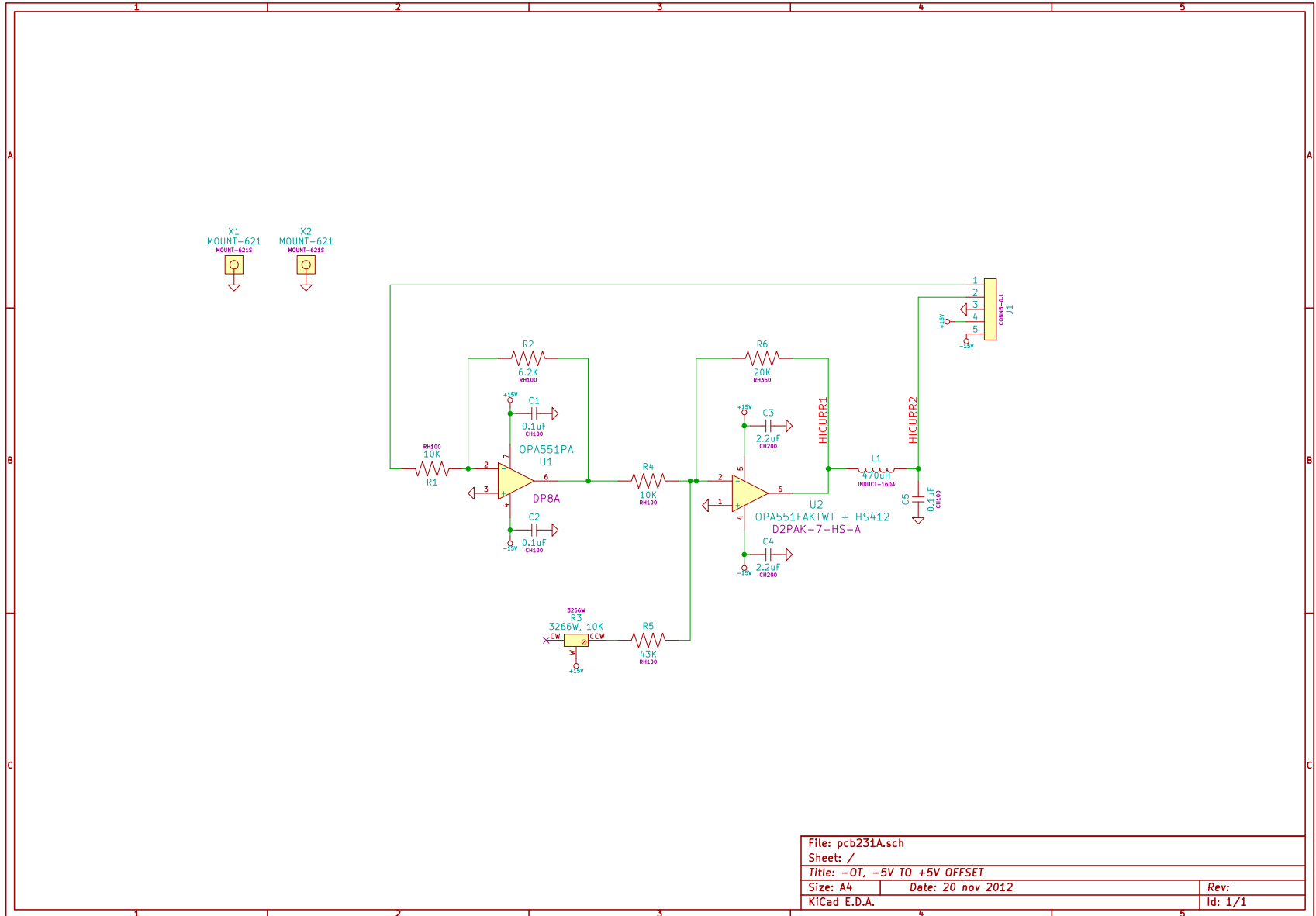

File: pcb231A.sch		Rev:	
Sheet: /		Id: 1/1	
Title: -0T, -5V TO +5V OFFSET			
Size: A4	Date: 20 nov 2012		
KiCad E.D.A.			

MAIN WIRING

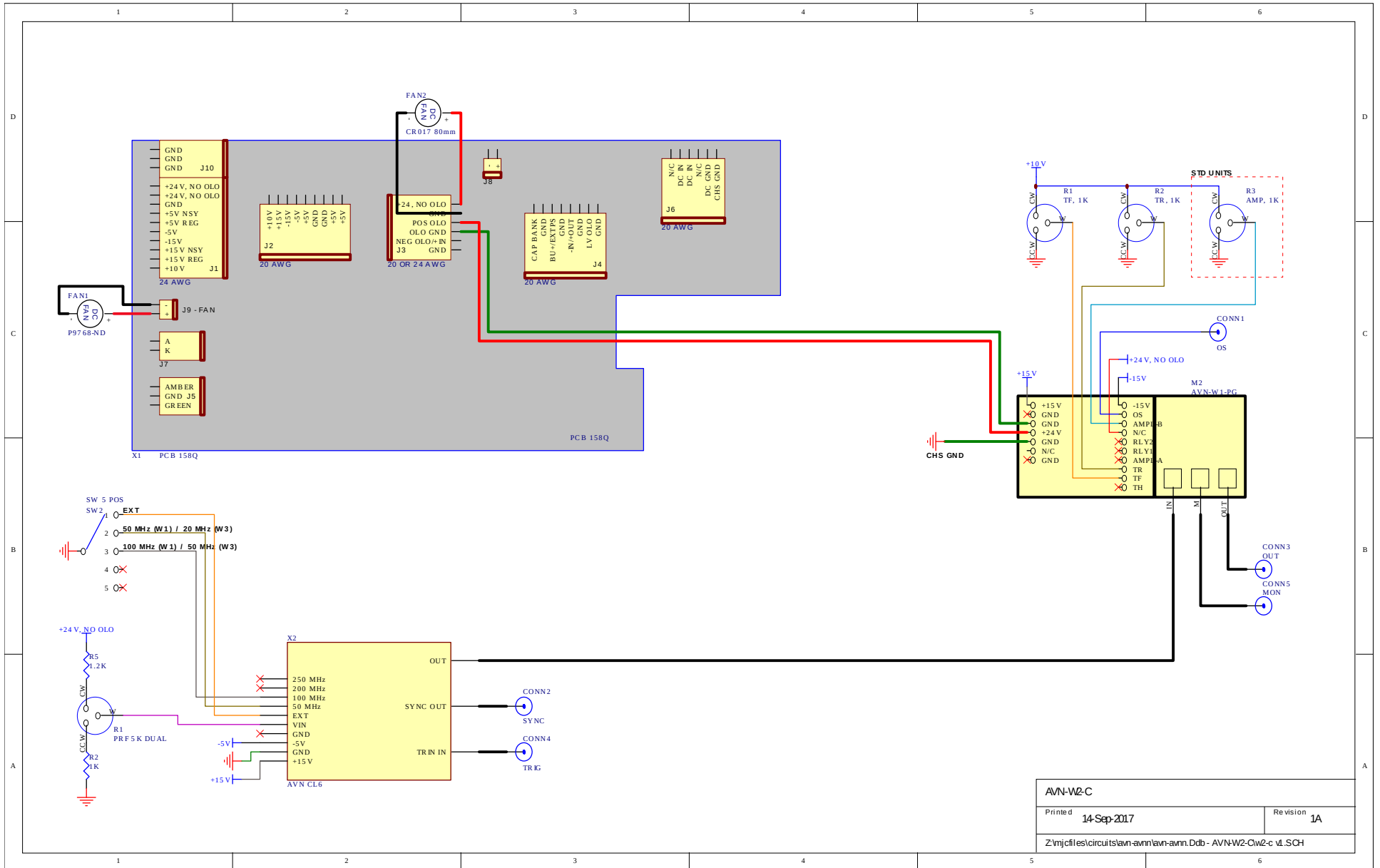

AVN-W2-C	
Printed 14-Sep-2017	Revision 1A
Z:\njc\files\circuits\lan-avn\lan-avn.Ddb - AVN-W2-Cw2-c.v1.SCH	

PERFORMANCE CHECK SHEET