

INSTRUCTIONS

MODEL AVOZ-A3-B

0 to 100 AMP, 0 to 100 V, 30 ns RISE TIME
LASER DIODE DRIVER
WITH IEEE 488.2 AND RS-232 CONTROL

SERIAL NUMBER: _____

WARRANTY

Avtech Electrosystems Ltd. warrants products of its manufacture to be free from defects in material and workmanship under conditions of normal use. If, within one year after delivery to the original owner, and after prepaid return by the original owner, this Avtech product is found to be defective, Avtech shall at its option repair or replace said defective item. This warranty does not apply to units which have been disassembled, modified or subjected to conditions exceeding the applicable specifications or ratings. This warranty is the extent of the obligation assumed by Avtech with respect to this product and no other warranty or guarantee is either expressed or implied.

TECHNICAL SUPPORT

Phone: 613-226-5772 or 1-800-265-6681

Fax: 613-226-2802 or 1-800-561-1970

E-mail: info@avtechpulse.com

World Wide Web: <http://www.avtechpulse.com>

TABLE OF CONTENTS

WARRANTY	2
TECHNICAL SUPPORT	2
TABLE OF CONTENTS	3
INTRODUCTION	5
SPECIFICATIONS	6
INSTALLATION	7
VISUAL CHECK	7
PLUGGING IN THE INSTRUMENT	7
LABVIEW DRIVERS	7
FRONT PANEL CONTROLS	8
REAR PANEL CONTROLS	10
GENERAL INFORMATION - PULSE GENERATOR TIMING	12
<hr/>	
BASIC PULSE CONTROL	12
TRIGGER MODES	13
GATING MODES	14
GENERAL INFORMATION - OPERATING INTO A LOAD	15
BASIC TEST ARRANGEMENT	15
CONNECTING THE LOAD	15
AMPLITUDE CONTROL	16
LENZ'S LAW AND INDUCTIVE VOLTAGE SPIKES	17
ATTACHING AND DETACHING LOADS	17
START-UP CHECK-LIST FOR LOCAL CONTROL	18
MECHANICAL INFORMATION	20
TOP COVER REMOVAL	20
RACK MOUNTING	20
CALIBRATION ADJUSTMENTS - SOFTWARE PROCEDURES	21
ADJUSTING AMPLITUDE ACCURACY	21
PROGRAMMING YOUR PULSE GENERATOR	22
KEY PROGRAMMING COMMANDS	22

ALL PROGRAMMING COMMANDS _____ **23**
PERFORMANCE CHECK SHEET _____ **25**

Manual Reference: /filesserver1/officefiles/instructword/avoz/AVOZ-A3-B.doc, created September 25, 2001

INTRODUCTION

The Model AVOZ-A3-B pulse generator is designed for pulsing laser diode and other low impedance loads with rectangular pulses as high as 100V into 1Ω (i.e. 100 Amps) with 30 ns rise and fall times. The current and voltage polarities depend on the model number:

"-P" units: 0 to +100 V amplitude (0 to +100 Amps)

"-N" units: 0 to -100 V amplitude (0 to -100 Amps)

"-PN" units: 0 to ± 100 V amplitude (0 to ± 100 Amps)

The pulse repetition frequency can vary from 1 Hz to 20 kHz, and pulse widths can vary from 50 ns to 2 μ s. The maximum duty cycle is 0.1%, and the maximum average output power is 10 Watts.

The Model AVOZ-A3-B pulse generator is a voltage pulser. The current amplitude is determined by Ohm's Law. That is, the current is the output voltage divided by the load resistance. The load resistance should be approximately 1Ω to attain a peak current of 100 A.

The loads can be connected to the pulse generator using the convenient LZ1 flexible flat transmission line, which has a 1Ω characteristic impedance (Z_0), and is terminated with a small circuit board.

The AVOZ-A3-B can be controlled from the front panel, or via a computer connected to the IEEE 488.2-compliant GPIB port, or the RS-232 serial port.

SPECIFICATIONS

Model:	AVOZ-A3-B
Amplitude:	
"-P" units:	0 to +100V into 1 Ω (0 to +100A)
"-N" units:	0 to -100V into 1 Ω (0 to -100A)
"-PN" units:	0 to \pm 100V into 1 Ω (0 to \pm 100A)
Pulse width:	50 ns to 2 μ s
Rise time:	\leq 30 ns
Fall time:	\leq 30 ns
PRF:	1 Hz to 20 kHz
Max. duty cycle:	0.1%
Output impedance:	\leq 0.05 Ohms
Propagation delay:	\leq 100 ns (Ext trig in to pulse out)
Jitter:	\pm 100 ps (Ext trig in to pulse out)
Trigger required: (external trigger mode)	Internal PW Mode: +5 Volt, 50 ns or wider (TTL)
Sync delay:	Sync out to pulse out: Variable 0 to \pm 2 us
Sync output:	+ 3 Volts, 200 ns, will drive 50 Ohm loads
Connectors:	Out: solder terminals on the end of 60 cm flexible microstrip Trig, Sync, Gate: BNC
Power, AC:	120/240 Volts (switchable) 50 - 60 Hz
Temperature range:	+ 10 $^{\circ}$ to + 40 $^{\circ}$ C

INSTALLATION

VISUAL CHECK

After unpacking the instrument, examine to ensure that it has not been damaged in shipment. Visually inspect all connectors, knobs, liquid crystal displays (LCDs), and the handles. Confirm that a power cord, a GPIB cable, a LZ1 flexible transmission line, and two instrumentation manuals (this manual and the "OP1B Interface Programming Manual") are with the instrument. If the instrument has been damaged, file a claim immediately with the company that transported the instrument.

PLUGGING IN THE INSTRUMENT

Examine the rear of the instrument. There will be a male power receptacle, a fuse holder and the edge of the power selector card visible. Confirm that the power selector card is in the correct orientation.

For AC line voltages of 110-120V, the power selector card should be installed so that the "120" marking is visible from the rear of the instrument.

For AC line voltages of 220-240V, the power selector card should be installed so that the "240" marking is visible from the rear of the instrument.

If it is not set for the proper voltage, remove the fuse and then grasp the card with a pair of pliers and remove it. Rotate horizontally through 180 degrees. Reinstall the card and the correct fuse.

In the 120V setting, a 1.0A slow blow fuse is required. In the 240V setting, a 0.5A slow blow fuse is required.

LABVIEW DRIVERS

A LabVIEW driver for this instrument is available for download at the Avtech web site, at <http://www.avtechpulse.com/labview>. A copy is also available in National Instruments' Instrument Driver Library at <http://www.natinst.com/>.

FRONT PANEL CONTROLS

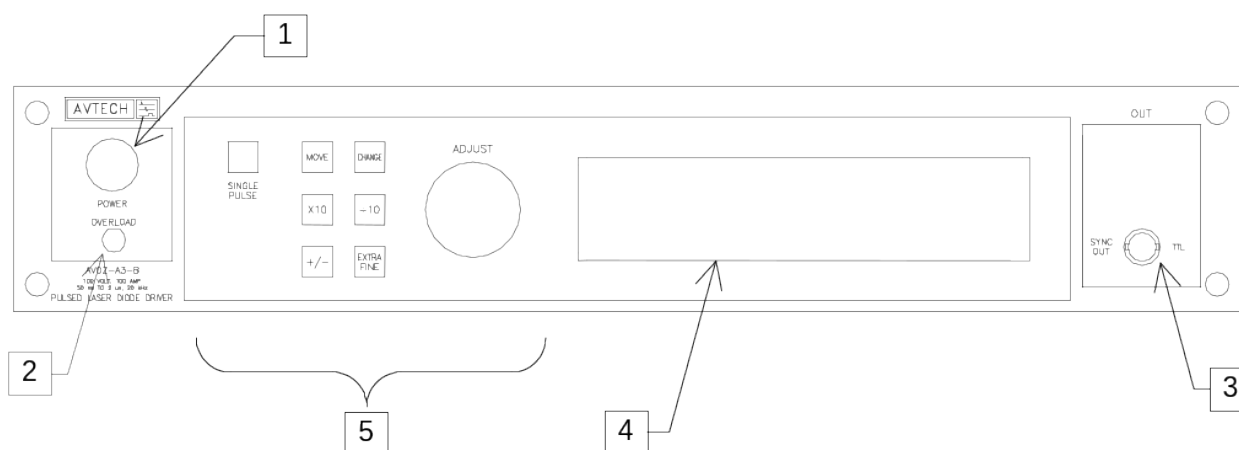

1. **POWER Switch.** The POWER push button switch applies AC prime power to the primaries of the transformer, turning the instrument on. The push button lamp (#382 type) is connected to the +15V DC supply.
2. **OVERLOAD.** This instrument is protected in its internal software against conflicting or dangerous settings. As an additional protective measure, an automatic overload circuit exists, which controls the front panel overload light. If the unit is overloaded (for instance, by operating at an exceedingly high duty cycle or by operating into a very low impedance), the protective circuit will turn the output of the instrument OFF and turn the indicator light ON. The light will stay ON (i.e. output OFF) for about 5 seconds after which the instrument will attempt to turn ON (i.e. light OFF) for about 1 second. If the overload condition persists, the instrument will turn OFF again (i.e. light ON) for another 5 seconds. If the overload condition has been removed, the instrument will turn on and resume normal operation.

This overload indicator may come on briefly at start-up. This is not a cause for concern.

3. **SYNC OUT.** This connector supplies a SYNC output that can be used to trigger other equipment, particularly oscilloscopes. This signal leads, or lags, the main output by a duration set by the "DELAY" controls and has an approximate amplitude of +3 Volts to $R_L > 1k\Omega$ with a pulse width of approximately 200 ns.
4. **LIQUID CRYSTAL DISPLAY (LCD).** This LCD is used in conjunction with the keypad to change the instrument settings. Normally, the main menu is displayed, which lists the key adjustable parameters and their current values. The "OP1B Interface Programming Manual" describes the menus and submenus in detail.

5. KEYPAD.

Control Name	Function
MOVE	This moves the arrow pointer on the display.
CHANGE	This is used to enter the submenu, or to select the operating mode, pointed to by the arrow pointer.
×10	If one of the adjustable numeric parameters is displayed, this increases the setting by a factor of ten.
÷10	If one of the adjustable numeric parameters is displayed, this decreases the setting by a factor of ten.
+/-	If one of the adjustable numeric parameters is displayed, and this parameter can be both positive or negative, this changes the sign of the parameter.
EXTRA FINE	This changes the step size of the ADJUST knob. In the extra-fine mode, the step size is twenty times finer than in the normal mode. This button switches between the two step sizes.
ADJUST	This large knob adjusts the value of any displayed numeric adjustable values, such as frequency, pulse width, etc. The adjust step size is set by the "EXTRA FINE" button. When the main menu is displayed, this knob can be used to move the arrow pointer.

REAR PANEL CONTROLS

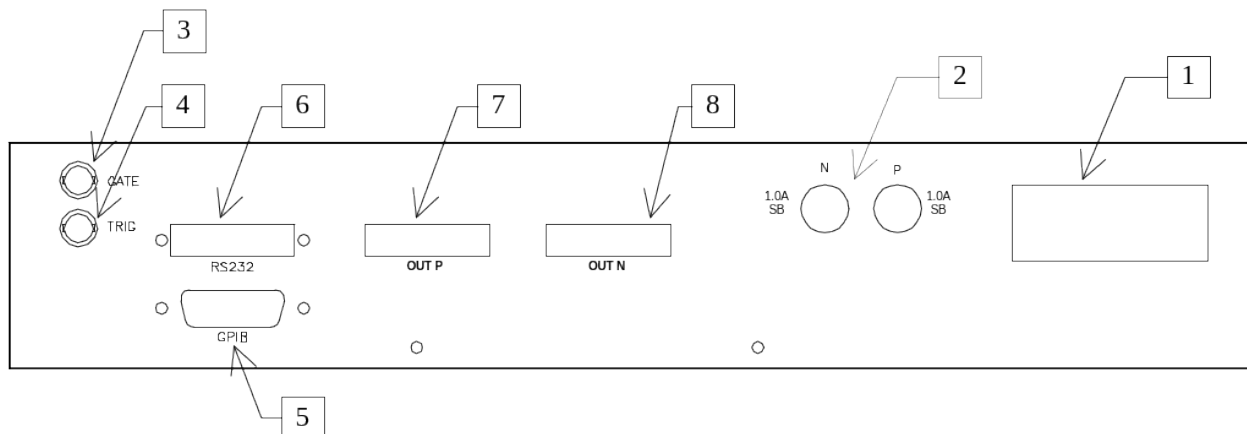

1. **AC POWER INPUT.** A three-pronged recessed male connector is provided on the back panel for AC power connection to the instrument. Also contained in this assembly is a slow-blow fuse and a removable card that can be removed and repositioned to switch between 120V AC in and 240V AC in.

For AC line voltages of 110-120V, the power selector card should be installed so that the “120” marking is visible from the rear of the instrument.

For AC line voltages of 220-240V, the power selector card should be installed so that the “240” marking is visible from the rear of the instrument.

If it is not set for the proper voltage, remove the fuse and then grasp the card with a pair of pliers and remove it. Rotate horizontally through 180 degrees. Reinstall the card and the correct fuse.

In the 120V setting, a 1.0A slow blow fuse is required. In the 240V setting, a 0.5A slow blow fuse is required.

2. **DC FUSE.** These slow-blow fuses protect the internal DC power supplies.
3. **GATE.** This TTL-level (0 and +5V) logic input can be used to gate the triggering of the instrument. This input can be either active high or active low, depending on the front panel settings or programming commands. (The instrument triggers normally when this input is unconnected).
4. **TRIG.** This TTL-level (0 and +5V) logic input can be used to trigger the instrument, if the instrument is set to triggering externally. The instrument triggers on the rising edge of this input.
5. **GPIB Connector.** A standard GPIB cable can be attached to this connector to allow the instrument to be computer-controlled. See the “OP1B Interface Programming

Manual” for more details on GPIB control.

6. RS-232 Connector. A standard serial cable with a 25-pin male connector can be attached to this connector to allow the instrument to be computer-controlled. See the “OP1B Interface Programming Manual” for more details on RS-232 control.
7. OUT P. This is the main positive output, present on “-P” and “-PN” units. The LZ1 transmission line or the RG174 transmission line plugs into this socket. The upper side of the socket (“UP”) is the signal line. The lower side (“DOWN”) is connected to ground.
8. OUT N. This is the main negative output, present on “-N” and “-PN” units. The LZ1 transmission line or the RG174 transmission line plugs into this socket. The upper side of the socket (“UP”) is the signal line. The lower side (“DOWN”) is connected to ground.

GENERAL INFORMATION - PULSE GENERATOR TIMING

BASIC PULSE CONTROL

This instrument can be triggered by its own internal clock or by an external TTL trigger signal. In either case, two output channels respond to the trigger: OUT and SYNC. The OUT channel is the signal that is applied to the device under test. Its amplitude and pulse width are variable. The SYNC pulse is a fixed-width TTL-level reference pulse used to trigger oscilloscopes or other measurement systems. When the delay is set to a positive value the SYNC pulse precedes the OUT pulse.

In the diagrams below, positive amplitude is assumed. (For “-N” units, the output waveforms are inverted in polarity.)

These pulses are illustrated below for a positive delay, and internal triggering:

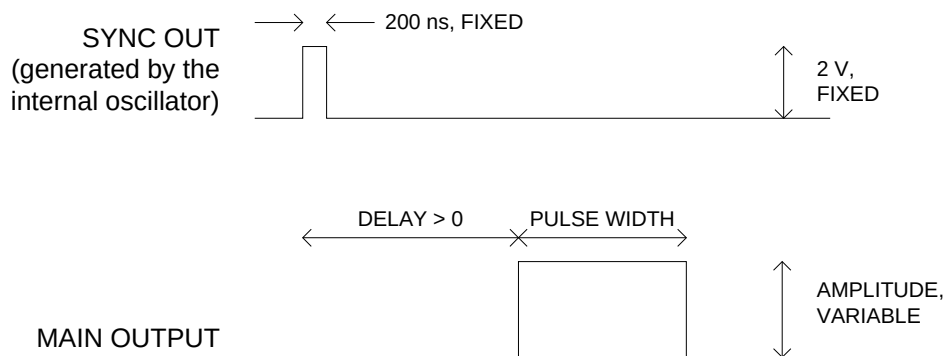

Basic Output Pulses for Delay > 0

The order of the output pulses is reversed for negative delays:

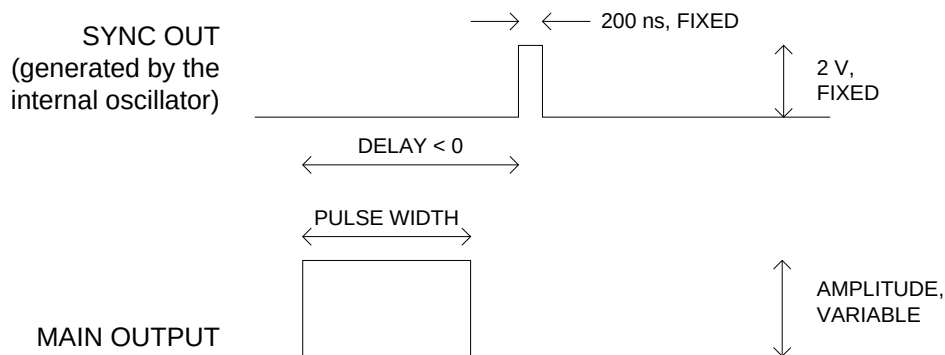

Basic Output Pulses for Delay < 0

When the triggering is set to external mode, a TTL-level pulse on the TRIG input will trigger the pulse generator, as shown below:

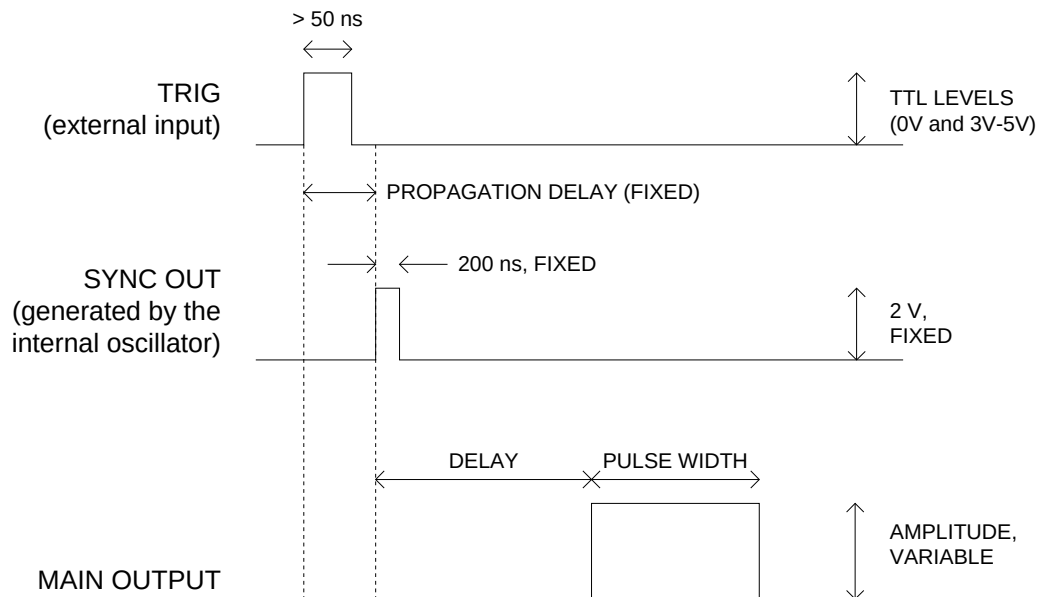

As before, if the delay is negative, the order of the SYNC and OUT pulses is reversed.

TRIGGER MODES

This instrument has four trigger modes:

- Internal Trigger: the instrument controls the trigger frequency, and generates the clock internally.
- External Trigger: the instrument is triggered by an external TTL-level clock on the back-panel TRIG connector.
- Manual Trigger: the instrument is triggered by the front-panel "SINGLE PULSE" pushbutton.
- Hold Trigger: the instrument is set to not trigger at all.

These modes can be selected using the front panel trigger menu, or by using the appropriate programming commands. (See the "OP1B Interface Programming Manual" for more details.)

GATING MODES

Triggering can be suppressed by a TTL-level signal on the rear-panel GATE connector. The instrument can be set to stop triggering when this input high or low, using the front-panel gate menu or the appropriate programming commands. This input can also be set to act synchronously or asynchronously. When set to asynchronous mode, the GATE will disable the output immediately. Output pulses may be truncated. When set to synchronous mode, the output will complete the full pulse width if the output is high, and then stop triggering. No pulses are truncated in this mode.

GENERAL INFORMATION - OPERATING INTO A LOAD

BASIC TEST ARRANGEMENT

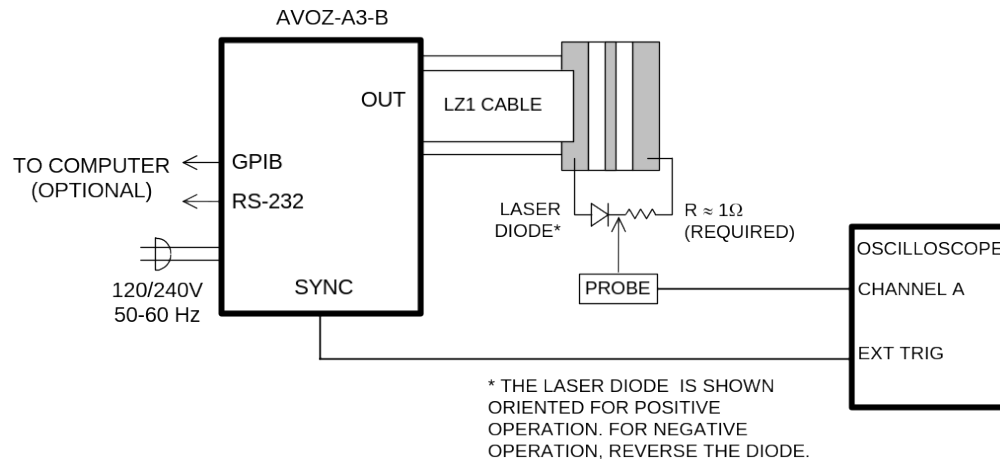

The equipment should be connected in the general fashion shown above. Since the AVOZ unit provides an output pulse rise time as low as 30 ns a fast oscilloscope (at least 100 MHz) should be used to display the waveform.

Proper choice of test resistance is important. It is essential that the resistive test load be low-inductance. (Wirewound resistors are not acceptable, unless many are connected together in parallel.) The power dissipated in the resistor is given by

$$P_{\text{AVERAGE}} = I^2 \times R \times \frac{\text{PW}}{T}, \quad P_{\text{PEAK}} = I^2 \times R$$

where “I” is the current, “R” is the resistance, “PW” is the pulse width, and “T” is the pulse period (1/frequency). The power rating of the resistance should exceed this average power rating by a large margin. Beware that some low-value resistors exhibit a significant temperature-dependence, even when the average power dissipated is below the resistor’s power rating. This is particularly true if the peak power exceeds the resistor’s power rating.

CONNECTING THE LOAD

The loads can be connected to the LZ1 flexible flat transmission line, which has a 1Ω characteristic impedance (Z_0), and is terminated with a small circuit board.

The diode load and a non-inductive load resistor should be solder connected to the end of the line as shown below (using extremely short lead lengths (eg. 0.2 cm) so as to

reduce inductance). The series combination of the laser diode and the load resistor R_L should present 1Ω to the end of the line. The instrument generates up to 100 Volts to provide a peak load current of 100 Amperes. For many diodes, a load resistor 1Ω may be selected as a first choice. An ultra fast rectifier diode may be placed across the laser diode to protect against reverse transients. Note that the net load resistance may be higher than 1Ω but in this case the peak current will be less than 100 Amperes.

The end of the LZ1 line is illustrated below:

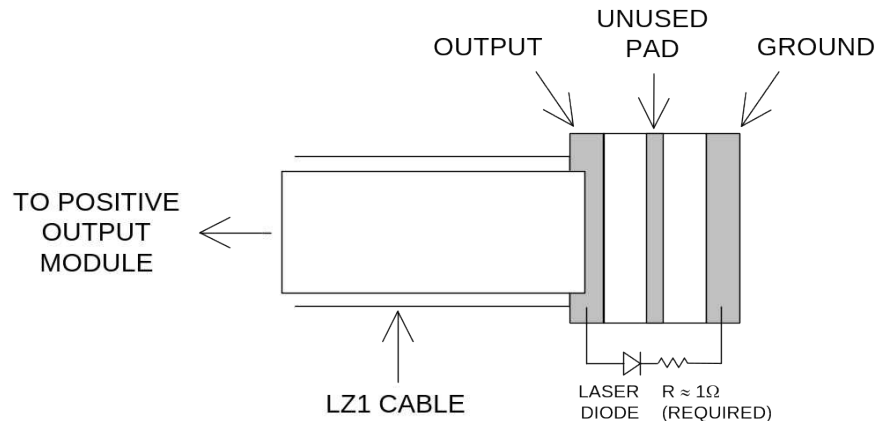

In the above diagram, the diode is oriented for positive current flow. Reverse the diode for negative operation.

The next diagram shows how ultrafast rectifier diodes may be added to protect the laser diode:

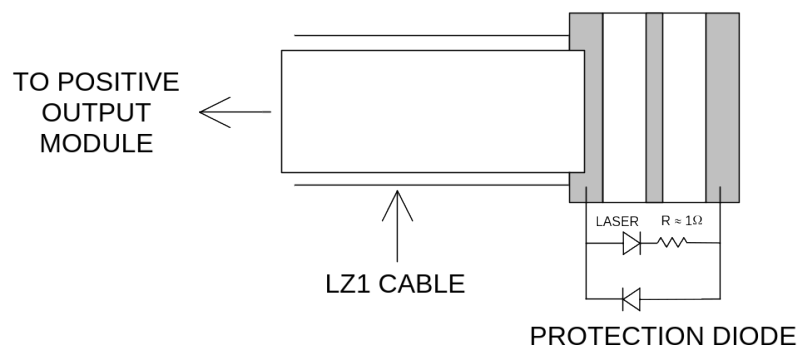

Again, in the above diagram, the diodes are oriented for positive current flow. Reverse all diodes for negative operation.

AMPLITUDE CONTROL

The Model AVOZ-A3-B pulse generator is a voltage pulser. The current amplitude is determined by Ohm's Law. That is, the current is the output voltage divided by the load resistance.

More specifically,
$$I_{OUT} = \frac{V_{SETTING} - V_{DIODE}}{R},$$

where $V_{SETTING}$ is the set amplitude, V_{DIODE} is the diode voltage, and R is the series resistance (including any series resistance in the diode itself). R is normally 1Ω ; it should not be smaller than this.

LENZ'S LAW AND INDUCTIVE VOLTAGE SPIKES

This instrument is designed to pulse resistive and diode loads and will exhibit a large output spike when used to drive a load with significant inductance (as predicted by LENZ'S LAW). For this reason the load should be connected to the output using low inductance leads (as short as possible and as heavy a gauge as possible).

The voltage developed across an inductance L (in Henries), when the current is changing at a rate given by di_{LOAD}/dt (in Amps/sec), is:
$$V_{SPIKE} = L \frac{di_{LOAD}}{dt}.$$

ATTACHING AND DETACHING LOADS

To avoid damaging the loads connected to main outputs, the loads should only be connected to or removed from the instrument when the instrument is off. Do not connect loads when the instrument is on and the output amplitude is not zero. This can cause sparking.

START-UP CHECK-LIST FOR LOCAL CONTROL

- 1) Insert a 1Ω test load between the signal out and ground pads on the LZ1 circuit board.
- 2) Connect a cable from the SYNC OUT connector to the TRIG input of an oscilloscope. Set the oscilloscope to trigger externally.
- 3) Connect an oscilloscope probe to the signal side of the test load. On the oscilloscope, set the channel A vertical scale to 20 V/div, and the horizontal scale to 100 ns/div.
- 4) Turn on the instrument. The main menu will appear on the LCD.
- 5) To set the instrument to trigger from the internal clock at a PRF of 1 kHz:
 - The arrow pointer should be pointing at the frequency menu item. If it is not, press the MOVE button until it is.
 - Press the CHANGE button. The frequency submenu will appear. Rotate the ADJUST knob until the frequency is set at 1 kHz.
 - The arrow pointer should be pointing at the “Internal” choice. If it is not, press MOVE until it is.
 - Press CHANGE to return to the main menu.
- 6) To set the delay to 100 ns:
 - Press the MOVE button until the arrow pointer is pointing at the delay menu item.
 - Press the CHANGE button. The delay submenu will appear. Rotate the ADJUST knob until the delay is set at 100 ns.
 - Press CHANGE to return to the main menu.
- 7) To set the OUT pulse width to 500 ns:
 - Press the MOVE button until the arrow pointer is pointing at the “PW” menu item.
 - Press the CHANGE button. The pulse width submenu will appear. Rotate the ADJUST knob until the pulse width is set at 500 ns.

- The arrow pointer should be pointing at the “Normal” choice. If it is not, press MOVE until it is.
 - Press CHANGE to return to the main menu.
- 8) At this point, nothing should appear on the oscilloscope.
- 9) To enable the output:
- Press the MOVE button until the arrow pointer is pointing at the output menu item.
 - Press the CHANGE button. The output submenu will appear.
 - Press MOVE until the arrow pointer is pointing at the “ON” choice.
 - Press CHANGE to return to the main menu.
- 10) To change the OUT output amplitude:
- Press the MOVE button until the arrow pointer is pointing at the AMP menu item.
 - Press the CHANGE button. The amplitude submenu will appear. Rotate the ADJUST knob until the amplitude is set at 100 V (or -100V for “-N” units).
 - Observe the oscilloscope. You should see 500 ns wide, 100V pulses on the probe connected to the main output.
 - Press CHANGE to return to the main menu.
- 11) Try varying the pulse width, by repeating step (7). As you rotate the ADJUST knob, the pulse width on the oscilloscope will change. It should agree with the displayed value.
- 12) This completes the operational check.

If additional assistance is required:

Tel: (613) 226-5772,
Fax: (613) 226-2802
Email: info@avtechpulse.com

MECHANICAL INFORMATION

TOP COVER REMOVAL

The top cover of the instrument may be removed by removing the four Phillips screws on the top panel. With these four screws removed, the top panel may be slid off by pulling it towards the rear.

RACK MOUNTING

A rack mounting kit is available. The -R5 rack mount kit may be installed after first removing the one Phillips screw on the side panel adjacent to the front handle.

CALIBRATION ADJUSTMENTS - SOFTWARE PROCEDURES

ADJUSTING AMPLITUDE ACCURACY

If it is found that the output amplitude settings (as set by the front-panel controls or programming commands) do not agree exactly with measured values of amplitude (i.e., by examining the output on an oscilloscope), the amplitude calibration can be updated using software commands.

The following procedure is suggested:

- 1) Connect a 1 Ω high-power resistive load to the output.
- 2) Connect the pulse generator to a computer using the GPIB or RS232 ports.
- 3) Turn on the pulse generator, and set the time controls (frequency, delay, pulse width) to typical values.
- 4) Turn on the outputs.
- 5) Set the output amplitude to 100V.
- 6) Observe the voltage across the load. (For example, suppose it is 104V).
- 7) Send the measured value to the instrument using the following command:

```
diag:ampl:cal 104
```

The internal software compares the supplied measured value to the programmed value, and adjusts the internal calibration data to null out any differences.

- 8) Observe the voltage across the load again. The amplitude setting should now agree with the measured value.

Information on more extensive timing and amplitude calibration procedures is available at <http://www.avtechpulse.com/appnote/>.

PROGRAMMING YOUR PULSE GENERATOR

KEY PROGRAMMING COMMANDS

The “OP1B Interface Programming Manual” describes in detail how to connect the pulse generator to your computer, and the programming commands themselves. A large number of commands are available; however, normally you will only need a few of these. Here is a basic sample sequence of commands that might be sent to the instrument after power-up:

```
*rst                (resets the instrument)
trigger:source internal (selects internal triggering)
frequency 10 Hz      (sets the frequency to 10 Hz)
pulse:width 100 ns   (sets the pulse width to 100 ns)
pulse:delay 1 us     (sets the delay to 1 us)
output on            (turns on the output)
source:volt 50V      (sets the voltage amplitude to 50 Volts)
```

For triggering a single event, this sequence would be more appropriate:

```
*rst                (resets the instrument)
trigger:source hold  (turns off all triggering)
pulse:width 100 ns   (sets the pulse width to 100 ns)
output on            (turns on the output)
source:volt 50V      (sets the voltage amplitude to 50 Volts)
trigger:source immediate (generates a single non-repetitive trigger event)
trigger:source hold  (turns off all triggering)
output off           (turns off the output)
```

To set the instrument to trigger from an external TTL signal applied to the rear-panel TRIG connector, use:

```
*rst                (resets the instrument)
trigger:source external (selects external triggering)
pulse:width 100 ns     (sets the pulse width to 100 ns)
pulse:delay 1 us       (sets the delay to 1 us)
source:volt 50V        (sets the voltage amplitude to 50 Volts)
output on              (turns on the output)
```

These commands will satisfy 90% of your programming needs.

ALL PROGRAMMING COMMANDS

For more advanced programmers, a complete list of the available commands is given below. These commands are described in detail in the “OP1B Interface Programming Manual”. (Note: this manual also includes some commands that are not implemented in this instrument. They can be ignored.)

<u>Keyword</u>	<u>Parameter</u>	<u>Notes</u>
DIAGnostic:		
:AMPLitude		
:CALibration:	<numeric value>	[no query form]
LOCAL		
MEASure:		
:AMPLitude?		[query only]
OUTPut:		
:[STATe]	<boolean value>	
:PROTection		
:TRIPped?		[query only]
REMOTE		
[SOURce]:		
:FREQuency		
[:CW FIXed]	<numeric value>	
[SOURce]:		
:VOLTag		
[:LEVel]		
[:IMMediate]		
[:AMPLitude]	<numeric value>	
:PROTection		
:TRIPped?		[query only]
[SOURce]:		
:PULSe		
:PERiod	<numeric value>	
:WIDTh	<numeric value>	
:DCYCl	<numeric value>	
:HOLD	WIDTh DCYCl	
:DELay	<numeric value>	
:GATE		
:TYPE	ASYNc SYNc	
:LEVel	High Low	
STATUS:		
:OPERation		
:[EVENT]?		[query only, always returns "0"]
:CONDition?		[query only, always returns "0"]
:ENABle	<numeric value>	[implemented but not useful]
:QUEStionable		
:[EVENT]?		[query only, always returns "0"]
:CONDition?		[query only, always returns "0"]
:ENABle	<numeric value>	[implemented but not useful]
SYSTEM:		
:COMMunicate		
:GPIB		
:ADDReSS	<numeric value>	

:SERial		
:CONTRol		
:RTS	ON IBFull RFR	
:[RECeive]		
:BAUD	1200 2400 4800 9600	
:BITS	7 8	
:ECHO	<boolean value>	
:PARity		
:[TYPE]	EVEN ODD NONE	
:SBITS	1 2	
:ERRor		
:[NEXT]?		[query only]
:COUNT?		[query only]
:VERSion?		[query only]
TRIGger:		
:SOURce	INTernal EXTernal MANual HOLD IMMEDIATE	[no query form]
*CLS		
*ESE	<numeric value>	
*ESR?		[query only]
*IDN?		[query only]
*OPC		
*SAV	0 1 2 3	[no query form]
*RCL	0 1 2 3	[no query form]
*RST		[no query form]
*SRE	<numeric value>	
*STB?		[query only]
*TST?		[query only]
*WAI		[no query form]

PERFORMANCE CHECK SHEET