

INSTRUCTIONS

MODEL AVOZ-B3-B

0 TO 100 Amp (0 to 100 Volts)
100 WATT HIGH-POWER
LASER DIODE DRIVER
WITH IEEE 488.2 AND RS-232 CONTROL

SERIAL NUMBER: _____

WARRANTY

Avtech Electrosystems Ltd. warrants products of its manufacture to be free from defects in material and workmanship under conditions of normal use. If, within one year after delivery to the original owner, and after prepaid return by the original owner, this Avtech product is found to be defective, Avtech shall at its option repair or replace said defective item. This warranty does not apply to units which have been disassembled, modified or subjected to conditions exceeding the applicable specifications or ratings. This warranty is the extent of the obligation assumed by Avtech with respect to this product and no other warranty or guarantee is either expressed or implied.

TECHNICAL SUPPORT

Phone: 613-226-5772 or 1-800-265-6681

Fax: 613-226-2802 or 1-800-561-1970

E-mail: info@avtechpulse.com

World Wide Web: <http://www.avtechpulse.com>

TABLE OF CONTENTS

WARRANTY.....	2
TECHNICAL SUPPORT.....	2
TABLE OF CONTENTS.....	3
INTRODUCTION.....	5
AVAILABLE OPTIONS.....	5
SPECIFICATIONS.....	6
INSTALLATION.....	7
VISUAL CHECK.....	7
PLUGGING IN THE INSTRUMENT.....	7
LABVIEW DRIVERS.....	8
FRONT PANEL CONTROLS.....	9
REAR PANEL CONTROLS.....	11
GENERAL INFORMATION.....	13
AMPLITUDE CONTROL.....	13
CONSTRUCTING AN APPROPRIATE SERIES RESISTOR.....	14
CONNECTING THE LOAD.....	15
LENZ'S LAW AND INDUCTIVE VOLTAGE SPIKES.....	15
BASIC PULSE CONTROL.....	16
TRIGGER MODES.....	17
GATING MODES.....	18
MECHANICAL INFORMATION.....	19
TOP COVER REMOVAL.....	19
RACK MOUNTING.....	19
MAINTENANCE.....	20
REGULAR MAINTENANCE.....	20
CLEANING.....	20
OPTIONS.....	21
-EA ELECTRONIC AMPLITUDE CONTROL OPTION.....	21
START-UP CHECK-LIST FOR LOCAL CONTROL.....	22
PROGRAMMING YOUR PULSE GENERATOR.....	24
KEY PROGRAMMING COMMANDS.....	24
ALL PROGRAMMING COMMANDS.....	25
APPENDIX A - LOW-VALUE, LOW-INDUCTANCE, HIGH-POWER RESISTORS.....	27

SUPPLIERS.....27
PERFORMANCE CHECK SHEET.....28

Manual Reference: /filesserver1/officefiles/instructword/avoz/AVOZ-B3-B,edition1.sxw

INTRODUCTION

The AVOZ-B3-B is a high-power GPIB and RS232-equipped instrument capable of generating 0 to 100V into loads of $R_L > 1.0\Omega$ (100 Amps maximum) at repetition rates up to 10 kHz. The pulse width is variable from 100 ns to 2 us, and the duty cycle may be as high as 1%. The maximum average power delivered to the load can be as high as 100 Watts. The rise time and fall times are 30 ns. The AVOZ-B3-B includes an internal trigger source, but it can also be triggered or gated by an external source. A front-panel pushbutton can also be used to trigger the instrument.

The AVOZ-B3-B features front panel keyboard and adjust knob control of the output pulse parameters along with a four line by 40-character backlit LCD display of the output amplitude, pulse width, pulse repetition frequency, and delay. The instrument includes memory to store up to four complete instrument setups. The operator may use the front panel or the computer interface to store a complete "snapshot" of all key instrument settings, and recall this setup at a later time.

The instrument is protected against overload conditions by an automatic control circuit. An internal power supply monitor removes the power to the output stage for five seconds if an average power overload exists. After that time, the unit operates normally for one second, and if the overload condition persists, the power is cut again. This cycle repeats until the overload is removed.

The AVOZ-B3-B is a voltage pulser, which generates 0 to 100V ($V_{\text{PROGRAMMED}}$) internally. When used with a diode load, the diode is connected in series with a resistance (R_{SERIES}), so that the current through the diode is given by:

$$I_{\text{DIODE}} \approx (V_{\text{PROGRAMMED}} - V_{\text{DIODE}}) / R_{\text{SERIES}}$$

where V_{DIODE} is the voltage drop across the diode. R_{SERIES} must be large enough (i.e. greater than 1.0Ω) such that the current never exceeds 100 Amps. R_{SERIES} must also have very low inductance, and be capable of dissipating up to 100 Watts of power.

The output module is connected to the instrument mainframe using 5-foot-long cables, allowing flexibility in the physical placement of the device under test.

AVAILABLE OPTIONS

This instrument is available with several options:

"-EA" Option: the amplitude can be controlled by an externally generated 0 to +10V analog control voltage.

SPECIFICATIONS

Model ¹ :	AVOZ-B3-B
Amplitude ^{2,3} : current: voltage:	0 to 100A 0 to 100V
Minimum load impedance ⁴ : (required to limit current)	1.0 Ω
Pulse width (FWHM):	100 – 2 us
Rise time:	\leq 30 ns
Fall time:	\leq 30 ns
Maximum PRF:	10 kHz
Duty cycle: (max)	1.00%
Output impedance:	$<$ 0.05 Ω
Average output power:	100 Watts maximum
Drop:	\leq 5%, at maximum pulse width and maximum amplitude
Polarity ⁵ :	Positive or negative or dual polarity (specify)
GPIO & RS-232 control ¹ :	Standard on -B units.
LabView drivers:	Check http://www.avtechpulse.com/labview for availability and downloads
Propagation delay:	\leq 100 ns (Ext trig in to pulse out)
Jitter:	\pm 100 ps (Ext trig in to pulse out)
Trigger required:	External trigger mode: + 5 Volts, 50 to 500 ns (TTL)
Sync delay: (sync out to pulse out)	Variable 0 to \pm 2 μ s
Sync output:	+ 3 Volt, 200 ns, will drive 50 Ohm loads
Gate input:	Synchronous or asynchronous, active high or low, switchable. Suppresses triggering when active.
Output transmission line:	flexible microstrip
length:	30 cm
characteristic impedance:	1 Ω
Output connection:	Solder terminals (or optional socket ⁶), on the end of the flexible microstrip transmission line
Other connectors:	Trig, Gate, Sync: BNC
Power requirements:	120/240 Volts (switchable) 50 - 60 Hz
Dimensions: Mainframe:	100 mm x 430 mm x 375 mm (3.9" x 17" x 14.8")
Output Module:	43 x 66 x 109 mm (1.7x2.6x4.3")
Chassis material:	Anodized aluminum, with blue plastic trim
Mounting:	Any
Temperature range:	+ 15° to + 40° C

- 1) -B suffix indicates IEEE-488.2 GPIB and RS-232 control of pulse amplitude, pulse width, delay and PRF. (See page 8).
- 2) For remote analog electronic control (0 to + 10V) of the amplitude, suffix model number with -EA. Electronic control units also include standard front-panel controls.
- 3) For operation at voltage amplitudes of less than 10% of full-scale, better results may be obtained by setting the amplitude near full-scale and increasing the load impedance accordingly.
- 4) For applications where additional resistance must be added in series with the device under test, Avtech recommends connecting multiple Ohmite OX or OY-series or RCD RSF2B resistors in parallel to create a high-power, low-inductance effective resistance.
- 5) Indicate desired polarity by suffixing model number with -P or -N (i.e. positive or negative) or -PN for dual polarity option.
- 6) To specify diode socket mounting option, suffix model number with -S5 and describe the diode package type (e.g. TO-18) and the required pin connections (eg. anode, cathode, ground, etc.). See page 75 for readily available package mounting. Contact Avtech for special or different packages.

INSTALLATION

VISUAL CHECK

After unpacking the instrument, examine to ensure that it has not been damaged in shipment. Visually inspect all connectors, knobs, liquid crystal displays (LCDs), and the handles. Confirm that a power cord, a GPIB cable, and two instrumentation manuals (this manual and the "OP1B Interface Programming Manual") are with the instrument. Confirm that an output module (two for dual-polarity units) is supplied, with a length of coaxial cable and a 25-pin control cable to connect it to the mainframe. If the instrument has been damaged, file a claim immediately with the company that transported the instrument.

PLUGGING IN THE INSTRUMENT

Examine the rear of the instrument. There will be a male power receptacle, a fuse holder and the edge of the power selector card visible. Confirm that the power selector card is in the correct orientation.

For AC line voltages of 110-120V, the power selector card should be installed so that the "120" marking is visible from the rear of the instrument, as shown below:

For AC line voltages of 220-240V, the power selector card should be installed so that the "240" marking is visible from the rear of the instrument, as shown below:

If it is not set for the proper voltage, remove the fuse and then grasp the card with a pair of pliers and remove it. Rotate horizontally through 180 degrees. Reinstall the card and the correct fuse.

In the 120V setting, a 2.0A slow blow fuse is required. In the 240V setting, a 1.0A slow blow fuse is required.

LABVIEW DRIVERS

A LabVIEW driver for this instrument is available for download on the Avtech web site, at <http://www.avtechpulse.com/labview>. A copy is also available in National Instruments' Instrument Driver Library at <http://www.natinst.com/>.

FRONT PANEL CONTROLS

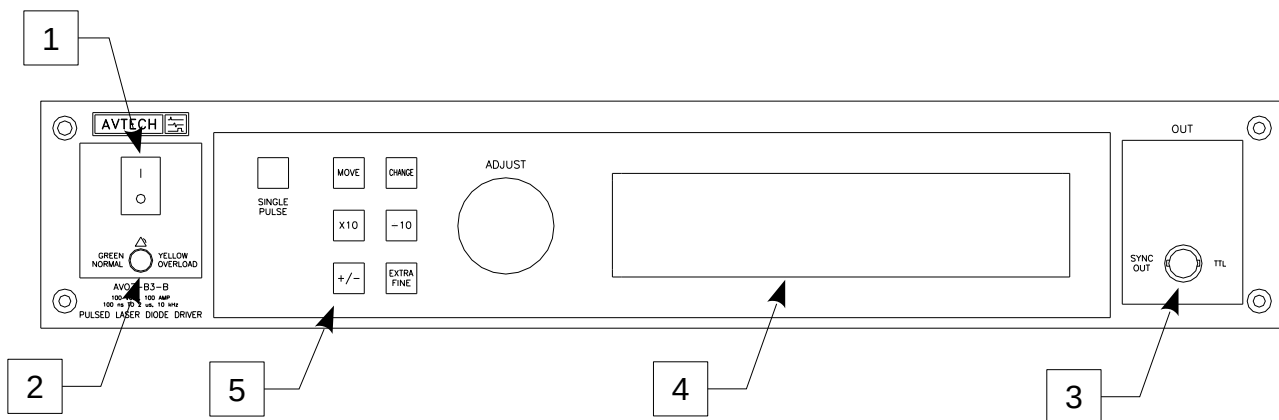

1. POWER Switch. This is the main power switch.
2. OVERLOAD Indicator. When the instrument is powered, this indicator is normally green, indicating normal operation. If this indicator is yellow, an internal automatic overload protection circuit has been tripped. If the unit is overloaded (by operating at an exceedingly high duty cycle or by operating into a very low impedance), the protective circuit will disable the output of the instrument and turn the indicator light yellow. The light will stay yellow (i.e. output disabled) for about 5 seconds after which the instrument will attempt to re-enable the output (i.e. light green) for about 1 second. If the overload condition persists, the output will be disabled again (i.e. light yellow) for another 5 seconds. If the overload condition has been removed, the instrument will resume normal operation.

This overload indicator is only likely to come on in two situations:

- Briefly at startup. This is not a cause for concern.
 - When the load impedance is too low ($< 1 \Omega$). In this case, turn off the instrument and connect the proper load.
3. SYNC OUT. This connector supplies a SYNC output that can be used to trigger other equipment, particularly oscilloscopes. This signal leads, or lags, the main output by a duration set by the "DELAY" controls and has an approximate amplitude of +3 Volts to $R_L > 1 \text{ k}\Omega$ with a pulse width of approximately 200 ns.

4. KEYPAD.

Control Name	Function
MOVE	This moves the arrow pointer on the display.
CHANGE	This is used to enter the submenu, or to select the operating mode, pointed to by the arrow pointer.
×10	If one of the adjustable numeric parameters is displayed, this increases the setting by a factor of ten.
÷10	If one of the adjustable numeric parameters is displayed, this decreases the setting by a factor of ten.
+/-	If one of the adjustable numeric parameters is displayed, and this parameter can be both positive or negative, this changes the sign of the parameter.
EXTRA FINE	This changes the step size of the ADJUST knob. In the extra-fine mode, the step size is twenty times finer than in the normal mode. This button switches between the two step sizes.
ADJUST	This large knob adjusts the value of any displayed numeric adjustable values, such as frequency, pulse width, etc. The adjust step size is set by the "EXTRA FINE" button. When the main menu is displayed, this knob can be used to move the arrow pointer.

5. LIQUID CRYSTAL DISPLAY (LCD). This LCD is used in conjunction with the keypad to change the instrument settings. Normally, the main menu is displayed, which lists the key adjustable parameters and their current values. The "OP1B Interface Programming Manual" describes the menus and submenus in detail.

REAR PANEL CONTROLS

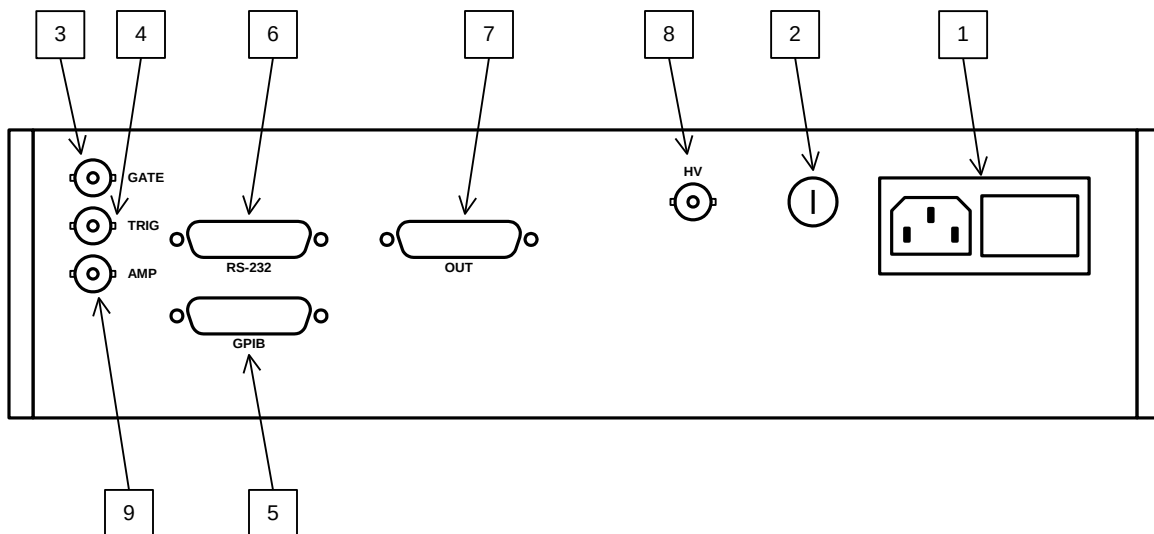

1. AC POWER INPUT. A three-pronged recessed male connector is provided on the back panel for AC power connection to the instrument. Also contained in this assembly is a slow-blow fuse and a removable card that can be removed and repositioned to switch between 120V AC in and 240V AC in.

For AC line voltages of 110-120V, the power selector card should be installed so that the “120” marking is visible from the rear of the instrument.

For AC line voltages of 220-240V, the power selector card should be installed so that the “240” marking is visible from the rear of the instrument.

If it is not set for the proper voltage, remove the fuse and then grasp the card with a pair of pliers and remove it. Rotate horizontally through 180 degrees. Reinstall the card and the correct fuse.

In the 120V setting, a 2.0A slow blow fuse is required. In the 240V setting, a 1.0A slow blow fuse is required. See the “Installation” section for more details.

2. 6.3A Time-Delay Fuses. This 6.3A fuse protects the output stage.
3. GATE. This TTL-level (0 and +5V) logic input can be used to gate the triggering of the instrument. This input can be either active high or active low, depending on the front panel settings or programming commands. (The instrument triggers normally when this input is unconnected). When set to active high mode, this input is pulled-down to ground by a 1 k Ω resistor. When set to active low mode, this input is pulled-up to +5V by a 1 k Ω resistor.

4. TRIG. This TTL-level (0 and +5V) logic input can be used to trigger the instrument, if the instrument is set to triggering externally. The instrument triggers on the rising edge of this input. The input impedance of this input is 1 k Ω . (Depending on the length of cable attached to this input, and the source driving it, it may be desirable to add a coaxial 50 Ohm terminator to this input to provide a proper transmission line termination. The Pasternack (www.pasternack.com) PE6008-50 BNC feed-thru 50 Ohm terminator is suggested for this purpose.)
5. GPIB Connector. A standard GPIB cable can be attached to this connector to allow the instrument to be computer-controlled. See the "OP1B Interface Programming Manual" for more details on GPIB control.
6. RS-232 Connector. A standard serial cable with a 25-pin male connector can be attached to this connector to allow the instrument to be computer-controlled. See the "OP1B Interface Programming Manual" for more details on RS-232 control.
7. OUT Connector. This is a 25-pin connector which attaches the 5-foot-long, 25-pin cable from the pulse generator module to the mainframe.
8. HV. This is the high voltage power supply for the output module. It is connected directly to the output module with the supplied BNC-connectorized 5-foot RG-58 coaxial cable.

 Caution: Voltages as high as 100V may be present on the center conductor of this output connector. Avoid touching this conductor. Connect to this connector using standard coaxial cable, to ensure that the center conductor is not exposed.

9. AMP Connector. (Optional feature. Present on -EA units only.) The output amplitude can be set to track the voltage on the rear-panel "AMP" input. Zero Volts in corresponds to zero amplitude output, and +10V in corresponds to maximum amplitude out. This mode is activated by selecting "Ext Control" on the front-panel amplitude menu, or with the "source:voltage external" command.

GENERAL INFORMATION

AMPLITUDE CONTROL

The AVOZ-B3-B is a voltage pulser, which generates 0 to 100V ($V_{\text{PROGRAMMED}}$) internally. When used with a diode load, the diode is connected in series with a resistance (R_{SERIES}), so that the current through the diode is given by:

$$I_{\text{DIODE}} \approx (V_{\text{PROGRAMMED}} - V_{\text{DIODE}}) / R_{\text{SERIES}}$$

where V_{DIODE} is the voltage drop across the diode. R_{SERIES} must be large enough (i.e. greater than 1.0Ω) such that the current never exceeds 100 Amps.

R_{SERIES} should be made as large as possible, to obtain the best waveforms.

The basic scheme for connecting the mainframe and the output module to a laser diode load is shown below:

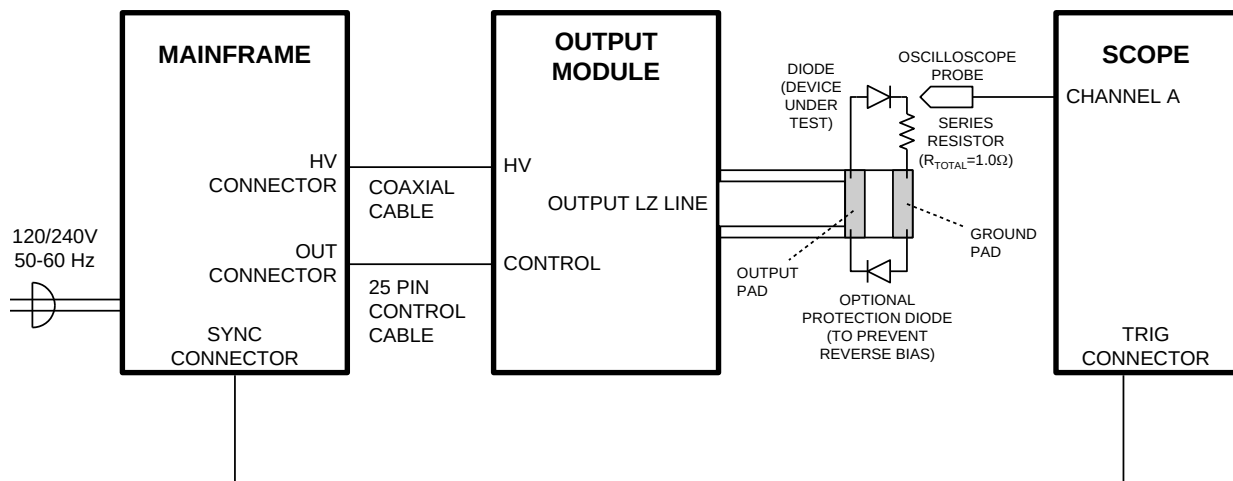

The diodes are shown oriented for a positive current. For negative currents, reverse the diodes.

Since the AVOZ-B3-B provides an output pulse rise time as low as 30 ns, a fast oscilloscope (at least 200 MHz) should be used to display the waveform.

The output module should always be connected to the mainframe BEFORE power is applied.

It is essential that a low-inductance current limiting resistor be placed in series with the laser diode load, particularly if the diode has a low series resistance. This is necessary because the driver is a pulsed voltage source and with a highly nonlinear load such as a laser diode it will be extremely difficult to control and limit the load current without a fixed series resistance.

CONSTRUCTING AN APPROPRIATE SERIES RESISTOR

As noted above, a series resistance is required in the load, to limit the current to 100 Amps. This resistance must have very low inductance (see the discussion of Lenz's Law below), and must be capable of dissipating considerable power. The power dissipated in the resistance may be calculated from:

$$P_{\text{RESISTOR}} \approx (\text{Duty Cycle}) \times (V_{\text{PROGRAMMED}} - V_{\text{DIODE}})^2 / R_{\text{SERIES}}$$

The worst-case dissipation is $1\% \times (100\text{V})^2 / 1 \text{ Ohm} = 100 \text{ Watts}$.

The best approach for obtaining a low-value, low-inductance resistor is to connect many higher-value resistors in parallel. Connecting resistors in parallel reduces the total effective resistance and inductance.

Avtech does not recommend the use of single, high-power resistors, even if they are low-inductance types. These resistors experience high failure rates in pulsed applications. Do not use wire-wound resistors. Their inductance is much too high.

The Ohmite OY series of 2 Watt ceramic composition resistors are extremely rugged and well suited to pulsed applications. (See Appendix A for more information.) Use several (e.g., 10) of these resistors in parallel to construct a high-current, high-power, low-inductance load.

For power dissipation of 0 – 20 Watts, Avtech recommends using ten 10 Ohm Ohmite OY resistors connected in parallel, with very short lead lengths. If the resistors are submerged in a cool water bath, this arrangement may be suitable for power dissipation up to 100 Watts. If water-cooling is not practical, then simply use more resistors in parallel, and use a fan to cool the resistors.

The photo below shows example of a 1 Ohm, 20W load constructed from ten 10 Ohm, 2W Ohmite OY resistors. Five resistors are soldered to each side of two copper strips.

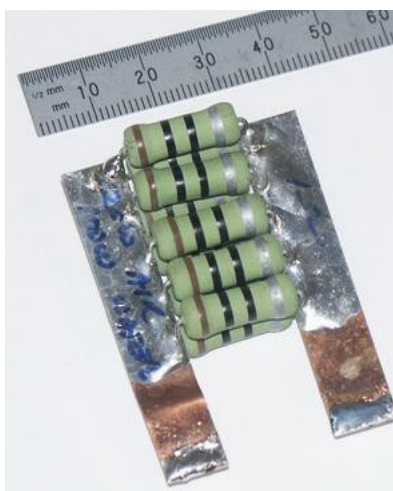

CONNECTING THE LOAD

The loads can be connected to the LZ1 flexible transmission line, which is terminated with a small circuit board.

The diode load and a non-inductive load resistor should be solder-connected to the end of the line as shown below (using extremely short lead lengths, e.g. 0.2 cm, to reduce inductance). The series combination of the laser diode and the load resistor R_L should present 1.0Ω to the end of the line. The instrument generates up to 100 Volts to provide a peak load current of 100 Amperes. For many diodes, a load resistor 1.0Ω may be selected as a first choice. An ultra fast rectifier diode may be placed across the laser diode to protect against reverse transients. Note that the net load resistance may be higher than 1.0Ω but in this case the peak current will be less than 100 Amperes.

The end of the LZ1 line is illustrated below:

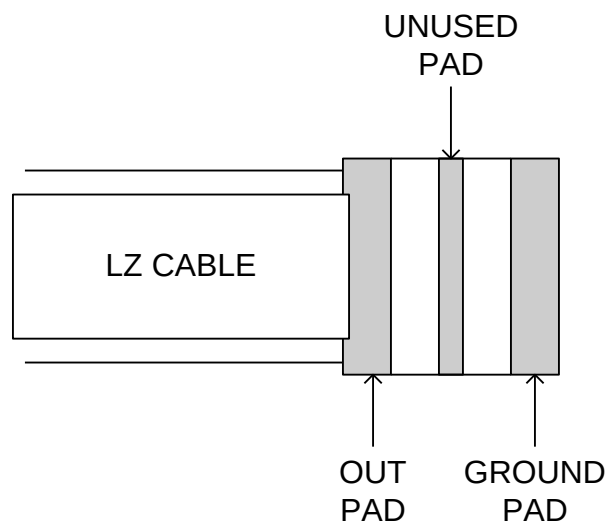

LENZ'S LAW AND INDUCTIVE VOLTAGE SPIKES

This instrument is designed to pulse resistive and diode loads and will exhibit a large output spike when used to drive a load with significant inductance (as predicted by LENZ'S LAW). For this reason the load should be connected to the output using low inductance leads (as short as possible and as heavy a gauge as possible).

The voltage developed across an inductance L (in Henries), when the current is changing at a rate given by di_{LOAD}/dt (in Amps/sec), is: $V_{SPIKE} = L \times di_{LOAD}/dt$.

If significant inductance is present in the load, noticeable degradation of the rise and fall times may also occur.

BASIC PULSE CONTROL

This instrument can be triggered by its own internal clock or by an external TTL trigger signal. In either case, two output channels respond to the trigger: OUT and SYNC. The OUT channel is the signal that is applied to the load. Its amplitude and pulse width are variable. The SYNC pulse is a fixed-width TTL-level reference pulse used to trigger oscilloscopes or other measurement systems. When the delay is set to a positive value the SYNC pulse precedes the OUT pulse. When the delay is set to a negative value the SYNC pulse follows the OUT pulse.

These pulses are illustrated below, assuming internal triggering, positive delay, and positive amplitude:

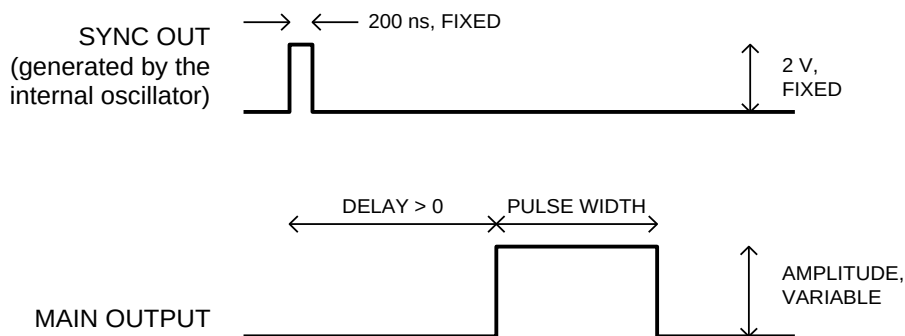

Figure A

If the delay is negative, the order of the SYNC and OUT pulses is reversed:

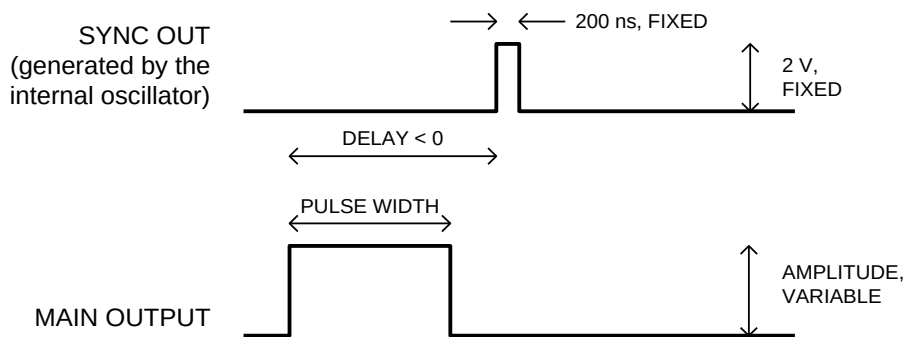

Figure B

The next figure illustrates the relationship between the signals when an external TTL-level trigger is used:

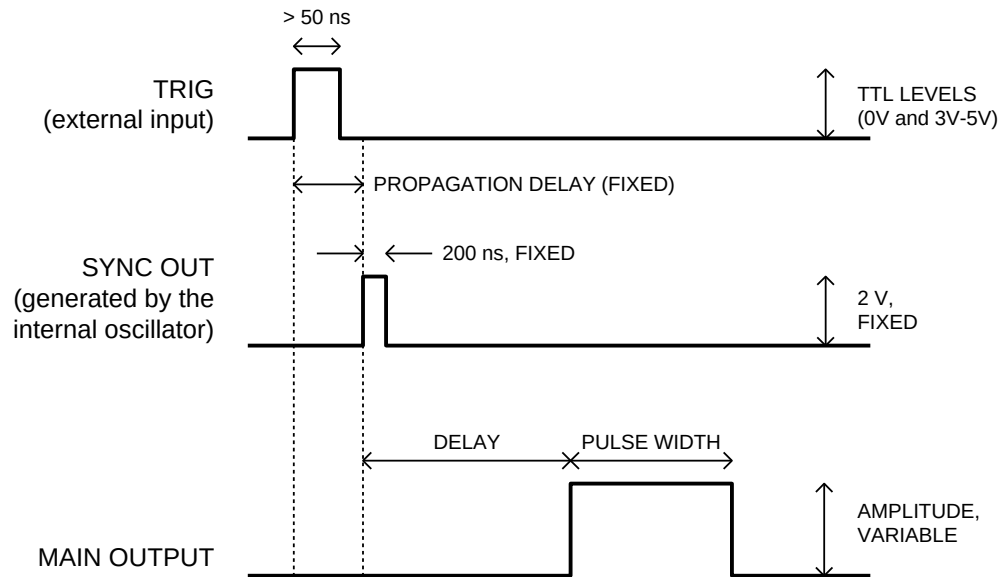

Figure C

As before, if the delay is negative, the order of the SYNC and OUT pulses is reversed.

The delay, pulse width, and frequency (when in the internal mode), of the OUT pulse can be varied with front panel controls or via the GPIB or RS-232 computer interfaces.

TRIGGER MODES

This instrument has four trigger modes:

- Internal Trigger: the instrument controls the trigger frequency, and generates the clock internally.
- External Trigger: the instrument is triggered by an external TTL-level clock on the back-panel TRIG connector.
- Manual Trigger: the instrument is triggered by the front-panel "SINGLE PULSE" pushbutton.
- Hold Trigger: the instrument is set to not trigger at all.

These modes can be selected using the front panel trigger menu, or by using the appropriate programming commands. (See the "OP1B Interface Programming Manual" for more details.)

GATING MODES

Triggering can be suppressed by a TTL-level signal on the rear-panel GATE connector. The instrument can be set to stop triggering when this input high or low, using the front-panel gate menu or the appropriate programming commands. This input can also be set to act synchronously or asynchronously. When set to asynchronous mode, the GATE will disable the output immediately. Output pulses may be truncated. When set to synchronous mode, the output will complete the full pulse width if the output is high, and then stop triggering. No pulses are truncated in this mode.

MECHANICAL INFORMATION

TOP COVER REMOVAL

If necessary, the interior of the instrument may be accessed by removing the four Phillips screws on the top panel. With the four screws removed, the top cover may be slid back (and off).

Always disconnect the power cord before opening the instrument.

There are no user-adjustable internal circuits. For repairs other than fuse replacement, please contact Avtech (info@avtechpulse.com) to arrange for the instrument to be returned to the factory for repair.

⚠ Caution: High voltages are present inside the instrument during normal operation. Do not operate the instrument with the cover removed.

RACK MOUNTING

A rack mounting kit is available. The -R5 rack mount kit may be installed after first removing the one Phillips screw on the side panel adjacent to the front handle.

MAINTENANCE

REGULAR MAINTENANCE

This instrument does not require any regular maintenance.

On occasion, one or more of the rear-panel fuses may require replacement. All fuses can be accessed from the rear panel.

CLEANING

If desired, the interior of the instrument may be cleaned using compressed air to dislodge any accumulated dust. (See the "TOP COVER REMOVAL" section for instructions on accessing the interior.) No other cleaning is recommended.

OPTIONS

This instrument is available with these options:

-EA ELECTRONIC AMPLITUDE CONTROL OPTION

The output amplitude can be set to track the voltage on the rear-panel "AMP" input. Zero Volts in corresponds to zero amplitude output, and +10V in corresponds to maximum amplitude out. This mode is activated by selecting "Ext Control" on the front-panel amplitude menu, or with the "source:voltage external" command.

START-UP CHECK-LIST FOR LOCAL CONTROL

- 1) The instruction manual has been studied thoroughly.
- 2) The “Local Control” section of the “OP1B Interface Programming Manual” has been studied thoroughly.
- 3) The -PG module is connected to the mainframe as shown in the “Basic Test Arrangement” section. (The output module should always be connected to the mainframe BEFORE power is applied.)
- 4) The load is connected to the output module. If the load is a diode, the anode of the load is connected to the OUT terminal. Note that with a diode load, a low-inductance current limiting high power resistor must be placed in series with the diode to help limit the peak current. For initial testing, it is recommended that a resistive load be used. Factory tests are conducted using a 1.0 Ohm, 20 Watt resistive load, consisting of ten 10 Ω , 2 Watt resistors connected in parallel. The resistors are submersed in water to extend the power handling capability to 100 Watts. (See the appendix for a list of recommended resistors).
- 5) Turn on the prime power to the mainframe.
- 6) The arrow pointer should be pointing at the frequency menu item. If it is not, press the MOVE button until it is.
- 7) Press the CHANGE button. The frequency submenu will appear. Rotate the ADJUST knob until the frequency is set at the desired setting. The arrow pointer should be pointing at the “Internal” choice. If it is not, press MOVE until it is.
- 8) Press CHANGE to return to the main menu.
- 9) Press the MOVE button to move the arrow pointer to the pulse width menu item. Press CHANGE to bring up the pulse width submenu, and rotate the ADJUST knob until the pulse width is set at the desired setting. The arrow pointer should be pointing at the “Normal” choice. If it is not, press MOVE until it is. Press CHANGE to return to the main menu.
- 10) Press the MOVE button to move the arrow pointer to the pulse width menu item. Press CHANGE to bring up the pulse width submenu, and rotate the ADJUST knob until the pulse width is set at the desired setting. The arrow pointer should be pointing at the “Normal” choice. If it is not, press MOVE until it is. Press CHANGE to return to the main menu.
- 11) Press the MOVE button to move the arrow pointer is pointing at the output item. Press CHANGE to bring up the output submenu. The arrow pointer should be initially be pointing at the “Output Off” choice. Press MOVE so that the arrow pointer is pointing at the “Output On” choice. (The mainframe is now supplying a

trigger to the output module.) Press CHANGE to return to the main menu.

- 12) Connect a scope probe across the resistive test load.
- 13) Press the MOVE button to move the arrow pointer to the amplitude menu item. Press CHANGE to bring up the amplitude submenu, and rotate the ADJUST knob until the amplitude is set at the desired setting. A rectangular pulse should appear on the scope and the amplitude should increase as the amplitude control on the mainframe is rotated clockwise.
- 14) Adjust pulse width, pulse period (i.e. PRF) and amplitude to obtain the desired settings.
- 15) If additional assistance is required:

Tel: (613) 226-5772, Fax: (613) 226-2802
Email: info@avtechpulse.com

PROGRAMMING YOUR PULSE GENERATOR

KEY PROGRAMMING COMMANDS

The “OP1B Interface Programming Manual” describes in detail how to connect the pulse generator to your computer, and the programming commands themselves. A large number of commands are available; however, normally you will only need a few of these. Here is a basic sample sequence of commands that might be sent to the instrument after power-up:

*rst	(resets the instrument)
trigger:source internal	(selects internal triggering)
frequency 100 Hz	(sets the frequency to 100 Hz)
pulse:width 1 us	(sets the pulse width to 1 us)
pulse:delay 2 us	(sets the delay to 2 us)
volt 100	(sets the amplitude to 100 V)
output on	(turns on the output)

For triggering a single event, this sequence would be more appropriate:

*rst	(resets the instrument)
trigger:source hold	(turns off all triggering)
pulse:width 1 us	(sets the pulse width to 1 us)
output on	(turns on the output)
volt 100	(sets the amplitude to 100 V)
trigger:source immediate	(generates a single non-repetitive trigger event)
trigger:source hold	(turns off all triggering)
output off	(turns off the output)

To set the instrument to trigger from an external TTL input:

*rst	(resets the instrument)
trigger:source external	(selects external triggering)
pulse:width 1 us	(sets the pulse width to 1 us)
pulse:delay 2 us	(sets the delay to 2 us)
volt 100	(sets the amplitude to 100 V)
output on	(turns on the output)

These commands will satisfy 90% of your programming needs.

ALL PROGRAMMING COMMANDS

For more advanced programmers, a complete list of the available commands is given below. These commands are described in detail in the “OP1B Interface Programming Manual”. (Note: this manual also includes some commands that are not implemented in this instrument. They can be ignored.)

<u>Keyword</u>	<u>Parameter</u>	<u>Notes</u>
LOCAL		
OUTPut:		
:[STATE]	<boolean value>	
:PROTection		
:TRIPped?		[query only]
REMOTE		
[SOURce]:		
:FREQuency		
[:CW FIXed]	<numeric value>	
[SOURce]:		
:PULSe		
:PERiod	<numeric value>	
:WIDTh	<numeric value>	
:DCYClE	<numeric value>	
:HOLD	WIDTh DCYClE	
:DELay	<numeric value>	
:GATE		
:TYPE	ASYNc SYNc	
:LEVel	HIgh LOw	
[SOURce]:		
:VOLTage		
[:LEVel]		
[:IMMEdiate]		
[:AMPLitude]	<numeric value> EXTeRnal	
:PROTection		
:TRIPped?		[query only]
STATUS:		
:OPERation		
:[EVENT]?		[query only, always returns "0"]
:CONDition?		[query only, always returns "0"]
:ENABle	<numeric value>	[implemented but not useful]
:QUEStionable		
:[EVENT]?		[query only, always returns "0"]
:CONDition?		[query only, always returns "0"]
:ENABle	<numeric value>	[implemented but not useful]
SYSTEM:		
:COMMunicate		
:GPIB		
:ADDReSS	<numeric value>	
:SERial		
:CONTRol		
:RTS	ON IBFull RFR	
:[RECEive]		
:BAUD	1200 2400 4800 9600	
:BITS	7 8	
:ECHO	<boolean value>	

	:PARity		
	: [TYPE]	EVEN ODD NONE	
	:SBITS	1 2	
	:ERRor		
	: [NEXT]?		[query only]
	:COUNT?		[query only]
	:VERSion?		[query only]
TRIGger:			
	:SOURce	INTernal EXTernal MANual HOLD IMMEDIATE	
*CLS			[no query form]
*ESE		<numeric value>	
*ESR?			[query only]
*IDN?			[query only]
*OPC			
*SAV		0 1 2 3	[no query form]
*RCL		0 1 2 3	[no query form]
*RST			[no query form]
*SRE		<numeric value>	
*STB?			[query only]
*TST?			[query only]
*WAI			[no query form]

APPENDIX A - LOW-VALUE, LOW-INDUCTANCE, HIGH-POWER RESISTORS

The best approach for obtaining a low-value, low-inductance resistor is to connect many higher-value resistors in parallel. Connecting resistors in parallel reduces the total effective resistance and inductance.

Avtech does not recommend the use of single, high-power resistors, even if they are low-inductance types. These resistors experience high failure rates in pulsed applications.

SUPPLIERS

- Ohmite Mfg. Co.
3601 Howard Street
Skokie, IL 60076
Tel: (847) 675- 2600
Fax: (847) 675- 1505
www.ohmite.com

The Ohmite OY series of 2 Watt ceramic composition resistors are extremely rugged and well suited to pulsed applications. Use several (e.g., 4 or 5) of these resistors in parallel to construct a high-current, high-power, low-inductance load.

These resistors are readily available from Digi-Key (www.digikey.com).

- RCD COMPONENTS INC.
520 East Industrial Park.,
Manchester, NH USA 03109- 5316
Tel: (603) 669-0054
Fax: (603) 669-5455
www.rcd-comp.com

The RCD RSF2B series of 2 Watt ceramic composition resistors are rugged and well suited to pulsed applications (although not as well suited as the Ohmite OY series). Use several (e.g., 4 or 5) of these resistors in parallel to construct a high-current, high-power, low-inductance load.

PERFORMANCE CHECK SHEET