



AVTECH ELECTROSYSTEMS LTD.

NANOSECOND WAVEFORM ELECTRONICS
SINCE 1975

P.O. BOX 265
OGDENSBURG, NY
U.S.A. 13669-0265

TEL: 888-670-8729 (USA & Canada) or +1-613-686-6675 (Intl)
FAX: 800-561-1970 (USA & Canada) or +1-613-686-6679 (Intl)

info@avtechpulse.com - <http://www.avtechpulse.com/>

BOX 5120, LCD MERIVALE
OTTAWA, ONTARIO
CANADA K2C 3H4

INSTRUCTIONS

MODEL AVR-3-PS-PN-UHH

0 TO ± 200 VOLTS, 25 kHz

HIGH SPEED PULSE GENERATOR

WITH < 250 ns RISE & FALL TIMES

SERIAL NUMBER: _____

WARRANTY

Avtech Electrosystems Ltd. warrants products of its manufacture to be free from defects in material and workmanship under conditions of normal use. If, within one year after delivery to the original owner, and after prepaid return by the original owner, this Avtech product is found to be defective, Avtech shall at its option repair or replace said defective item. This warranty does not apply to units which have been disassembled, modified or subjected to conditions exceeding the applicable specifications or ratings. This warranty is the extent of the obligation assumed by Avtech with respect to this product and no other warranty or guarantee is either expressed or implied.

TECHNICAL SUPPORT

Phone: 888-670-8729 (USA & Canada) or +1-613-686-6675 (International)

Fax: 800-561-1970 (USA & Canada) or +1-613-686-6679 (International)

E-mail: info@avtechpulse.com

World Wide Web: <http://www.avtechpulse.com>

TABLE OF CONTENTS

WARRANTY.....	2
TECHNICAL SUPPORT.....	2
TABLE OF CONTENTS.....	3
INTRODUCTION.....	5
SPECIFICATIONS & ORIGINAL QUOTATION.....	6
REGULATORY NOTES.....	8
FCC PART 18.....	8
EC DECLARATION OF CONFORMITY.....	8
DIRECTIVE 2002/95/EC (RoHS).....	9
DIRECTIVE 2002/96/EC (WEEE).....	9
AC POWER SUPPLY REGULATORY NOTES.....	10
INSTALLATION.....	11
VISUAL CHECK.....	11
POWER RATINGS.....	11
CONNECTION TO THE POWER SUPPLY.....	11
PROTECTION FROM ELECTRIC SHOCK.....	12
ENVIRONMENTAL CONDITIONS.....	13
FUSES.....	14
AC FUSE REPLACEMENT.....	14
DC FUSE REPLACEMENT.....	15
FUSE RATINGS.....	15
FRONT PANEL CONTROLS.....	16
REAR PANEL CONTROLS.....	18
GENERAL INFORMATION.....	19
BASIC TEST ARRANGEMENT.....	19
PROTECTING YOUR INSTRUMENT.....	20
TURN OFF INSTRUMENT WHEN NOT IN USE.....	20
TURN OFF INSTRUMENT DURING SHORT CIRCUITS.....	20
DO NOT EXCEED 25 kHz.....	20
USE LOW-INDUCTANCE LOADS.....	20
MECHANICAL INFORMATION.....	21
TOP COVER REMOVAL.....	21

RACK MOUNTING.....	21
ELECTROMAGNETIC INTERFERENCE.....	21
MAINTENANCE.....	22
REGULAR MAINTENANCE.....	22
CLEANING.....	22
WIRING DIAGRAMS.....	23
WIRING OF AC POWER.....	23
WIRING OF DC POWER.....	24
PCB 158N - LOW VOLTAGE POWER SUPPLY, 1/3.....	25
PCB 158N - LOW VOLTAGE POWER SUPPLY, 2/3.....	26
PCB 158N - LOW VOLTAGE POWER SUPPLY, 3/3.....	27
PCB 197A - HIGH VOLTAGE POWER SUPPLY PCB.....	28
PCB 156C - POLARITY CONTROL PCB (-PN UNITS).....	29
PCB 183A-S AND 183A-P CAPACITOR BANKS.....	30
PRF LIMITER - PCB 206A.....	31
MAIN WIRING.....	32
PERFORMANCE CHECK SHEET.....	33

INTRODUCTION

The AVR-3-PS-PN-UHH is an externally-triggered high-voltage pulse generator, capable of generating up to $\pm 200\text{V}$ at repetition rates up to 25 kHz. The output pulse width is approximately equal to the input pulse width, and may vary over the range of 2 to 200 μs . The maximum duty cycle is 57.5%. The rise time and fall times are less than 250 ns.

The output will drive loads with resistances of 500 Ohms or higher, and capacitances of 20 nF or lower. The voltage stability after 2 μs is ± 1 Volt. The maximum average output power is 66 Watts.

The output is current-limited at 30 Amps, approximately. The output will be disabled for 3 seconds if the current limit is active for longer than 5 μs , approximately, to protect the instrument from short-circuits. The protective disabling will repeat as long as the over-current condition persists. The instrument will not be damaged by short circuits to ground on the output.

An external TTL pulse is required to trigger the instrument.

This instrument is intended for use in research, development, test and calibration laboratories by qualified personnel.

SPECIFICATIONS & ORIGINAL QUOTATION

Date: Fri, 24 Jun 2011 11:39:58 -0400
From: Avtech Sales

XXXXX,

Following our phone conference yesterday, I am pleased to re-quote as follows:

Quote number: 15710

Model number: AVR-3-PS-PN-UHH

Description: Externally-Triggered High-Voltage Pulse Generator

Note: This is a new customized pulser, with a bipolar output, higher maximum PRF (25 kHz), and a higher maximum surge current (30 A). Otherwise, it is similar to your existing AVR-3-PS-P-UHF S/N 11410.

Output amplitude: 0 to +/- 200V, adjustable using a front-panel ten-turn dial and a +/- polarity switch.

Required load: Resistance (RL) > 500 Ohms, capacitance (CL) < 20 nF.

Output impedance (in series with output): 1 Ohm, approximately.

Rise and fall times (20%-80%): < 250 ns, into RL > 500 Ohms, capacitance CL < 20 nF.

Maximum pulse repetition frequency: 25 kHz

Maximum duty cycle: 57.5%

Pulse width range: 2-200 us (defined by input trigger pulse)

Voltage stability after 2 us: +/- 1 Volt, when tested in a load consisting of a 500 Ohm resistance in parallel with a 20 nF capacitance on the end of a 24" inch length of coaxial cable.

Maximum average power out, given by $(\text{Duty Cycle} \times \text{VOUT}^2 / \text{RL}) + (\text{PRF} \times \text{CL} \times \text{VOUT}^2)$: 66 Watts.

Trigger required: The instrument must be triggered by an externally generated TTL pulse. Each input pulse will trigger one output pulse. The output pulse width will be approximately equal to the input pulse width. The input impedance of the trigger input is 50 Ohms.

Short-circuit protection and current limit: The output is current-limited at 30 Amps, approximately. The output will be shut off if the current limit is active for longer than 5 us, approximately, to protect the instrument from short-circuits. The instrument will not be damaged by short circuits to ground on the output.

Power requirement: 100-240V, 50-60 Hz.

Price: \$XXXXX US each (includes 5% academic discount), DAP (Delivered At Place). Includes the cost of shipping and insurance, but excludes customs duties, taxes, and other import fees. Shipments are from Canada, via FedEx, and are normally duty-free. (Customers who wish to order from an authorized US reseller to avoid international shipping can contact Sales@Testequipmentconnection.com for an alternative quotation.)

Quote valid for: 8 weeks

Terms: Net 30 days.

Note: Orders with Avtech are non-cancelable, non-refundable. Avtech does not offer returns, due to the highly-specialized low-volume nature of our instruments.

Estimated delivery: 8-10 weeks after receipt of order.

End Use Statement: An "End Use Statement - Low Speed Models" form must be completed when ordering, to determine if any special export control regulations apply. We can not process your order without this information. The necessary form is attached (in PDF format), and is also available at:

<http://www.avtechpulse.com/end-use/EndUseStatement,LowSpeed,v8.pdf>

Please note that you will have to confirm that these specifications (particularly the maximum average power) are suitable for your load, since we are not sure how exactly your plasma load can be characterized electrically.

Please call or email me if I can be of further assistance.

Thank you for your interest in our products!

Regards,

Dr. Michael J. Chudobiak
Chief Engineer

--- Avtech Electrosystems Ltd. ----- since 1975 ---

PO Box 265	ph: 888-670-8729 or 613-686-6675	Box 5120
Ogdensburg	fax: 800-561-1970 or 613-686-6679	LCD Merivale
New York		Ottawa, Ontario
USA 13669-0265	info@avtechpulse.com	Canada K2C 3H4
	www.avtechpulse.com	

Pulse Generators - Laser Diode Drivers - HV Amplifiers
Monocycle Generators - Impulse Generators - Pulse Amplifiers
Function Generators - Frequency Dividers - Standard & Customized

REGULATORY NOTES

FCC PART 18

This device complies with part 18 of the FCC rules for non-consumer industrial, scientific and medical (ISM) equipment.

This instrument is enclosed in a rugged metal chassis and uses a filtered power entry module (where applicable). The main output signal is provided on a shielded connector that is intended to be used with shielded coaxial cabling and a shielded load. Under these conditions, the interference potential of this instrument is low.

If interference is observed, check that appropriate well-shielded cabling is used on the output connectors. Contact Avtech (info@avtechpulse.com) for advice if you are unsure of the most appropriate cabling. Also, check that your load is adequately shielded. It may be necessary to enclose the load in a metal enclosure.

If any of the connectors on the instrument are unused, they should be covered with shielded metal "dust caps" to reduce the interference potential.

This instrument does not normally require regular maintenance to minimize interference potential. However, if loose hardware or connectors are noted, they should be tightened. Contact Avtech (info@avtechpulse.com) if you require assistance.

EC DECLARATION OF CONFORMITY



We Avtech Electrosystems Ltd.
 P.O. Box 5120, LCD Merivale
 Ottawa, Ontario
 Canada K2C 3H4

declare that this pulse generator meets the intent of Directive 2004/108/EG for Electromagnetic Compatibility. Compliance pertains to the following specifications as listed in the official Journal of the European Communities:

EN 50081-1 Emission

EN 50082-1 Immunity

and that this pulse generator meets the intent of the Low Voltage Directive 72/23/EEC as amended by 93/68/EEC. Compliance pertains to the following specifications as listed in the official Journal of the European Communities:

EN 61010-1:2001 Safety requirements for electrical equipment for measurement, control, and laboratory use

DIRECTIVE 2002/95/EC (RoHS)

This instrument is exempt from Directive 2002/95/EC of the European Parliament and of the Council of 27 January 2003 on the Restriction of the use of certain Hazardous Substances (RoHS) in electrical and electronic equipment. Specifically, Avtech instruments are considered "Monitoring and control instruments" (Category 9) as defined in Annex 1A of Directive 2002/96/EC. The Directive 2002/95/EC only applies to Directive 2002/96/EC categories 1-7 and 10, as stated in the "Article 2 - Scope" section of Directive 2002/95/EC.

DIRECTIVE 2002/96/EC (WEEE)

European customers who have purchased this equipment directly from Avtech will have completed a "WEEE Responsibility Agreement" form, accepting responsibility for WEEE compliance (as mandated in Directive 2002/96/EC of the European Union and local laws) on behalf of the customer, as provided for under Article 9 of Directive 2002/96/EC.

Customers who have purchased Avtech equipment through local representatives should consult with the representative to determine who has responsibility for WEEE compliance. Normally, such responsibilities will lie with the representative, unless other arrangements (under Article 9) have been made.

Requirements for WEEE compliance may include registration of products with local governments, reporting of recycling activities to local governments, and financing of recycling activities.

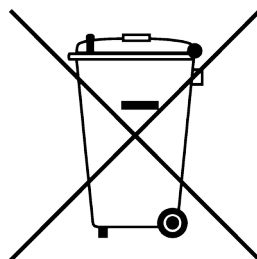

AC POWER SUPPLY REGULATORY NOTES

This instrument converts the AC input power to the +24V DC voltage that powers the internal circuitry of this instrument using a Tamura AAD130SD-60-A switching power supply. According to the manufacturer, the Tamura AAD130SD-60-A has the following certifications:

UL60950-1
IEC60950 -1
CSA C22.2 No. 60950- 1
EN60950 -1

and is compliant with:

EN61000-3-2
EN61000-4-2 Level 2
EN61000-4-2 Level 3 (Air Only)
EN61000-4-4 Level 3
EN61000-4-5 Level 3
EN61000-4-11
CISPR 11 and 22 FCC Part 15 Class B (conducted)

INSTALLATION

VISUAL CHECK

After unpacking the instrument mainframe and the transformer module, examine to ensure that they have not been damaged in shipment. Visually inspect all connectors, knobs, and handles. Confirm that a power cord and an instrumentation manual (this manual), are with the instrument. If the instrument has been damaged, file a claim immediately with the company that transported the instrument.

POWER RATINGS

This instrument is intended to operate from 100 - 240 V, 50 - 60 Hz.

The maximum power consumption is 150 Watts. Please see the “FUSES” section for information about the appropriate AC and DC fuses.

This instrument is an “Installation Category II” instrument, intended for operation from a normal single-phase supply.

CONNECTION TO THE POWER SUPPLY

An IEC-320 three-pronged recessed male socket is provided on the back panel for AC power connection to the instrument. One end of the detachable power cord that is supplied with the instrument plugs into this socket. The other end of the detachable power cord plugs into the local mains supply. Use only the cable supplied with the instrument. The mains supply must be earthed, and the cord used to connect the instrument to the mains supply must provide an earth connection. (The supplied cord does this.)

 Warning: Failure to use a grounded outlet may result in injury or death due to electric shock. This product uses a power cord with a ground connection. It must be connected to a properly grounded outlet. The instrument chassis is connected to the ground wire in the power cord.

The table below describes the power cord that is normally supplied with this instrument, depending on the destination region:

Destination Region	Description	Option	Manufacturer	Part Number
United Kingdom, Hong Kong, Singapore, Malaysia	BS 1363, 230V, 50 Hz	-AC00	Qualtek	370001-E01
Australia, New Zealand	AS 3112:2000, 230-240V, 50 Hz	-AC01	Qualtek	374003-A01
Continental Europe, Korea, Indonesia, Russia	European CEE 7/7 "Schuko" 230V, 50 Hz	-AC02	Qualtek	364002-D01
North America, Taiwan	NEMA 5-15, 120V, 60 Hz	-AC03	Qualtek	312007-01
Switzerland	SEV 1011, 230V, 50 Hz	-AC06	Qualtek	378001-E01
South Africa, India	SABS 164-1, 220-250V, 50 Hz	-AC17	Volex	2131H 10 C3
Japan	JIS 8303, 100V, 50-60 Hz	-AC18	Qualtek	397002-01
Israel	SI 32, 220V, 50 Hz	-AC19	Qualtek	398001-01
China	GB 1002-1, 220V, 50 Hz	-AC22	Volex	2137H 10 C3

PROTECTION FROM ELECTRIC SHOCK

 Operators of this instrument must be protected from electric shock at all times. The owner must ensure that operators are prevented access and/or are insulated from every connection point. In some cases, connections must be exposed to potential human contact. Operators must be trained to protect themselves from the risk of electric shock. This instrument is intended for use by qualified personnel who recognize shock hazards and are familiar with safety precautions required to avoid possibly injury. In particular, operators should:

1. Keep exposed high-voltage wiring to an absolute minimum.
2. Wherever possible, use shielded connectors and cabling.
3. Connect and disconnect loads and cables only when the instrument is turned off.
4. Keep in mind that all cables, connectors, oscilloscope probes, and loads must have an appropriate voltage rating.
5. Do not attempt any repairs on the instrument, beyond the fuse replacement procedures described in this manual. Contact Avtech technical support (see page 2 for contact information) if the instrument requires servicing. Service is to be performed solely by qualified service personnel.

ENVIRONMENTAL CONDITIONS

This instrument is intended for use under the following conditions:

1. indoor use;
2. altitude up to 2 000 m;
3. temperature 5 °C to 40 °C;
4. maximum relative humidity 80 % for temperatures up to 31 °C decreasing linearly to 50 % relative humidity at 40 °C;
5. Mains supply voltage fluctuations up to ± 10 % of the nominal voltage;
6. no pollution or only dry, non-conductive pollution.

FUSES

This instrument contains four fuses. All are accessible from the rear-panel. Two protect the AC prime power input, and two protect the internal DC power supplies. The locations of the fuses on the rear panel are shown in the figure below:

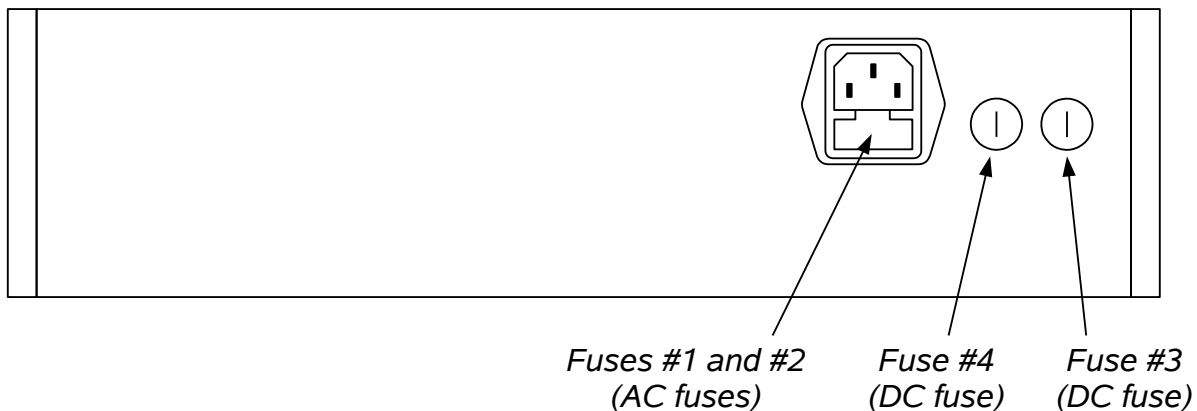

AC FUSE REPLACEMENT

To physically access the AC fuses, the power cord must be detached from the rear panel of the instrument. The fuse drawer may then be extracted using a small flat-head screwdriver, as shown below:

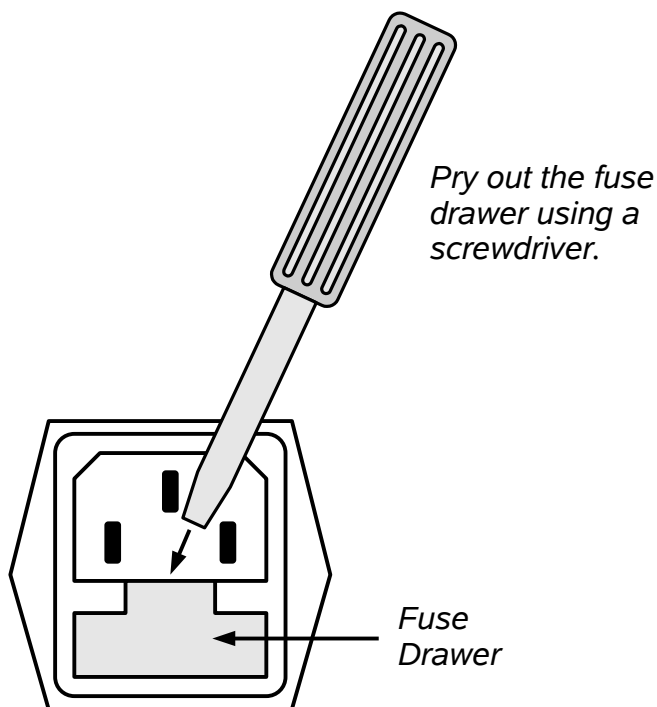

DC FUSE REPLACEMENT

The DC fuses may be replaced by inserting the tip of a flat-head screwdriver into the fuse holder slot, and rotating the slot counter-clockwise. The fuse and its carrier will then pop out.

FUSE RATINGS

The following table lists the required fuses:

Fuses	Nominal Mains Voltage	Rating	Case Size	Recommended Replacement Part	
				Littelfuse Part Number	Digi-Key Stock Number
#1, #2 (AC)	115 V	1.6A, 250V, Time-Delay	5×20 mm	021801.6HXP	F2424-ND
	230 V	0.8A, 250V, Time-Delay	5×20 mm	0218.800HXP	F2418-ND
#3 (DC)	N/A	1.0A, 250V, Time-Delay	5×20 mm	0218001.HXP	F2419-ND
#4 (DC)	N/A	5.0A, 250V, Time-Delay	5×20 mm	0218005.HXP	F2422-ND

The recommended fuse manufacturer is Littelfuse (<http://www.littelfuse.com>).

Replacement fuses may be easily obtained from Digi-Key (<http://www.digikey.com>) and other distributors.

FRONT PANEL CONTROLS

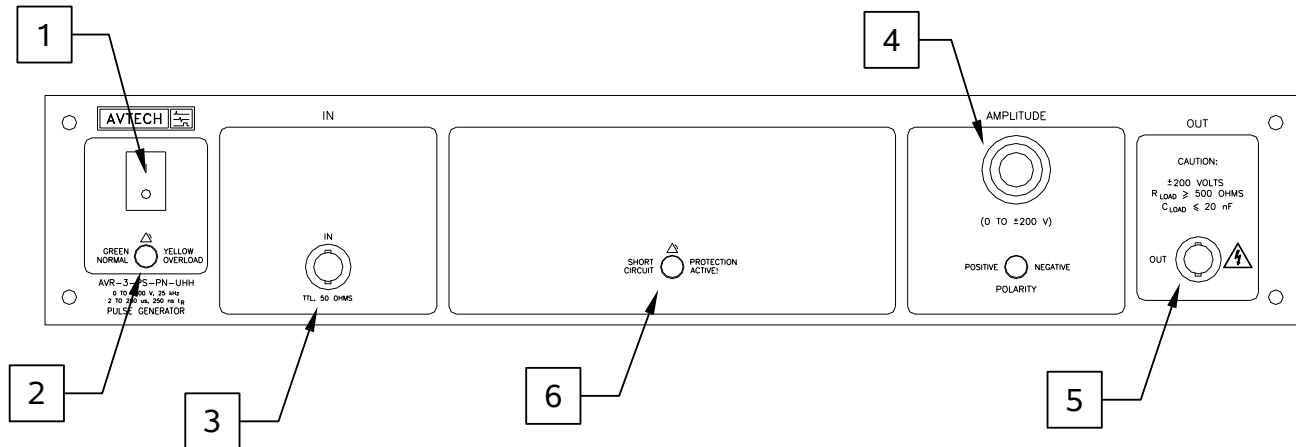

- 1) POWER Switch. This is the main power switch. When turning the instrument on, there may be a delay of several seconds before the instrument appears to respond.
- 2) OVERLOAD Indicator. When the instrument is powered, this indicator is normally green, indicating normal operation. If this indicator is yellow, an internal automatic overload protection circuit has been tripped. If the unit is overloaded (by operating at an exceedingly high duty cycle or by operating into a very low impedance), the protective circuit will disable the output of the instrument and turn the indicator light yellow. The light will stay yellow (i.e. output disabled) for about 5 seconds after which the instrument will attempt to re-enable the output (i.e. light green) for about 1 second. If the overload condition persists, the output will be disabled again (i.e. light yellow) for another 5 seconds. If the overload condition has been removed, the instrument will resume normal operation.

This overload indicator may flash yellow briefly at start-up. This is not a cause for concern.
- 3) IN Connector. The instrument is triggered by a TTL pulse applied to this connector. The pulse width must be in the range of 2 to 200 us, the pulse repetition frequency must be 25 kHz or less, and the duty cycle must be 57.5% or less. The input impedance is 50 Ohms. The output pulse width is approximately equal to the input pulse width.
- 4) AMPLITUDE Control. This dial controls the pulse amplitude.
- 5) OUT Connector. This connector provides the main output signal, into load resistances of 500Ω or higher, and/or capacitances of 20 nF or lower. The output pulse width is approximately equal to the input pulse width.
- 6) SHORT CIRCUIT Indicator. The main output is current-limited to 30 Amps, approximately. If the current limit is activated for a duration exceeding 5 us,

approximately, the output will be disabled for 3 seconds, and this indicator will light. The protective disabling will repeat as long as the over-current condition persists. The instrument will not be damaged by short circuits to ground on the output.

REAR PANEL CONTROLS

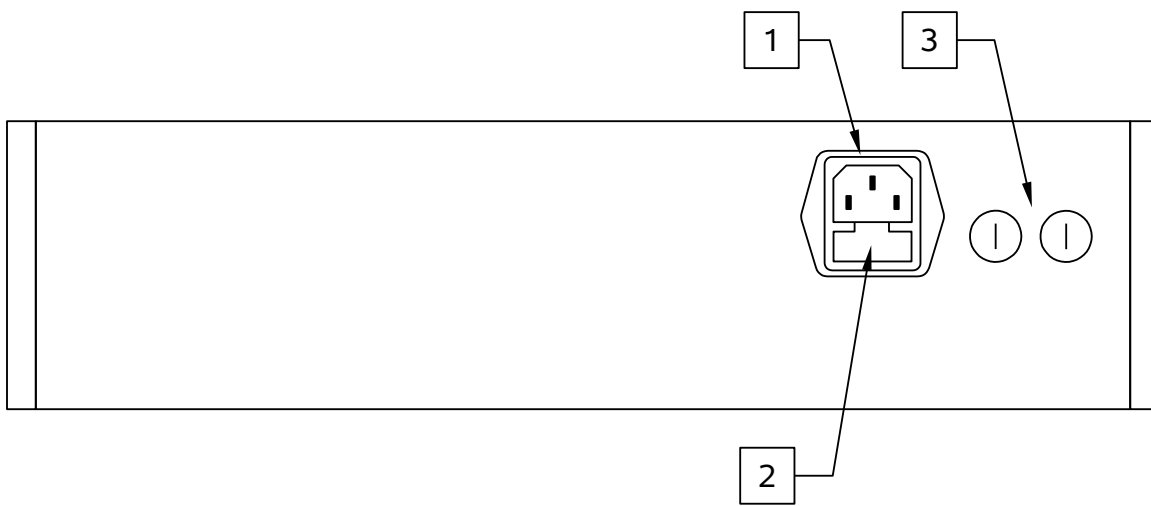

1. AC POWER INPUT. An IEC-320 C14 three-pronged recessed male socket is provided on the back panel for AC power connection to the instrument. One end of the detachable power cord that is supplied with the instrument plugs into this socket.
2. AC FUSE DRAWER. The two fuses that protect the AC input are located in this drawer. Please see the “FUSES” section of this manual for more information.
3. DC FUSES. These two fuses protect the internal DC power supplies. Please see the “FUSES” sections of this manual for more information.

GENERAL INFORMATION

BASIC TEST ARRANGEMENT

A typical test arrangement for the AVR-3-PS-PN-UHH is shown below. The load resistor must have a voltage rating of at least 200V. The power dissipated in the resistor is given by:

$$P = (V^2 / R) \times (PW / T) = (V^2 / R) \times PW \times f$$

where “V” is the output voltage, “R” is the load resistance, “PW” is the pulse width, and “T” is the pulse period (1/frequency), and “f” is the frequency. If a 500 Ω resistor is used, the worst-case power dissipation is approximately 66 Watts. Factory tests are conducted using twenty 10 kΩ, 2W resistors connected in parallel combination to make a 500Ω, 40W composite load. Fan cooling the resistors allows for slightly higher power dissipation. (Ohmite “OY” ceramic composition resistors - <http://www.ohmite.com> - are recommended for such applications. These resistors are readily available from <http://www.digi-key.com/> and other distributors.)

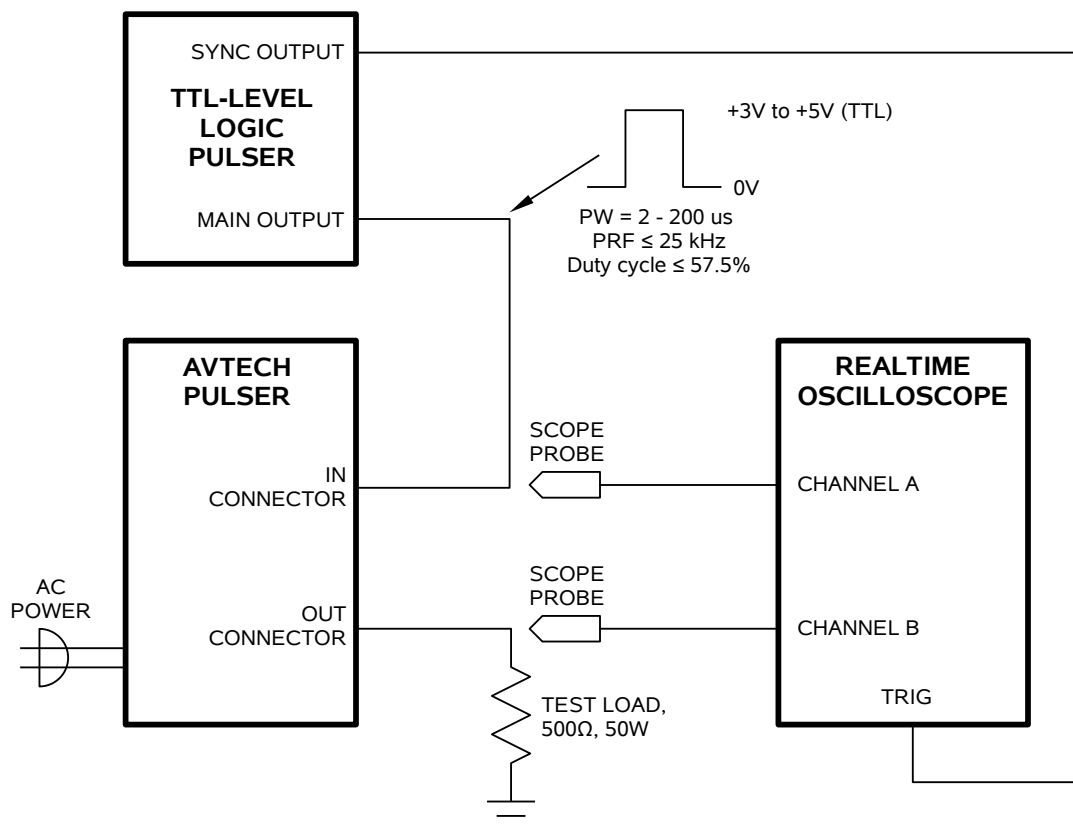

PROTECTING YOUR INSTRUMENT

TURN OFF INSTRUMENT WHEN NOT IN USE

The lifetime of the switching elements in the pulse generator module is proportional to the running time of the instrument. For this reason the prime power to the instrument should be turned off when the instrument is not in use. In the case of failure, the switching elements are easily replaced following the procedure described in a following section.

TURN OFF INSTRUMENT DURING SHORT CIRCUITS

A “Short Circuit” indicator is located near the output connector. If this indicator is lit, the load impedance is not correct. Turn off the instrument and correct the load condition.

(The output is designed to protect itself indefinitely under short circuit conditions, but for maximum instrument longevity, short circuit conditions should not be allowed to persist.)

DO NOT EXCEED 25 kHz

The output stage may be damaged if triggered by an external signal at a pulse repetition frequency greater than 25 kHz.

USE LOW-INDUCTANCE LOADS

Lenz’s Law predicts that for an inductive voltage spike will be generated when the current through an inductance changes. Specifically, $V_{\text{SPIKE}} = L \times dI_{\text{LOAD}}/dt$, where L is the inductance, I_{LOAD} is the load current change, and t is time. For this reason, it is important to keep any parasitic in the load low. This means keeping wiring short, and using low inductance components. In particular, wire-wound resistors should be avoided.

MECHANICAL INFORMATION

TOP COVER REMOVAL

If necessary, the interior of the instrument may be accessed by removing the four Phillips screws on the top panel. With the four screws removed, the top cover may be slid back (and off).

 Always disconnect the power cord and allow the instrument to sit unpowered for 10 minutes before opening the instrument. This will allow any internal stored charge to discharge.

There are no user-adjustable internal circuits. For repairs other than fuse replacement, please contact Avtech (info@avtechpulse.com) to arrange for the instrument to be returned to the factory for repair. Service is to be performed solely by qualified service personnel.

 Caution: High voltages are present inside the instrument during normal operation. Do not operate the instrument with the cover removed.

RACK MOUNTING

A rack mounting kit is available. The -R5 rack mount kit may be installed after first removing the one Phillips screw on the side panel adjacent to the front handle.

ELECTROMAGNETIC INTERFERENCE

To prevent electromagnetic interference with other equipment, all used outputs should be connected to shielded loads using shielded coaxial cables. Unused outputs should be terminated with shielded coaxial terminators or with shielded coaxial dust caps, to prevent unintentional electromagnetic radiation. All cords and cables should be less than 3m in length.

MAINTENANCE

REGULAR MAINTENANCE

This instrument does not require any regular maintenance.

On occasion, one or more of the four rear-panel fuses may require replacement. All fuses can be accessed from the rear panel. See the “FUSES” section for details.

CLEANING

If desired, the interior of the instrument may be cleaned using compressed air to dislodge any accumulated dust. (See the “TOP COVER REMOVAL” section for instructions on accessing the interior.) No other cleaning is recommended.

WIRING OF DC POWER

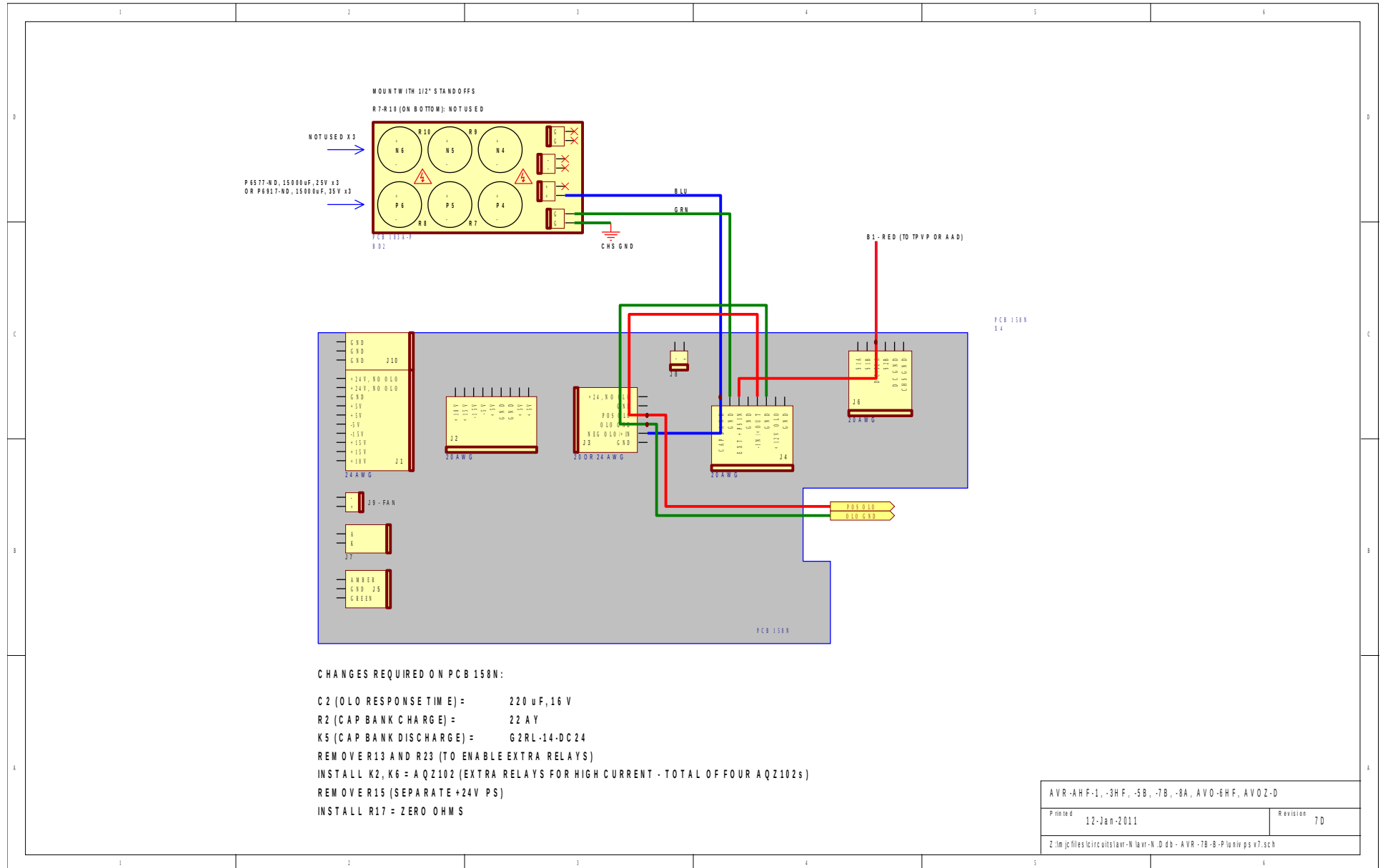

PCB 158N - LOW VOLTAGE POWER SUPPLY, 1/3

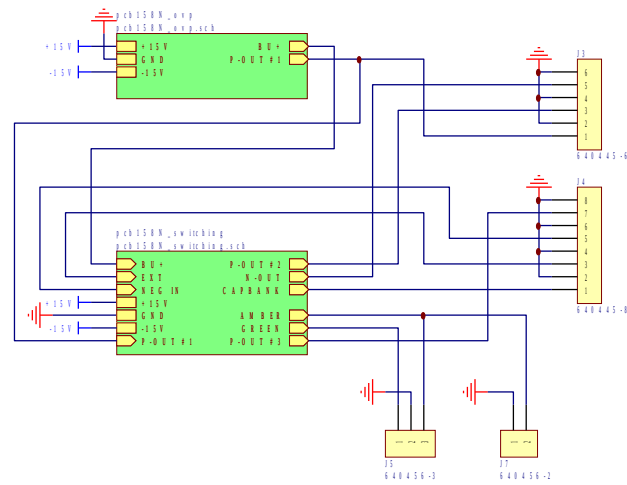

Title		LOW VOLTAGE DC/DC POWER SUPPLY
Date	12-Dec-2008	Revision
Z:\m\jcf\files\pcb158\switching\60hz.ddb - 158N\pcb158N.sch		

PCB 158N - LOW VOLTAGE POWER SUPPLY, 2/3

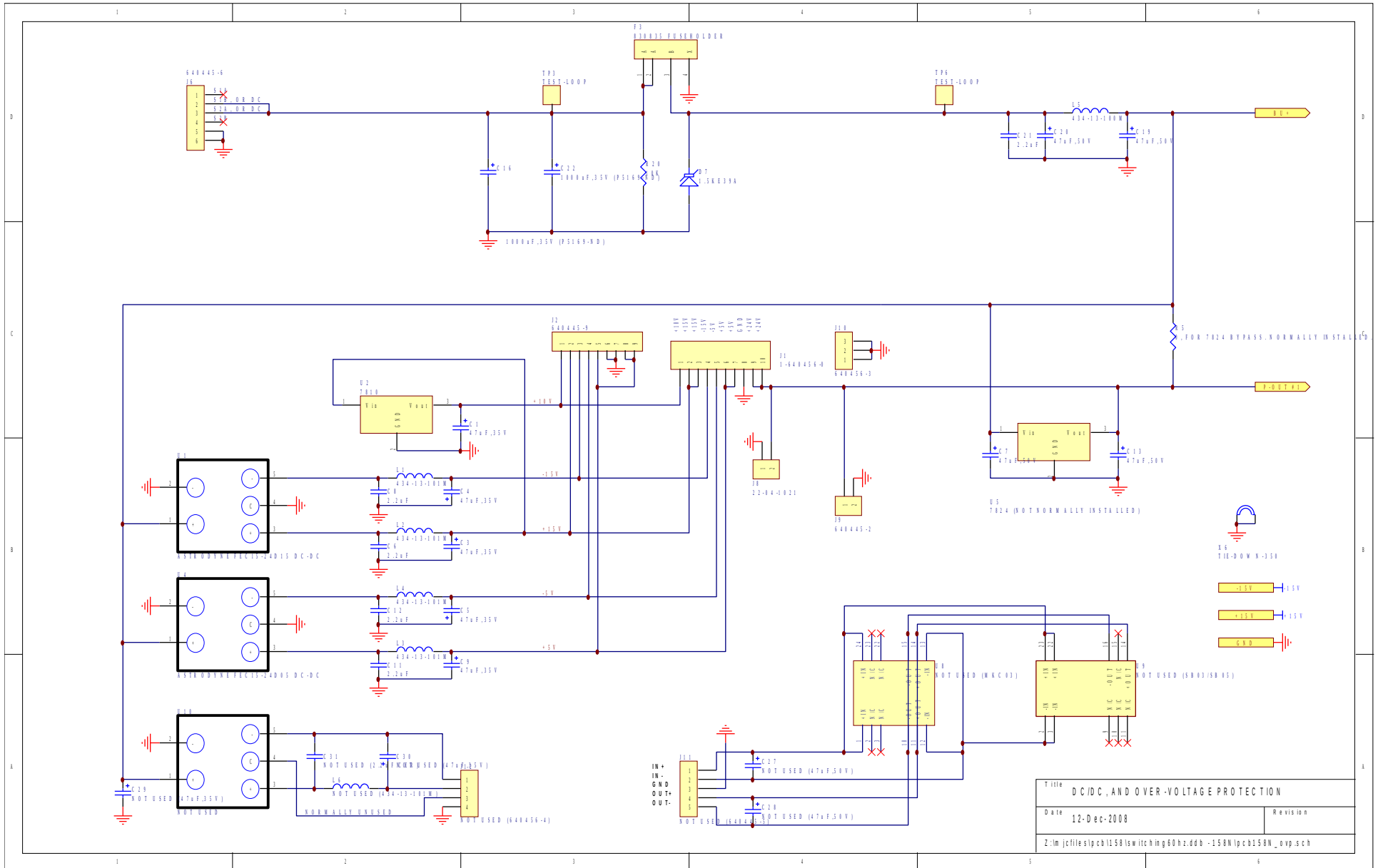

PCB 197A - HIGH VOLTAGE POWER SUPPLY PCB

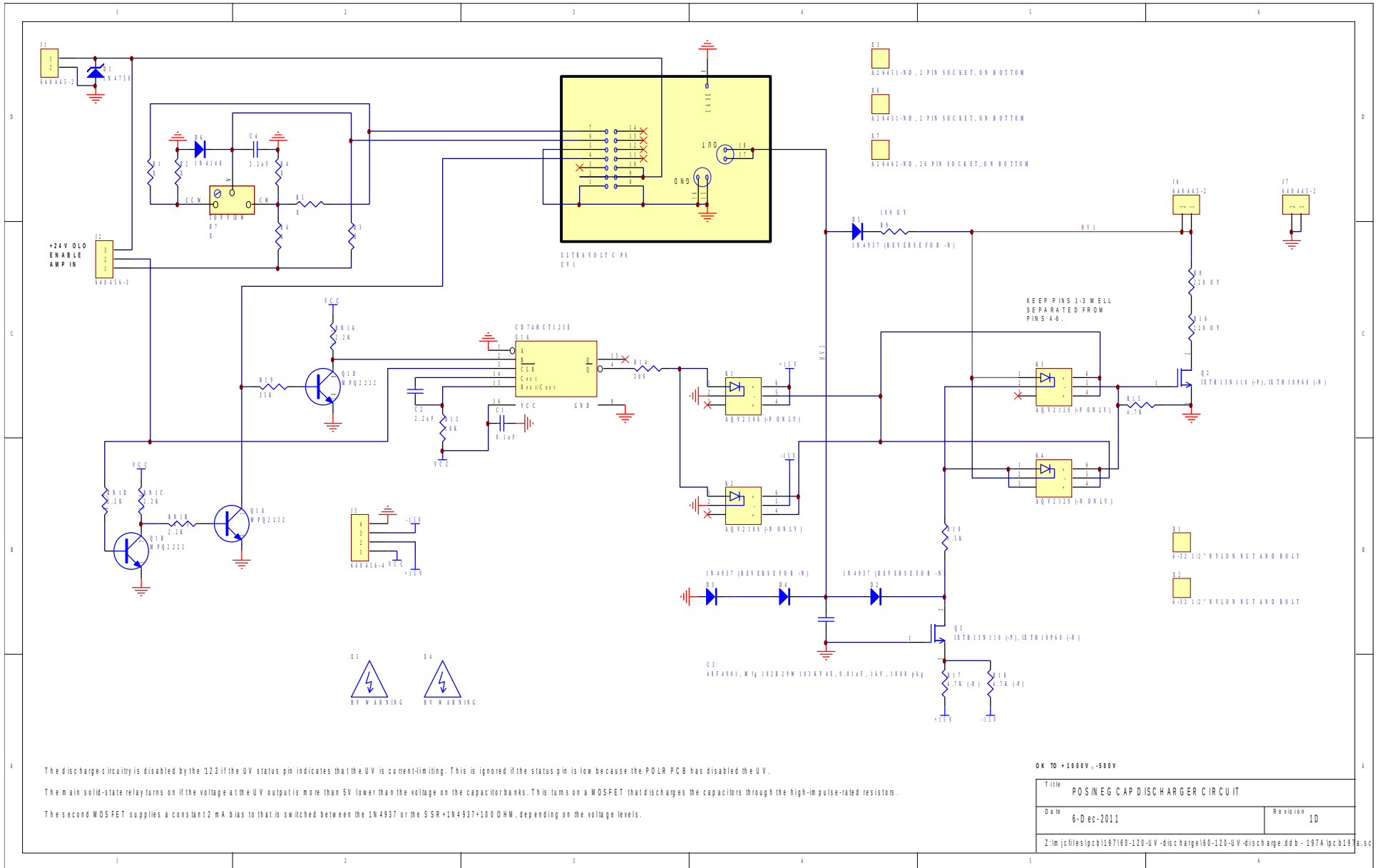

PCB 183A-S AND 183A-P CAPACITOR BANKS

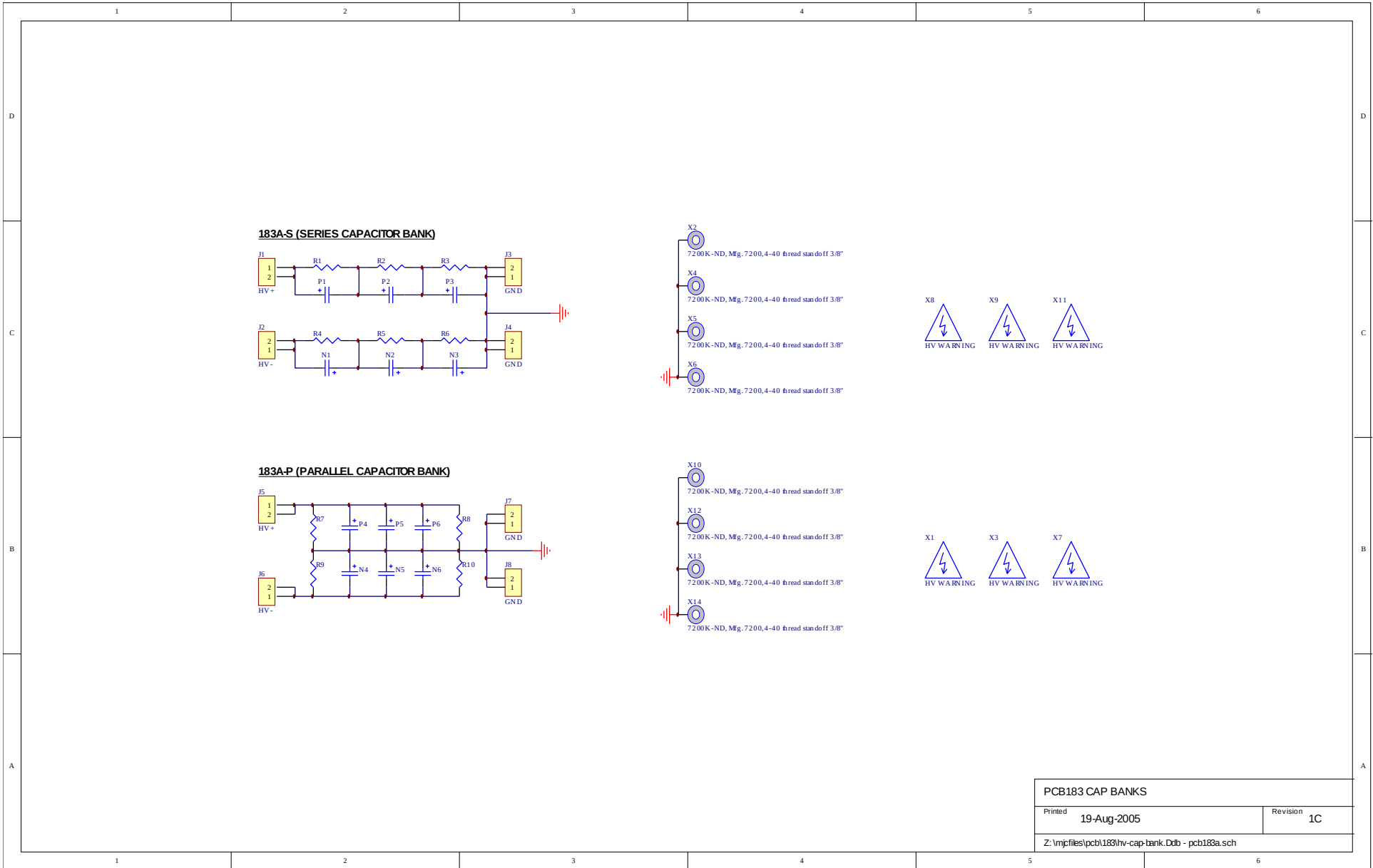

PCB183 CAP BANKS	
Printed 19-Aug-2005	Revision 1C
Z:\mjrfiles\pcb183\hv-cap-bank.Dtb - pcb183a.sch	

MAIN WIRING

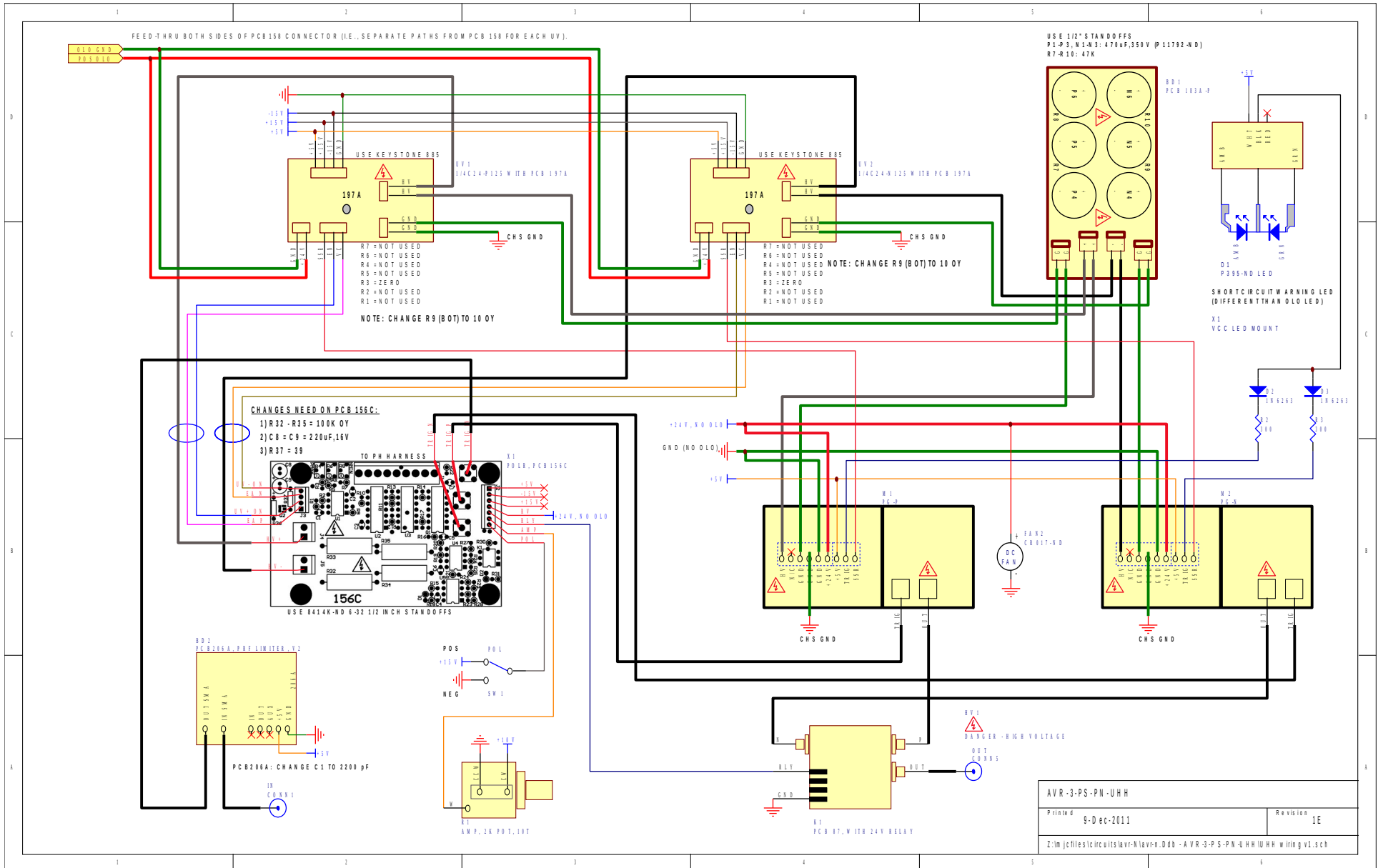

PERFORMANCE CHECK SHEET