



AVTECH ELECTROSYSTEMS LTD.

NANOSECOND WAVEFORM ELECTRONICS
SINCE 1975

P.O. BOX 265
OGDENSBURG, NY
U.S.A. 13669-0265
TEL: (315) 472-5270
FAX: (613) 226-2802

TEL: 1-800-265-6681
FAX: 1-800-561-1970

e-mail: info@avtechpulse.com
<http://www.avtechpulse.com/>

BOX 5120, LCD MERIVALE
OTTAWA, ONTARIO
CANADA K2C 3H4
TEL: (613) 226-5772
FAX: (613) 226-2802

INSTRUCTIONS

MODEL AVR-3-PW-C-P-TEK2

0 TO +250 VOLTS, 0 TO +5 AMPS
PULSE GENERATOR

SERIAL NUMBER: _____

WARRANTY

Avtech Electrosystems Ltd. warrants products of its manufacture to be free from defects in material and workmanship under conditions of normal use. If, within one year after delivery to the original owner, and after prepaid return by the original owner, this Avtech product is found to be defective, Avtech shall at its option repair or replace said defective item. This warranty does not apply to units which have been disassembled, modified or subjected to conditions exceeding the applicable specifications or ratings. This warranty is the extent of the obligation assumed by Avtech with respect to this product and no other warranty or guarantee is either expressed or implied.

TECHNICAL SUPPORT

Phone: 613-226-5772 or 1-800-265-6681

Fax: 613-226-2802 or 1-800-561-1970

E-mail: info@avtechpulse.com

World Wide Web: <http://www.avtechpulse.com>

TABLE OF CONTENTS

WARRANTY.....	2
TECHNICAL SUPPORT.....	2
TABLE OF CONTENTS.....	3
INTRODUCTION & SPECIFICATIONS.....	5
EC DECLARATION OF CONFORMITY.....	6
INSTALLATION.....	7
VISUAL CHECK.....	7
POWER RATINGS.....	7
CONNECTION TO THE POWER SUPPLY.....	7
ENVIRONMENTAL CONDITIONS.....	7
FUSES.....	8
AC FUSE REPLACEMENT.....	8
DC FUSE REPLACEMENT.....	9
FUSE RATINGS.....	9
FRONT PANEL CONTROLS.....	10
REAR PANEL CONTROLS.....	13
GENERAL INFORMATION.....	14
TEST ARRANGEMENT.....	14
SHORTING BAR.....	14
OTHER MECHANICAL INFORMATION.....	16
TOP COVER REMOVAL.....	16
RACK MOUNTING.....	16
ELECTROMAGNETIC INTERFERENCE.....	16
INTERNAL CONTROLS.....	16
MAINTENANCE.....	17
REGULAR MAINTENANCE.....	17
CLEANING.....	17
SYSTEM DESCRIPTION AND REPAIR PROCEDURE.....	18
REPAIR PROCEDURE - SWITCHING ELEMENTS.....	18
WIRING DIAGRAM.....	0
PERFORMANCE CHECK SHEET.....	0

Last modified February 29, 2024.
Copyright © 2024 Avtech Electrosystems Ltd, All Rights Reserved.

INTRODUCTION & SPECIFICATIONS

Model AVR-3-PW-C-P-TEK2 is a special order item which was custom designed for Tektronix, for the testing of current probes (such as the A6303 probe). Specifications are as follows:

Model designation:	AVR-3-PW-C-P-TEK2
Description:	<p>The AVR-3-PW-C-TEK2 generates a 10 ns rise time voltage pulse (0 to +250 Volts, 0.25 to 250 μs), which is accessible at the front panel OUT terminal. A shorting bar is connected between the OUT and IN terminals and the current probe is placed over the shorting bar. The IN terminal connects to ground via a 50 Ohm termination. A variable current of up to 5.0 Amperes is defined by the 250 Volt pulse and the 50-Ohm termination.</p> <p>For other applications, the OUT terminal may be used to pulse a user-supplied 50 Ohm load, if desired. In this case, the shorting bar and the "IN" terminal are not used.</p>
Output Amplitude:	0 to +250 Volts to $R_L \geq 50$ Ohms (ie 5 amperes peak current). Ten-turn locking dial control.
Output pulse width:	250 ns to 250 μ s. 3-position range switch and ten-turn fine control.
Output connectors:	Two SMA connectors. Output Shorting bar connects between two connectors. Tektronix probe clips over this shorting bar.
Rise, fall time:	≤ 10 ns
Max duty cycle:	0.25 % (eg PRF max 25 Hz for PW=250 μ s).
Overshoot at max output:	$\leq 5\%$
Droop (at max pulse width):	$\leq 2\%$
Chassis:	3.9" x 17" x 14.8"
Other:	See standard AVR-3-C, pages 43 and 44 Cat. No. 11

Model AVR-3-PW-C-TEK2 is modelled on our standard product model AVR-3-C-P (see Cat 11 pages 43 and 44 or <http://www.avtechpulse.com/speed/avr-3>).

This instrument is intended for use in research and development laboratories.

EC DECLARATION OF CONFORMITY

We

Avtech Electrosystems Ltd.
P.O. Box 5120, LCD Merivale
Ottawa, Ontario
Canada K2C 3H4

declare that this pulse generator meets the intent of Directive 89/336/EEC for Electromagnetic Compatibility. Compliance pertains to the following specifications as listed in the official Journal of the European Communities:

EN 50081-1 Emission

EN 50082-1 Immunity

and that this pulse generator meets the intent of the Low Voltage Directive 72/23/EEC as amended by 93/68/EEC. Compliance pertains to the following specifications as listed in the official Journal of the European Communities:

EN 61010-1:2001 Safety requirements for electrical equipment for measurement, control, and laboratory use



INSTALLATION

VISUAL CHECK

After unpacking the instrument, examine to ensure that it has not been damaged in shipment. Visually inspect all connectors, knobs, liquid crystal displays (LCDs), and the handles. Confirm that a power cord, a GPIB cable, and two instrumentation manuals (this manual and the “Programming Manual for -B Instruments”) are with the instrument. If the instrument has been damaged, file a claim immediately with the company that transported the instrument.

POWER RATINGS

This instrument is intended to operate from 100 - 240 V, 50 - 60 Hz.

The maximum power consumption is 57 Watts. Please see the “FUSES” section for information about the appropriate AC and DC fuses.

This instrument is an “Installation Category II” instrument, intended for operation from a normal single-phase supply.

CONNECTION TO THE POWER SUPPLY

An IEC-320 three-pronged recessed male socket is provided on the back panel for AC power connection to the instrument. One end of the detachable power cord that is supplied with the instrument plugs into this socket. The other end of the detachable power cord plugs into the local mains supply. Use only the cable supplied with the instrument. The mains supply must be earthed, and the cable used to connect the instrument to the mains supply must provide an earth connection. (The supplied cable does this.)

ENVIRONMENTAL CONDITIONS

This instrument is intended for use under the following conditions:

- indoor use;
- altitude up to 2 000 m;
- temperature 5 °C to 40 °C;
- maximum relative humidity 80 % for temperatures up to 31 °C decreasing linearly to 50 % relative humidity at 40 °C;
- Mains supply voltage fluctuations up to ± 10 % of the nominal voltage;
- no pollution or only dry, non-conductive pollution.

FUSES

This instrument contains four fuses. All are accessible from the rear-panel. Two protect the AC prime power input, and two protect the internal DC power supplies. The locations of the fuses on the rear panel are shown in the figure below:

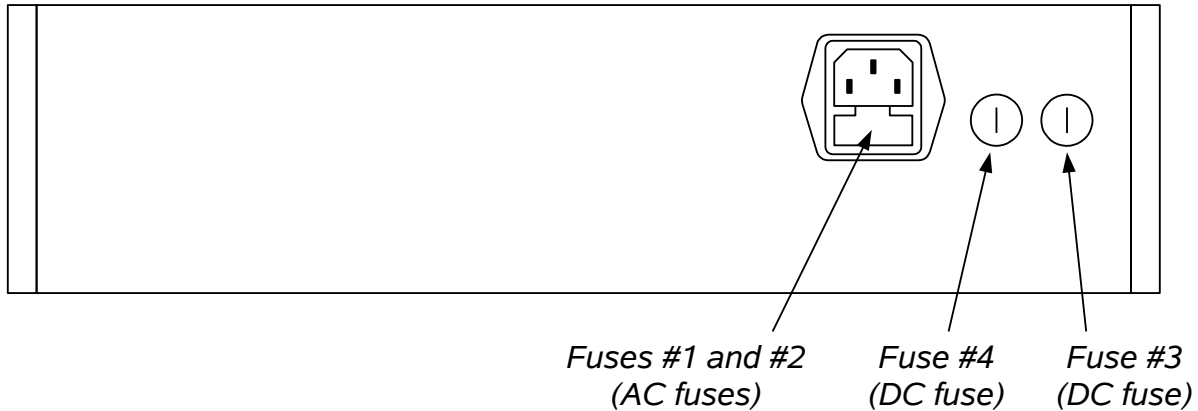

AC FUSE REPLACEMENT

To physically access the AC fuses, the power cord must be detached from the rear panel of the instrument. The fuse drawer may then be extracted using a small flat-head screwdriver, as shown below:

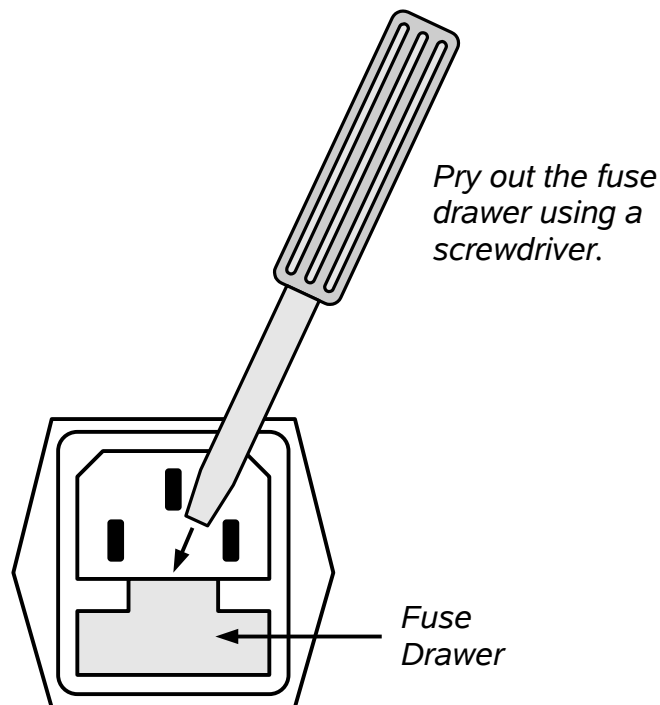

DC FUSE REPLACEMENT

The DC fuses may be replaced by inserting the tip of a flat-head screwdriver into the fuse holder slot, and rotating the slot counter-clockwise. The fuse and its carrier will then pop out.

FUSE RATINGS

The following table lists the required fuses:

Fuses	Nominal Mains Voltage	Rating	Case Size	Manufacturer's Part Number (Wickmann)	Distributor's Part Number (Digi-Key)
#1, #2 (AC)	100-240V	0.5A, 250V, Time-Delay	5×20 mm	1950500000	WK5041-ND
#3 (DC)	N/A	1.0A, 250V, Time-Delay	5×20 mm	1951100000	WK5048-ND
#4 (DC)	N/A	0.8A, 250V, Time-Delay	5×20 mm	1950800000	WK5046-ND

The fuse manufacturer is Wickmann (<http://www.wickmann.com/>).

Replacement fuses may be easily obtained from Digi-Key (<http://www.digikey.com/>) and other distributors.

FRONT PANEL CONTROLS

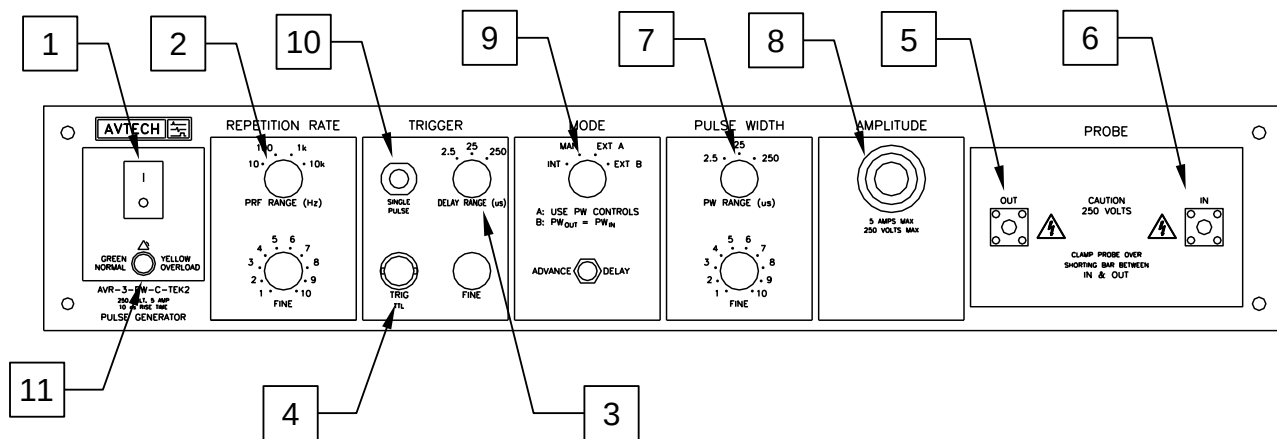

1. POWER Switch. This is the main power switch. When turning the instrument on, there may be a delay of several seconds before the instrument appears to respond.
2. REPETITION RATE Controls. When triggering internally, the range switch sets the pulse repetition frequency of the internal oscillator to one of four range:

RANGE 1	1 Hz - 10 Hz
RANGE 2	10 Hz - 100 Hz
RANGE 3	100 Hz - 1 kHz
RANGE 4	1 kHz - 10 kHz

The “FINE” knob varies the frequency within each range.

3. DELAY Control. Controls the relative delay between the reference output pulse provided at the TRIG output (4) and the main output (5). This delay is variable over the range of 0.25 to 250 us. The TRIG output precedes the main output when the ADVANCE-DELAY switch is in the ADVANCE position and lags when the switch is in the DELAY position.
4. TRIG Connector. When the MODE switch (item 8) is set to the “EXT” position, a TTL-level pulse applied to this connector will trigger the instrument. The instrument triggers on the rising edge of this input. The input impedance of this input is 1 k Ω . (Depending on the length of cable attached to this input, and the source driving it, it may be desirable to add a coaxial 50 Ohm terminator to this input to provide a proper transmission line termination. The Pasternack (www.pasternack.com) PE6008-50 BNC feed-thru 50 Ohm terminator is suggested for this purpose.)

When the MODE switch (item 8) is set to the “INT” position, this connector is used as an output that generates a 200 ns wide TTL-level pulse for each trigger event. This output can be used to trigger an oscilloscope, or other test equipment. The

separation between the main output pulse and the TRIG output pulse is controlled by the DELAY controls and the ADVANCE/DELAY switch. For this output to operate correctly, the delay setting must be less than the period.

5. OUT Connector. SMA connector provides 0 to +250 Volt output to a 50-Ohm load. (5) and (6) are normally connected together via the shorting bar, as discussed in later sections of this manual.

 Caution: Voltages as high as +250V may be present on the center conductor of this connector. Avoid touching this conductor. The center conductor is not user-accessible when the supplied shorting bar is installed.

6. IN Connector. This SMA input connects to the internal 50-Ohm load. (5) and (6) are normally connected together via the shorting bar, as discussed in later sections of this manual.

 Caution: Voltages as high as +250V may be present on the center conductor of this connector. Avoid touching this conductor. The center conductor is not user-accessible when the supplied shorting bar is installed.

7. PW Control. A one-turn knob and three-position range switch vary the output pulse width from 0.25 us to 250 us. The minimum and maximum pulse width (PW) for each range and the corresponding maximum pulse repetition frequency (PRF) are as follows. Note that the unit may fail if operated at duty cycles exceeding 0.25%.

	<u>PW min</u>	<u>PW max</u>
<u>Range 1</u> (PRF max)	0.25 us (10 kHz)	2.5 us (2.5 kHz)
<u>Range 2</u> (PRF max)	2.5 us (2.5 kHz)	25 us (250 Hz)
<u>Range 3</u> (PRF max)	25 us (250 Hz)	250 us (25 Hz)

8. AMP Control. This ten-turn locking dial varies the output pulse amplitude from 0 to +250 Volts (to 50 Ohms).
9. INT/MAN/EXT A/EXT B Mode Switch. With this switch in the INT position, the repetition rate of the unit is controlled by an internal oscillator, which in turn is controlled by the REPETITION RATE controls.

With the switch in the EXT A position, the unit requires a 50 ns (or wider) TTL level pulse applied at the TRIG input in order to trigger the output stages. The output pulse width is set by the front-panel controls in this mode.

With the switch in the EXT B position, the unit requires a 0.25-250 us wide TTL level pulse applied at the TRIG input in order to trigger the output stages. The output pulse width is equal to the input pulse width in this mode.

For a single pulse output, the switch should be in the “MAN” position and then push the SINGLE PULSE pushbutton (10).

10. SINGLE PULSE Pushbutton. When the INT/MAN/EXT A/EXT B switch is in the “MAN” position, the instrument can be triggered by pressing this pushbutton. A single pulse is generated for each button press.
11. OVERLOAD Indicator. When the instrument is powered, this indicator is normally green, indicating normal operation. If this indicator is yellow, an internal automatic overload protection circuit has been tripped. If the unit is overloaded (by operating at an exceedingly high duty cycle or by operating into a very low impedance), the protective circuit will disable the output of the instrument and turn the indicator light yellow. The light will stay yellow (i.e. output disabled) for about 5 seconds after which the instrument will attempt to re-enable the output (i.e. light green) for about 1 second. If the overload condition persists, the output will be disabled again (i.e. light yellow) for another 5 seconds. If the overload condition has been removed, the instrument will resume normal operation.

This overload indicator may flash yellow briefly at start-up. This is not a cause for concern.

Overload conditions may be removed by:

- Reducing repetition rate
- Reducing pulse width
- Increasing the load impedance
- Reducing the output amplitude

REAR PANEL CONTROLS

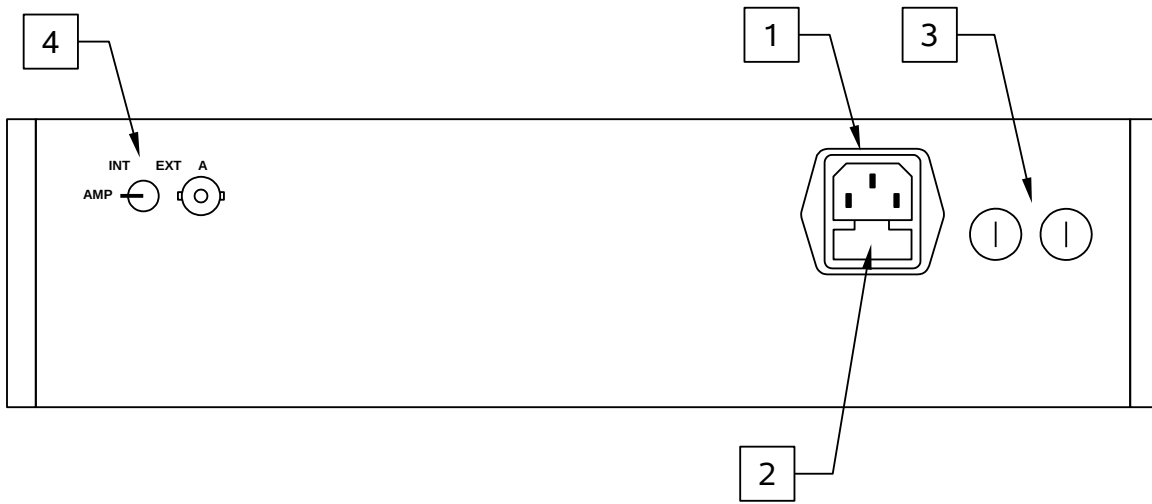

1. AC POWER INPUT. An IEC-320 C14 three-pronged recessed male socket is provided on the back panel for AC power connection to the instrument. One end of the detachable power cord that is supplied with the instrument plugs into this socket.
2. AC FUSE DRAWER. The two fuses that protect the AC input are located in this drawer. Please see the “FUSES” section of this manual for more information.
3. DC FUSES. These two fuses protect the internal DC power supplies. Please see the “FUSES” sections of this manual for more information.
4. EA SWITCH AND INPUT. When this switch is set to the “INT” position, the output amplitude is controlled by the front-panel amplitude dial. When this switch is set to the “EXT” position, the output amplitude is controlled by the voltage applied to the “A” BNC connector. 0V in corresponds to zero amplitude, and +10V DC in corresponds to maximum amplitude (+250V). The input impedance of the “A” connector is $> 10\text{ k}\Omega$.

GENERAL INFORMATION

TEST ARRANGEMENT

The AVR-3-PW-C-TEK2 generates a 10 ns rise time voltage pulse (0 to +250 Volts, 0.25 to 250 μ s), which is accessible at the front panel OUT terminal. A shorting bar is connected between the OUT and IN terminals and the current probe is placed over the shorting bar. The IN terminal connects to ground via a 50 Ohm termination. A variable current of up to 5.0 Amperes is defined by the 250 Volt pulse and the 50-Ohm termination. The basic test arrangement is illustrated below:

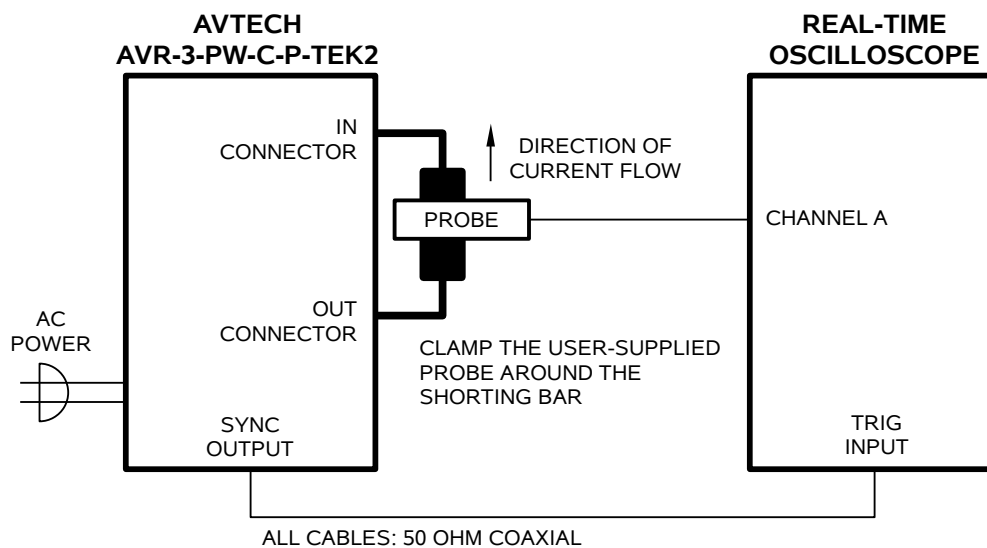

For other applications, the OUT terminal may be used to pulse a user-supplied 50 Ohm load, if desired. In this case, the shorting bar and the “IN” terminal are not used.

SHORTING BAR

The shorting bar allows a Tektronix current probe to be clamped around it. The current bar is reversible; it may be installed in either orientation. A photo of the shorting bar is shown below:



The next photo shows the shorting bar installed, with a Tektronix A6303 current probe clamped to it. Note that the probe is upside-down, in order for the probe to sense a positive current.

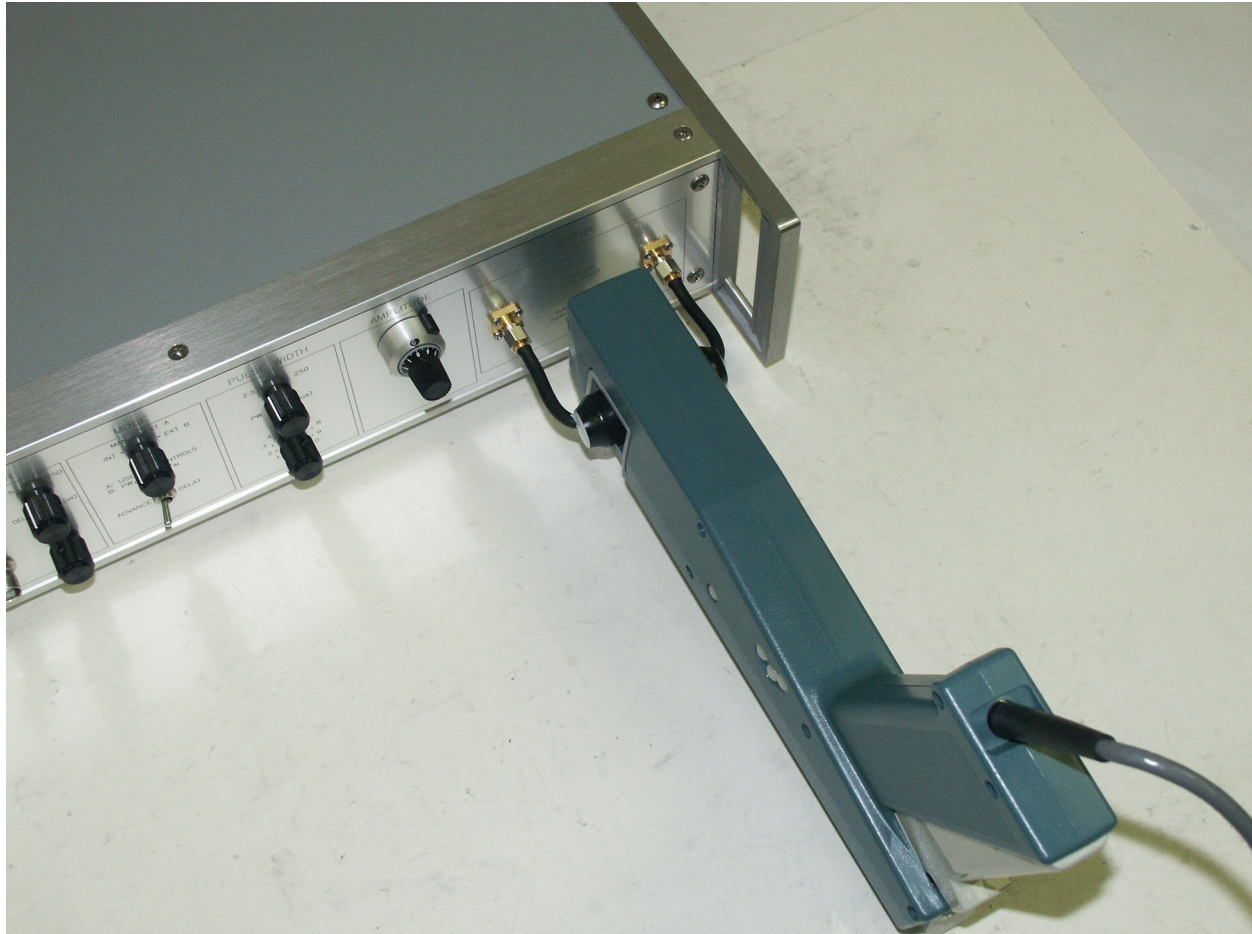

OTHER MECHANICAL INFORMATION

TOP COVER REMOVAL

If necessary, the interior of the instrument may be accessed by removing the four Phillips screws on the top panel. With the four screws removed, the top cover may be slid back (and off).

Always disconnect the power cord before opening the instrument.

There are no user-adjustable internal circuits. For repairs other than fuse replacement, please contact Avtech (info@avtechpulse.com) to arrange for the instrument to be returned to the factory for repair.

 Caution: High voltages are present inside the instrument during normal operation. Do not operate the instrument with the cover removed.

RACK MOUNTING

A rack mounting kit is available. The -R5 rack mount kit may be installed after first removing the one Phillips screw on the side panel adjacent to the front handle.

ELECTROMAGNETIC INTERFERENCE

To prevent electromagnetic interference with other equipment, all used outputs should be connected to shielded 50Ω loads using shielded 50Ω coaxial cables. Unused outputs should be terminated with shielded 50Ω terminators or with shielded dust caps, to prevent unintentional electromagnetic radiation. All cords and cables should be less than 3m in length.

INTERNAL CONTROLS

Other than certain fuses described later in this manual, there are no controls inside the instrument affecting the normal operation of the instrument. (Earlier versions of this instrument had a “HIGH-LOW capacitor switch”. Design improvements have allowed removal of this switch.)

MAINTENANCE

REGULAR MAINTENANCE

This instrument does not require any regular maintenance.

On occasion, one or more of the four rear-panel fuses may require replacement. All fuses can be accessed from the rear panel. See the “FUSES” section for details.

CLEANING

If desired, the interior of the instrument may be cleaned using compressed air to dislodge any accumulated dust. (See the “TOP COVER REMOVAL” section for instructions on accessing the interior.) No other cleaning is recommended.

SYSTEM DESCRIPTION AND REPAIR PROCEDURE

The AVR-3-PW-C-P-TEK2 consists of the following basic modules:

- 1) "PCBM - PCB 152" timing circuit board
- 2) "AVR-3-PW-P-TEK2-PG" pulse generator module
- 3) "AVR-3-TEK2-50" internal load
- 4) "1/4A24-P20" high voltage power supply
- 5) "PS 158D" 60 Hz power supply
- 6) "PCB 157" high-voltage discharge circuit

These circuits are interconnected as shown in the following wiring diagram. The "PCBM - PCB 152" timing circuit board generates the TTL-level trigger pulse that drives the "AVR-3-PW-P-TEK2-PG" pulse generator module. The pulse width of this TTL-level trigger pulse controls the pulse width of the output pulse.

The "AVR-3-PW-P-TEK2-PG" pulse generator module generates the main output pulse. The amplitude of this pulse is controlled by the "1/4A24-P20" high voltage power supply. The DC output voltage of the "1/4A24-P20" high voltage power supply is approximately equal to the output pulse amplitude.

The "1/4A24-P20" high voltage power supply is powered from a +24V DC voltage. The current on this +24V supply is monitored by the "PS 158D" power supply. If the average current exceeds a set limit, the "PS 158D" will remove the +24V DC supply from the "1/4A24-P20" high voltage power supply.

A large energy storage capacitor (470uF, 250V) is connected to the output of the "1/4A24-P20" high voltage power supply. The "PCB 157" high-voltage discharge circuit ensures that the voltage on this capacitor is discharged rapidly when the user lowers the set amplitude.

The +24V supply, as well as the other main DC power supply voltages, is generated by the "PS 158D" 60 Hz power supply.

The "AVR-3-TEK2-50" internal load is a precision 50 Ohm power resistor.

REPAIR PROCEDURE - SWITCHING ELEMENTS

The switching elements may be accessed by removing the cover plate on the bottom side of the instrument. **NOTE:** First turn off the prime power. The elements may be removed from their sockets by means of a needle nosed pliers. The SL4AT is a selected VMOS power transistor in a TO-220 packages and may be checked on a curve tracer. If defective, replacement units should be ordered directly from Avtech. When replacing the SL4AT switching elements, take care to insure that the short lead (of the three leads) is adjacent to the black dot on the chassis.

PERFORMANCE CHECK SHEET