



AVTECH ELECTROSYSTEMS LTD.

NANOSECOND WAVEFORM ELECTRONICS
SINCE 1975

P.O. BOX 265
OGDENSBURG, NY
U.S.A. 13669-0265
TEL: (315) 472-5270
FAX: (613) 226-2802

TEL: 1-800-265-6681
FAX: 1-800-561-1970

e-mail: info@avtechpulse.com
<http://www.avtechpulse.com/>

BOX 5120, LCD MERIVALE
OTTAWA, ONTARIO
CANADA K2C 3H4
TEL: (613) 226-5772
FAX: (613) 226-2802

INSTRUCTIONS

MODEL AVR-E2-B

0 TO 50 VOLTS, 500 ps RISE & FALL TIME
HIGH PERFORMANCE PULSE GENERATOR
WITH IEEE 488.2 AND RS-232 CONTROL

SERIAL NUMBER: _____

WARRANTY

Avtech Electrosystems Ltd. warrants products of its manufacture to be free from defects in material and workmanship under conditions of normal use. If, within one year after delivery to the original owner, and after prepaid return by the original owner, this Avtech product is found to be defective, Avtech shall at its option repair or replace said defective item. This warranty does not apply to units which have been disassembled, modified or subjected to conditions exceeding the applicable specifications or ratings. This warranty is the extent of the obligation assumed by Avtech with respect to this product and no other warranty or guarantee is either expressed or implied.

TECHNICAL SUPPORT

Phone: 613-226-5772 or 1-800-265-6681

Fax: 613-226-2802 or 1-800-561-1970

E-mail: info@avtechpulse.com

World Wide Web: <http://www.avtechpulse.com>

TABLE OF CONTENTS

WARRANTY.....	2
TECHNICAL SUPPORT.....	2
TABLE OF CONTENTS.....	3
INTRODUCTION.....	5
AVAILABLE OPTIONS.....	5
SPECIFICATIONS.....	6
EC DECLARATION OF CONFORMITY.....	7
INSTALLATION.....	8
VISUAL CHECK.....	8
POWER RATINGS.....	8
CONNECTION TO THE POWER SUPPLY.....	8
ENVIRONMENTAL CONDITIONS.....	8
LABVIEW DRIVERS.....	9
FUSES.....	10
AC FUSE REPLACEMENT.....	10
DC FUSE REPLACEMENT.....	11
FUSE RATINGS.....	11
FRONT PANEL CONTROLS.....	12
REAR PANEL CONTROLS.....	14
GENERAL INFORMATION.....	16
BASIC PULSE CONTROL.....	16
TRIGGER MODES.....	17
GATING MODES.....	18
AMPLITUDE DYNAMIC RANGE.....	18
OPTIONAL FEATURES.....	19
DC OFFSET, "-OS" OPTION.....	19
MONITOR OUTPUT, "-M" OPTION.....	19
ELECTRONIC AMPLITUDE CONTROL, "-EA" OPTION.....	19
PROTECTING YOUR INSTRUMENT.....	20
TURN OFF INSTRUMENT WHEN NOT IN USE.....	20
DO NOT EXCEED 100 kHz.....	20
USE A 50 OHM LOAD.....	20

OPERATIONAL CHECK.....	21
MECHANICAL INFORMATION.....	24
TOP COVER REMOVAL.....	24
RACK MOUNTING.....	24
ELECTROMAGNETIC INTERFERENCE.....	24
MAINTENANCE.....	25
REGULAR MAINTENANCE.....	25
CLEANING.....	25
PROGRAMMING YOUR PULSE GENERATOR.....	26
KEY PROGRAMMING COMMANDS.....	26
ALL PROGRAMMING COMMANDS.....	27
PERFORMANCE CHECKSHEET.....	29

Manual Reference: /fileserv1/officefiles/instructword/avr-e/OBS/avr-e2-b,edition2.sxw.
Last modified February 29, 2024.
Copyright © 2003 Avtech Electrosystems Ltd, All Rights Reserved.

INTRODUCTION

The AVR-E2-B is a high performance, GPIB and RS232-equipped instrument capable of generating 50V into 50 Ω loads. The output pulse width is variable from 20 ns to 200 ns, at repetition rates up to 100 kHz. (Models with the -W option have an output pulse width variable from 50 ns to 5 us, at repetition rates up to 10 kHz.) The rise and fall times are fixed at less than 500 ps.

Instruments with the "-P" model suffix can generate 0 to +50V, whereas instruments with the "-N" model suffix can generate 0 to -50V. Instruments with the "-PN" suffix can generate both polarities.

The AVR-E2-B is a highly flexible instrument. Aside from the internal trigger source, it can also be triggered or gated by external TTL-level signals. A front-panel pushbutton or a computer command can also be used to trigger the instrument.

The AVR-E2-B features front panel keyboard and adjust knob control of the output pulse parameters along with a four line by 40 character back-lit LCD display of the output amplitude, pulse width, pulse repetition frequency, and delay. The instrument includes memory to store up to four complete instrument setups. The operator may use the front panel or the computer interface to store a complete "snapshot" of all key instrument settings, and recall this setup at a later time.

This instrument is intended for use in research and development laboratories.

AVAILABLE OPTIONS

The AVR-E2-B is available with several options:

-EA Option: the amplitude can be controlled by an externally generated 0 to +10V analog control voltage.

-M Option: a monitor output is provided.

-OS Option: an externally generated DC offset can be added to the output.

-R5 Option: This is the optional rack-mounting kit. The R5 rack-mount kit may also be ordered separately.

-W Option: The pulse width range is changed to 50 ns to 5 us. The maximum pulse repetition frequency falls to 10 kHz.

SPECIFICATIONS

Model:	AVR-E2-B ²
GPIB and RS-232 control ² :	Standard on -B units
Amplitude ^{3,4} : (50 Ohm load)	0 to 50 Volts
Rise time (20%-80%):	0.5 ns
Fall time (80%-20%):	0.5 ns
Pulse width ^{3,5} : standard units:	20 ns to 0.2 us
for units with -W option:	50 ns to 5 us ⁵
PRF: standard units:	0 to 100 kHz
for units with -W option:	0 to 10 kHz
Polarity ⁶ :	Positive or negative or both (specify ⁶)
Propagation delay:	≤ 160 ns (Ext trig in to pulse out)
Jitter: (Ext trig in to pulse out)	± 35ps ± 0.015% of sync delay
DC offset or bias insertion:	Option available. Apply required DC offset or bias in the range of ±25 Volts, (250 mA max) to back panel solder terminals. See note 7.
Trigger required:	Ext trig mode: + 5 Volts, 10 ns or wider (TTL)
Sync delay:	Variable 0 to ± 1 second
Sync output:	+ 3 Volts, 200 ns, will drive 50 Ohm loads
Gate input:	Synchronous or asynchronous, active high or low, switchable. Suppresses triggering when active.
Connectors:	Out: SMA, Trig, Sync, Gate: BNC
Power requirements:	100 - 240 Volts, 50 - 60 Hz
Dimensions (H x W x D):	100 mm x 430 mm x 375 mm (3.9" x 17" x 14.8")
Chassis material:	cast aluminum frame and handles, blue vinyl on aluminum cover plates
Mounting:	Any
Temperature range:	+5°C to +40°C

- 1) -C suffix indicates stand-alone lab instrument with internal clock and line powering.
- 2) -B suffix indicates IEEE-488.2 GPIB and RS-232 control of amplitude, pulse width, PRF and delay.
- 3) For electronic control (0 to + 10 V) of amplitude or pulse width, suffix model number with -EA or -EW. Electronic control units also include the standard front-panel controls. -EW available on -C units only.
- 4) For operation at amplitudes of less than 10% of full-scale, best results will be obtained by setting the amplitude near full-scale and using external attenuators on the output.
- 5) For 50 ns to 5 us range suffix model number with -W.
- 6) Indicate desired polarity by suffixing model number with -P or -N (i.e. positive or negative) or -PN for dual polarity option. Polarity reversal achieved by means of a two-position switch that controls the polarity of the signal output port on -C units, and via keypad control on -B units.
- 7) For DC offset option suffix model number with -OS.
- 8) Maximum duty cycle is 1% (e.g. at 5 kHz the maximum pulse width is 2us).

EC DECLARATION OF CONFORMITY

We

Avtech Electrosystems Ltd.
P.O. Box 5120, LCD Merivale
Ottawa, Ontario
Canada K2C 3H4

declare that this pulse generator meets the intent of Directive 89/336/EEC for Electromagnetic Compatibility. Compliance pertains to the following specifications as listed in the official Journal of the European Communities:

EN 50081-1 Emission

EN 50082-1 Immunity

and that this pulse generator meets the intent of the Low Voltage Directive 72/23/EEC as amended by 93/68/EEC. Compliance pertains to the following specifications as listed in the official Journal of the European Communities:

EN 61010-1:2001 Safety requirements for electrical equipment for measurement, control, and laboratory use



INSTALLATION

VISUAL CHECK

After unpacking the instrument, examine to ensure that it has not been damaged in shipment. Visually inspect all connectors, knobs, liquid crystal displays (LCDs), and the handles. Confirm that a power cord, a GPIB cable, and two instrumentation manuals (this manual and the “Programming Manual for -B Instruments”) are with the instrument. If the instrument has been damaged, file a claim immediately with the company that transported the instrument.

POWER RATINGS

This instrument is intended to operate from 100 - 240 V, 50 - 60 Hz.

The maximum power consumption is 57 Watts. Please see the “FUSES” section for information about the appropriate AC and DC fuses.

This instrument is an “Installation Category II” instrument, intended for operation from a normal single-phase supply.

CONNECTION TO THE POWER SUPPLY

An IEC-320 three-pronged recessed male socket is provided on the back panel for AC power connection to the instrument. One end of the detachable power cord that is supplied with the instrument plugs into this socket. The other end of the detachable power cord plugs into the local mains supply. Use only the cable supplied with the instrument. The mains supply must be earthed, and the cable used to connect the instrument to the mains supply must provide an earth connection. (The supplied cable does this.)

ENVIRONMENTAL CONDITIONS

This instrument is intended for use under the following conditions:

1. indoor use;
2. altitude up to 2 000 m;
3. temperature 5 °C to 40 °C;
4. maximum relative humidity 80 % for temperatures up to 31 °C decreasing linearly to 50 % relative humidity at 40 °C;
5. Mains supply voltage fluctuations up to ± 10 % of the nominal voltage;
6. no pollution or only dry, non-conductive pollution.

LABVIEW DRIVERS

A LabVIEW driver for this instrument is available for download on the Avtech web site, at <http://www.avtechpulse.com/labview>. A copy is also available in National Instruments' Instrument Driver Library at <http://www.natinst.com/>.

FUSES

This instrument contains four fuses. All are accessible from the rear-panel. Two protect the AC prime power input, and two protect the internal DC power supplies. The locations of the fuses on the rear panel are shown in the figure below:

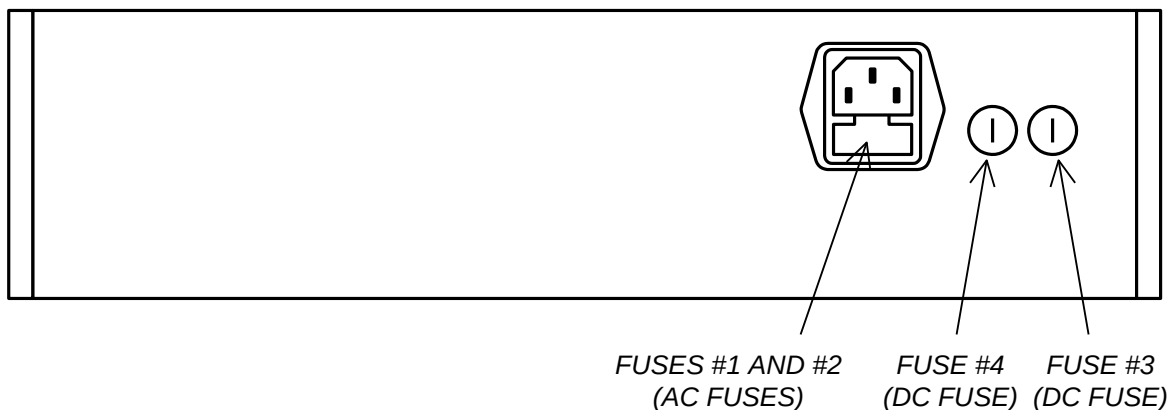

AC FUSE REPLACEMENT

To physically access the AC fuses, the power cord must be detached from the rear panel of the instrument. The fuse drawer may then be extracted using a small flat-head screwdriver, as shown below:

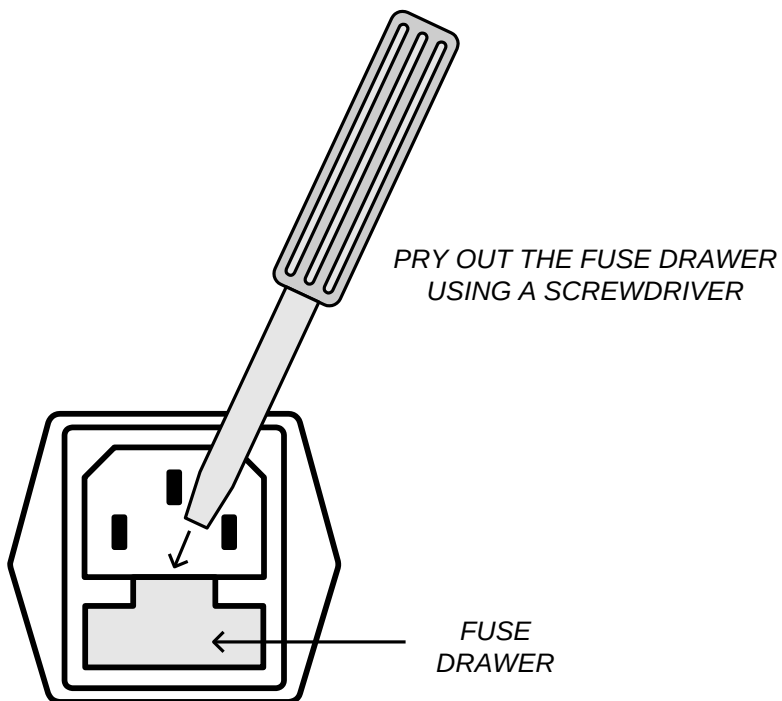

DC FUSE REPLACEMENT

The DC fuses may be replaced by inserting the tip of a flat-head screwdriver into the fuse holder slot, and rotating the slot counter-clockwise. The fuse and its carrier will then pop out.

FUSE RATINGS

The following table lists the required fuses:

Fuses	Rating	Case Size	Manufacturer's Part Number (Wickmann)	Distributor's Part Number (Digi-Key)
#1, #2 (AC)	0.5A, 250V, Time-Delay	5 x 20 mm	1950500000	WK5041-ND
#3 (DC)	1.0A, 250V, Time-Delay	5 x 20 mm	1951100000	WK5048-ND
#4 (DC)	0.5A, 250V, Time-Delay	5 x 20 mm	1950500000	WK5041-ND

The fuse manufacturer is Wickmann (<http://www.wickmann.com/>).

Replacement fuses may be easily obtained from Digi-Key (<http://www.digikey.com/>) and other distributors.

FRONT PANEL CONTROLS

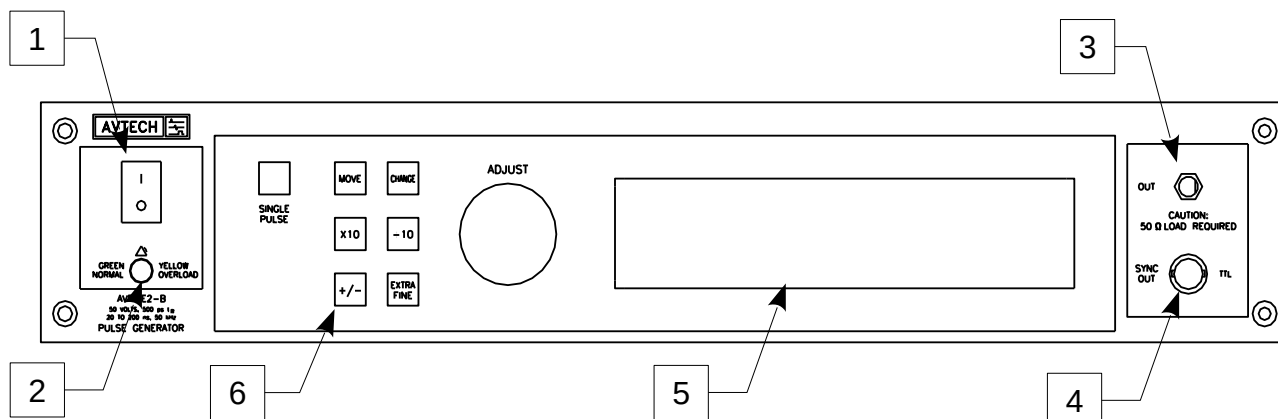

1. POWER Switch. This is the main power switch. When turning the instrument on, there may be a delay of several seconds before the instrument appears to respond.
2. OVERLOAD Indicator. When the instrument is powered, this indicator is normally green, indicating normal operation. If this indicator is yellow, an internal automatic overload protection circuit has been tripped. If the unit is overloaded (by operating at an exceedingly high duty cycle or by operating into a very low impedance), the protective circuit will disable the output of the instrument and turn the indicator light yellow. The light will stay yellow (i.e. output disabled) for about 5 seconds after which the instrument will attempt to re-enable the output (i.e. light green) for about 1 second. If the overload condition persists, the output will be disabled again (i.e. light yellow) for another 5 seconds. If the overload condition has been removed, the instrument will resume normal operation.

This overload indicator may flash yellow briefly at start-up. This is not a cause for concern.
3. OUT CONNECTOR. This connector provides the main output signal, into load impedances of 50Ω .
4. SYNC OUT. This connector supplies a SYNC output that can be used to trigger other equipment, particularly oscilloscopes. This signal leads (or lags) the main output by a duration set by the "DELAY" controls and has an approximate amplitude of +3 Volts to $R_L > 1k\Omega$ with a pulse width of approximately 200 ns.
5. LIQUID CRYSTAL DISPLAY (LCD). This LCD is used in conjunction with the keypad to change the instrument settings. Normally, the main menu is displayed, which lists the key adjustable parameters and their current values. The "Programming Manual for -B Instruments" describes the menus and submenus in detail.

6. KEYPAD.

Control Name	Function
MOVE	This moves the arrow pointer on the display.
CHANGE	This is used to enter the submenu, or to select the operating mode, pointed to by the arrow pointer.
×10	If one of the adjustable numeric parameters is displayed, this increases the setting by a factor of ten.
÷10	If one of the adjustable numeric parameters is displayed, this decreases the setting by a factor of ten.
+/-	If one of the adjustable numeric parameters is displayed, and this parameter can be both positive or negative, this changes the sign of the parameter.
EXTRA FINE	This changes the step size of the ADJUST knob. In the extra-fine mode, the step size is twenty times finer than in the normal mode. This button switches between the two step sizes.
ADJUST	This large knob adjusts the value of any displayed numeric adjustable values, such as frequency, pulse width, etc. The adjust step size is set by the "EXTRA FINE" button. When the main menu is displayed, this knob can be used to move the arrow pointer.

REAR PANEL CONTROLS

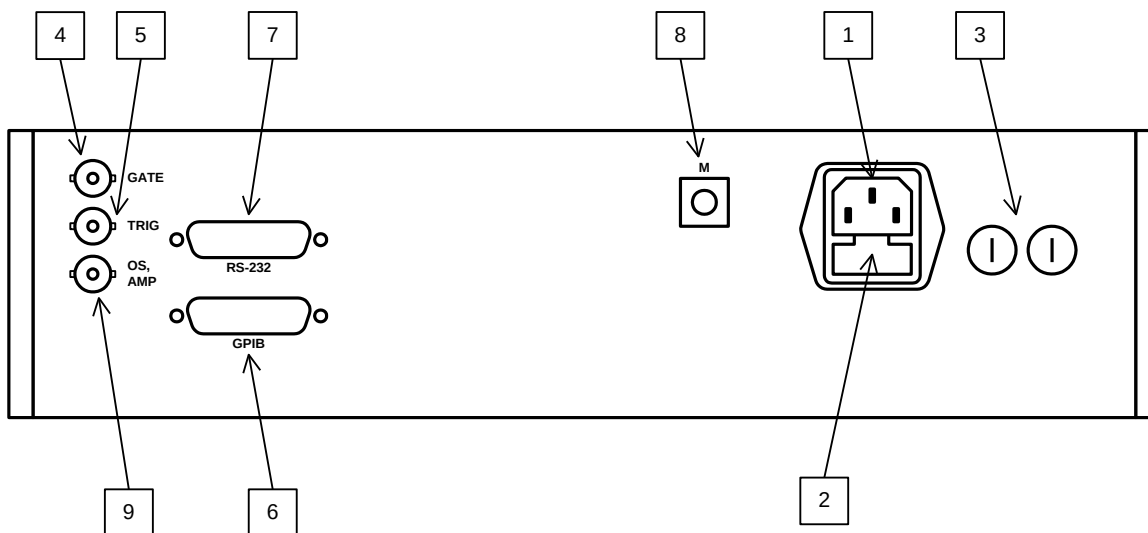

1. AC POWER INPUT. An IEC-320 C14 three-pronged recessed male socket is provided on the back panel for AC power connection to the instrument. One end of the detachable power cord that is supplied with the instrument plugs into this socket.
2. AC FUSE DRAWER. The two fuses that protect the AC input are located in this drawer. Please see the “FUSES” section of this manual for more information.
3. DC FUSES. These two fuses protect the internal DC power supplies. Please see the “FUSES” sections of this manual for more information.
4. GATE. This TTL-level (0 and +5V) logic input can be used to gate the triggering of the instrument. This input can be either active high or active low, depending on the front panel settings or programming commands. (The instrument triggers normally when this input is unconnected). When set to active high mode, this input is pulled-down to ground by a 1 k Ω resistor. When set to active low mode, this input is pulled-up to +5V by a 1 k Ω resistor.
5. TRIG. This TTL-level (0 and +5V) logic input can be used to trigger the instrument, if the instrument is set to triggering externally. The instrument triggers on the rising edge of this input. The input impedance of this input is 1 k Ω . (Depending on the length of cable attached to this input, and the source driving it, it may be desirable to add a coaxial 50 Ohm terminator to this input to provide a proper transmission line termination. The Pasternack (www.pasternack.com) PE6008-50 BNC feed-thru 50 Ohm terminator is suggested for this purpose.)
6. GPIB Connector. A standard GPIB cable can be attached to this connector to allow the instrument to be computer-controlled. See the “Programming Manual for -B Instruments” for more details on GPIB control.

7. RS-232 Connector. A standard serial cable with a 25-pin male connector can be attached to this connector to allow the instrument to be computer-controlled. See the "Programming Manual for -B Instruments" for more details on RS-232 control.
8. M Connector. (Optional feature. Present on "-M" units only.) The monitor output provides an attenuated replica (20 dB down) of the voltage on the main output. The monitor output is designed to operate into a 50 Ohm load.
9. *This connector may implement one of the two following options:*

OS Connector. (Optional feature. Present on "-OS" units only.) The desired DC offset is applied to this connector. Internally, it is connected to the output centre conductor via a high quality RF inductor. Do not exceed $\pm 25V$, 250 mA. When not used, the OS input should be connected to ground.

or

AMP Connector. (Optional feature. Present on "-EA" units only.) The output amplitude can be set to track the voltage on this input. Zero Volts in corresponds to zero amplitude output, and +10V in corresponds to maximum amplitude out. This mode is activated by selecting "Ext Control" on the front-panel amplitude menu, or with the "source:voltage external" command.

GENERAL INFORMATION

BASIC PULSE CONTROL

This instrument can be triggered by its own internal clock or by an external TTL trigger signal. In either case, two output channels respond to the trigger: OUT and SYNC.

- OUT. This is the main output. The maximum output voltage is 50V.
- SYNC. The SYNC pulse is a fixed-width TTL-level reference pulse used to trigger oscilloscopes or other measurement systems. When the delay is set to a positive value the SYNC pulse precedes the OUT pulse. When the delay is set to a negative value the SYNC pulse follows the OUT pulse.

These pulses are illustrated below, assuming internal triggering and a positive delay. All waveforms are shown with positive amplitudes.

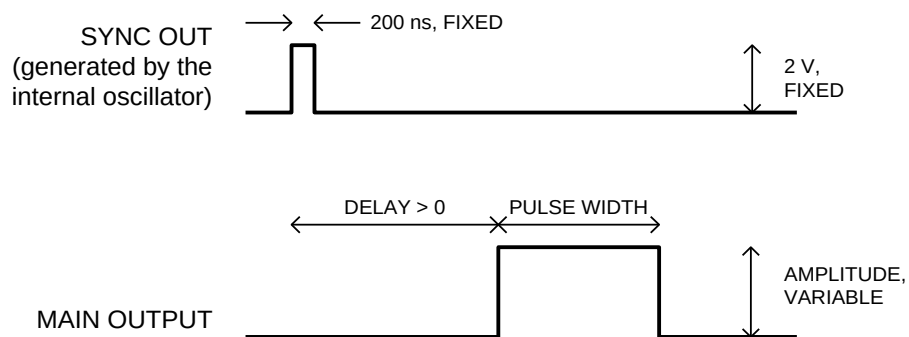

Figure A

If the delay is negative, the order of the SYNC and OUT pulses is reversed:

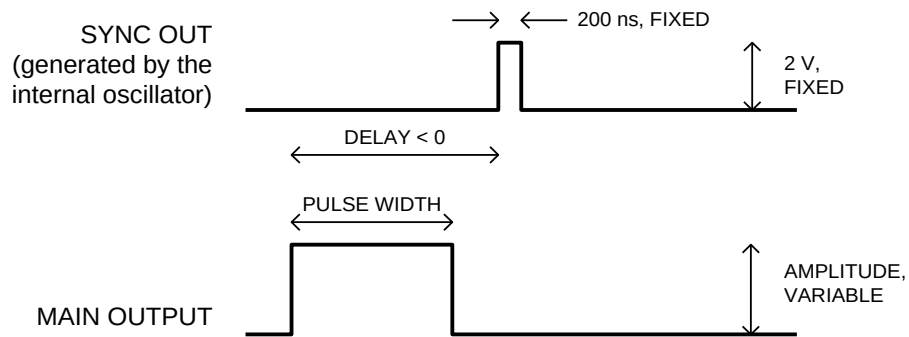

Figure B

The next figure illustrates the relationship between the signal when an external TTL-level trigger is used:

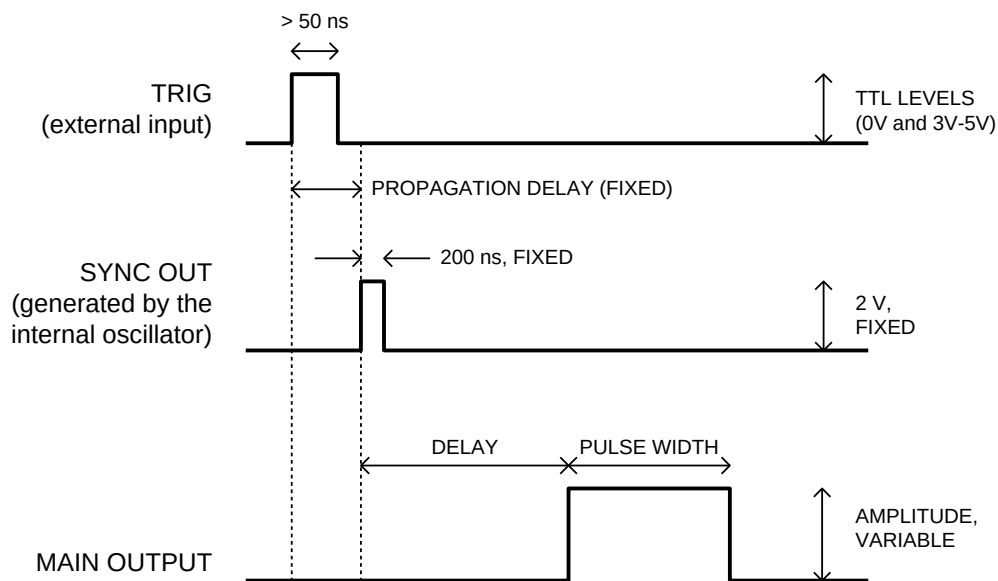

Figure C

As before, if the delay is negative, the order of the SYNC and OUT pulses is reversed.

In general, the delay, pulse width, and frequency (when in the internal mode), of the OUT pulse can be varied with front panel controls or via the GPIB or RS-232 computer interfaces.

TRIGGER MODES

This instrument has four trigger modes:

- Internal Trigger: the instrument controls the trigger frequency, and generates the clock internally.
- External Trigger: the instrument is triggered by an external TTL-level clock on the back-panel TRIG connector.
- Manual Trigger: the instrument is triggered by the front-panel "SINGLE PULSE" pushbutton.
- Hold Trigger: the instrument is set to not trigger at all.

These modes can be selected using the front panel trigger menu, or by using the appropriate programming commands. (See the “Programming Manual for -B Instruments” for more details.)

WARNING: The output stage may be damaged if triggered by an external signal at a pulse repetition frequency greater than 100 kHz.

GATING MODES

Triggering can be suppressed by a TTL-level signal on the rear-panel GATE connector. The instrument can be set to stop triggering when this input high or low, using the front-panel gate menu or the appropriate programming commands. When gated, the output will complete the full pulse width if the output is high, and then stop triggering. Pulses are not truncated.

AMPLITUDE DYNAMIC RANGE

Avtech high-speed pulse generators are optimized to operate near their maximum rated amplitude. Generally, operation below 20% of the maximum rated amplitude is not recommended. To generate pulses below this level, the pulse generator should be operated near its maximum rated amplitude, and one or more coaxial attenuators should be connected to the output.

Avtech suggest the Midwest Microwave ATT-0527-XX-SMA-07 family of fixed 12 GHz, 20 Watt attenuators for use with the AVR-E2-B.

For more information, please see the Avtech application note “How Can I Extend the Amplitude Range to Low Levels?” at <http://www.avtechpulse.com/appnote/techbrief11/>.

OPTIONAL FEATURES

DC OFFSET, "-OS" OPTION

A DC offset can be added to the output signal by applying a DC voltage to the rear-panel OS connector. Internally, it is connected to the output centre conductor via a high quality RF inductor. Do not exceed $\pm 25\text{V}$, 250 mA.

MONITOR OUTPUT, "-M" OPTION

The monitor output provides an attenuated replica (20 dB down) of the voltage on the main output. The monitor output is designed to operate into a 50 Ohm load.

ELECTRONIC AMPLITUDE CONTROL, "-EA" OPTION

The output amplitude can be set to track the voltage on this input. Zero Volts in corresponds to zero amplitude output, and +10V in corresponds to maximum amplitude out. This mode is activated by selecting "Ext Control" on the front-panel amplitude menu, or with the "source:voltage external" command.

PROTECTING YOUR INSTRUMENT

TURN OFF INSTRUMENT WHEN NOT IN USE

The lifetime of the switching elements in the pulse generator module is proportional to the running time of the instrument. For this reason the prime power to the instrument should be turned off when the instrument is not in use. In the case of failure, the switching elements are easily replaced following the procedure described in a following section.

DO NOT EXCEED 100 kHz

The output stage may be damaged if triggered by an external signal at a pulse repetition frequency greater than 100 kHz.

USE A 50 OHM LOAD

The output stage may be damaged if the output is not terminated into a 50 Ω load.

OPERATIONAL CHECK

This section describes a sequence to confirm the basic operation of the instrument. It should be performed after receiving the instrument. It is a useful learning exercise as well.

Before proceeding with this procedure, finish reading this instruction manual thoroughly. Then read the “Local Control” section of the “Programming Manual for -B Instruments” thoroughly. The “Local Control” section describes the front panel controls used in this operational check - in particular, the MOVE, CHANGE, and ADJUST controls.

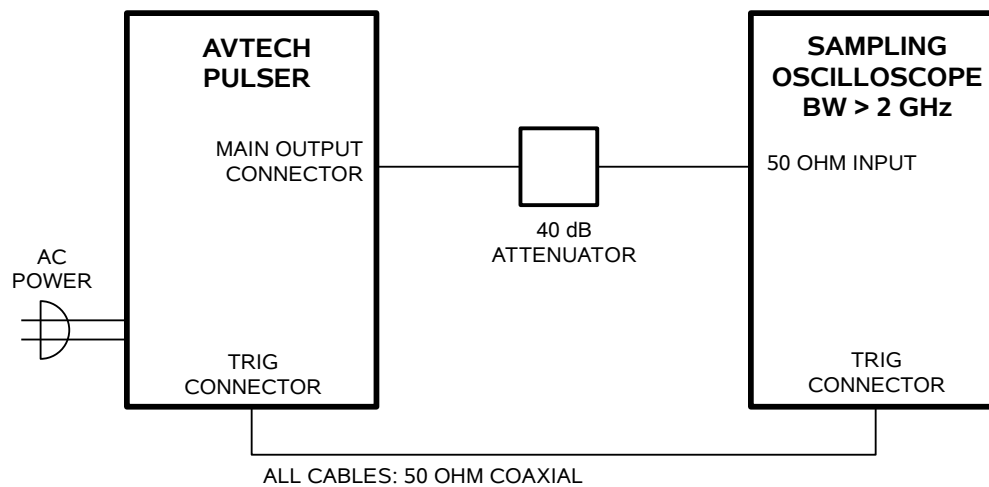

BASIC TEST ARRANGEMENT

1. Connect the pulse generator to a sampling oscilloscope as shown above. Note that:
 - a) The use of 40 dB attenuator at the sampling scope vertical input channel will ensure a peak input signal to the sampling scope of less than 1 Volt. Factory tests are conducted using Midwest Microwave model ATT-0527-20-SMA-07 attenuators.
 - b) The TRIG output channel provides TTL level signals (approximately 0 and +3V). To avoid overdriving the TRIG input channel of some scopes, a 20 dB attenuator should be placed at the input to the scope trigger channel.
 - c) The bandwidth capability of components and instruments used to display the pulse generator output signal (attenuators, cables, connectors, etc.) should exceed 2 GHz.

- d) Set the oscilloscope to trigger externally with the vertical setting at 100 mV/div and the horizontal setting at 20 ns/div.
2. Turn on the AVR-E2-B. The main menu will appear on the LCD.
 3. To set the AVR-E2-B to trigger from the internal clock at a PRF of 2 kHz:
 - a) The arrow pointer should be pointing at the frequency menu item. If it is not, press the MOVE button until it is.
 - b) Press the CHANGE button. The frequency submenu will appear. Rotate the ADJUST knob until the frequency is set at 2 kHz.
 - c) The arrow pointer should be pointing at the “Internal” choice. If it is not, press MOVE until it is.
 - d) Press CHANGE to return to the main menu.
 4. To set the delay to 100 ns:
 - a) Press the MOVE button until the arrow pointer is pointing at the delay menu item.
 - b) Press the CHANGE button. The delay submenu will appear. Rotate the ADJUST knob until the delay is set at 100 ns.
 - c) The arrow pointer should be pointing at the “Normal” choice. If it is not, press MOVE until it is.
 - d) Press CHANGE to return to the main menu.
 5. To set the pulse width to 50 ns:
 - a) Press the MOVE button until the arrow pointer is pointing at the pulse width menu item.
 - b) Press the CHANGE button. The pulse width submenu will appear. Rotate the ADJUST knob until the pulse width is set at 50 ns.
 - c) The arrow pointer should be pointing at the “Normal” choice. If it is not, press MOVE until it is.
 - d) Press CHANGE to return to the main menu.
 6. At this point, nothing should appear on the oscilloscope.
 7. To enable the output:

- a) Press the MOVE button until the arrow pointer is pointing at the output menu item.
 - b) Press the CHANGE button. The output submenu will appear.
 - c) Press MOVE until the arrow pointer is pointing at the "ON" choice.
 - d) Press CHANGE to return to the main menu.
8. To change the output amplitude:
- a) Press the MOVE button until the arrow pointer is pointing at the amplitude menu item.
 - b) Press the CHANGE button. The amplitude submenu will appear. Rotate the ADJUST knob until the amplitude is set at +50V (or -50V for "-N" models).
 - c) Observe the oscilloscope. You should see 50 ns wide, 50V pulses. If you do not, you may need to adjust the delay setting to a value more compatible with your sampling oscilloscope. Repeat step 4 if required. You may also need to adjust the sampling scope controls.
 - d) Rotate the ADJUST knob. The amplitude as seen on the oscilloscope should vary. Return it to 50V.
 - e) ("-PN" units only) Press the +/- button on the front panel. The amplitude as seen on the oscilloscope should flip polarity, to -50V.
 - f) Press CHANGE to return to the main menu.
9. Try varying the pulse width, by repeating step (5). As you rotate the ADJUST knob, the pulse width on the oscilloscope will change. It should agree with the displayed value.

This completes the operational check.

MECHANICAL INFORMATION

TOP COVER REMOVAL

If necessary, the interior of the instrument may be accessed by removing the four Phillips screws on the top panel. With the four screws removed, the top cover may be slid back (and off).

Always disconnect the power cord before opening the instrument.

There are no user-adjustable internal circuits. For repairs other than fuse replacement, please contact Avtech (info@avtechpulse.com) to arrange for the instrument to be returned to the factory for repair.

⚠ Caution: High voltages are present inside the instrument during normal operation. Do not operate the instrument with the cover removed.

RACK MOUNTING

A rack mounting kit is available. The -R5 rack mount kit may be installed after first removing the one Phillips screw on the side panel adjacent to the front handle.

ELECTROMAGNETIC INTERFERENCE

To prevent electromagnetic interference with other equipment, all used outputs should be connected to shielded 50Ω loads using shielded 50Ω coaxial cables. Unused outputs should be terminated with shielded 50Ω coaxial terminators or with shielded coaxial dust caps, to prevent unintentional electromagnetic radiation. All cords and cables should be less than 3m in length.

MAINTENANCE

REGULAR MAINTENANCE

This instrument does not require any regular maintenance.

On occasion, one or more of the four rear-panel fuses may require replacement. All fuses can be accessed from the rear panel. See the “FUSES” section for details.

CLEANING

If desired, the interior of the instrument may be cleaned using compressed air to dislodge any accumulated dust. (See the “TOP COVER REMOVAL” section for instructions on accessing the interior.) No other cleaning is recommended.

PROGRAMMING YOUR PULSE GENERATOR

KEY PROGRAMMING COMMANDS

The “Programming Manual for -B Instruments” describes in detail how to connect the pulse generator to your computer, and the programming commands themselves. A large number of commands are available; however, normally you will only need a few of these. Here is a basic sample sequence of commands that might be sent to the instrument after power-up:

*rst	(resets the instrument)
trigger:source internal	(selects internal triggering)
frequency 1000 Hz	(sets the frequency to 1000 Hz)
pulse:width 50 ns	(sets the pulse width to 50 ns)
pulse:delay 20 ns	(sets the delay to 20 ns)
volt:ampl 45	(sets the amplitude to +45 V)
	("-N" units should use "volt:ampl -45)
output on	(turns on the output)

For triggering a single event, this sequence would be more appropriate:

*rst	(resets the instrument)
trigger:source hold	(turns off all triggering)
pulse:width 50 ns	(sets the pulse width to 50 ns)
output on	(turns on the output)
volt:ampl 45	(sets the amplitude to +45 V)
	("-N" units should use "volt:ampl -45)
trigger:source immediate	(generates a single non-repetitive trigger event)
trigger:source hold	(turns off all triggering)
output off	(turns off the output)

To set the instrument to trigger from an external TTL signal applied to the rear-panel TRIG connector, use:

*rst	(resets the instrument)
trigger:source external	(selects external triggering)
pulse:width 50 ns	(sets the pulse width to 50 ns)
pulse:delay 1 us	(sets the delay to 1 us)
volt:ampl 45	(sets the amplitude to +45 V)
	("-N" units should use "volt:ampl -45)
output on	(turns on the output)

These commands will satisfy 90% of your programming needs.

ALL PROGRAMMING COMMANDS

For more advanced programmers, a complete list of the available commands is given below. These commands are described in detail in the “Programming Manual for -B Instruments”. (Note: this manual also includes some commands that are not implemented in this instrument. They can be ignored.)

<u>Keyword</u>	<u>Parameter</u>	<u>Notes</u>
LOCAL		
OUTPut:		
:[STATe]	<boolean value>	
:PROTection		
:TRIPped?		[query only]
REMOTE		
[SOURce]:		
:FREQuency		
[:CW FIXed]	<numeric value>	
[SOURce]:		
:PULSe		
:PERiod	<numeric value>	
:WIDTh	<numeric value>	
:DCYClE	<numeric value>	
:HOLD	WIDTh DCYClE	
:DELay	<numeric value>	
:GATE		
:TYPE	ASYNc SYNc	
:LEVel	HIgh LOw	
[SOURce]:		
:VOLTage		
[:LEVel]		
[:IMMEdiate]		
[:AMPLitude]	<numeric value> EXTernal	
:PROTection		
:TRIPped?		[query only]
STATUS:		
:OPERation		
:[EVENT]?		[query only, always returns "0"]
:CONDition?		[query only, always returns "0"]
:ENABle	<numeric value>	[implemented but not useful]
:QUEStionable		
:[EVENT]?		[query only, always returns "0"]
:CONDition?		[query only, always returns "0"]
:ENABle	<numeric value>	[implemented but not useful]
SYSTEM:		
:COMMunicate		
:GPIB		
:ADDReSS	<numeric value>	
:SERial		
:CONTRol		
:RTS	ON IBFull RFR	
:[RECeive]		
:BAUD	1200 2400 4800 9600	
:BITS	7 8	
:ECHO	<boolean value>	
:PARity		

	: [TYPE]	EVEN ODD NONE	
	: SBITS	1 2	
:ERRor			
:[NEXT]?			[query only]
:COUNT?			[query only]
:VERSion?			[query only]
TRIGger:			
:SOURce		INTernal EXTernal MANual HOLD IMMEDIATE	
*CLS			[no query form]
*ESE		<numeric value>	
*ESR?			[query only]
*IDN?			[query only]
*OPC			
*SAV		0 1 2 3	[no query form]
*RCL		0 1 2 3	[no query form]
*RST			[no query form]
*SRE		<numeric value>	
*STB?			[query only]
*TST?			[query only]
*WAI			[no query form]

PERFORMANCE CHECKSHEET