



AVTECH ELECTROSYSTEMS LTD.

NANOSECOND WAVEFORM ELECTRONICS
SINCE 1975

P.O. BOX 265
OGDENSBURG, NY
U.S.A. 13669-0265

TEL: 888-670-8729 (USA & Canada) or +1-613-686-6675 (Intl)
FAX: 800-561-1970 (USA & Canada) or +1-613-686-6679 (Intl)

info@avtechpulse.com - <http://www.avtechpulse.com/>

BOX 5120, LCD MERIVALE
OTTAWA, ONTARIO
CANADA K2C 3H4

INSTRUCTIONS

MODEL AVR-EB2A-B

± 100 mA "CONDITION A"

REVERSE RECOVERY

MEASUREMENT SYSTEM

SERIAL NUMBER: _____

WARRANTY

Avtech Electrosystems Ltd. warrants products of its manufacture to be free from defects in material and workmanship under conditions of normal use. If, within one year after delivery to the original owner, and after prepaid return by the original owner, this Avtech product is found to be defective, Avtech shall at its option repair or replace said defective item. This warranty does not apply to units which have been disassembled, modified or subjected to conditions exceeding the applicable specifications or ratings. This warranty is the extent of the obligation assumed by Avtech with respect to this product and no other warranty or guarantee is either expressed or implied.

TECHNICAL SUPPORT

Phone: 888-670-8729 (USA & Canada) or +1-613-686-6675 (International)

Fax: 800-561-1970 (USA & Canada) or +1-613-686-6679 (International)

E-mail: info@avtechpulse.com

World Wide Web: <http://www.avtechpulse.com>

TABLE OF CONTENTS

WARRANTY.....	2
TECHNICAL SUPPORT.....	2
TABLE OF CONTENTS.....	3
INTRODUCTION.....	6
SPECIFICATIONS.....	8
REGULATORY NOTES.....	9
FCC PART 18.....	9
EC DECLARATION OF CONFORMITY.....	9
DIRECTIVE 2002/95/EC (RoHS).....	10
DIRECTIVE 2002/96/EC (WEEE).....	10
AC POWER SUPPLY REGULATORY NOTES.....	11
INSTALLATION.....	12
VISUAL CHECK.....	12
POWER RATINGS.....	12
CONNECTION TO THE POWER SUPPLY.....	12
PROTECTION FROM ELECTRIC SHOCK.....	13
ENVIRONMENTAL CONDITIONS.....	14
FUSES.....	15
AC FUSE REPLACEMENT.....	15
DC FUSE REPLACEMENT.....	16
FUSE RATINGS.....	16
FRONT PANEL CONTROLS.....	17
REAR PANEL CONTROLS.....	19
TIMING CONTROL.....	21
MAINFRAME PULSE OUTPUT.....	21
TRIGGER MODES.....	22
GATING MODES.....	24
BASIC AMPLITUDE CONTROL.....	25
SETTING THE AMPLITUDE LEVELS.....	26
AMPLITUDE ACCURACY.....	26
CURRENT MONITOR.....	26
INCORRECT ORIENTATION.....	27

STANDARD TEST JIG MECHANICAL ASPECTS.....	28
AVX-CA-AR1 TEST JIG.....	28
REPLACEMENT SOCKETS.....	32
CUSTOMIZED TEST JIGS.....	33
AVX-CA-KMPB-TO39.....	33
TYPICAL RESULTS.....	34
1N4148 RESULTS.....	34
MQ1N5811US RESULTS.....	36
1N5819 RESULTS.....	38
WITH NO DUT.....	40
TROUBLESHOOTING.....	42
PROGRAMMING YOUR PULSE GENERATOR.....	43
KEY PROGRAMMING COMMANDS.....	43
ALL PROGRAMMING COMMANDS.....	44
MECHANICAL INFORMATION.....	46
TOP COVER REMOVAL.....	46
RACK MOUNTING.....	46
ELECTROMAGNETIC INTERFERENCE.....	46
MAINTENANCE.....	47
REGULAR MAINTENANCE.....	47
CLEANING.....	47
WIRING DIAGRAMS.....	48
WIRING OF AC POWER.....	48
PCB 158N - LOW VOLTAGE POWER SUPPLY, 1/3.....	49
PCB 158N - LOW VOLTAGE POWER SUPPLY, 2/3.....	50
PCB 158N - LOW VOLTAGE POWER SUPPLY, 3/3.....	51
PCB 168B - HIGH VOLTAGE DC POWER SUPPLY.....	52
PCB 210A - INTERLOCK.....	53
PCB 116C - CURRENT MONITOR.....	54
PCB 104D - KEYPAD / DISPLAY BOARD, 1/3.....	55
PCB 104D - KEYPAD / DISPLAY BOARD, 2/3.....	56
PCB 104D - KEYPAD / DISPLAY BOARD, 3/3.....	57
MAIN WIRING.....	58
STANDARD TEST JIG WIRING (AVX-CA-AR1).....	59
CUSTOMIZED TEST JIG WIRING (AVX-CA-KMBP-TO39).....	60

PERFORMANCE CHECK SHEET.....61

Manual Reference: /files/officefiles/instructword/avr-eb/avr-eb2a-b/AVR-EB2A-B,ed4.odt.
Last modified February 29, 2024.
Copyright © 2024 Avtech Electrosystems Ltd, All Rights Reserved.

INTRODUCTION

The AVR-EB2A-B is a high performance, GPIB and RS232-equipped pulse generator used for measuring the reverse recovery time of high-speed, low-current signal diodes.

The AVR-EB2A-B generates a forward DC bias current of +10 to +100 mA. A 200 ns wide negative pulse is superimposed onto the signal, to generate reverse currents of up to -100 mA.

The 10%-90% switching time for the positive to negative transition is much less than 500 ps (typically 200 ps), measured at the input to the test jig. The jig and the inductance and switching dynamic of the device under test (DUT) degrade this to approximately 700 ps typically, measured at the output of the jig.

The waveforms generated by this instrument are generally suitable for MIL-STD-750E Method 4031.4 Test Condition A tests. The basic test arrangement is shown below:

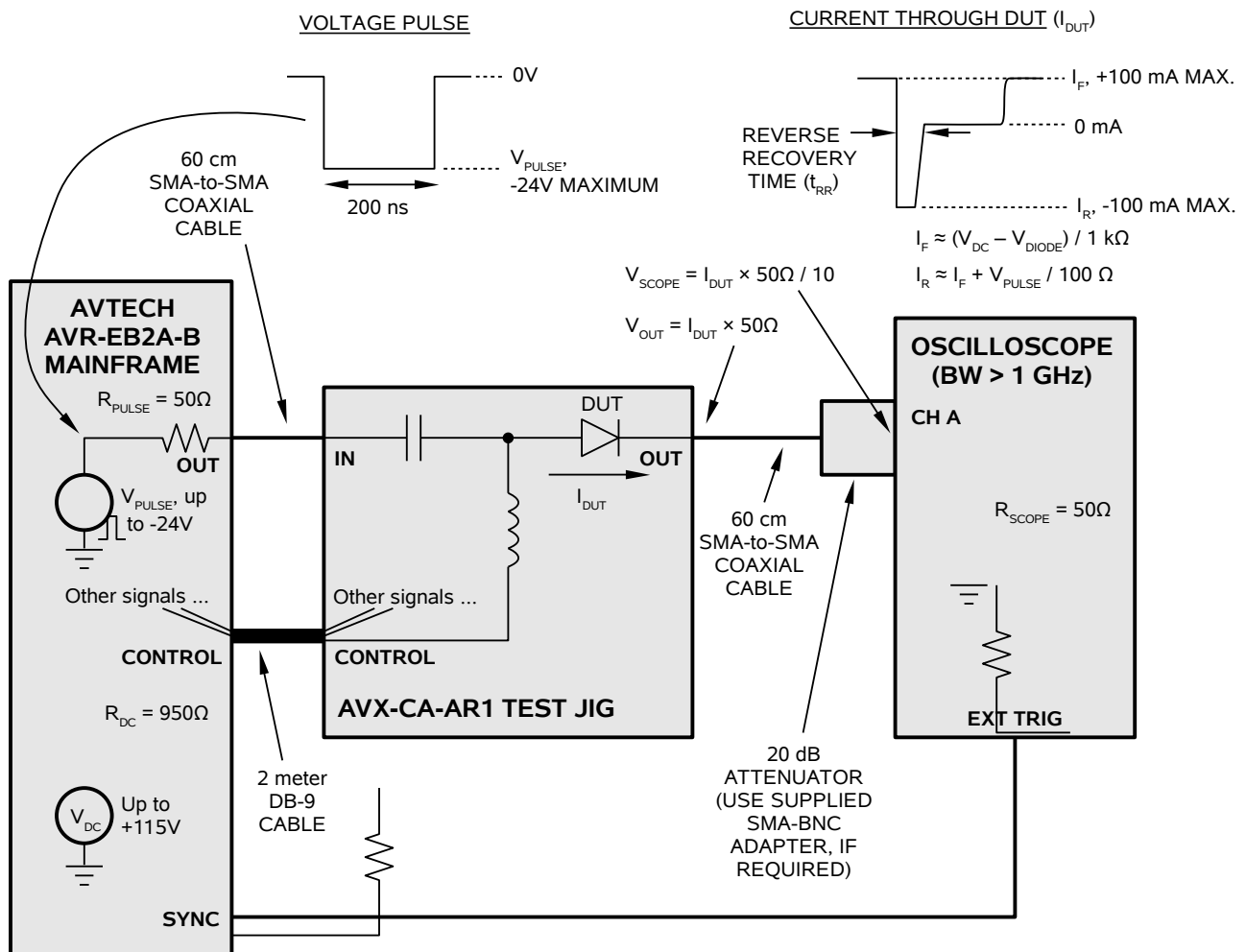

Standard AVR-EB2A-B models include one AVX-CA-AR1 diode test jig. The instrument mainframe is connected to the test jig using one coaxial cable and one DB-9 control cable. The test jig has a hinged lid, which must be fully closed to protect the user from high voltages. The output will be automatically disabled if the lid is left open.

The standard AVX-CA-AR1 test jig has been designed to accept a variety of axial and SQMELF packages. It has been designed specifically to accept:

1. Microsemi "Type E" axial packages (used in the 1N5418 and other devices)
2. Generic DO-41 packages (used in the 1N5819 and other devices)
3. Microsemi Type A square MELF, also called D-5A (for example, 1N5806US)
4. Microsemi Type B square MELF, also called D-5D (for example, 1N6701US)
5. Microsemi Type E square MELF, also called D-5B (for example, 1N5811US)

The AVR-EB2A-B may also be provided with different or additional a customized test jigs, to meet particular customer package requirements.

The output from the test jig must be connected (using the supplied cable and 20 dB attenuator) to the 50 Ohm input of a high-bandwidth (> 1 GHz) user-supplied oscilloscope. The voltage on the output is proportional to the current through the DUT. By observing the current waveform through the DUT, the reverse recovery time may be determined.

The AVR-EB2A-B includes an internal trigger source, but it can also be triggered or gated by an external source. A front-panel pushbutton can also be used to trigger the instrument.

The AVR-EB2A-B features front panel keyboard and adjust knob control of the output pulse parameters along with a four line by 40-character backlit LCD display of the output amplitude, pulse repetition frequency, and delay. The instrument includes memory to store up to four complete instrument setups. The operator may use the front panel or the computer interface to store a complete "snapshot" of all key instrument settings, and recall this setup at a later time.

This instrument is intended for use in research, development, test and calibration laboratories by qualified personnel.

SPECIFICATIONS

Model ¹ :	AVR-EB2A-B	
Recovery type:	Reverse recovery	
Intended application:	High-speed small-signal diodes	
Basic waveform:	Positive DC interrupted by a negative pulse	
Signal portion:	DC	-
Voltage output ² :	+1V to +100V	-1V to -24V
Corresponding diode current ^{2,6} (approx., depends on V _{DIODE}):	< +10 mA to > +100 mA	< -10 mA to > -100 mA
Pulse width (FWHM):	N/A	200 ns
Transition time (10%-90%):	< 300 ps (without test jig), and typically 700 ps with jig and DUT installed.	
Maximum PRF:	10 kHz	
Delay:	0 to ± 1.0 s, variable	
Supplied test jig: (standard models)	<p>Model AVX-CA-AR1. It has been designed specifically to accept:</p> <ol style="list-style-type: none"> 1. Microsemi "Type E" axial packages (used in the 1N5418 and other devices) 2. Generic DO-41 packages (used in the 1N5819 and other devices) 3. Microsemi Type A square MELF, also called D-5A (for example, 1N5806US) 4. Microsemi Type B square MELF, also called D-5D (for example, 1N6701US) 5. Microsemi Type E square MELF, also called D-5B (for example, 1N5811US) 	
GPIB and RS-232 control:	Standard on -B units. See http://www.avtechpulse.com/gpib for details.	
Trigger required:	Ext trig mode: + 5 Volts, 10 ns or wider (TTL)	
Gate input	Active high or low, switchable. Suppresses triggering when active.	
Power requirements:	100 - 240 Volts, 50 - 60 Hz	
Dimensions:	H x W x D: 100 mm x 430 mm x 375 mm (3.9" x 17" x 14.8")	
Chassis material:	cast aluminum frame and handles, blue vinyl on aluminum cover plates	
Temperature range:	+5°C to +40°C	

1) -B suffix indicates IEEE-488.2 GPIB and RS-232 control of amplitude, pulse width, PRF and delay (see <http://www.avtechpulse.com/gpib>).

2) The amplitude settings should not be relied upon for any degree of accuracy, because the dynamics of the device under test can affect the actual generated waveforms. Amplitude settings should always be verified by oscilloscope measurements.

REGULATORY NOTES

FCC PART 18

This device complies with part 18 of the FCC rules for non-consumer industrial, scientific and medical (ISM) equipment.

This instrument is enclosed in a rugged metal chassis and uses a filtered power entry module (where applicable). The main output signal is provided on a shielded connector that is intended to be used with shielded coaxial cabling and a shielded load. Under these conditions, the interference potential of this instrument is low.

If interference is observed, check that appropriate well-shielded cabling is used on the output connectors. Contact Avtech (info@avtechpulse.com) for advice if you are unsure of the most appropriate cabling. Also, check that your load is adequately shielded. It may be necessary to enclose the load in a metal enclosure.

If any of the connectors on the instrument are unused, they should be covered with shielded metal "dust caps" to reduce the interference potential.

This instrument does not normally require regular maintenance to minimize interference potential. However, if loose hardware or connectors are noted, they should be tightened. Contact Avtech (info@avtechpulse.com) if you require assistance.

EC DECLARATION OF CONFORMITY



We Avtech Electrosystems Ltd.
 P.O. Box 5120, LCD Merivale
 Ottawa, Ontario
 Canada K2C 3H4

declare that this pulse generator meets the intent of Directive 2004/108/EG for Electromagnetic Compatibility. Compliance pertains to the following specifications as listed in the official Journal of the European Communities:

EN 50081-1 Emission

EN 50082-1 Immunity

and that this pulse generator meets the intent of the Low Voltage Directive 72/23/EEC as amended by 93/68/EEC. Compliance pertains to the following specifications as listed in the official Journal of the European Communities:

EN 61010-1:2001 Safety requirements for electrical equipment for measurement, control, and laboratory use

DIRECTIVE 2002/95/EC (RoHS)

This instrument is exempt from Directive 2002/95/EC of the European Parliament and of the Council of 27 January 2003 on the Restriction of the use of certain Hazardous Substances (RoHS) in electrical and electronic equipment. Specifically, Avtech instruments are considered "Monitoring and control instruments" (Category 9) as defined in Annex 1A of Directive 2002/96/EC. The Directive 2002/95/EC only applies to Directive 2002/96/EC categories 1-7 and 10, as stated in the "Article 2 - Scope" section of Directive 2002/95/EC.

DIRECTIVE 2002/96/EC (WEEE)

European customers who have purchased this equipment directly from Avtech will have completed a "WEEE Responsibility Agreement" form, accepting responsibility for WEEE compliance (as mandated in Directive 2002/96/EC of the European Union and local laws) on behalf of the customer, as provided for under Article 9 of Directive 2002/96/EC.

Customers who have purchased Avtech equipment through local representatives should consult with the representative to determine who has responsibility for WEEE compliance. Normally, such responsibilities will lie with the representative, unless other arrangements (under Article 9) have been made.

Requirements for WEEE compliance may include registration of products with local governments, reporting of recycling activities to local governments, and financing of recycling activities.

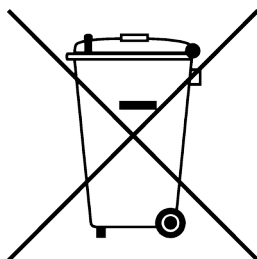

AC POWER SUPPLY REGULATORY NOTES

This instrument converts the AC input power to the +24V DC voltage that powers the internal circuitry of this instrument using a Tamura AAD130SD-60-A switching power supply. According to the manufacturer, the Tamura AAD130SD-60-A has the following certifications:

UL60950-1
IEC60950 -1
CSA C22.2 No. 60950- 1
EN60950 -1

and is compliant with:

EN61000-3-2
EN61000-4-2 Level 2
EN61000-4-2 Level 3 (Air Only)
EN61000-4-4 Level 3
EN61000-4-5 Level 3
EN61000-4-11
CISPR 11 and 22 FCC Part 15 Class B (conducted)

INSTALLATION

VISUAL CHECK

After unpacking the instrument, examine to ensure that it has not been damaged in shipment. Visually inspect all connectors, knobs, liquid crystal displays (LCDs), and the handles. If the instrument has been damaged, file a claim immediately with the company that transported the instrument.

The following items should be with the instrument:

1. One power cord.
2. One GPIB cable
3. Two instrumentation manuals (this manual and the “Programming Manual for -B Instruments”).
4. One test jig, with a hinged lid.
5. One 2m DB9 control cable.
6. Two 60cm SMA-to-SMA coaxial cables.
7. One 20 dB / 2 W attenuator.
8. One BNC(M)/SMA(F) adapter.

Customized units may included additional or modified test jigs.

POWER RATINGS

This instrument is intended to operate from 100 - 240 V, 50 - 60 Hz.

The maximum power consumption is 74 Watts. Please see the “FUSES” section for information about the appropriate AC and DC fuses.

This instrument is an “Installation Category II” instrument, intended for operation from a normal single-phase supply.

CONNECTION TO THE POWER SUPPLY

An IEC-320 three-pronged recessed male socket is provided on the back panel for AC power connection to the instrument. One end of the detachable power cord that is supplied with the instrument plugs into this socket. The other end of the detachable power cord plugs into the local mains supply. Use only the cable supplied with the instrument. The mains supply must be earthed, and the cord used to connect the instrument to the mains supply must provide an earth connection. (The supplied cord does this.)

 Warning: Failure to use a grounded outlet may result in injury or death due to electric shock. This product uses a power cord with a ground connection. It must be

connected to a properly grounded outlet. The instrument chassis is connected to the ground wire in the power cord.

The table below describes the power cord that is normally supplied with this instrument, depending on the destination region:

Destination Region	Description	Option	Manufacturer	Part Number
United Kingdom, Hong Kong, Singapore, Malaysia	BS 1363, 230V, 50 Hz	-AC00	Qualtek	370001-E01
Australia, New Zealand	AS 3112:2000, 230-240V, 50 Hz	-AC01	Qualtek	374003-A01
Continental Europe, Korea, Indonesia, Russia	European CEE 7/7 "Schuko" 230V, 50 Hz	-AC02	Qualtek	364002-D01
North America, Taiwan	NEMA 5-15, 120V, 60 Hz	-AC03	Qualtek	312007-01
Switzerland	SEV 1011, 230V, 50 Hz	-AC06	Qualtek	378001-E01
South Africa, India	SABS 164-1, 220-250V, 50 Hz	-AC17	Volex	2131H 10 C3
Japan	JIS 8303, 100V, 50-60 Hz	-AC18	Qualtek	397002-01
Israel	SI 32, 220V, 50 Hz	-AC19	Qualtek	398001-01
China	GB 1002-1, 220V, 50 Hz	-AC22	Volex	2137H 10 C3

PROTECTION FROM ELECTRIC SHOCK

 Operators of this instrument must be protected from electric shock at all times. The owner must ensure that operators are prevented access and/or are insulated from every connection point. In some cases, connections must be exposed to potential human contact. Operators must be trained to protect themselves from the risk of electric shock. This instrument is intended for use by qualified personnel who recognize shock hazards and are familiar with safety precautions required to avoid possibly injury. In particular, operators should:

1. Keep exposed high-voltage wiring to an absolute minimum.
2. Wherever possible, use shielded connectors and cabling.
3. Connect and disconnect loads and cables only when the instrument is turned off.

4. Keep in mind that all cables, connectors, oscilloscope probes, and loads must have an appropriate voltage rating.
5. Do not attempt any repairs on the instrument, beyond the fuse replacement procedures described in this manual. Contact Avtech technical support (see page 2 for contact information) if the instrument requires servicing. Service is to be performed solely by qualified service personnel.

ENVIRONMENTAL CONDITIONS

This instrument is intended for use under the following conditions:

1. indoor use;
2. altitude up to 2 000 m;
3. temperature 5 °C to 40 °C;
4. maximum relative humidity 80 % for temperatures up to 31 °C decreasing linearly to 50 % relative humidity at 40 °C;
5. Mains supply voltage fluctuations up to ± 10 % of the nominal voltage;
6. no pollution or only dry, non-conductive pollution.

FUSES

This instrument contains four fuses. All are accessible from the rear-panel. Two protect the AC prime power input, and two protect the internal DC power supplies. The locations of the fuses on the rear panel are shown in the figure below:

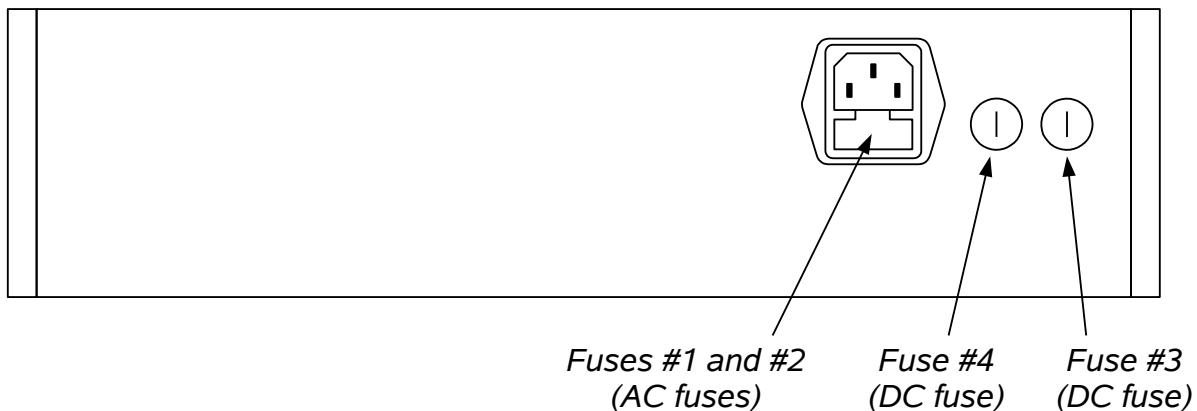

AC FUSE REPLACEMENT

To physically access the AC fuses, the power cord must be detached from the rear panel of the instrument. The fuse drawer may then be extracted using a small flat-head screwdriver, as shown below:

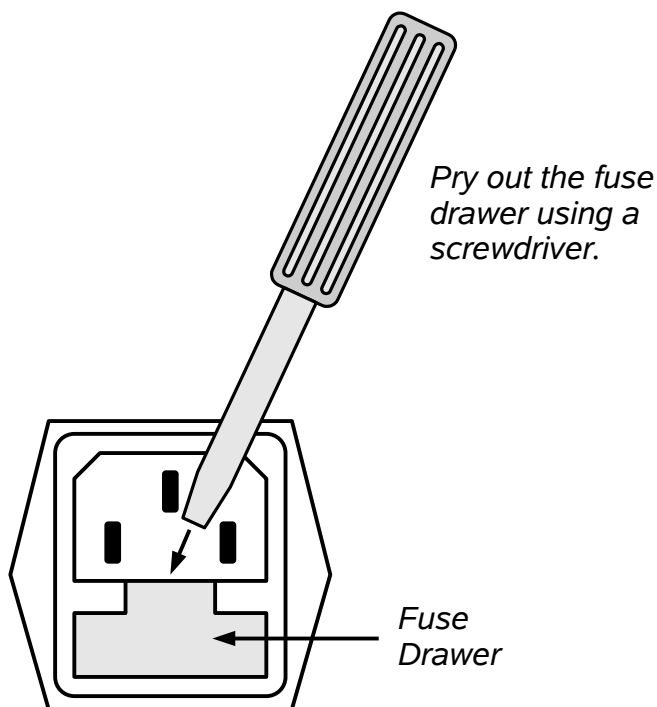

DC FUSE REPLACEMENT

The DC fuses may be replaced by inserting the tip of a flat-head screwdriver into the fuse holder slot, and rotating the slot counter-clockwise. The fuse and its carrier will then pop out.

FUSE RATINGS

The following table lists the required fuses:

Fuses	Nominal Mains Voltage	Rating	Case Size	Recommended Replacement Part	
				Littelfuse Part Number	Digi-Key Stock Number
#1, #2 (AC)	100-240V	0.5A, 250V, Time-Delay	5×20 mm	0218.500HXP	F2416-ND
#3 (DC)	N/A	2.0A, 250V, Time-Delay	5×20 mm	0218002.HXP	F2420-ND
#4 (DC)	N/A	1.0A, 250V, Time-Delay	5×20 mm	0218001.HXP	F2419-ND

The recommended fuse manufacturer is Littelfuse (<http://www.littelfuse.com>).

Replacement fuses may be easily obtained from Digi-Key (<http://www.digikey.com>) and other distributors.

FRONT PANEL CONTROLS

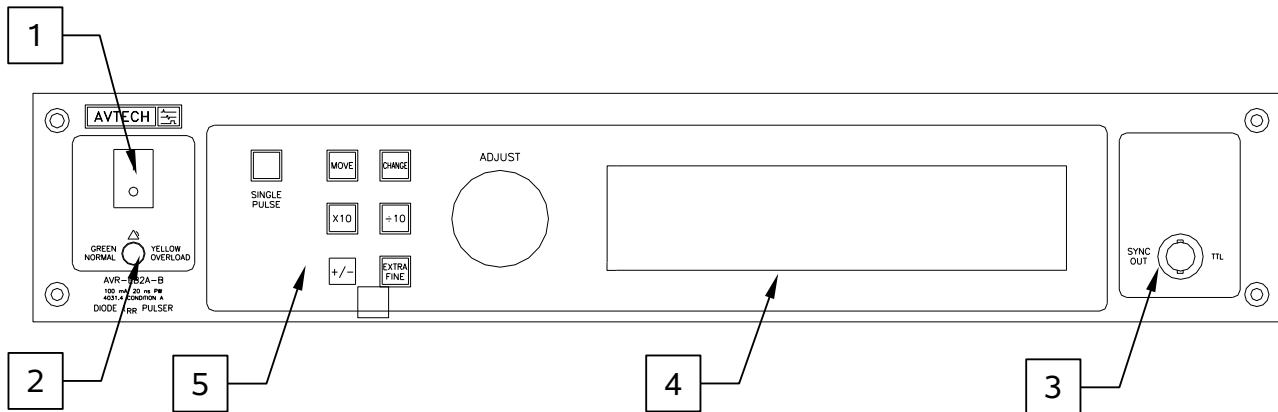

1. POWER Switch. This is the main power switch. When turning the instrument on, there may be a delay of several seconds before the instrument appears to respond.
2. OVERLOAD Indicator. When the instrument is powered, this indicator is normally green, indicating normal operation. If this indicator is yellow, an internal automatic overload protection circuit has been tripped. If the unit is overloaded (by operating at an exceedingly high duty cycle or by operating into a very low impedance), the protective circuit will disable the output of the instrument and turn the indicator light yellow. The light will stay yellow (i.e. output disabled) for about 5 seconds after which the instrument will attempt to re-enable the output (i.e. light green) for about 1 second. If the overload condition persists, the output will be disabled again (i.e. light yellow) for another 5 seconds. If the overload condition has been removed, the instrument will resume normal operation.

This overload indicator may flash yellow briefly at start-up. This is not a cause for concern.
3. SYNC OUT. This connector supplies a SYNC output that can be used to trigger other equipment, particularly oscilloscopes. This signal leads (or lags) the main output by a duration set by the "DELAY" controls and has an approximate amplitude of +3 Volts to $R_L > 50\Omega$ with a pulse width of approximately 100 ns.
4. LIQUID CRYSTAL DISPLAY (LCD). This LCD is used in conjunction with the keypad to change the instrument settings. Normally, the main menu is displayed, which lists the key adjustable parameters and their current values. The "Programming Manual for -B Instruments" describes the menus and submenus in detail.

5. KEYPAD.

Control Name	Function
MOVE	This moves the arrow pointer on the display.
CHANGE	This is used to enter the submenu, or to select the operating mode, pointed to by the arrow pointer.
×10	If one of the adjustable numeric parameters is displayed, this increases the setting by a factor of ten.
÷10	If one of the adjustable numeric parameters is displayed, this decreases the setting by a factor of ten.
+/-	If one of the adjustable numeric parameters is displayed, and this parameter can be both positive or negative, this changes the sign of the parameter.
EXTRA FINE	This changes the step size of the ADJUST knob. In the extra-fine mode, the step size is twenty times finer than in the normal mode. This button switches between the two step sizes.
ADJUST	This large knob adjusts the value of any displayed numeric adjustable values, such as frequency, pulse width, etc. The adjust step size is set by the "EXTRA FINE" button. When the main menu is displayed, this knob can be used to move the arrow pointer.

REAR PANEL CONTROLS

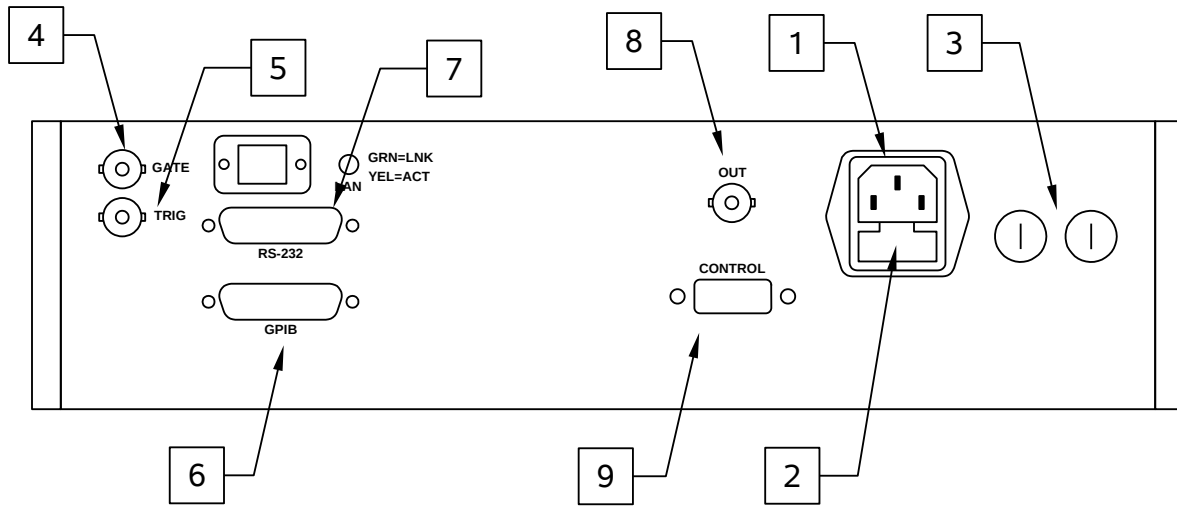

1. AC POWER INPUT. An IEC-320 C14 three-pronged recessed male socket is provided on the back panel for AC power connection to the instrument. One end of the detachable power cord that is supplied with the instrument plugs into this socket.
2. AC FUSE DRAWER. The two fuses that protect the AC input are located in this drawer. Please see the “FUSES” section of this manual for more information.
3. DC FUSES. These two fuses protect the internal DC power supplies. Please see the “FUSES” sections of this manual for more information.
4. GATE. This TTL-level (0 and +5V) logic input can be used to gate the triggering of the instrument. This input can be either active high or active low, depending on the front panel settings or programming commands. (The instrument triggers normally when this input is unconnected). When set to active high mode, this input is pulled-down to ground by a 1 k Ω resistor. When set to active low mode, this input is pulled-up to +5V by a 1 k Ω resistor.
5. TRIG. This TTL-level (0 and +5V) logic input can be used to trigger the instrument, if the instrument is set to triggering externally. The instrument triggers on the rising edge of this input. The input impedance of this input is 1 k Ω . (Depending on the length of cable attached to this input, and the source driving it, it may be desirable to add a coaxial 50 Ohm terminator to this input to provide a proper transmission line termination. The Pasternack (www.pasternack.com) PE6008-50 BNC feed-thru 50 Ohm terminator is suggested for this purpose.)
6. GPIB Connector. A standard GPIB cable can be attached to this connector to allow the instrument to be computer-controlled. See the “Programming Manual for -B Instruments” for more details on GPIB control.

7. RS-232 Connector. A standard serial cable with a 25-pin male connector can be attached to this connector to allow the instrument to be computer-controlled. See the “Programming Manual for -B Instruments” for more details on RS-232 control.
8. PULSE OUT CONNECTOR. This connector provides the pulse output signal to the test jig. This output should be connected to the corresponding input on the test jig using the supplied 60 cm coaxial cable.
9. CONTROL Connector. This DB-9 female connector should be connected to the corresponding connector on the test jig using the supplied DB-9 cable. This cable contains the safety interlock signals that ensure that the test jig lid is closed. The pinout is as follows:

Pin 1 - To test jig switch 1.

Pin 2 - To test jig switch 2.

Pin 3 - DUT DC forward bias current.

Pin 5 - Ground.

Pin 6 - To test jig switch 1.

Pin 7 - To test jig switch 2.

Pin 9 - Safety sensor power supply (+15V through 680 Ohms).

When the test jig lid is safely closed, Pin 1 is shorted to Pin 6, and Pin 2 is shorted to Pin 7.

TIMING CONTROL

MAINFRAME PULSE OUTPUT

This instrument can be triggered by its own internal clock or by an external TTL trigger signal. In either case, two pulse signals respond to the trigger: V_{PULSE} (on the mainframe OUT connector) and SYNC. The amplitude of V_{PULSE} is adjustable up to -24V. The pulse width is fixed at 200 ns. The SYNC pulse is a fixed-width TTL-level reference pulse used to trigger oscilloscopes or other measurement systems. When the delay is set to a positive value the SYNC pulse precedes the V_{PULSE} pulse. When the delay is set to a negative value the SYNC pulse follows the V_{PULSE} pulse.

These pulses are illustrated below, assuming internal triggering and a positive delay:

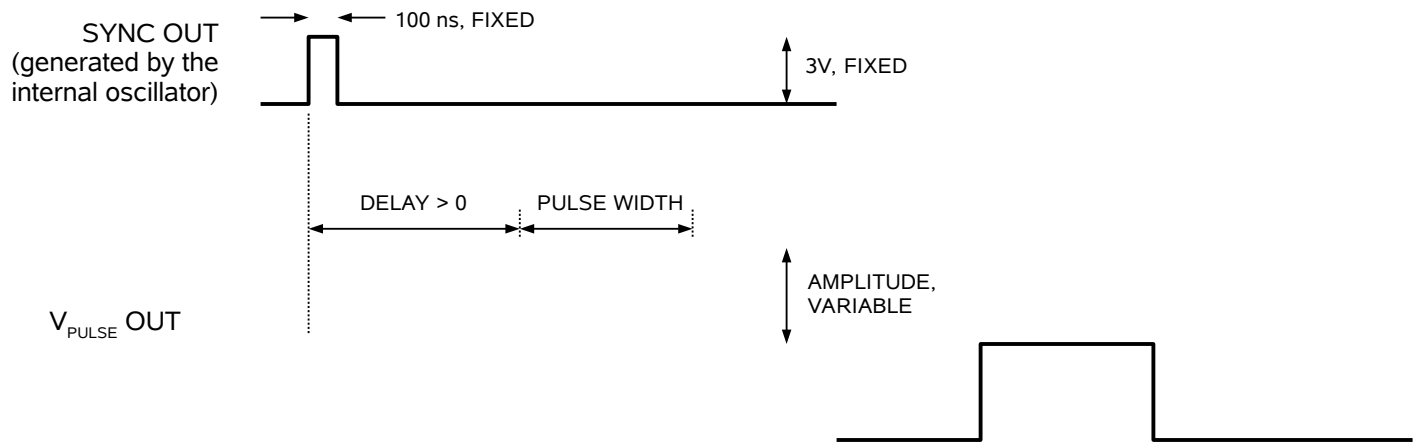

Figure A

If the delay is negative, the order of the SYNC and OUT pulses is reversed:

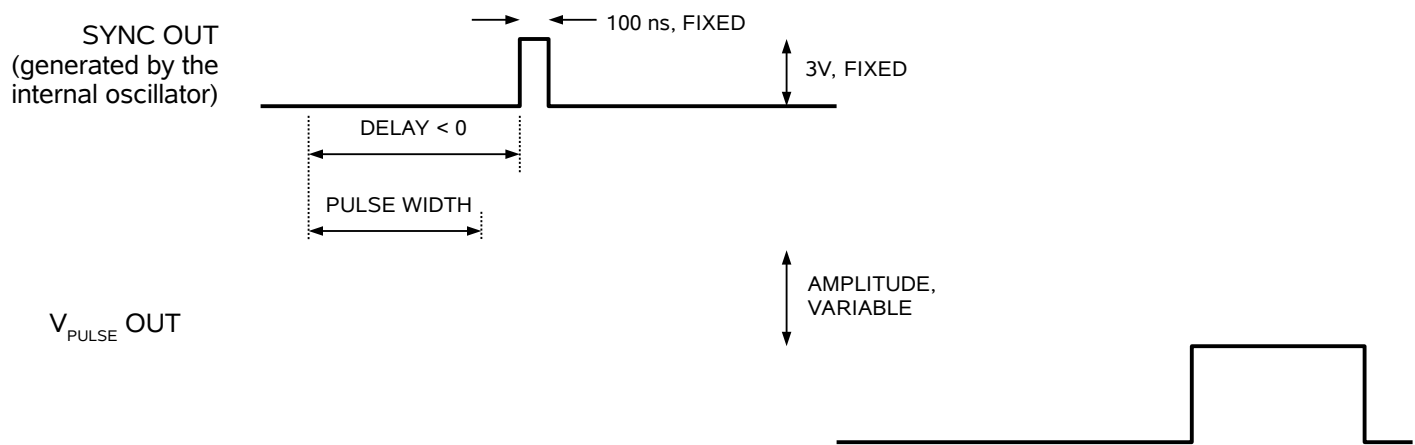

Figure B

The next figure illustrates the relationship between the signal when an external TTL-level trigger is used:

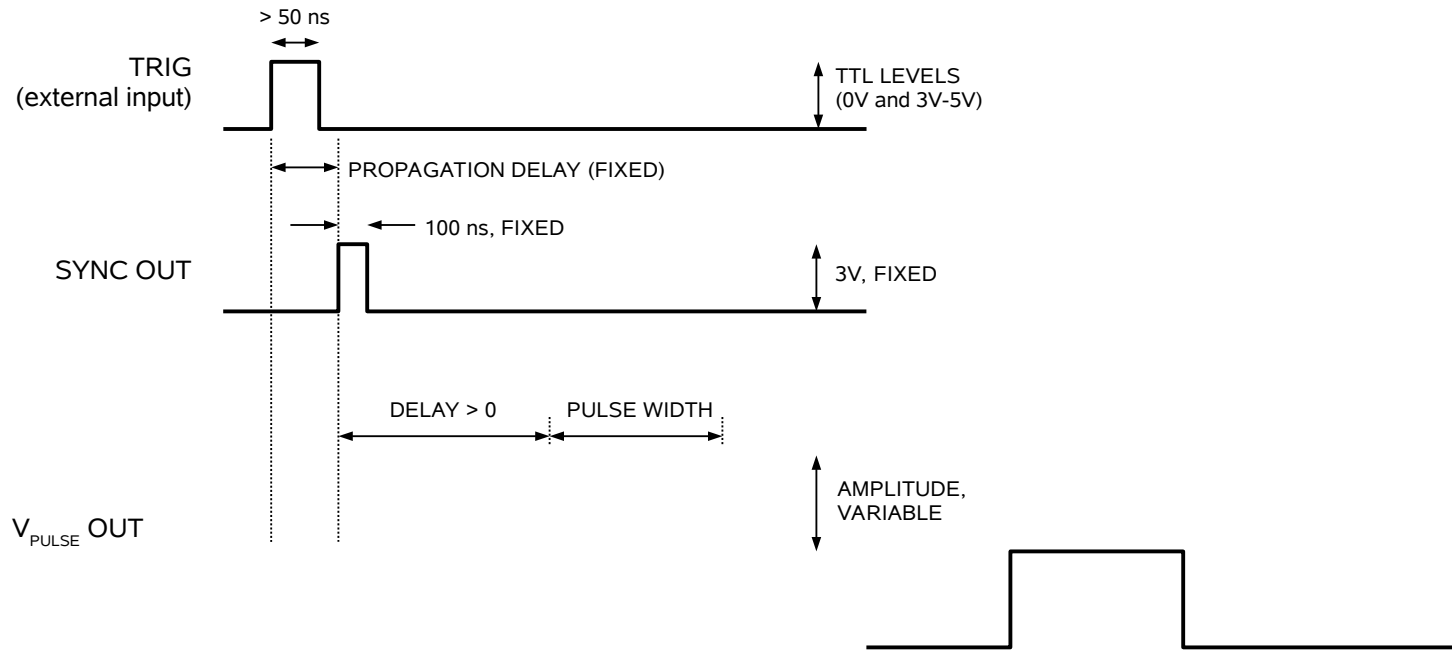

Figure C

As before, if the delay is negative, the order of the SYNC and OUT pulses is reversed.

The delay, pulse width, and frequency (when in the internal mode), of the OUT pulse can be varied with front panel controls or via the GPIB or RS-232 computer interfaces.

TRIGGER MODES

This instrument has four trigger modes:

- Internal Trigger: the instrument controls the trigger frequency, and generates the clock internally.
- External Trigger: the instrument is triggered by an external TTL-level clock on the back-panel TRIG connector.
- Manual Trigger: the instrument is triggered by the front-panel "SINGLE PULSE" pushbutton.

- Hold Trigger: the instrument is set to not trigger at all.

These modes can be selected using the front panel trigger menu, or by using the appropriate programming commands. (See the “Programming Manual for -B Instruments” for more details.)

GATING MODES

Triggering can be suppressed by a TTL-level signal on the rear-panel GATE connector. The instrument can be set to stop triggering when this input high or low, using the front-panel gate menu or the appropriate programming commands. When gated, the output will complete the full pulse width if the output is high, and then stop triggering. Pulses are not truncated.

BASIC AMPLITUDE CONTROL

The basic test arrangement for the AVR-EB2A-B is shown in the figure below. The OUT output on the instrument mainframe is connected to the IN input on the test jig (model AVX-CA-AR1, or a customized variant) using the supplied coaxial cable, and the control cable is connected using the supplied DB-9 cable.

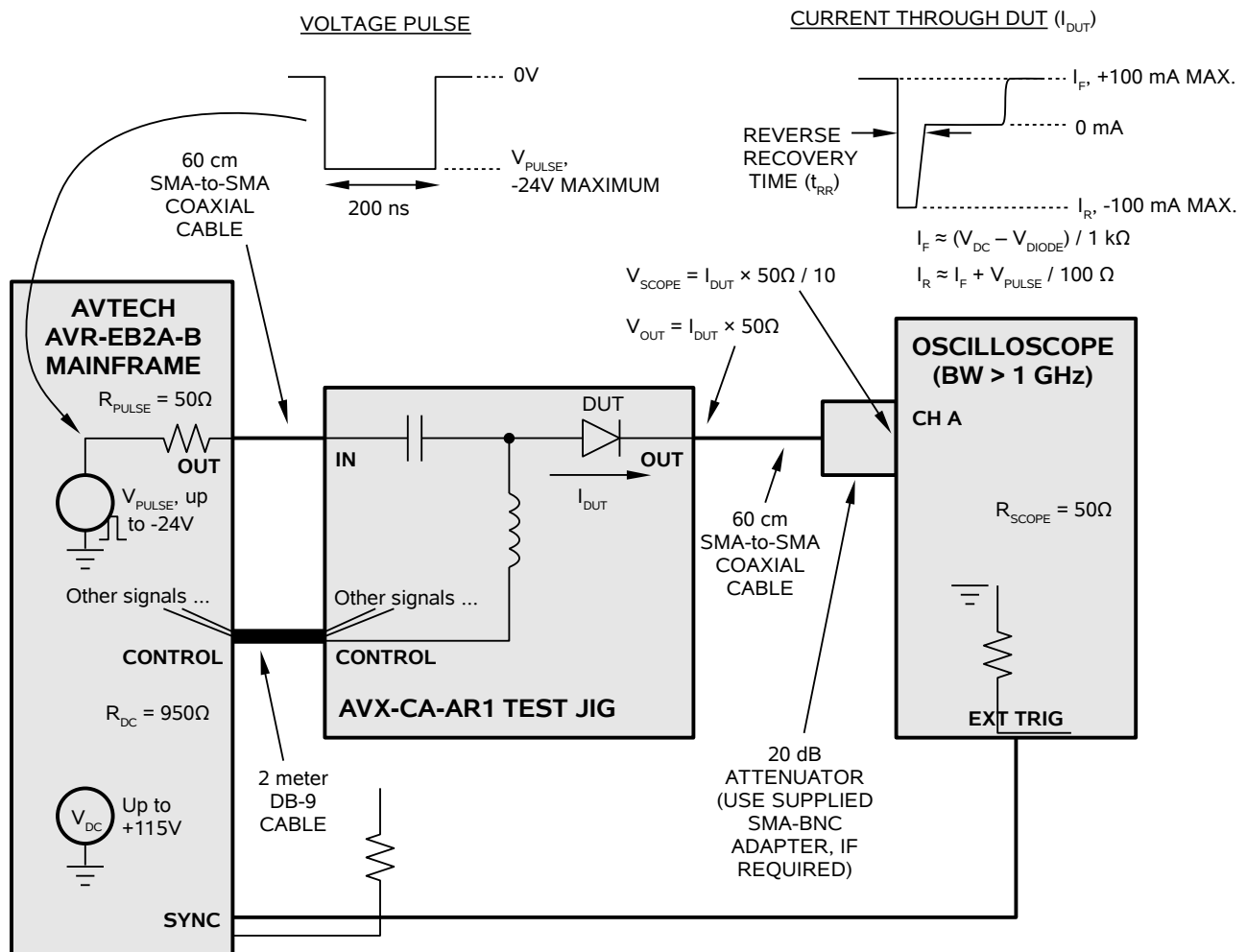

The OUT output on the test jig must be connected (using the supplied 60 cm SMA-to-SMA cable and 20 dB attenuator) to the 50 Ohm input of a high-bandwidth (> 1 GHz) user-supplied oscilloscope. The voltage on the output is proportional to the current through the DUT. By observing the current waveform through the DUT, the reverse recovery time may be determined. When connected as shown above, the oscilloscope voltage waveform is related to the device current by:

$$V_{SCOPE} = I_{DUT} \times 50\Omega / 10$$

This is the key equation for relating the observed voltage waveform to the DUT current.

SETTING THE AMPLITUDE LEVELS

The test jig contains a “bias tee” circuit to combine a DC forward bias with a reverse bias pulse.

An adjustable DC voltage of up to +115V is generated in the mainframe. This DC voltage is controlled by the front-panel OS menu, or by the “source:voltage:low” command. The DC voltage source has $R_{DC} = 950 \Omega$ in series with it, inside the mainframe. The DC forward bias current through the DUT is then given by:

$$I_F = (V_{DC} - V_{DIODE}) / (R_{DC} + R_{SCOPE})$$

$$I_F = (V_{DC} - V_{DIODE}) / 1000 \Omega$$

where V_{DIODE} is the diode forward voltage drop (typically 0.7V).

The reverse bias pulse is capacitively coupled “on top” of this DC bias current. The pulse generator has an adjustable amplitude of up to -24V, controlled by the front-panel AMP menu, or by the “source:voltage” command. The pulse generator has 50Ω in series with it, inside the mainframe, as well as the 50Ω of the oscilloscope, so the size of the current change will be $V_{PULSE} / (50 \Omega + 50 \Omega)$. Thus, the reverse current will given by:

$$I_R \approx I_F + V_{PULSE} / 100 \Omega$$

In this equation, I_F is positive, V_{PULSE} is negative, and V_{PULSE} must be set sufficiently high such that I_R is negative. This equation is only approximate, because the diode itself may introduce some poorly-defined parasitic resistance during the switching transient.

This basic arrangement of DC and pulse sources is specified by MIL-STD-750E Method 4031.4 Test Condition A.

AMPLITUDE ACCURACY

The amplitude settings *should not be relied upon for any degree of accuracy*, because the diode characteristics (forward voltage drop, reverse parasitic resistance) are not known accurately in advance. Instead the voltage at the OUT terminal on the test jig should be *measured* with a calibrated oscilloscope.

CURRENT MONITOR

The AVR-EB2A-B monitors the actual forward bias current through the DUT. If the DUT has been incorrectly seated, and the forward bias current can not flow properly, the

instrument will detect this problem, display an error message, and turn off the output. If this occurs, check the seating of the DUT and close both lids again.

The monitored forward current level is displayed on the front panel LCD, for the user's convenience. The accuracy is $\pm 2\% \pm 1 \text{ mA}$.

INCORRECT ORIENTATION

The instrument and the DUT will not be damaged if the diode is installed with the incorrect orientation (i.e., with the anode and cathode reversed). However, incorrect waveforms will be generated.

STANDARD TEST JIG MECHANICAL ASPECTS

One AVX-CA-AR1 test jig is normally supplied with the mainframe, unless the customer has requested a different or additional test jigs.

AVX-CA-AR1 TEST JIG

The standard AVX-CA-AR1 test jig has been designed to accept a variety of axial and SQMELF packages. It has been designed specifically to accept:

6. Microsemi "Type E" axial packages (used in the 1N5418 and other devices)
7. Generic DO-41 packages (used in the 1N5819 and other devices)
8. Microsemi Type A square MELF, also called D-5A (for example, 1N5806US)
9. Microsemi Type B square MELF, also called D-5D (for example, 1N6701US)
10. Microsemi Type E square MELF, also called D-5B (for example, 1N5811US)

To install a DUT, open the main (black) lid like this:



Then open the tan-colored DUT socket by flipping forward the two black latches on the front edge of it:



Insert a diode into one of the 4 “pockets”. The two gold contact pins are visible in each pocket; the device must be aligned with these pins. A DO-41 package is shown installed below:



Or, shown in a closer view:

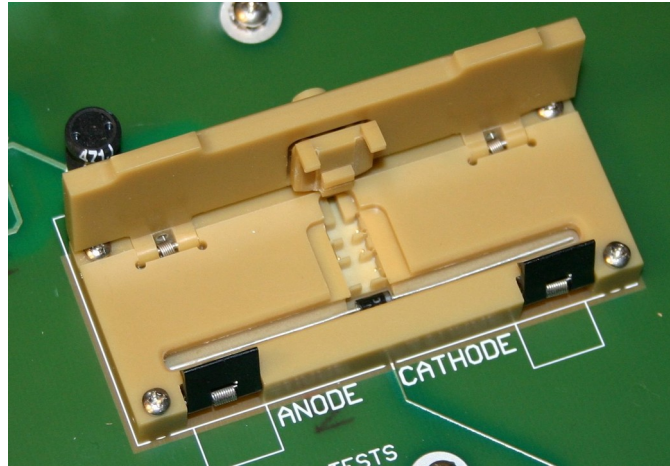

The remaining photos shown the different types of SQMELF packages installed:

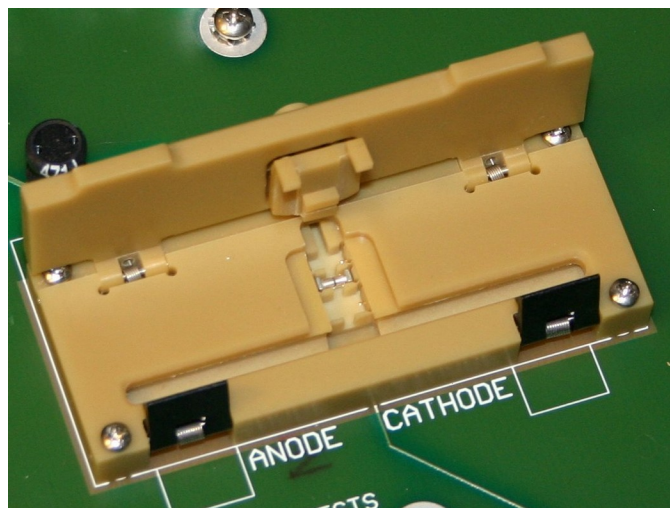
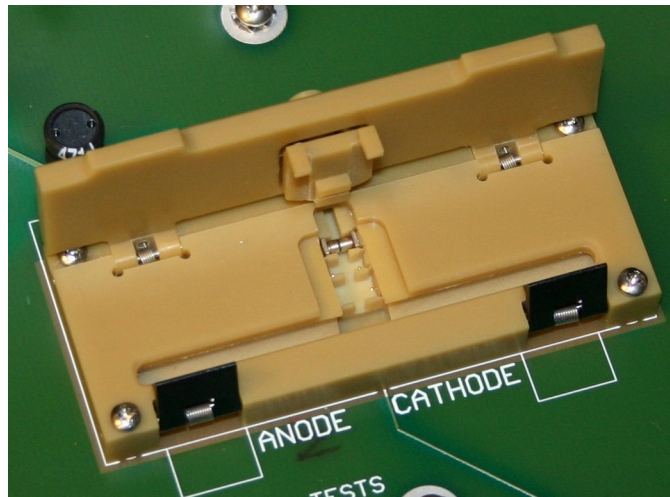

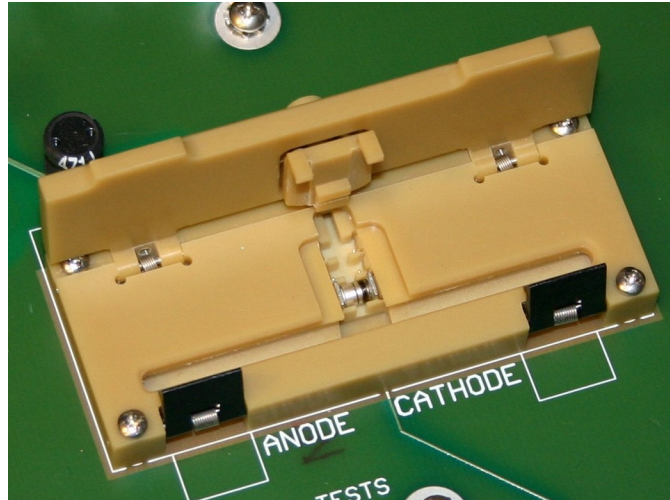

The four pockets are wired in parallel. Only one DUT may be installed at a time, or the resulting waveforms will be incorrect.

Once the DUT is installed in the appropriate pocket, close the tan-colored socket lid and the black main lid. Both must be closed for proper operation.

The AVR-EB2A-B monitors the actual forward bias current through the DUT. If the DUT has been incorrectly seated, and the forward bias current can not flow properly, the instrument will detect this problem, display an error message, and turn off the output. If this occurs, check the seating of the DUT and close both lids again.

The instrument and the DUT will not be damaged if the diode is installed with the incorrect orientation (i.e., with the anode and cathode reversed). However, incorrect waveforms will be generated.

The IN, OUT, and CONTROL connectors are on the rear of the jig, below the hinges:



REPLACEMENT SOCKETS

The tan-colored DUT socket in the AVX-CA-AR1 is a special-order Aries Electronics (<http://www.arieselec.com>) part, part number 9890-122-23. The socket may be replaced by unscrewing the four screws that hold down the main green circuit board, and then flipping the circuit board upwards. The four screws that hold the socket against the circuit board can then be removed, allowing the socket to be replaced. The underside of the socket has coiled springs that contact gold pads on the circuit board.

CUSTOMIZED TEST JIGS

AVX-CA-KMPB-TO39

The AVX-CA-KMPB-TO39 accepts diodes in three-pin TO-39 packages. The anode and cathode must be opposite each other across the center of the package. The anode-to-cathode pin spacing is 0.2" (or 5.08 mm). Pin sockets are provided for the anode and cathode pins. Two clearance holes (rather than a pin socket) are provided to accommodate the third pin.

The method of connecting the AVX-CA-KMPB-TO39 test jig to the pulse mainframe and to the oscilloscope is identical to that for the standard test jig (the AVX-CA-AR1, described in the previous section).

The pin socket area is shown below:



The next photo show an installed DUT.



TYPICAL RESULTS

Obtaining meaningful results with the AVR-EB2A-B requires care, experience, and an understanding of diode transient behavior and the impact of inductive and capacitive parasitics. To assist the user, typical results for commercially available diodes are provided below. The user should be able to reliably duplicate these results.

1N4148 RESULTS

The 1N4148 is a common high-speed low-current switching diode, whose specification are specified in the military “slash sheet” MIL-PRF-19500/116R . This sheet calls for a maximum t_{RR} of 5 ns when measured with $I_F = +10$ mA and $I_R = -10$ mA, measuring t_{RR} at -1 mA. Using the AVR-EB2A-B under these conditions, the following waveform is obtained:

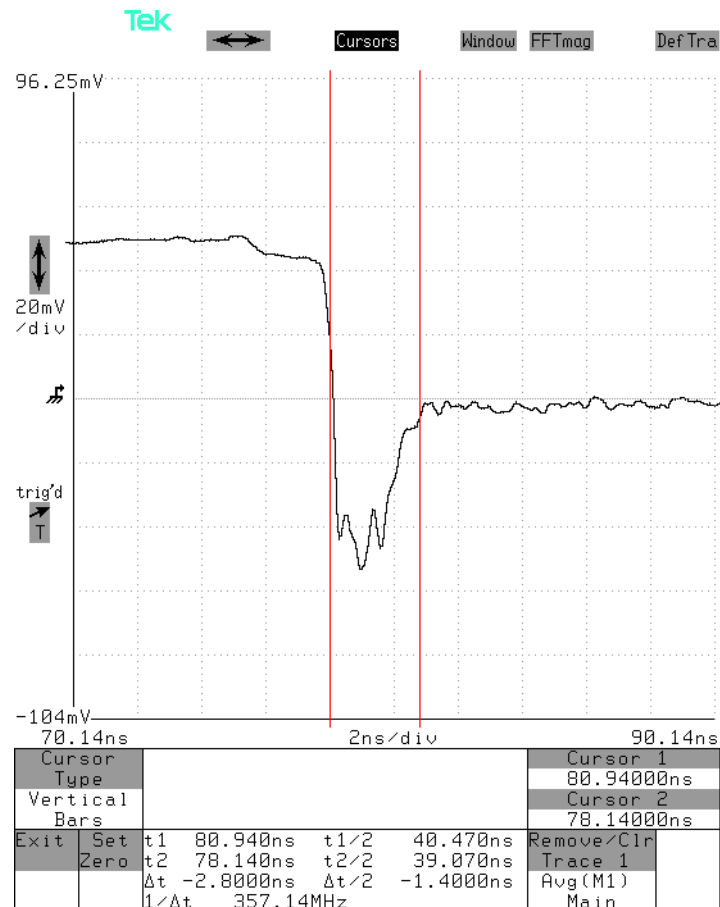

The measured t_{RR} is 2.8 ns, well below the maximum specified value of 5 ns. The vertical scale of 20 mV/div corresponds to a device current scale of 4 mA / div. Some ringing is observed, due to transmission line reflections. These are unavoidable.

If the test currents are boosted by a factor of ten to +100 mA and -100 mA, the t_{RR} increases to 7.6 ns:

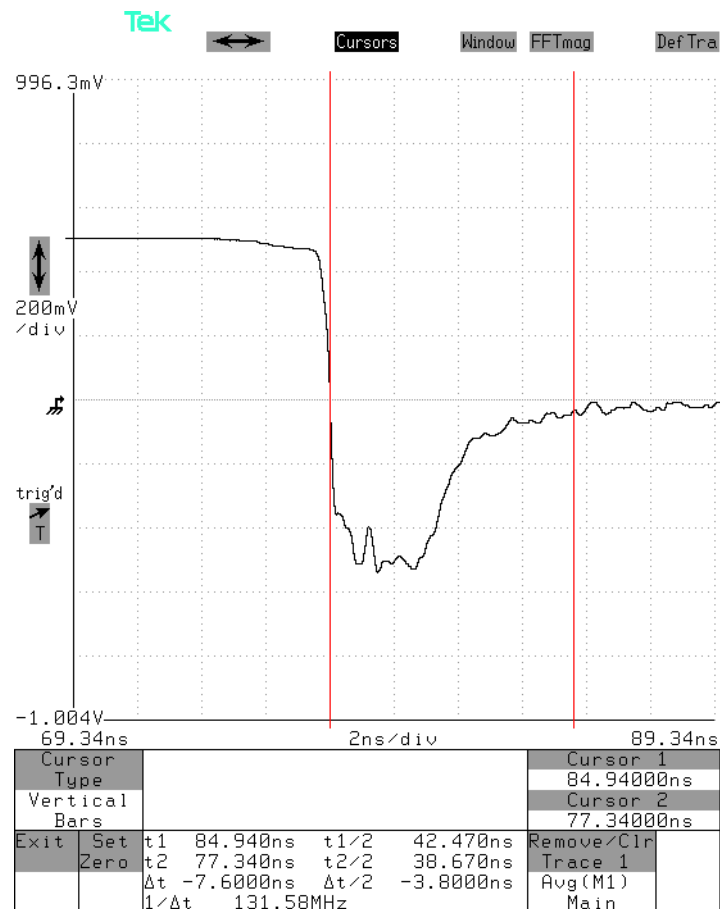

The installed DUT is shown below:

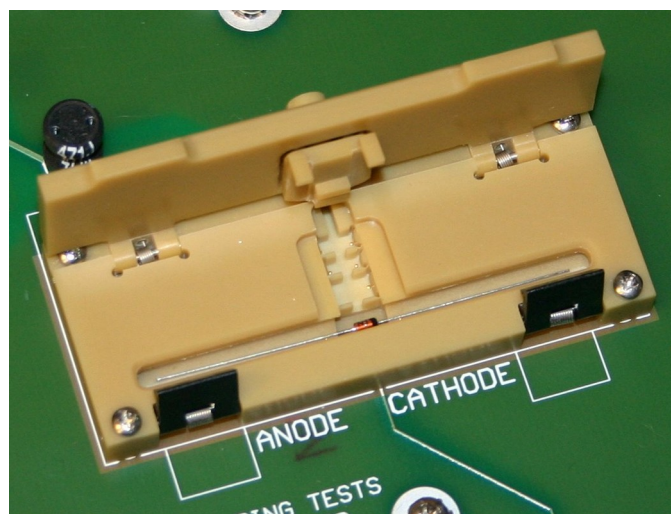

MQ1N5811US RESULTS

The military-qualified MQ1N5811US is a high-speed higher-current rectifier in a Microsemi Type E square MELF package (also known as the D-5B package). Testing with $I_F = +10 \text{ mA}$ and $I_R = -10 \text{ mA}$ yields a t_{RR} of 86 ns:

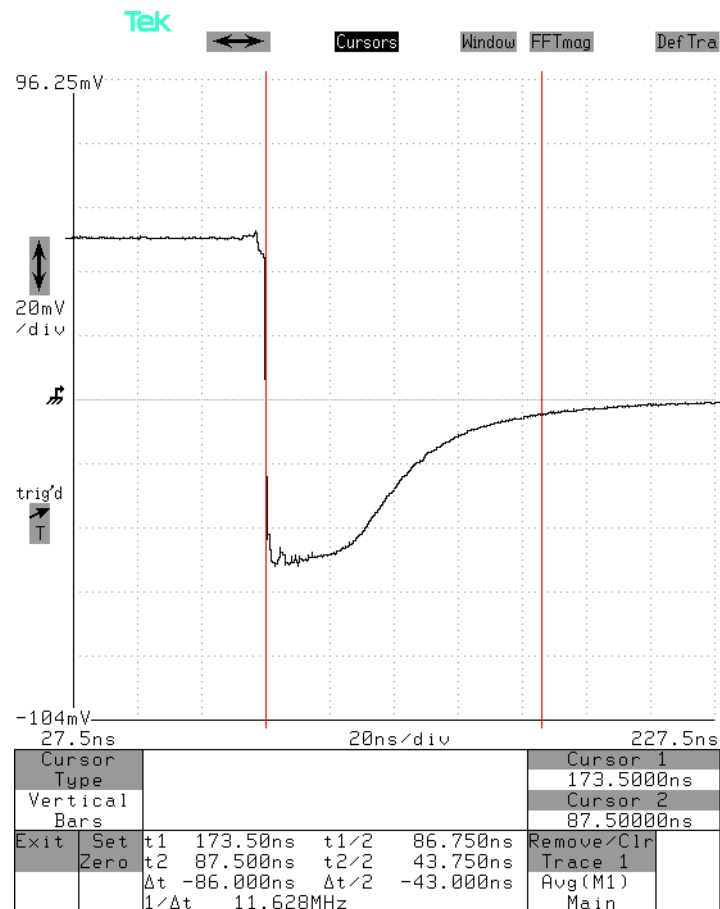

If the test currents are boosted by a factor of ten to +100 mA and -100 mA, the t_{RR} decreases to 53 ns:

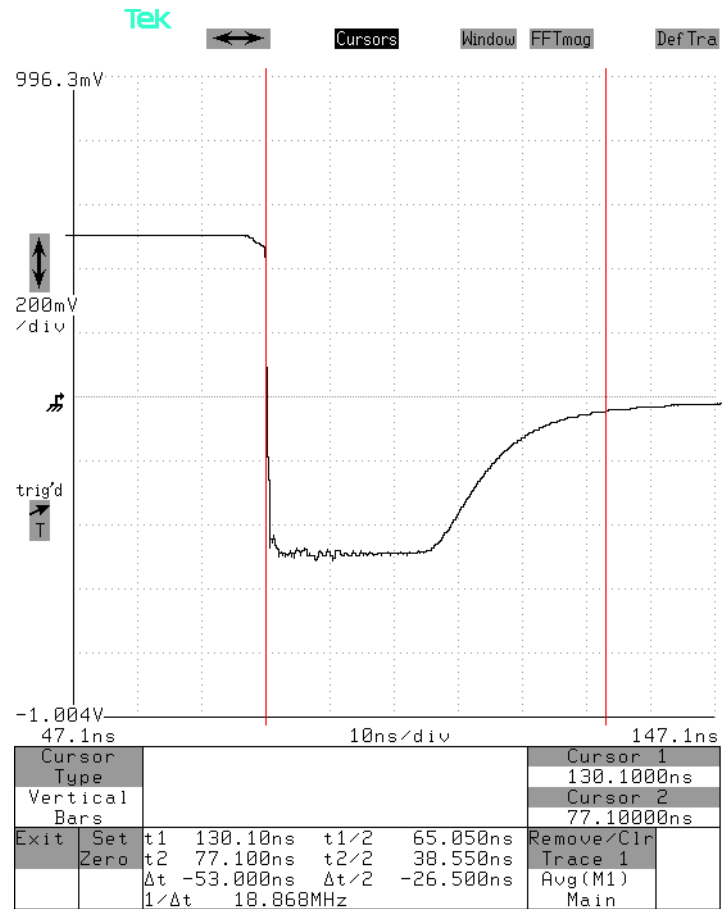

The installed DUT is shown below:

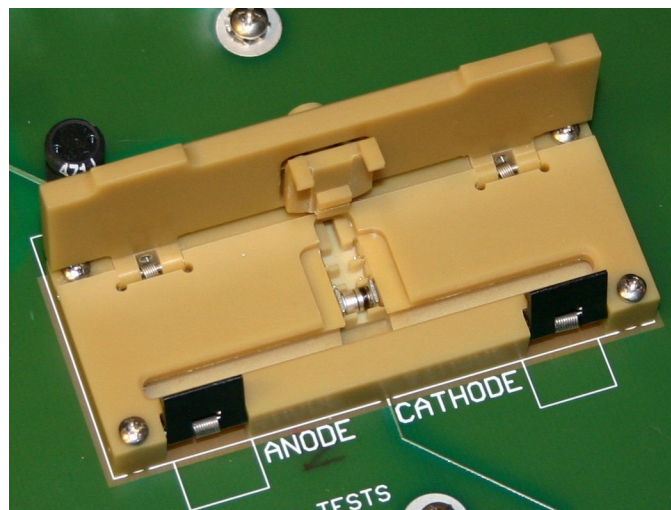

1N5819 RESULTS

The 1N5819 is a DO-41 axial-packaged Schottky rectifier. Testing with $I_F = +10 \text{ mA}$ and $I_R = -10 \text{ mA}$ yields a t_{RR} of 35 ns:

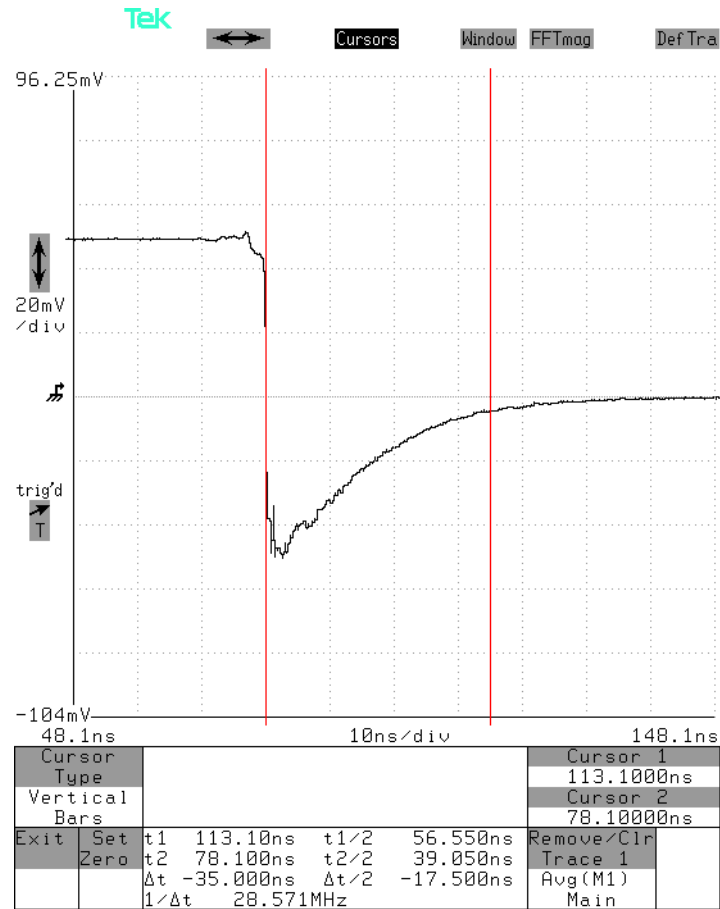

If the test currents are boosted by a factor of ten to +100 mA and -100 mA, the t_{RR} decreases to 14 ns:

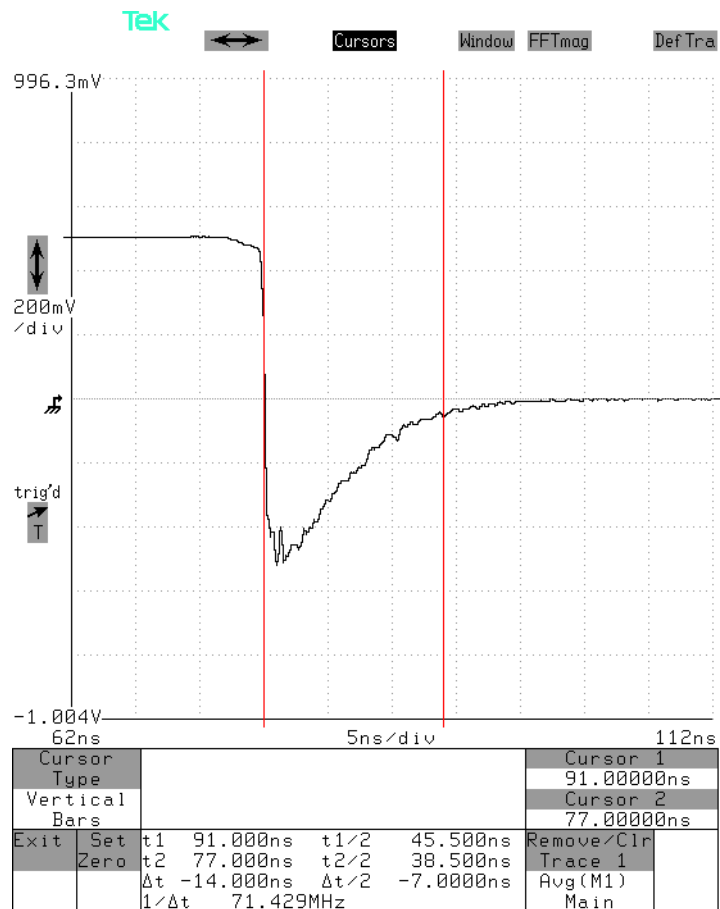

The installed DUT is shown below:

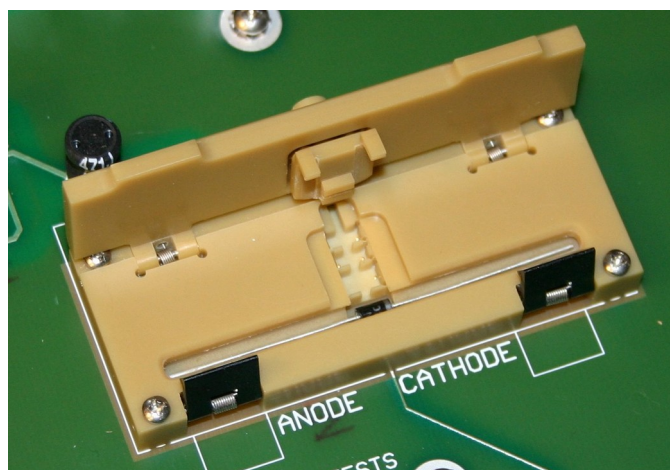

WITH NO DUT

If a piece of busbar wire is installed in the axial pocket, the basic speed of the test socket may be judged. With $I_F = +100$ mA and $I_R = -100$ mA, a 10%-90% switching time of 709 ps observed:



The inductance of the busbar and the socket degrades the transition time of the pulse from the mainframe. If the mainframe OUT is fed directly into an oscilloscope (bypassing the test jig), transition times of less than 200 ps are observed:

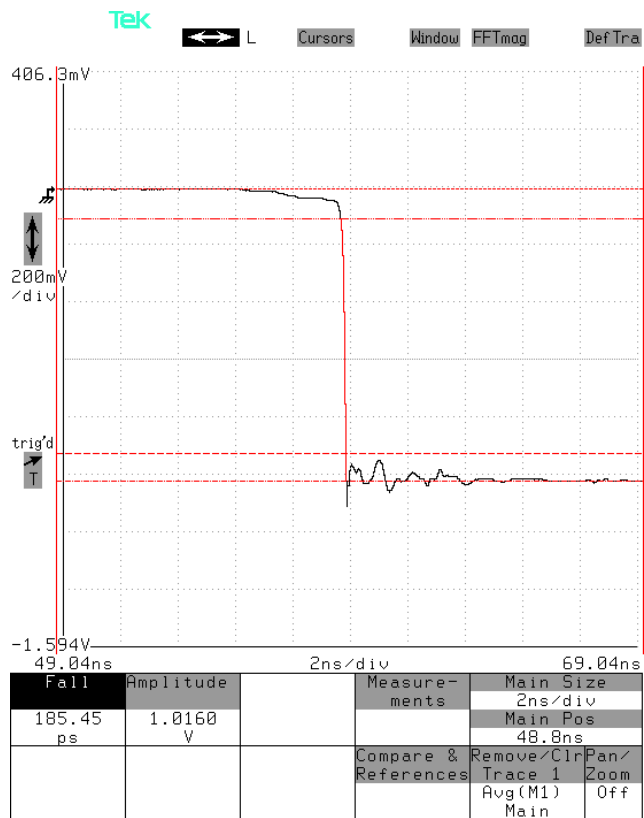

It is still below 300 ps at +10 mA / -10 mA as well:

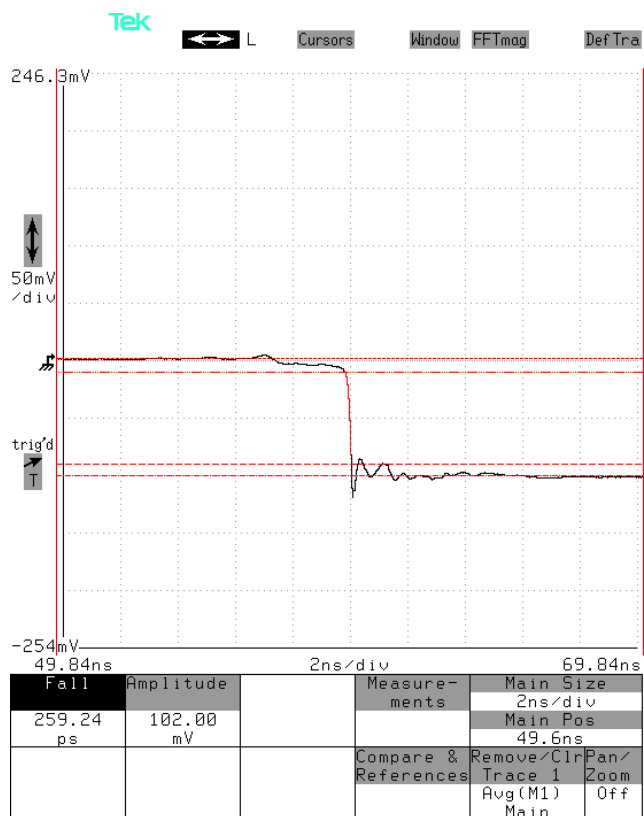

TROUBLESHOOTING

If you obtain “strange” output waveforms, or unexpected values of t_{RR} , keep these points in mind:

- 1) The test jig output *must* be terminated with 50 Ohms. This is normally the input impedance of the oscilloscope, or the oscilloscope / attenuator combination.
- 2) An attenuator may be required on the oscilloscope to avoid overdriving the oscilloscope input, especially for sampling oscilloscopes.
- 3) The coaxial cable connecting the test jig to the output module should normally be as short as possible (60 cm or less).
- 4) If reflections are observed on the output waveform, increase the length of the coaxial cable connecting the test jig to the output module so that the reflections do not overlap with the reverse transient. This will probably not change the measured value, but it will keep the two effects isolated (the reverse transient and the reflections), for greater measurement confidence.
- 5) The test jig lid must be closed, or the pulser output will be disabled.

For technical support, contact info@avtechpulse.com. Sample waveforms and digital photos of your setup are always helpful!

PROGRAMMING YOUR PULSE GENERATOR

KEY PROGRAMMING COMMANDS

The “Programming Manual for -B Instruments” describes in detail how to connect the pulse generator to your computer, and the programming commands themselves. A large number of commands are available; however, normally you will only need a few of these. Here is a basic sample sequence of commands that might be sent to the instrument after power-up:

*rst	(resets the instrument)
trigger:source internal	(selects internal triggering)
frequency 1000 Hz	(sets the frequency to 1000 Hz)
pulse:delay 50 ns	(sets the delay to 50 ns)
volt:low +100V	(sets the DC voltage to +100V, and thus $I_F \approx +100$ mA)
volt -20V	(sets the pulse voltage to -20V, and thus $I_R \approx -100$ mA)
output on	(turns on the output)

For triggering a single event, this sequence would be more appropriate:

*rst	(resets the instrument)
trigger:source hold	(turns off all triggering)
output on	(turns on the output)
pulse:delay 50 ns	(sets the delay to 50 ns)
volt:low +100V	(sets the DC voltage to +100V, and thus $I_F \approx +100$ mA)
volt -20V	(sets the pulse voltage to -20V, and thus $I_R \approx -100$ mA)
trigger:source immediate	(generates a single non-repetitive trigger event)
trigger:source hold	(turns off all triggering)
output off	(turns off the output)

To set the instrument to trigger from an external TTL signal applied to the rear-panel TRlg connector, use:

*rst	(resets the instrument)
trigger:source external	(selects external triggering)
pulse:delay 50 ns	(sets the delay to 50 ns)
volt:low +100V	(sets the DC voltage to +100V, and thus $I_F \approx +100$ mA)
volt -20V	(sets the pulse voltage to -20V, and thus $I_R \approx -100$ mA)
output on	(turns on the output)

These commands will satisfy 90% of your programming needs.

ALL PROGRAMMING COMMANDS

For more advanced programmers, a complete list of the available commands is given below. These commands are described in detail in the “Programming Manual for -B Instruments”. (Note: this manual also includes some commands that are not implemented in this instrument. They can be ignored.)

<u>Keyword</u>	<u>Parameter</u>	<u>Notes</u>
LOCAL		
MEASure:		
:AMPLitude?		[query only]
OUTPut:		
:[STATe]	<boolean value>	
:PROTection		
:TRIPped?		[query only]
REMOTE		
[SOURce]:		
:FREQuency		
[:CW FIXed]	<numeric value>	
[SOURce]:		
:PULSe		
:PERiod	<numeric value>	
:WIDTh	<numeric value>	
:DELay	<numeric value>	
:GATE		
:LEVel	High Low	
[SOURce]:		
:VOLTage		
[:LEVel]		
[:IMMEDIATE]		
[:AMPLitude]	<numeric value>	
:LOW	<numeric value>	
:PROTection		
:TRIPped?		[query only]
STATUS:		
:OPERation		
:[EVENT]?		[query only, always returns "0"]
:CONDition?		[query only, always returns "0"]
:ENABle	<numeric value>	[implemented but not useful]
:QUEStionable		
:[EVENT]?		[query only, always returns "0"]
:CONDition?		[query only, always returns "0"]
:ENABle	<numeric value>	[implemented but not useful]
SYSTem:		
:COMMunicate		
:GPIB		
:ADDReSS	<numeric value>	
:SERial		
:CONTRol		
:RTS	ON IBFull RFR	
:[RECeive]		
:BAUD	1200 2400 4800 9600	
:BITS	7 8	
:ECHO	<boolean value>	
:PARity		

	: [TYPE]	EVEN ODD NONE	
	: SBITS	1 2	
:ERRor			
:[NEXT]?			[query only]
:COUNT?			[query only]
:VERSion?			[query only]
TRIGger:			
:SOURce		INTernal EXTernal MANual HOLD IMMEDIATE	
*CLS			[no query form]
*ESE		<numeric value>	
*ESR?			[query only]
*IDN?			[query only]
*OPC			
*SAV		0 1 2 3	[no query form]
*RCL		0 1 2 3	[no query form]
*RST			[no query form]
*SRE		<numeric value>	
*STB?			[query only]
*TST?			[query only]
*WAI			[no query form]

MECHANICAL INFORMATION

TOP COVER REMOVAL

If necessary, the interior of the instrument may be accessed by removing the four Phillips screws on the top panel. With the four screws removed, the top cover may be slid back (and off).

 Always disconnect the power cord and allow the instrument to sit unpowered for 10 minutes before opening the instrument. This will allow any internal stored charge to discharge.

There are no user-adjustable internal circuits. For repairs other than fuse replacement, please contact Avtech (info@avtechpulse.com) to arrange for the instrument to be returned to the factory for repair. Service is to be performed solely by qualified service personnel.

 Caution: High voltages are present inside the instrument during normal operation. Do not operate the instrument with the cover removed.

RACK MOUNTING

A rack mounting kit is available. The -R5 rack mount kit may be installed after first removing the one Phillips screw on the side panel adjacent to the front handle.

ELECTROMAGNETIC INTERFERENCE

To prevent electromagnetic interference with other equipment, all used outputs should be connected to shielded loads using shielded coaxial cables. Unused outputs should be terminated with shielded coaxial terminators or with shielded coaxial dust caps, to prevent unintentional electromagnetic radiation. All cords and cables should be less than 3m in length.

MAINTENANCE

REGULAR MAINTENANCE

This instrument does not require any regular maintenance.

On occasion, one or more of the four rear-panel fuses may require replacement. All fuses can be accessed from the rear panel. See the “FUSES” section for details.

CLEANING

If desired, the interior of the instrument may be cleaned using compressed air to dislodge any accumulated dust. (See the “TOP COVER REMOVAL” section for instructions on accessing the interior.) No other cleaning is recommended.

WIRING DIAGRAMS

WIRING OF AC POWER

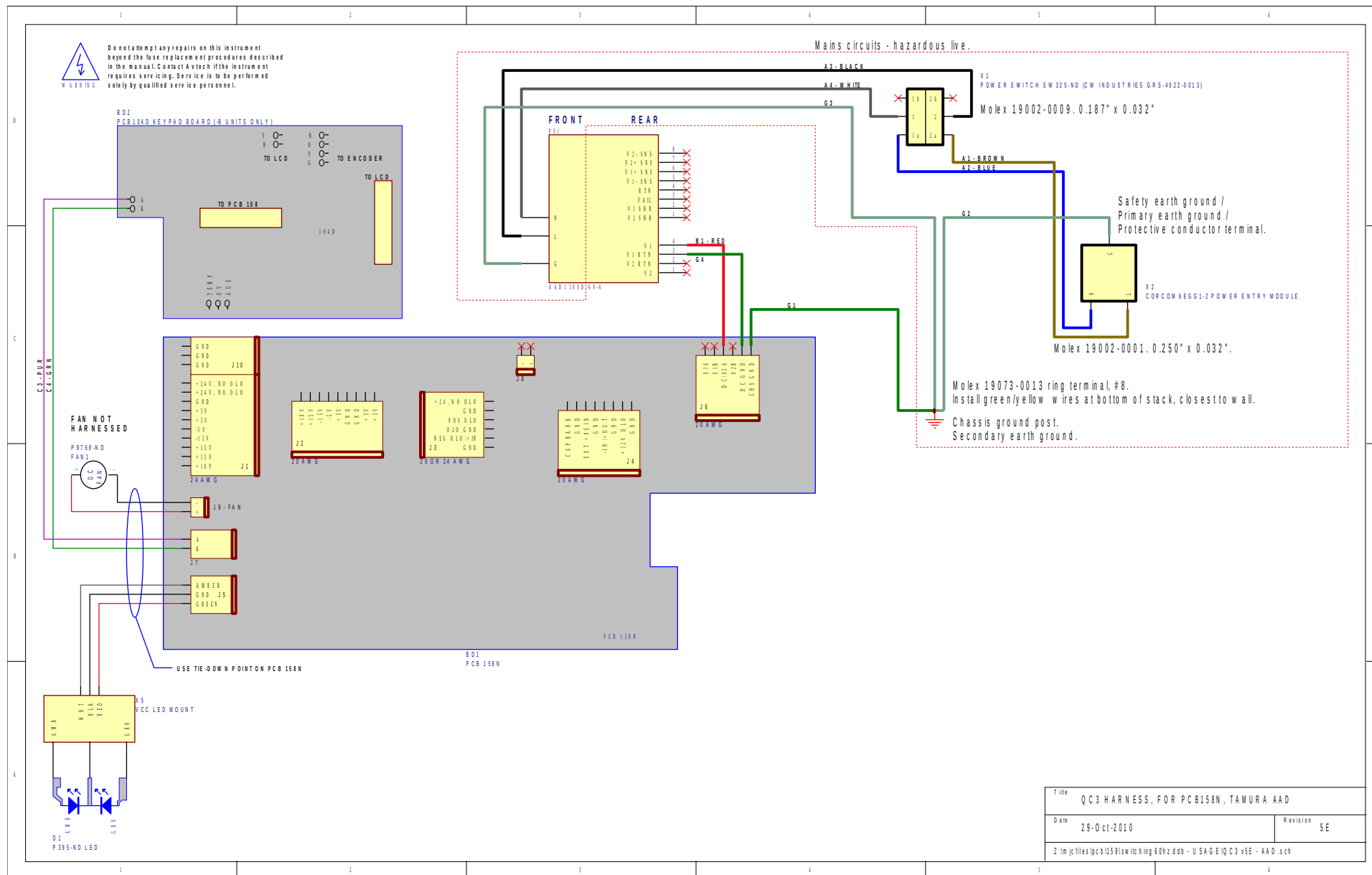

PCB 158N - LOW VOLTAGE POWER SUPPLY, 1/3

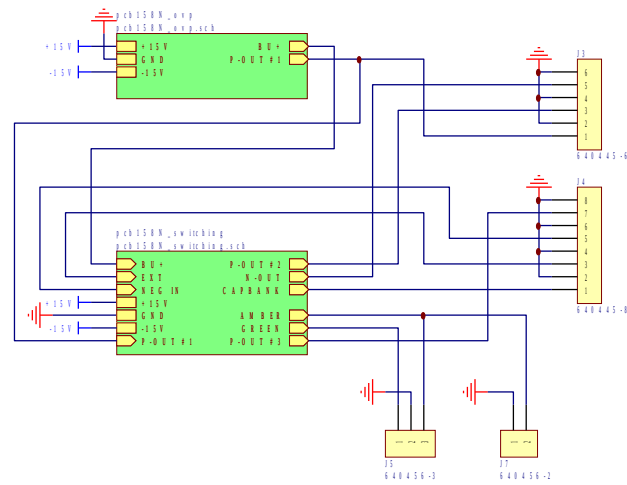

Title		LOW VOLTAGE DC/DC POWER SUPPLY
Date	12-Dec-2008	Revision
Z:\lm\jcf\files\pcb\158\switching\60hz.ddb - 158N\ipc0158N.sch		

PCB 168B - HIGH VOLTAGE DC POWER SUPPLY

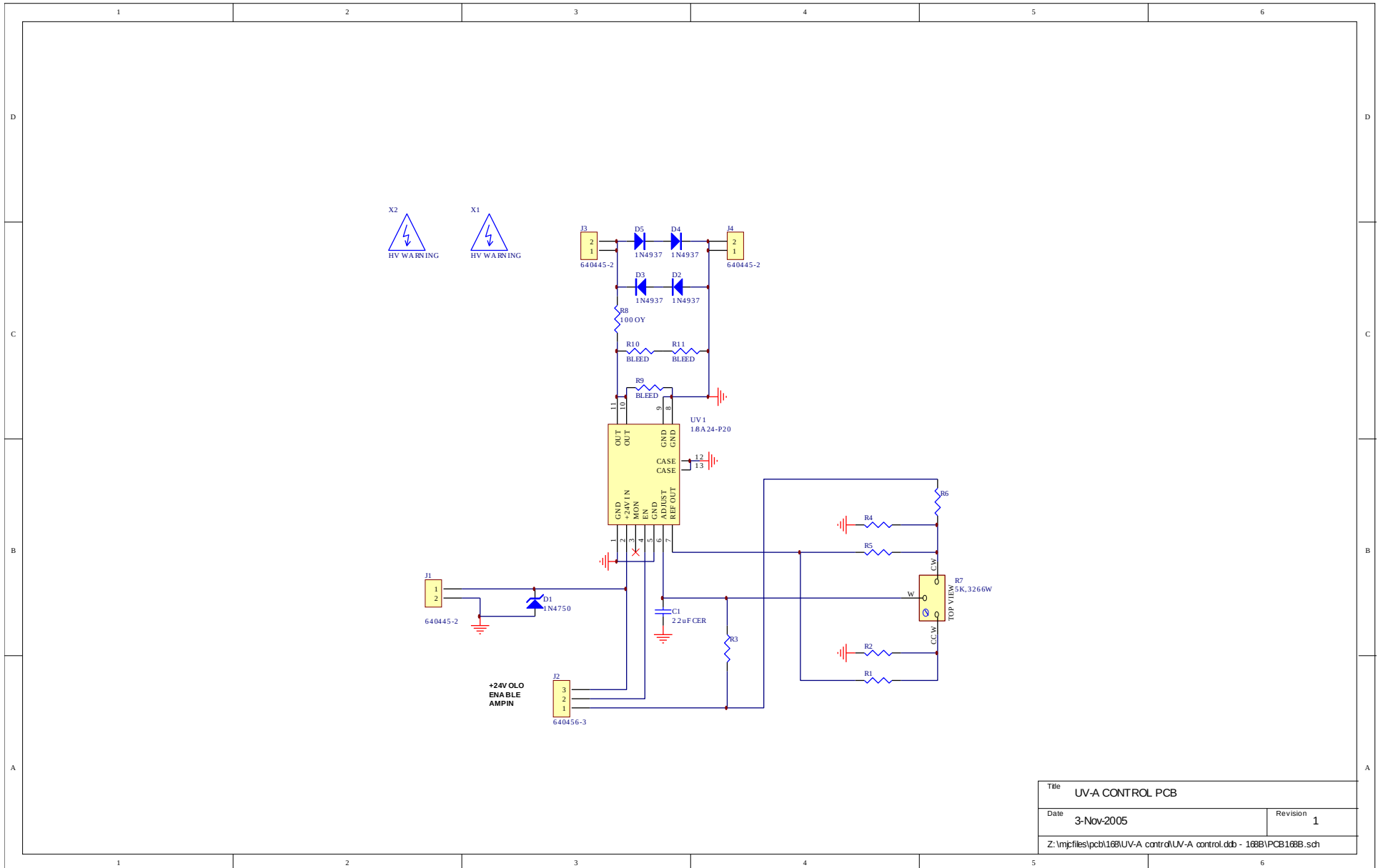

Title UV-A CONTROL PCB	
Date 3-Nov-2005	Revision 1
Z:\mpjfiles\pcb168\UV-A control\UV-A control.ddb - 168B\PCB168B.sch	

PCB 116C - CURRENT MONITOR

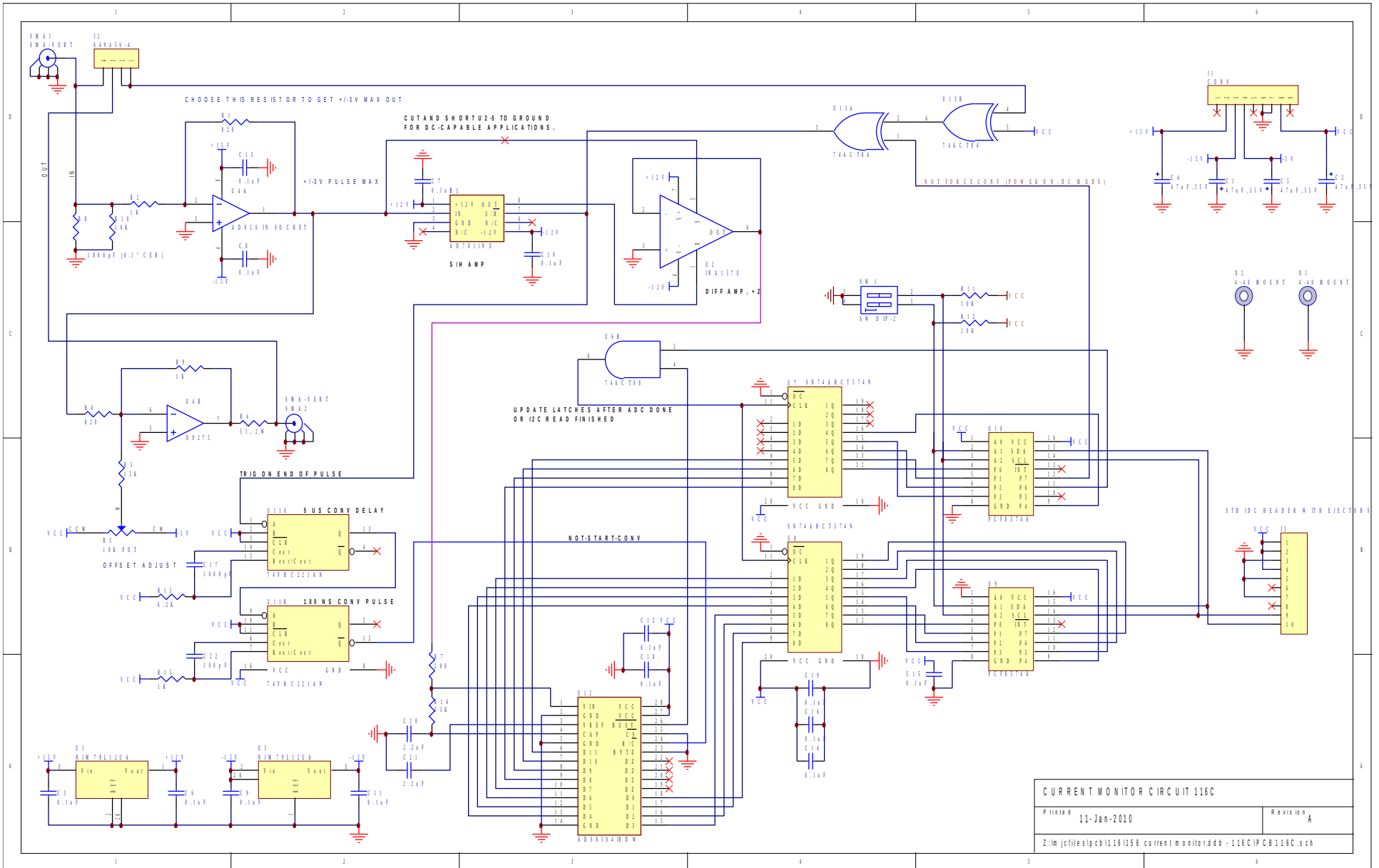

PCB 104D - KEYPAD / DISPLAY BOARD, 1/3

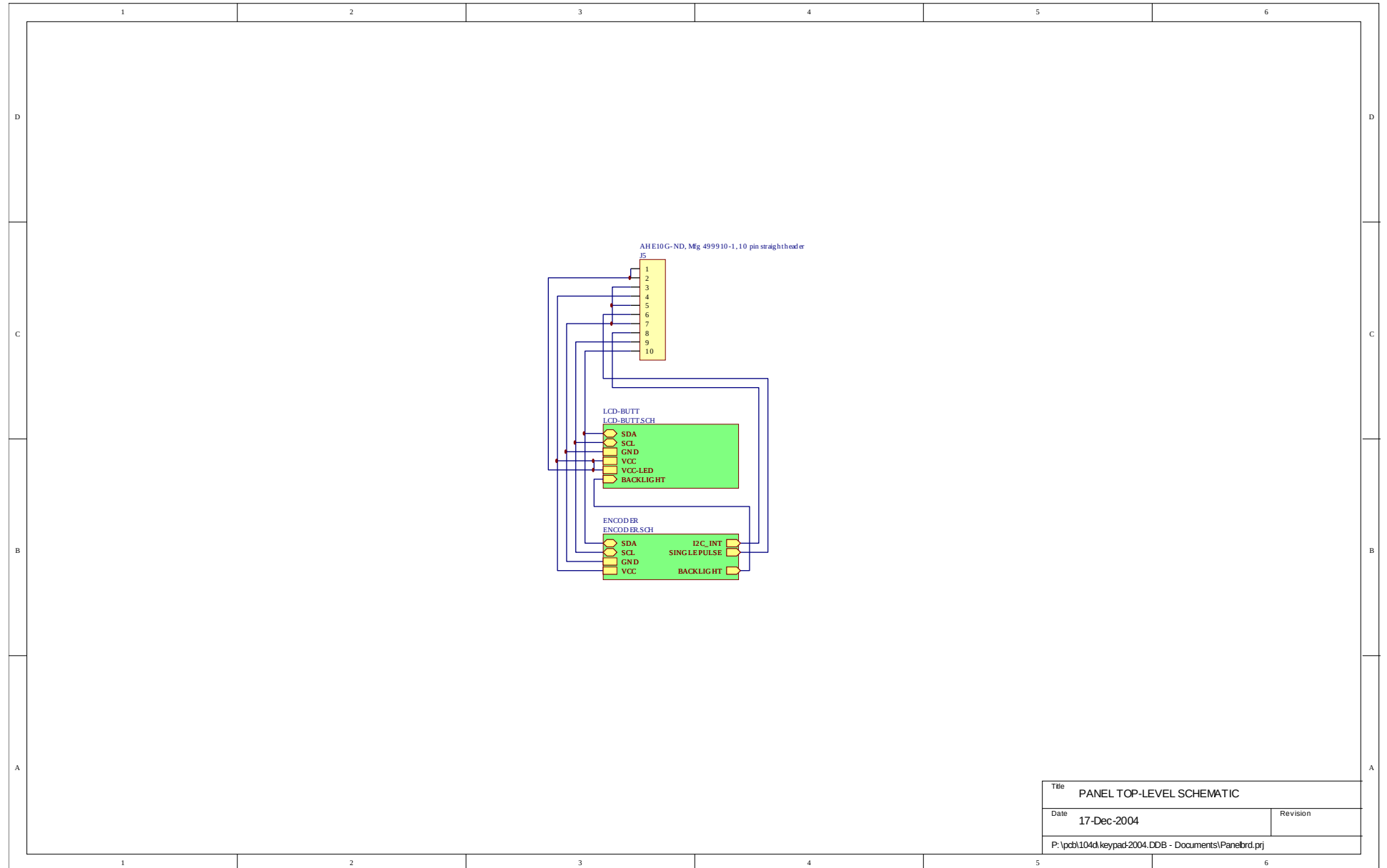

PCB 104D - KEYPAD / DISPLAY BOARD, 2/3

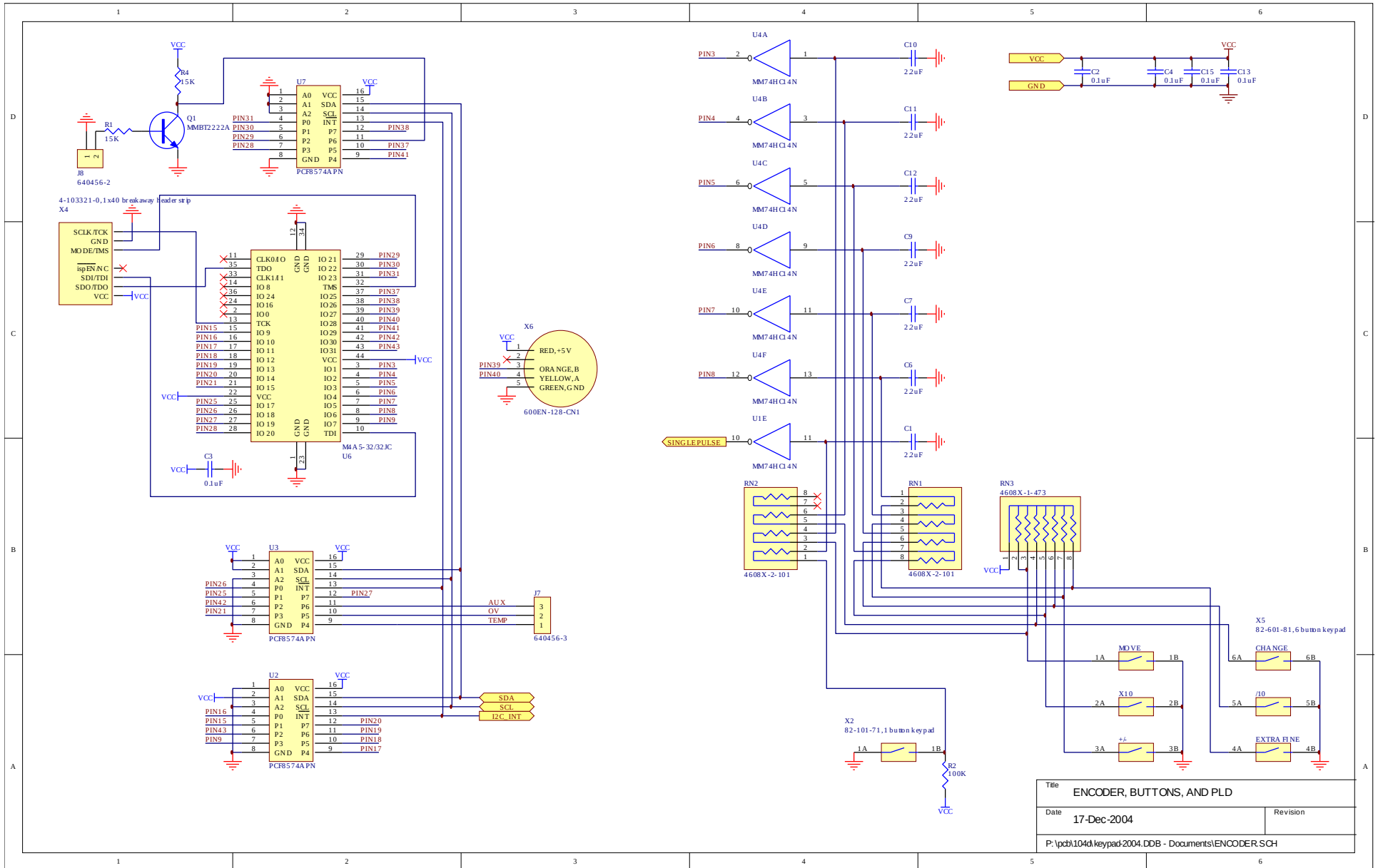

PCB 104D - KEYPAD / DISPLAY BOARD, 3/3

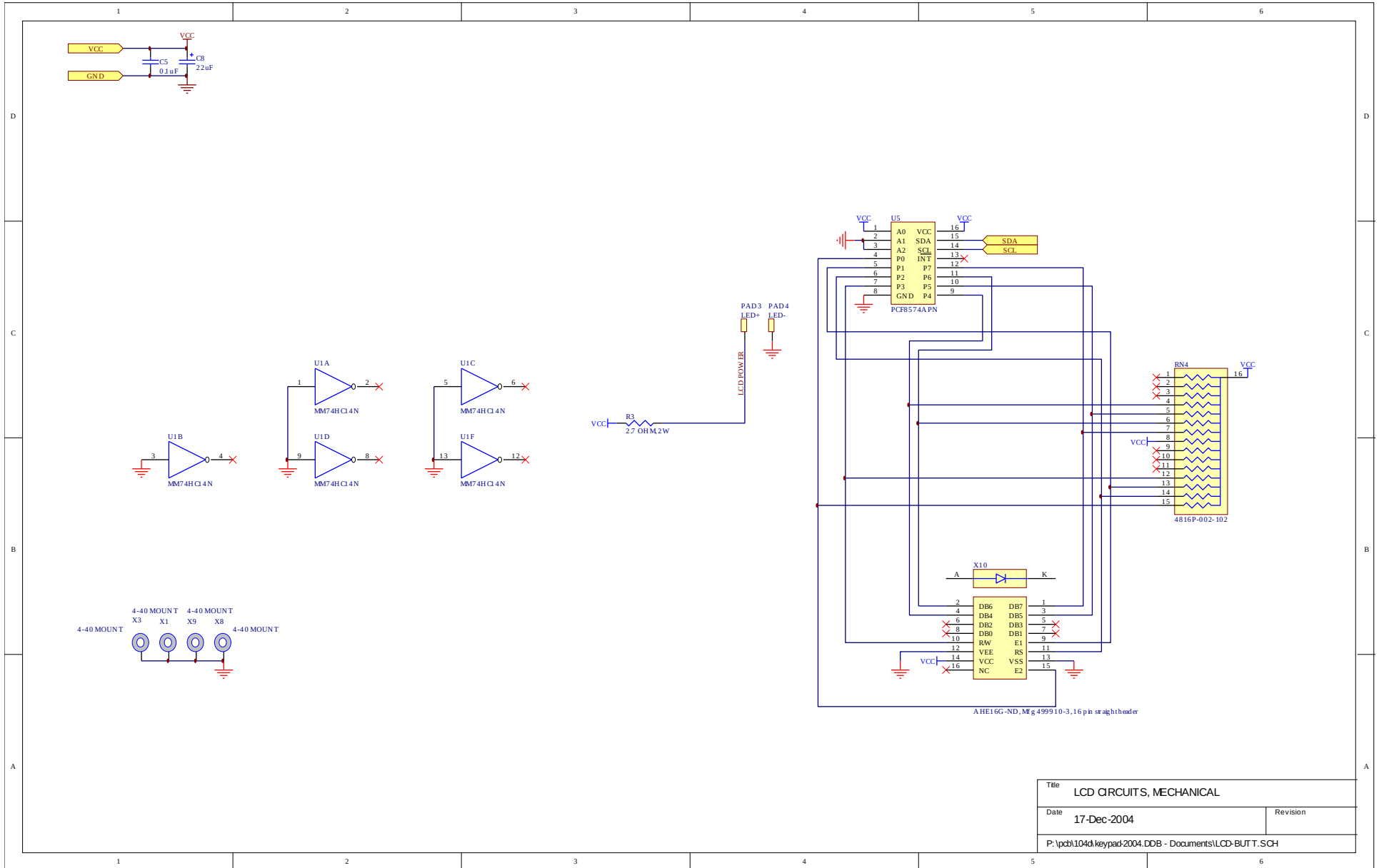

Title		LCD CIRCUITS, MECHANICAL	
Date	17-Dec-2004	Revision	
P:\pcb\104d\keypad2004.DDB - Documents\LCD-BUTT.SCH			

MAIN WIRING

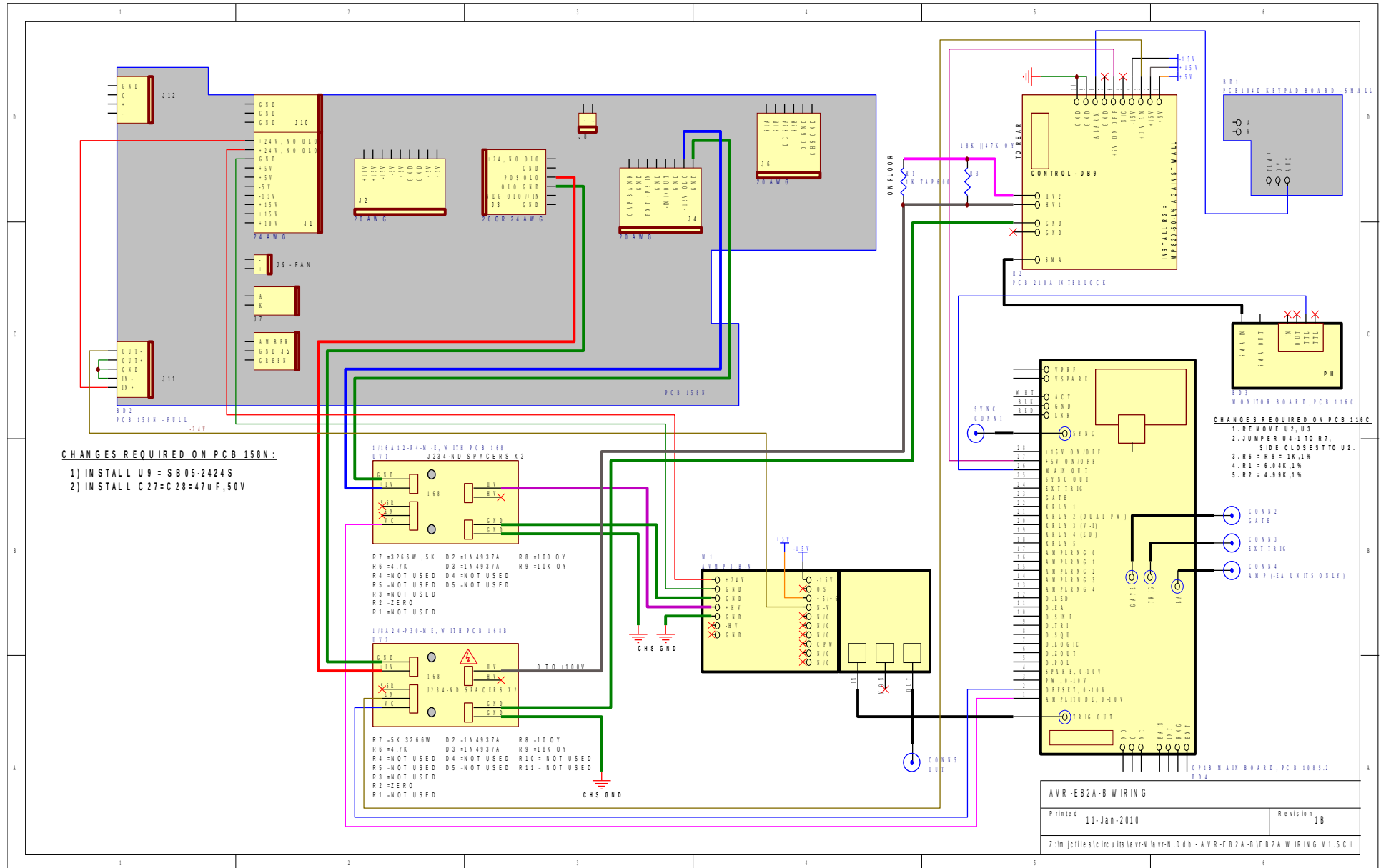

STANDARD TEST JIG WIRING (AVX-CA-AR1)

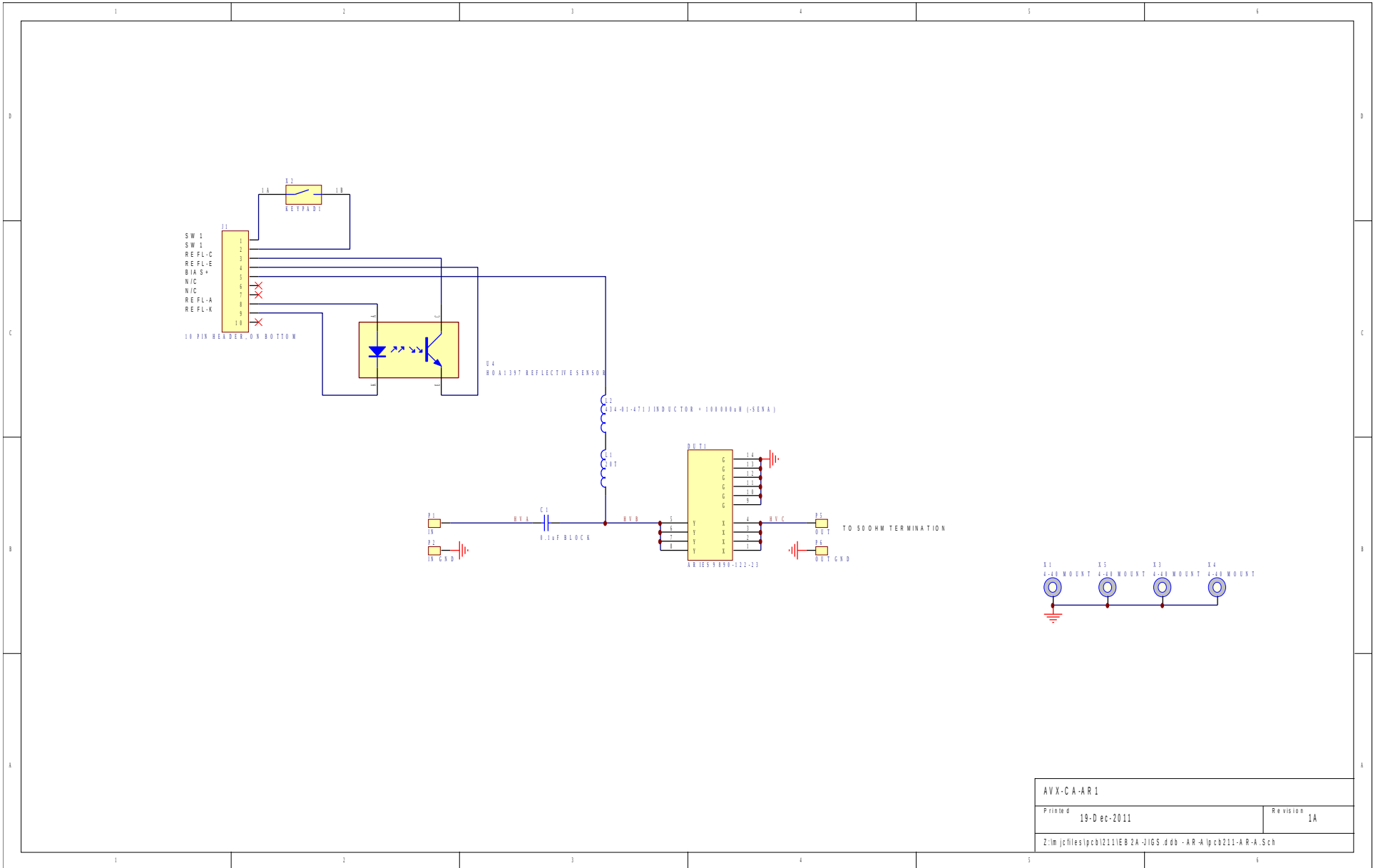

AVX-C-A-AR 1	
Printed 19-Dec-2011	Revision 1A
Z:\m\jcf\files\pcb\1211\EB 2A - JIGS.ddb - AR-A\pcb211-AR-A.Sch	

CUSTOMIZED TEST JIG WIRING (AVX-CA-KMBP-TO39)

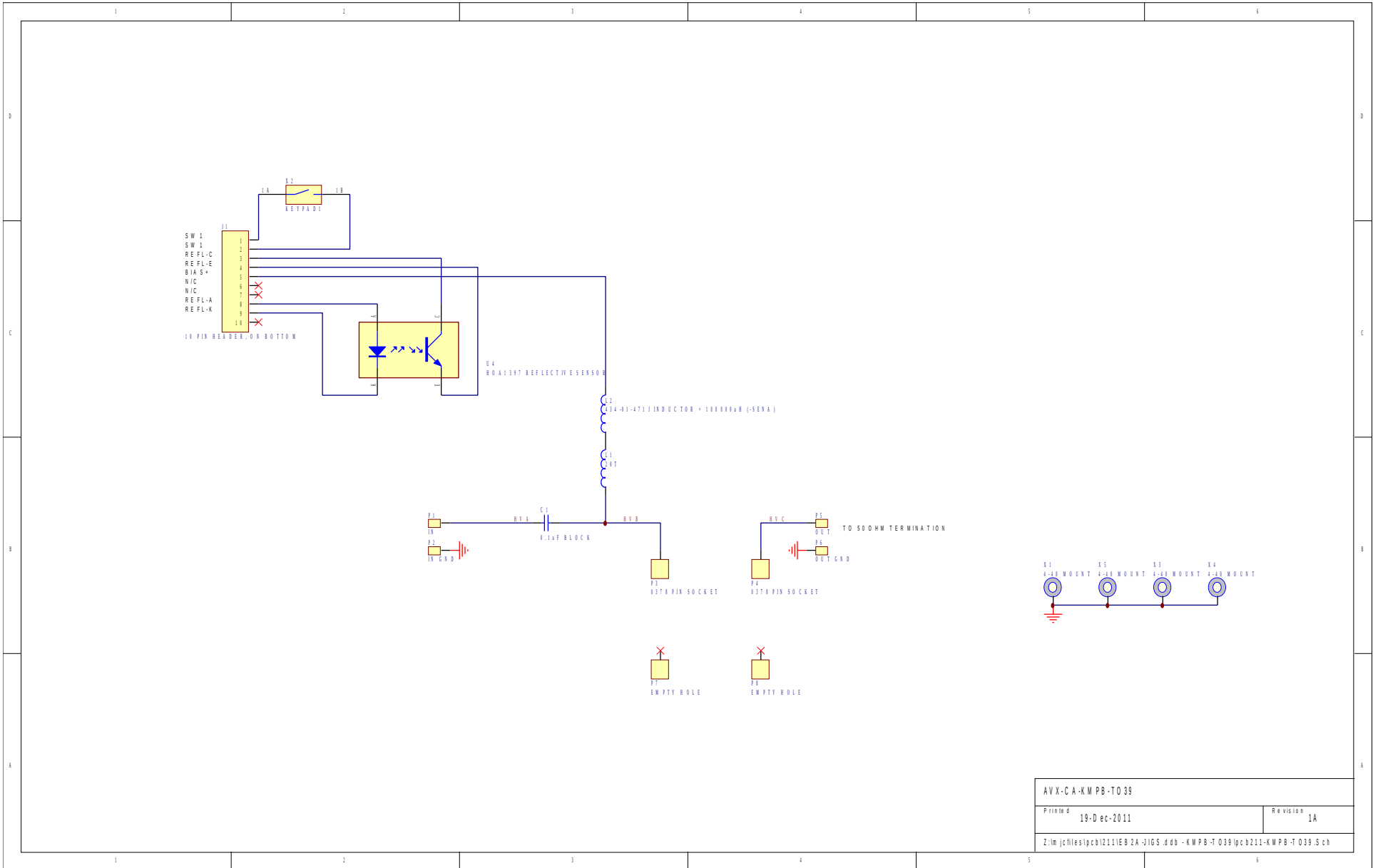

AVX-C A-KM PB -TO 39	
Printed 19-Dec-2011	Revision 1A
Z:\m\jcf\files\pco1211\EB 2A-3JGS.ddb - KWPB-T 039\pco1211-KWPB-T 039.Sch	

PERFORMANCE CHECK SHEET