



# AVTECH ELECTROSYSTEMS LTD.

NANOSECOND WAVEFORM ELECTRONICS  
SINCE 1975

P.O. BOX 265  
OGDENSBURG, NY  
U.S.A. 13669-0265  
TEL: (315) 472-5270  
FAX: (613) 226-2802

TEL: 1-800-265-6681  
FAX: 1-800-561-1970

e-mail: [info@avtechpulse.com](mailto:info@avtechpulse.com)  
<http://www.avtechpulse.com/>

BOX 5120, LCD MERIVALE  
OTTAWA, ONTARIO  
CANADA K2C 3H4  
TEL: (613) 226-5772  
FAX: (613) 226-2802

## INSTRUCTIONS

MODEL AVR-G2-C-P-UGA

0 TO 400 VOLTS, 1 kHz

HIGH SPEED PULSE GENERATOR

WITH 20 ns RISE TIMES

SERIAL NUMBER: \_\_\_\_\_

### WARRANTY

Avtech Electrosystems Ltd. warrants products of its manufacture to be free from defects in material and workmanship under conditions of normal use. If, within one year after delivery to the original owner, and after prepaid return by the original owner, this Avtech product is found to be defective, Avtech shall at its option repair or replace said defective item. This warranty does not apply to units which have been disassembled, modified or subjected to conditions exceeding the applicable specifications or ratings. This warranty is the extent of the obligation assumed by Avtech with respect to this product and no other warranty or guarantee is either expressed or implied.

### TECHNICAL SUPPORT

Phone: 613-226-5772 or 1-800-265-6681

Fax: 613-226-2802 or 1-800-561-1970

E-mail: [info@avtechpulse.com](mailto:info@avtechpulse.com)

World Wide Web: <http://www.avtechpulse.com>

## TABLE OF CONTENTS

<b>WARRANTY.....</b>	<b>2</b>
<b>TECHNICAL SUPPORT.....</b>	<b>2</b>
<b>TABLE OF CONTENTS.....</b>	<b>3</b>
<b>INTRODUCTION.....</b>	<b>4</b>
<b>SPECIFICATIONS.....</b>	<b>5</b>
<b>ORIGINAL QUOTATION.....</b>	<b>6</b>
<b>EC DECLARATION OF CONFORMITY.....</b>	<b>8</b>
<b>INSTALLATION.....</b>	<b>9</b>
<b>VISUAL CHECK.....</b>	<b>9</b>
<b>POWER RATINGS.....</b>	<b>9</b>
<b>CONNECTION TO THE POWER SUPPLY.....</b>	<b>9</b>
<b>ENVIRONMENTAL CONDITIONS.....</b>	<b>9</b>
<b>FUSES.....</b>	<b>10</b>
<b>AC FUSE REPLACEMENT.....</b>	<b>10</b>
<b>DC FUSE REPLACEMENT.....</b>	<b>11</b>
<b>FUSE RATINGS.....</b>	<b>11</b>
<b>FRONT PANEL CONTROLS.....</b>	<b>12</b>
<b>REAR PANEL CONTROLS.....</b>	<b>14</b>
<b>GENERAL INFORMATION.....</b>	<b>15</b>
<b>BASIC TEST ARRANGEMENT.....</b>	<b>15</b>
<b>BASIC PULSE CONTROL.....</b>	<b>15</b>
<b>PREVENTING DAMAGE.....</b>	<b>17</b>
<b>MECHANICAL INFORMATION.....</b>	<b>18</b>
<b>TOP COVER REMOVAL.....</b>	<b>18</b>
<b>ELECTROMAGNETIC INTERFERENCE.....</b>	<b>18</b>
<b>MAINTENANCE.....</b>	<b>19</b>
<b>REGULAR MAINTENANCE.....</b>	<b>19</b>
<b>CLEANING.....</b>	<b>19</b>
<b>PERFORMANCE CHECK SHEET.....</b>	<b>20</b>

## INTRODUCTION

The AVR-G2-C-P-UGA is a high performance instrument capable of generating up to +400V into 100 k $\Omega$  loads at repetition rates up to 1 kHz. The output pulse width is variable from 100 ns to 1 ms. Between pulses, the output voltage is set by the front-panel amplitude control. During the pulse, the output falls to zero. The rise time is fixed at less than 20 ns.

The output is designed to drive loads of 100 k $\Omega$  or higher. Attaching a 50 $\Omega$  load may damage the instrument.

This instrument is intended for use in research and development laboratories.

## SPECIFICATIONS

Model:	AVR-G2-C
Amplitude:	0 to 400 Volts
Pulse width:	100 ns to 1 ms
Load impedance:	$\geq 100 \text{ k}\Omega$
Rise time:	$\leq 20 \text{ ns}$
Fall time:	$\leq 20 \text{ ns}$
PRF:	0 to 1 kHz
Duty cycle:	0 - 50 %
Polarity:	Positive
Propagation delay:	$\leq 100 \text{ ns}$ (Ext trig in to pulse out)
Jitter:	$\pm 100 \text{ ps} \pm 0.03\%$ of sync delay. Ext trig in to pulse out.
Trigger required: (ext trig mode)	Mode A: + 5 Volt, 50 ns - 500 ns (TTL) Mode B: + 5 Volt, $PW_{IN} = PW_{OUT}$ (TTL)
Sync delay:	Variable, 0 to $\pm 1 \text{ ms}$
Sync output:	+ 3 Volts, 200 ns, will drive 50 Ohm loads
Connectors:	Out, Trig, Sync: BNC
Power requirements:	120/240 Volts (switchable) 50 - 60 Hz
Dimensions (H x W x D):	100 mm x 430 mm x 375 mm (3.9" x 17" x 14.8")
Chassis material:	cast aluminum frame and handles, blue vinyl on aluminum cover plates
Mounting:	Any

ORIGINAL QUOTATION

August 16, 2002

To: Richard Walters  
Dept. of Chemistry  
Univ. of Georgia  
706-542-1745  
rwalters@chem.uga.edu

Richard,

Following our telephone conversation, I am pleased to quote as follows:

Quote number: 11165A

Model number: AVR-G2-C-P-UGA

Description: High Voltage Pulser with manual controls

Polarity: positive

Amplitude: 0 to 400V

Other: as per the standard AVR-G2-C-P, see  
<http://www.avtechpulse.com/speed/avr-g2> for details

Price: \$5205 US, FOB destination (includes 5% academic discount).

Delivery: 60-90 days after receipt of order.

We can also provide a computer-controllable version:

Quote number: 11165B

Model number: AVR-G2-B-P-UGA

Description: High Voltage Pulser with IEEE-488.2 GPIB and RS-232 interfaces

Polarity: positive

Amplitude: 0 to 400V

Other: as per the standard AVR-G2-B-P, see  
<http://www.avtechpulse.com/speed/avr-g2> for details

Price: \$7588 US, FOB destination (includes 5% academic discount).

Delivery: 60-90 days after receipt of order.

We can not improve the rise and fall times beyond 20 ns.  
Please call or email me if I can be of further assistance.

Regards,  
Dr. Michael J. Chudobiak  
VP, New Product Development

--- Avtech Electrosystems Ltd. ----- since 1975 ---

PO Box 265	ph: 1-800-265-6681 or 613-226-5772	Box 5120 Stn. F
Ogdensburg, NY	fax: 1-800-561-1970 or 613-226-2802	Ottawa, Ontario
USA 13669-0265	email: <a href="mailto:info@avtechpulse.com">info@avtechpulse.com</a>	Canada K2C 3H4
	<a href="http://www.avtechpulse.com/">http://www.avtechpulse.com/</a>	

Nanosecond Waveform Generators  
for general purpose, R&D and OEM applications

Pulse Generators - Laser Diode Drivers - Pulse Amplifiers  
Impulse Generators - Current Pulsers - Delay Generators - Splitters  
Function Generators - Monocycle Generators - Frequency Dividers + more!  
-----

EC DECLARATION OF CONFORMITY

We

Avtech Electrosystems Ltd.  
P.O. Box 5120, LCD Merivale  
Ottawa, Ontario  
Canada K2C 3H4

declare that this pulse generator meets the intent of Directive 89/336/EEC for Electromagnetic Compatibility. Compliance pertains to the following specifications as listed in the official Journal of the European Communities:

EN 50081-1 Emission

EN 50082-1 Immunity

and that this pulse generator meets the intent of the Low Voltage Directive 72/23/EEC as amended by 93/68/EEC. Compliance pertains to the following specifications as listed in the official Journal of the European Communities:

EN 61010-1:2001 Safety requirements for electrical equipment for measurement, control, and laboratory use





## INSTALLATION

### VISUAL CHECK

After unpacking the instrument mainframe and the transformer module, examine to ensure that they have not been damaged in shipment. Visually inspect all connectors, knobs, and handles. Confirm that a power cord and an instrumentation manual (this manual), are with the instrument. If the instrument has been damaged, file a claim immediately with the company that transported the instrument.

### POWER RATINGS

This instrument is intended to operate from 115 / 230 V  $\pm$  10%, 50-60 Hz. The instrument automatically switches between these two levels. Note, however, that different fuses are required for the two ranges, as described in the "FUSES" section.

The maximum power consumption is 57 Watts. This instrument is an "Installation Category II" instrument, intended for operation from a normal single-phase supply.

### CONNECTION TO THE POWER SUPPLY

An IEC-320 three-pronged recessed male socket is provided on the back panel for AC power connection to the instrument. One end of the detachable power cord that is supplied with the instrument plugs into this socket. The other end of the detachable power cord plugs into the local mains supply. Use only the cable supplied with the instrument. The mains supply must be earthed, and the cable used to connect the instrument to the mains supply must provide an earth connection. (The supplied cable does this.)

### ENVIRONMENTAL CONDITIONS

This instrument is intended for use under the following conditions:

- a) indoor use;
- b) altitude up to 2 000 m;
- c) temperature 5 °C to 40 °C;
- d) maximum relative humidity 80 % for temperatures up to 31 °C decreasing linearly to 50 % relative humidity at 40 °C;
- e) Mains supply voltage fluctuations up to  $\pm$ 10 % of the nominal voltage;
- f) no pollution or only dry, non-conductive pollution.

## FUSES

This instrument contains four fuses. All are accessible from the rear-panel. Two protect the AC prime power input, and two protect the internal DC power supplies. The locations of the fuses on the rear panel are shown in the figure below:

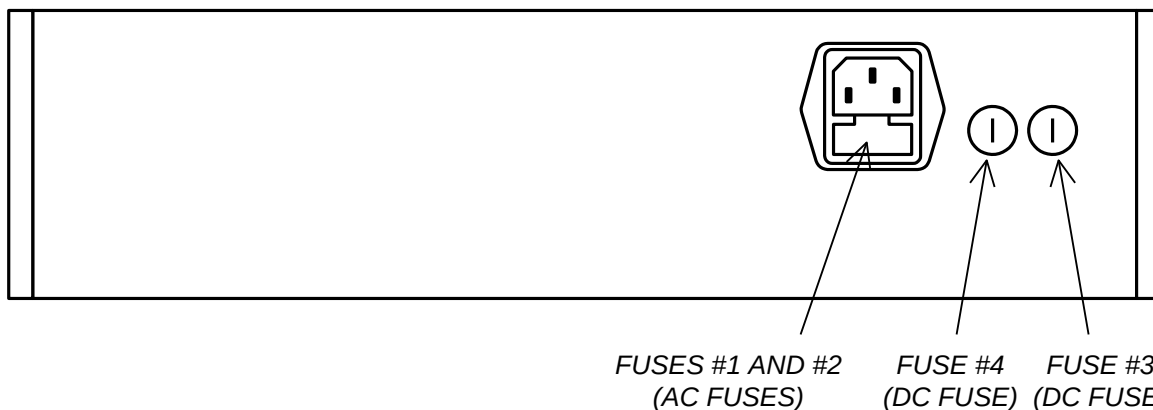

### AC FUSE REPLACEMENT

To physically access the AC fuses, the power cord must be detached from the rear panel of the instrument. The fuse drawer may then be extracted using a small flat-head screwdriver, as shown below:

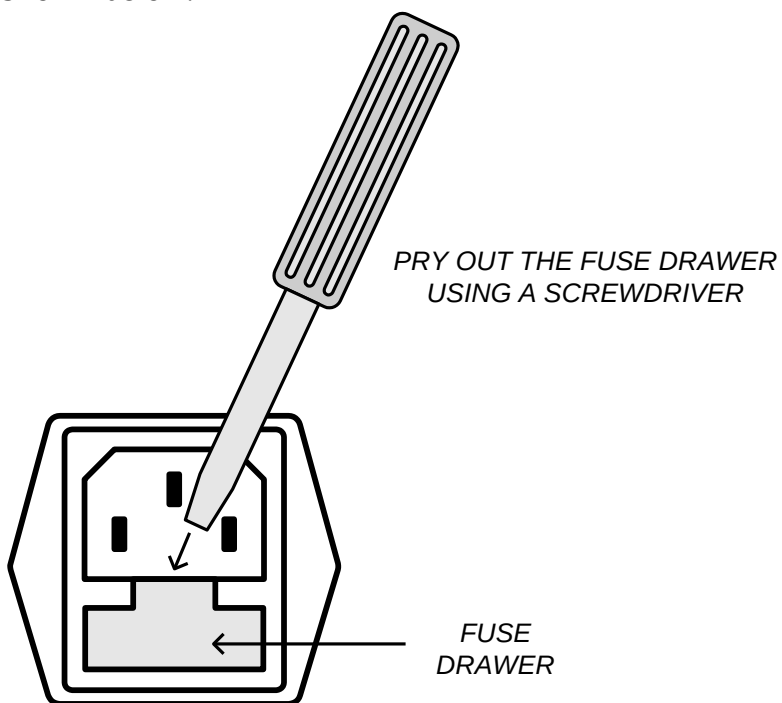

## DC FUSE REPLACEMENT

The DC fuses may be replaced by inserting the tip of a flat-head screwdriver into the fuse holder slot, and rotating the slot counter-clockwise. The fuse and its carrier will then pop out.

## FUSE RATINGS

The following table lists the required fuses:

Fuses	Mains Voltage	Rating	Case Size	Manufacturer's Part Number (Wickmann)	Distributor's Part Number (Digi-Key)
#1, #2 (AC)	115 V	0.5A, 250V, Time-Delay	5 x 20 mm	1950500000	WK5041-ND
	230 V	0.25A, 250V, Time-Delay	5 x 20 mm	1950250000	WK5035-ND
#3 (DC)	115/230V	0.8A, 250V, Time-Delay	5 x 20 mm	1950800000	WK5046-ND
#4 (DC)	115/230V	0.5A, 250V, Time-Delay	5 x 20 mm	1950500000	WK5041-ND

The fuse manufacturer is Wickmann (<http://www.wickmann.com/>).

Replacement fuses may be easily obtained from Digi-Key (<http://www.digikey.com/>) and other distributors.

## FRONT PANEL CONTROLS

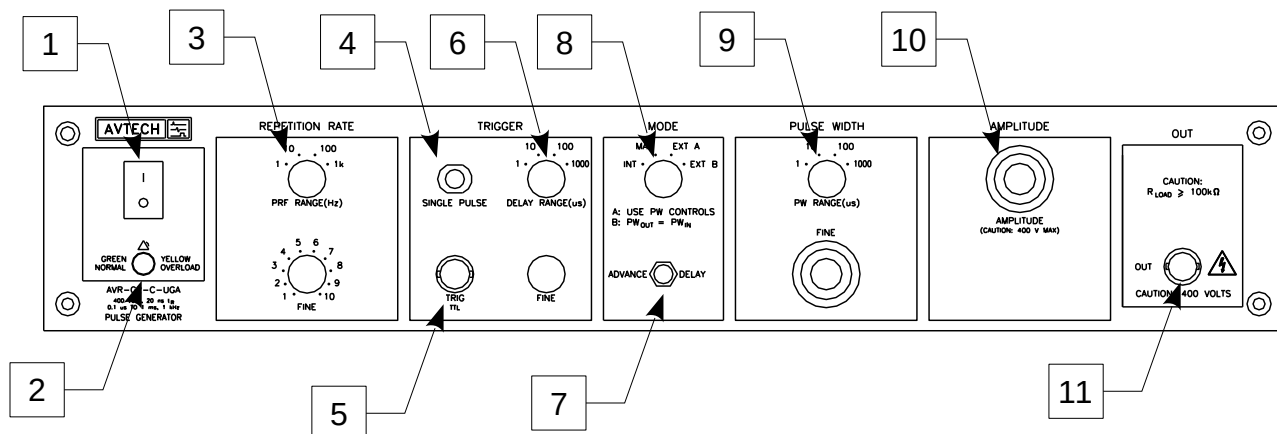

1. POWER Switch. This is the main power switch. When turning the instrument on, there may be a delay of several seconds before the instrument appears to respond.
2. OVERLOAD Indicator. When the instrument is powered, this indicator is normally green, indicating normal operation. If this indicator is yellow, an internal automatic overload protection circuit has been tripped. If the unit is overloaded (by operating at an exceedingly high duty cycle or by operating into a very low impedance), the protective circuit will disable the output of the instrument and turn the indicator light yellow. The light will stay yellow (i.e. output disabled) for about 5 seconds after which the instrument will attempt to re-enable the output (i.e. light green) for about 1 second. If the overload condition persists, the output will be disabled again (i.e. light yellow) for another 5 seconds. If the overload condition has been removed, the instrument will resume normal operation.

This overload indicator may flash yellow briefly at start-up. This is not a cause for concern.

3. PRF Range Switch and Vernier. This switch sets the pulse repetition frequency (PRF) range of the internal oscillator. The marked value of each position is the upper limit of the range, approximately. The vernier dial directly below the switch varies the PRF within the set range.
4. SINGLE PULSE Push Button. The "SINGLE PULSE" push button will trigger the instrument manually for one cycle of output, when the "MODE" switch is in the "MAN" position. Otherwise, the push button has no effect.
5. TRIG Connector. When the "MODE" switch is in the "EXT" position, this connector is an input. The external trigger (50 ns or wider, TTL levels) is applied to this connector.

When operating in the "INT" mode, this connector is an output. A SYNC output is generated on this connector, to synchronize oscilloscopes or other measurement

systems.

6. Delay Range Switch and Vernier. This switch and one-turn dial sets the delay between the main output and the TRIG output. The marked value of each switch position is the upper limit of the range, approximately. The vernier dial directly below the switch varies the delay within the set range.
7. ADVANCE/DELAY Switch. With this switch in the DELAY position, the leading edge of the output pulse precedes the leading edge of the TRIG output. When in the ADVANCE position, the leading edge of the TRIG output precedes the leading edge of the main output.
8. MODE Switch. In the "INT" position the instrument is internally triggered and the TRIG connector provides a SYNC output which allows one to trigger other instruments, such as oscilloscopes.

In the "MAN" position a single pulse can be generated by pressing the "SINGLE PULSE" push button. The TRIG connector is not used in this mode.

In the "EXT A" position the instrument is triggered by a TTL-level pulse on the TRIG connector. The output parameters (pulse width, delay, and amplitude) are determined by the front panel settings.

In the "EXT B" position the instrument is triggered by a TTL-level pulse on the TRIG connector. The output pulse occurs with nominally zero delay, and the output pulse width is approximately equal to the input pulse width. The amplitude is controlled by the front panel settings.

9. Pulse Width Range Switch and Vernier. This switch and ten-turn dial set the pulse width of the the main output. The marked value of each switch position is the upper limit of the range, approximately. The vernier dial directly below the switch varies the delay within the set range.
10. AMPLITUDE Controls. This ten-turn dial provides continuously variable control of the peak amplitude of the main output from 0 to the full-scale range value.
11. OUT CONNECTOR. This BNC connector provides the main output signal, into load impedances of 100 k $\Omega$  or higher.

 Caution: Voltages as high as 400V may be present on the center conductor of this output connector. Avoid touching this conductor. Connect to this connector using standard coaxial cable, to ensure that the center conductor is not exposed.

## REAR PANEL CONTROLS

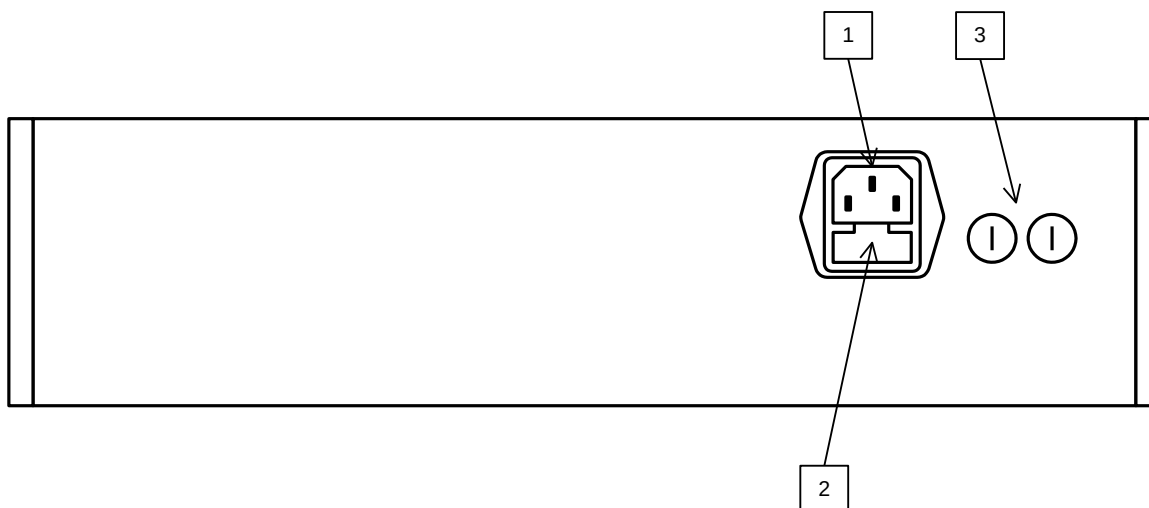

1. AC POWER INPUT. An IEC-320 C14 three-pronged recessed male socket is provided on the back panel for AC power connection to the instrument. One end of the detachable power cord that is supplied with the instrument plugs into this socket.
2. AC FUSE DRAWER. The two fuses that protect the AC input are located in this drawer. Please see the “FUSES” section of this manual for more information.
3. DC FUSES. These two fuses protect the internal DC power supplies. Please see the “FUSES” sections of this manual for more information.

## GENERAL INFORMATION

### BASIC TEST ARRANGEMENT

The AVR-G2-C-P-UGA should be tested with an oscilloscope with a bandwidth of at least 100 MHz to properly observe the high-speed waveform. A typical test arrangement is shown below:

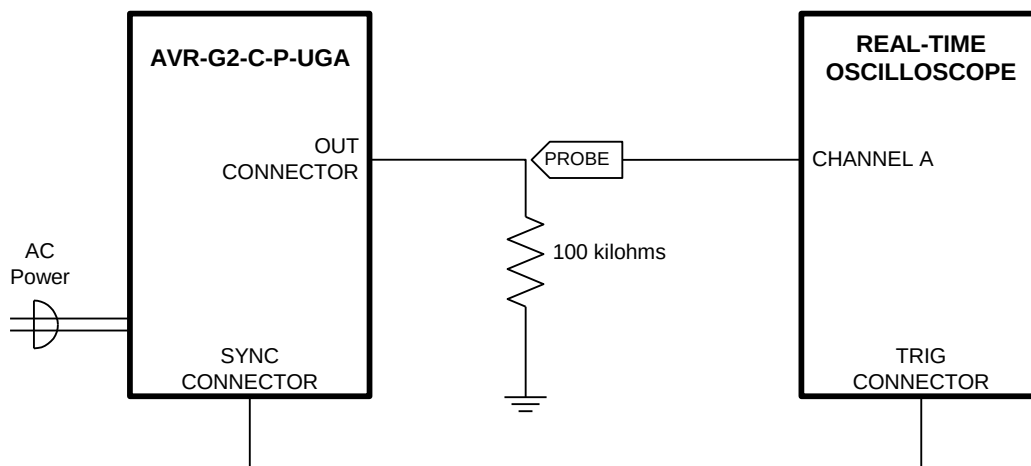

### BASIC PULSE CONTROL

This instrument can be triggered by its own internal clock or by an external TTL trigger signal. When triggered internally, two mainframe output channels respond to the trigger: OUT and SYNC.

- OUT. This is the main output.
- TRIG. The TRIG pulse is a fixed-width TTL-level reference pulse used to trigger oscilloscopes or other measurement systems.

When the ADVANCE/DELAY switch is set to "ADVANCE", the TRIG output precedes the main output. These pulses are illustrated below:

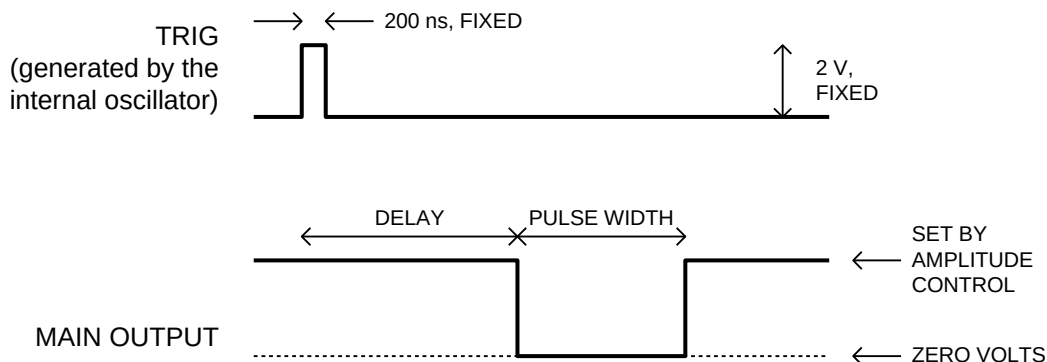

When the ADVANCE/DELAY switch is set to "DELAY", the TRIG output occurs after the main output. This illustrated below:

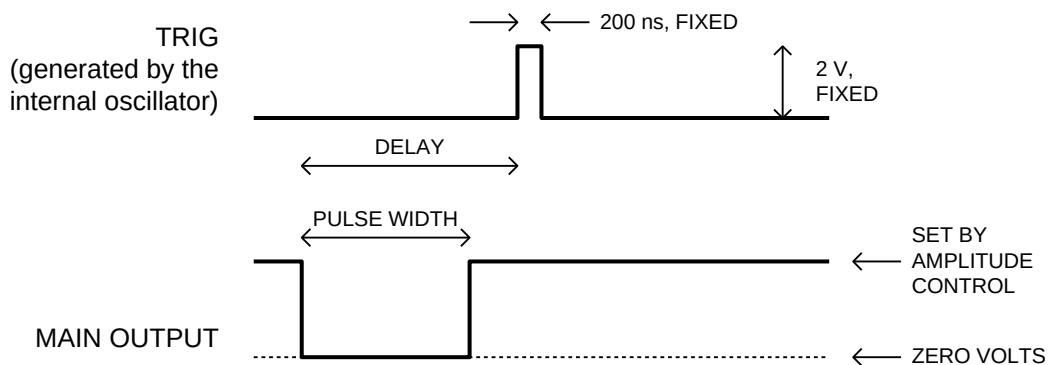

When triggered externally, the TRIG connector acts as an input. This illustrated below:

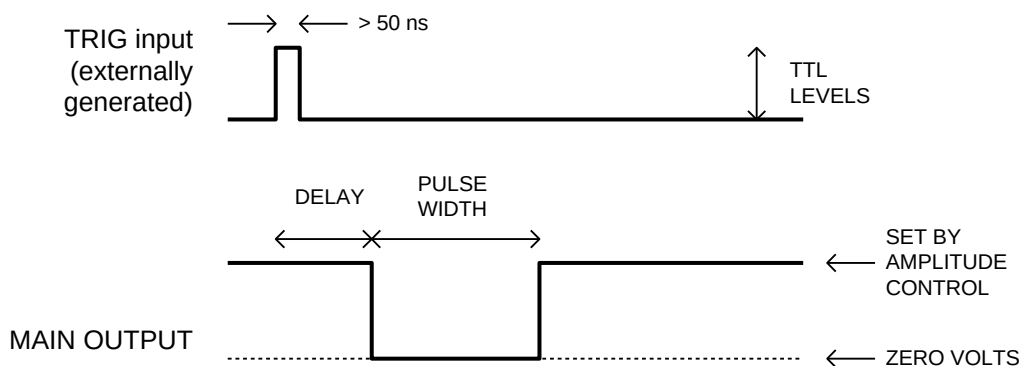



## PREVENTING DAMAGE

The AVR-G2-C-P-UGA may fail if triggered at a PRF greater than 1 kHz.

This unit is designed to operate into a load impedance of 100 k $\Omega$  or higher. The output may be damaged if load impedances lower than 100 k $\Omega$  are used. Never use a 50 Ohm load.

The lifetime of the switching elements in the pulse generator module is proportional to the running time of the instrument. For this reason the prime power to the instrument should be turned off when the instrument is not in use.

## MECHANICAL INFORMATION

### TOP COVER REMOVAL

If necessary, the interior of the instrument may be accessed by removing the four Phillips screws on the top panel. With the four screws removed, the top cover may be slid back (and off).

Always disconnect the power cord before opening the instrument.

There are no user-adjustable internal circuits. For repairs other than fuse replacement, please contact Avtech (info@avtechpulse.com) to arrange for the instrument to be returned to the factory for repair.

⚠ Caution: High voltages are present inside the instrument during normal operation. Do not operate the instrument with the cover removed.

### ELECTROMAGNETIC INTERFERENCE

To prevent electromagnetic interference with other equipment, all used outputs should be connected to shielded 50Ω loads using shielded 50Ω coaxial cables. Unused outputs should be terminated with shielded 50Ω BNC terminators or with shielded BNC dust caps, to prevent unintentional electromagnetic radiation. All cords and cables should be less than 3m in length.

## MAINTENANCE

### REGULAR MAINTENANCE

This instrument does not require any regular maintenance.

On occasion, one or more of the four rear-panel fuses may require replacement. All fuses can be accessed from the rear panel. See the “FUSES” section for details.

### CLEANING

If desired, the interior of the instrument may be cleaned using compressed air to dislodge any accumulated dust. (See the “TOP COVER REMOVAL” section for instructions on accessing the interior.) No other cleaning is recommended.

PERFORMANCE CHECK SHEET