



AVTECH ELECTROSYSTEMS LTD.

NANOSECOND WAVEFORM ELECTRONICS
SINCE 1975

P.O. BOX 265
OGDENSBURG, NY
U.S.A. 13669-0265
TEL: (315) 472-5270
FAX: (613) 226-2802

TEL: 1-800-265-6681
FAX: 1-800-561-1970

e-mail: info@avtechpulse.com
<http://www.avtechpulse.com/>

BOX 5120, LCD MERIVALE
OTTAWA, ONTARIO
CANADA K2C 3H4
TEL: (613) 226-5772
FAX: (613) 226-2802

INSTRUCTIONS

MODEL AVR-G5-C-UCRA

DUAL-CHANNEL (0 TO $\pm 200V$ & 0 TO +200V)

HIGH SPEED PULSE GENERATOR

WITH 20 ns RISE TIMES

SERIAL NUMBER: _____

WARRANTY

Avtech Electrosystems Ltd. warrants products of its manufacture to be free from defects in material and workmanship under conditions of normal use. If, within one year after delivery to the original owner, and after prepaid return by the original owner, this Avtech product is found to be defective, Avtech shall at its option repair or replace said defective item. This warranty does not apply to units which have been disassembled, modified or subjected to conditions exceeding the applicable specifications or ratings. This warranty is the extent of the obligation assumed by Avtech with respect to this product and no other warranty or guarantee is either expressed or implied.

TECHNICAL SUPPORT

Phone: 613-226-5772 or 1-800-265-6681

Fax: 613-226-2802 or 1-800-561-1970

E-mail: info@avtechpulse.com

World Wide Web: <http://www.avtechpulse.com>

TABLE OF CONTENTS

WARRANTY.....	2
TECHNICAL SUPPORT.....	2
TABLE OF CONTENTS.....	3
INTRODUCTION.....	4
HIGH-VOLTAGE PRECAUTIONS.....	5
ORIGINAL QUOTATION.....	6
EC DECLARATION OF CONFORMITY.....	8
INSTALLATION.....	9
VISUAL CHECK.....	9
POWER RATINGS.....	9
CONNECTION TO THE POWER SUPPLY.....	9
ENVIRONMENTAL CONDITIONS.....	9
FUSES.....	10
AC FUSE REPLACEMENT.....	10
DC FUSE REPLACEMENT.....	11
FUSE RATINGS.....	11
FRONT PANEL CONTROLS.....	12
REAR PANEL CONTROLS.....	14
GENERAL INFORMATION.....	15
BASIC TEST ARRANGEMENT.....	15
BASIC PULSE CONTROL.....	15
CABLING CONSIDERATIONS.....	16
PREVENTING DAMAGE.....	17
MECHANICAL INFORMATION.....	18
TOP COVER REMOVAL.....	18
ELECTROMAGNETIC INTERFERENCE.....	18
MAINTENANCE.....	19
REGULAR MAINTENANCE.....	19
CLEANING.....	19
PERFORMANCE CHECK SHEET.....	20

INTRODUCTION

The AVR-G5-C-UCRA is a high performance instrument capable of generating up to 200V into 100 k Ω loads at repetition rates up to 100 kHz. Two main outputs are provided - one is bipolar, and one is unipolar.

The bipolar output swings between a negative voltage and a nominally equal positive voltage. The rising edge of this output leads the rising edge of the unipolar output by a phase shift of 90 degrees.

The unipolar output swings between zero and a positive voltage. The rising edge of this output lags the rising edge of the bipolar output by a phase shift of 90 degrees. The peak-to-peak amplitude of the unipolar output is nominally half that of the bipolar output.

Both outputs are 50% duty cycle square waves and both outputs have an output impedance (i.e., an internal resistance in series with the output) of 50 Ohms, to provide transmission line back-matching and short-circuit protection. These resistors are accessible if the top cover is removed, and they can be replaced by the user with higher resistance resistors if desired.

The rise and fall times are fixed at less than 20 ns. However, the output impedance is 50 Ω , so the rise and fall times will degrade if cable lengths longer than 1 meter (3 feet) are used on the output, due to the cable capacitance.

The output is designed to drive loads of 100 k Ω or higher. Attaching a 50 Ω load may damage the instrument.

This instrument is intended for use in research and development laboratories.

HIGH-VOLTAGE PRECAUTIONS

 **CAUTION:** This instrument provides output voltages as high as ± 200 Volts, so extreme caution must be employed when using this instrument. The instrument should only be used by individuals who are thoroughly skilled in high voltage laboratory techniques. The following precaution should always be observed:

1. Keep exposed high-voltage wiring to an absolute minimum.
2. Wherever possible, use shielded connectors and cabling.
3. Connect and disconnect loads and cables only when the amplifier is turned off.
4. Keep in mind that all cables, connectors, oscilloscope probes, and loads must have an appropriate voltage rating.
5. Do not attempt any repairs on the instrument, beyond the fuse replacement procedures described in this manual. Contact Avtech technical support (see page 2 for contact information) if the instrument requires servicing.

ORIGINAL QUOTATION

Date: Wed, 05 May 2004 10:14:51 -0400
From: Avtech Sales
To: "Jory A. Yarmoff"
Subject: Re: Avtech pulse generator quote

May 5, 2004
To: Jory Yarmoff
Dept. of Physics
University of California, Riverside
ph. (909) 787-5336
fax (909) 787-4529
yarmoff@ucr.edu

Jory,

Following your recent inquiry, I am pleased to quote as follows:

Quote number: 12065

Model number: AVR-G5-C-UCRA

Description: High-Voltage Dual-Channel Pulser

Outputs: Two main outputs - one bipolar, one unipolar

Triggering: Internal trigger only. 10 Hz to 100 kHz, adjustable. The two outputs share a common trigger.

Amplitude control: A single ten-turn amplitude control dial is shared by the two outputs. As the dial is rotated from minimum to maximum, the bipolar output will increase from 0 to 400 Volts peak-to-peak, and the unipolar output amplitude will increase from 0 to +200 Volts.

Bipolar output: This output swings between a negative voltage and a nominally equal positive voltage. The rising edge of this output leads the rising edge of the unipolar output by a phase shift of 90 degrees.

Unipolar output: This output swings between zero and a positive voltage. The rising edge of this output lags the rising edge of the bipolar output by a phase shift of 90 degrees. The peak-to-peak amplitude of the unipolar output is nominally half that of the bipolar output.

Duty cycle: Fixed at 50% for both outputs.

Rise and fall times (20%-80%): < 20 ns for both outputs.

Load impedance: > 100 kilohms for both outputs.

Output impedance (i.e., in series with the output): 50 Ohms for both outputs. This provides transmission-line backmatching. These resistors are accessible if the top cover is removed, and they can be replaced by the user with higher resistance resistors if desired.

Sync output: +3V, 200 ns, will drive 50 Ohms.

Sync delay: The sync output may be delayed by 0 to 100 us relative to the rising edge of the bipolar output.

Power requirements: 100-240 Volts, 50-60 Hz.

Chassis dimensions: 100 mm x 430 mm x 375 mm (3.9" x 17" x 14.8")

Price: \$7998 US each, FOB destination (includes 5% academic discount).

Estimated delivery: 60 days after receipt of order.

I have quoted on the least costly approach, by fixing the phase shift between the two outputs, by fixing the duty cycle at 50%, by sharing a common amplitude control, and by omitting any variable series resistance (for rise time control).

Please call or email me if I can be of further assistance.

Regards,
Dr. Michael J. Chudobiak
Chief Engineer

--- Avtech Electrosystems Ltd. ----- since 1975 ---

PO Box 265	ph: 1-800-265-6681 or 613-226-5772	Box 5120,
Ogdensburg,	fax: 1-800-561-1970 or 613-226-2802	LCD Merivale
New York	email: info@avtechpulse.com	Ottawa, Ontario
USA 13669-0265	http://www.avtechpulse.com/	Canada K2C 3H4

Nanosecond Waveform Generators
for general purpose, R&D and OEM applications

Pulse Generators - Laser Diode Drivers - Pulse Amplifiers
Impulse Generators - Current Pulsers - Delay Generators - Splitters
Function Generators - Monocycle Generators - Frequency Dividers + more!

EC DECLARATION OF CONFORMITY

We

Avtech Electrosystems Ltd.
P.O. Box 5120, LCD Merivale
Ottawa, Ontario
Canada K2C 3H4

declare that this pulse generator meets the intent of Directive 89/336/EEC for Electromagnetic Compatibility. Compliance pertains to the following specifications as listed in the official Journal of the European Communities:

EN 50081-1 Emission

EN 50082-1 Immunity

and that this pulse generator meets the intent of the Low Voltage Directive 72/23/EEC as amended by 93/68/EEC. Compliance pertains to the following specifications as listed in the official Journal of the European Communities:

EN 61010-1:2001 Safety requirements for electrical equipment for measurement, control, and laboratory use



INSTALLATION

VISUAL CHECK

After unpacking the instrument mainframe and the transformer module, examine to ensure that they have not been damaged in shipment. Visually inspect all connectors, knobs, and handles. Confirm that a power cord and an instrumentation manual (this manual), are with the instrument. If the instrument has been damaged, file a claim immediately with the company that transported the instrument.

POWER RATINGS

This instrument is intended to operate from 100 - 240 V, 50 - 60 Hz.

The maximum power consumption is 57 Watts. Please see the "FUSES" section for information about the appropriate AC and DC fuses.

This instrument is an "Installation Category II" instrument, intended for operation from a normal single-phase supply.

CONNECTION TO THE POWER SUPPLY

An IEC-320 three-pronged recessed male socket is provided on the back panel for AC power connection to the instrument. One end of the detachable power cord that is supplied with the instrument plugs into this socket. The other end of the detachable power cord plugs into the local mains supply. Use only the cable supplied with the instrument. The mains supply must be earthed, and the cable used to connect the instrument to the mains supply must provide an earth connection. (The supplied cable does this.)

ENVIRONMENTAL CONDITIONS

This instrument is intended for use under the following conditions:

- a) indoor use;
- b) altitude up to 2 000 m;
- c) temperature 5 °C to 40 °C;
- d) maximum relative humidity 80 % for temperatures up to 31 °C decreasing linearly to 50 % relative humidity at 40 °C;
- e) Mains supply voltage fluctuations up to ± 10 % of the nominal voltage;
- f) no pollution or only dry, non-conductive pollution.

FUSES

This instrument contains four fuses. All are accessible from the rear-panel. Two protect the AC prime power input, and two protect the internal DC power supplies. The locations of the fuses on the rear panel are shown in the figure below:

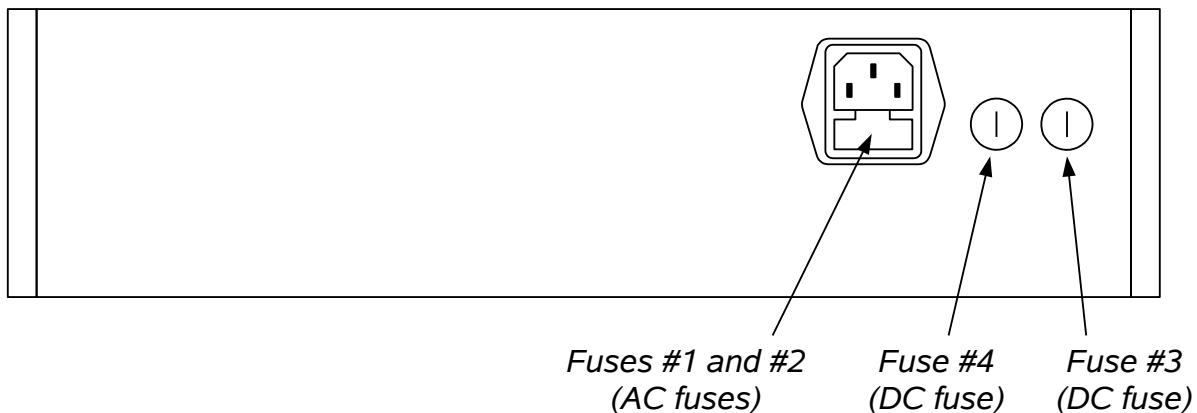

AC FUSE REPLACEMENT

To physically access the AC fuses, the power cord must be detached from the rear panel of the instrument. The fuse drawer may then be extracted using a small flat-head screwdriver, as shown below:

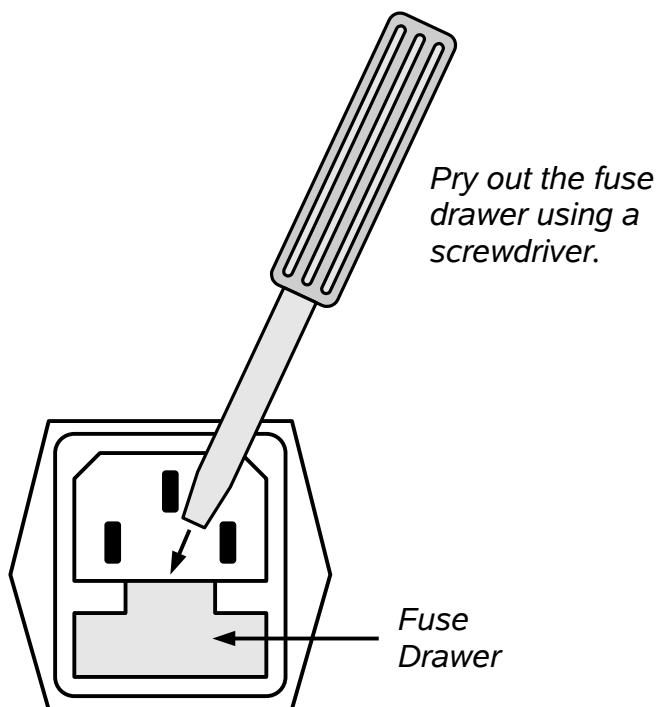

DC FUSE REPLACEMENT

The DC fuses may be replaced by inserting the tip of a flat-head screwdriver into the fuse holder slot, and rotating the slot counter-clockwise. The fuse and its carrier will then pop out.

FUSE RATINGS

The following table lists the required fuses:

Fuses	Nominal Mains Voltage	Rating	Case Size	Manufacturer's Part Number (Wickmann)	Distributor's Part Number (Digi-Key)
#1, #2 (AC)	100-240V	0.5A, 250V, Time-Delay	5×20 mm	1950500000	WK5041-ND
#3 (DC)	N/A	1.6A, 250V, Time-Delay	5×20 mm	1951160000	WK5053-ND
#4 (DC)	N/A	0.8A, 250V, Time-Delay	5×20 mm	1950800000	WK5046-ND

The fuse manufacturer is Wickmann (<http://www.wickmann.com/>).

Replacement fuses may be easily obtained from Digi-Key (<http://www.digikey.com/>) and other distributors.

FRONT PANEL CONTROLS

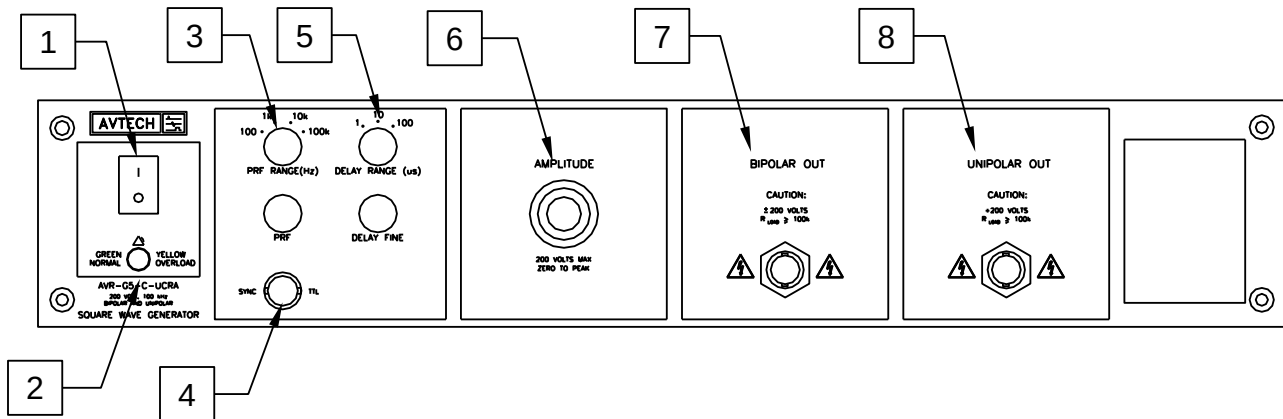

1. POWER Switch. This is the main power switch. When turning the instrument on, there may be a delay of several seconds before the instrument appears to respond.
2. OVERLOAD Indicator. When the instrument is powered, this indicator is normally green, indicating normal operation. If this indicator is yellow, an internal automatic overload protection circuit has been tripped. If the unit is overloaded (by operating at an exceedingly high duty cycle or by operating into a very low impedance), the protective circuit will disable the output of the instrument and turn the indicator light yellow. The light will stay yellow (i.e. output disabled) for about 5 seconds after which the instrument will attempt to re-enable the output (i.e. light green) for about 1 second. If the overload condition persists, the output will be disabled again (i.e. light yellow) for another 5 seconds. If the overload condition has been removed, the instrument will resume normal operation.

This overload indicator may flash yellow briefly at start-up. This is not a cause for concern.
3. PRF Range Switch and Vernier. This switch sets the pulse repetition frequency (PRF) range of the internal oscillator. The marked value of each position is the upper limit of the range, approximately. The vernier dial directly below the switch varies the PRF within the set range.
4. SYNC Connector. A SYNC output is generated on this connector, to synchronize oscilloscopes or other measurement systems. The sync output may be delayed by 0 to 100 us relative to the rising edge of the bipolar output, using the delay controls.
5. Delay Range Switch and Vernier. This switch and one-turn dial sets the delay between the rising edge of the bipolar output and the SYNC output. The marked value of each switch position is the upper limit of the range, approximately. The vernier dial directly below the switch varies the delay within the set range.

6. AMPLITUDE Controls. This ten-turn amplitude control dial is shared by the two outputs. As the dial is rotated from minimum to maximum, the bipolar output will increase from 0 to 400 Volts peak-to-peak, and the unipolar output amplitude will increase from 0 to +200 Volts.
7. BIPOLAR OUT Connector. This BNC connector provides the bipolar output signal, into load impedances of 100 k Ω or higher.

 Caution: Voltages as high as $\pm 200\text{V}$ may be present on the center conductor of this output connector. Avoid touching this conductor. Connect to this connector using standard coaxial cable, to ensure that the center conductor is not exposed.

8. UNIPOLAR OUT Connector. This BNC connector provides the unipolar output signal, into load impedances of 100 k Ω or higher.

 Caution: Voltages as high as +200V may be present on the center conductor of this output connector. Avoid touching this conductor. Connect to this connector using standard coaxial cable, to ensure that the center conductor is not exposed.

REAR PANEL CONTROLS

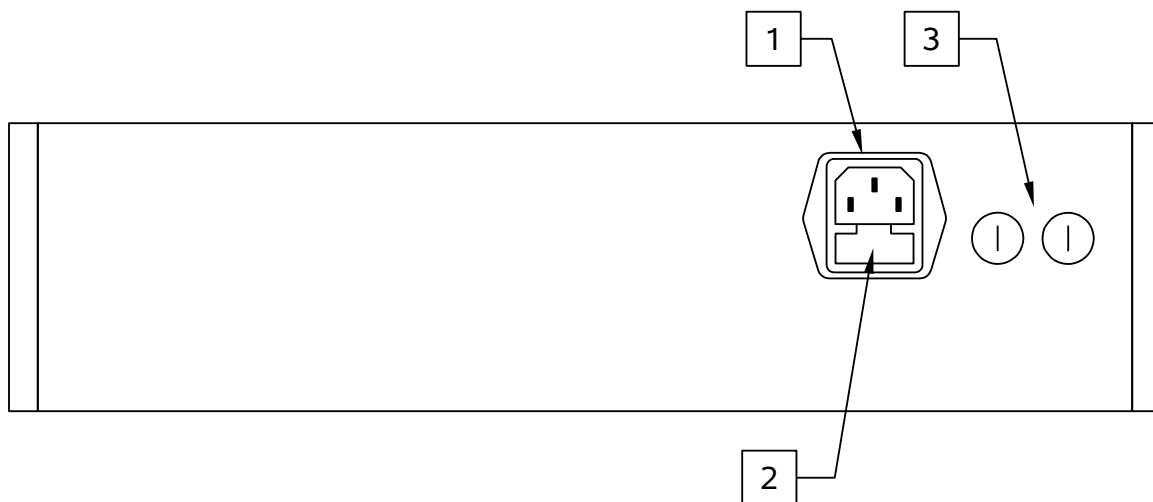

1. AC POWER INPUT. An IEC-320 C14 three-pronged recessed male socket is provided on the back panel for AC power connection to the instrument. One end of the detachable power cord that is supplied with the instrument plugs into this socket.
2. AC FUSE DRAWER. The two fuses that protect the AC input are located in this drawer. Please see the “FUSES” section of this manual for more information.
3. DC FUSES. These two fuses protect the internal DC power supplies. Please see the “FUSES” sections of this manual for more information.

GENERAL INFORMATION

BASIC TEST ARRANGEMENT

The AVR-G5-C-UCRA should be tested with an oscilloscope with a bandwidth of at least 100 MHz to properly observe the high-speed waveform. A typical test arrangement is shown below:

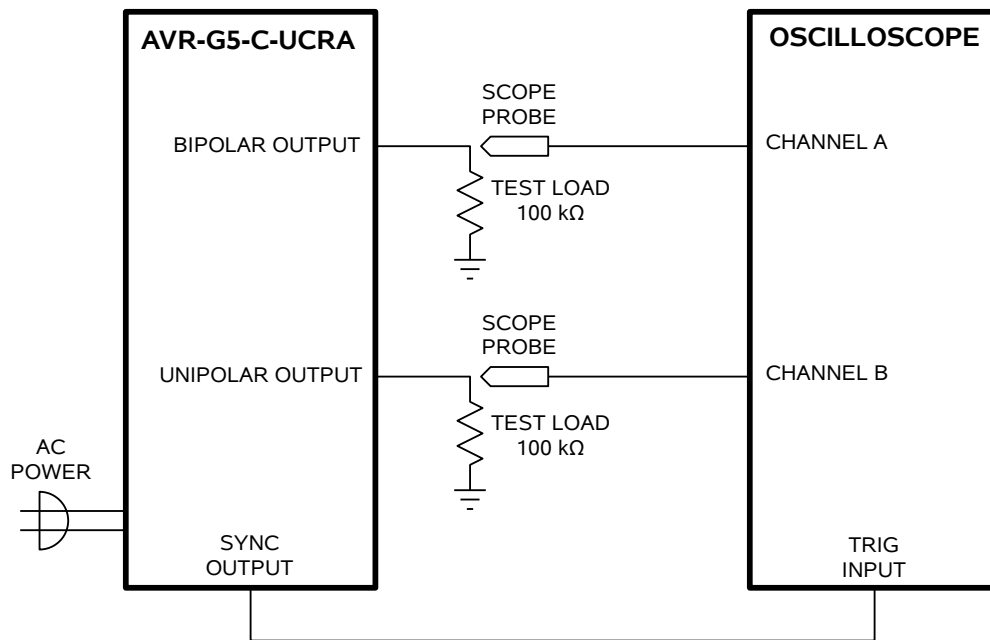

BASIC PULSE CONTROL

This instrument can be triggered by its own internal clock or by an external TTL trigger signal. When triggered internally, three mainframe output channels respond to the trigger: BIPOLAR OUT, UNIPOLAR OUT, and SYNC.

- BIPOLAR OUT. This output swings between a negative voltage and a nominally equal positive voltage. The rising edge of this output leads the rising edge of the unipolar output by a phase shift of 90 degrees.
- UNIPOLAR OUT. This output swings between zero and a positive voltage. The rising edge of this output lags the rising edge of the bipolar output by a phase shift of 90 degrees. The peak-to-peak amplitude of the unipolar output is nominally half that of the bipolar output.
- SYNC. The SYNC pulse is a fixed-width TTL-level reference pulse used to trigger oscilloscopes or other measurement systems. The sync output may be delayed by 0 to 100 us relative to the rising edge of the bipolar output.

These pulses are illustrated below:

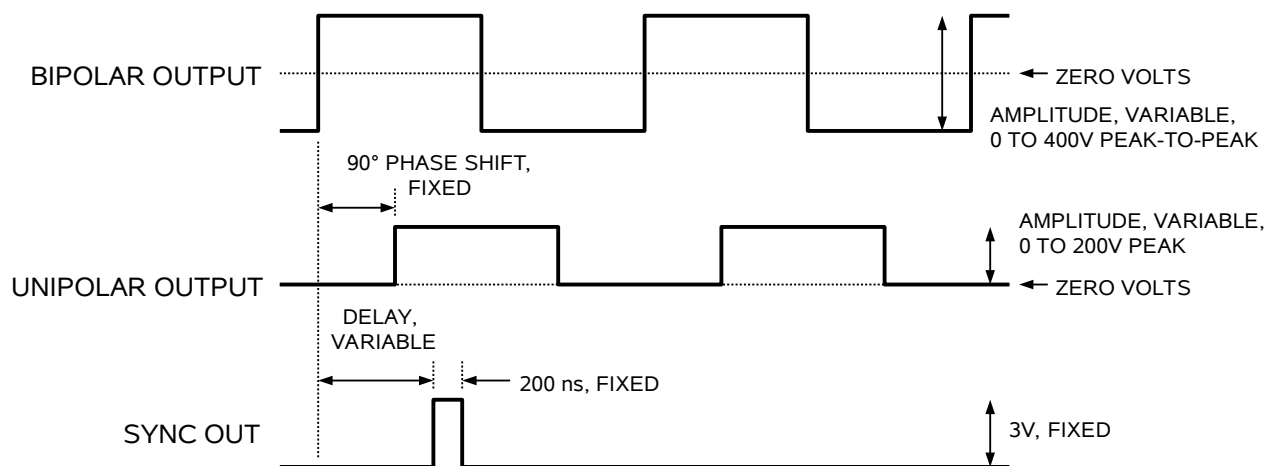

CABLING CONSIDERATIONS

The rise and fall times are fixed at less than 20 ns. However, the output impedance is 50Ω, so the rise and fall times will degrade if cable lengths longer than 1 meter (3 feet) are used on the output, due to the cable capacitance.

The output is designed to drive loads of 100 kΩ or higher. Attaching a 50Ω load may damage the instrument.

PREVENTING DAMAGE

The AVR-G5-C-UCRA may fail if triggered at a PRF greater than 100 kHz.

This unit is designed to operate into a load impedance of 100 k Ω or higher. The output may be damaged if load impedances lower than 100 k Ω are used. Never use a 50 Ohm load.

The lifetime of the switching elements in the pulse generator module is proportional to the running time of the instrument. For this reason the prime power to the instrument should be turned off when the instrument is not in use.

MECHANICAL INFORMATION

TOP COVER REMOVAL

If necessary, the interior of the instrument may be accessed by removing the four Phillips screws on the top panel. With the four screws removed, the top cover may be slid back (and off).

Always disconnect the power cord before opening the instrument.

There are no user-adjustable internal circuits. For repairs other than fuse replacement, please contact Avtech (info@avtechpulse.com) to arrange for the instrument to be returned to the factory for repair.

 Caution: High voltages are present inside the instrument during normal operation. Do not operate the instrument with the cover removed.

ELECTROMAGNETIC INTERFERENCE

To prevent electromagnetic interference with other equipment, all used outputs should be connected to shielded loads using shielded coaxial cables. Unused outputs should be terminated with shielded coaxial terminators or with shielded coaxial dust caps, to prevent unintentional electromagnetic radiation. All cords and cables should be less than 3m in length.

MAINTENANCE

REGULAR MAINTENANCE

This instrument does not require any regular maintenance.

On occasion, one or more of the four rear-panel fuses may require replacement. All fuses can be accessed from the rear panel. See the “FUSES” section for details.

CLEANING

If desired, the interior of the instrument may be cleaned using compressed air to dislodge any accumulated dust. (See the “TOP COVER REMOVAL” section for instructions on accessing the interior.) No other cleaning is recommended.

PERFORMANCE CHECK SHEET