



AVTECH ELECTROSYSTEMS LTD.

NANOSECOND WAVEFORM ELECTRONICS
SINCE 1975

P.O. BOX 265
OGDENSBURG, NY
U.S.A. 13669-0265

TEL: 888-670-8729 (USA & Canada) or +1-613-686-6675 (Intl)
FAX: 800-561-1970 (USA & Canada) or +1-613-686-6679 (Intl)

info@avtechpulse.com - <http://www.avtechpulse.com/>

BOX 5120, LCD MERIVALE
OTTAWA, ONTARIO
CANADA K2C 3H5

INSTRUCTIONS

MODEL AVRQ-5-B

± 1.5 kV PULSE GENERATOR

WITH dV/dt RATES

EXCEEDING 120 kV/us

FOR COMMON MODE TRANSIENT IMMUNITY (CMTI) TESTS

SERIAL NUMBER: _____

WARRANTY

Avtech Electrosystems Ltd. warrants products of its manufacture to be free from defects in material and workmanship under conditions of normal use. If, within one year after delivery to the original owner, and after prepaid return by the original owner, this Avtech product is found to be defective, Avtech shall at its option repair or replace said defective item. This warranty does not apply to units which have been disassembled, modified or subjected to conditions exceeding the applicable specifications or ratings. This warranty is the extent of the obligation assumed by Avtech with respect to this product and no other warranty or guarantee is either expressed or implied.

TECHNICAL SUPPORT

Phone: 888-670-8729 (USA & Canada) or +1-613-686-6675 (International)

Fax: 800-561-1970 (USA & Canada) or +1-613-686-6679 (International)

E-mail: info@avtechpulse.com

World Wide Web: <http://www.avtechpulse.com>

TABLE OF CONTENTS

WARRANTY	2
TECHNICAL SUPPORT	2
TABLE OF CONTENTS	3
INTRODUCTION	6
HIGH-VOLTAGE PRECAUTIONS	8
SPECIFICATIONS	9
REGULATORY NOTES	11
FCC PART 18.....	11
EC DECLARATION OF CONFORMITY.....	11
DIRECTIVE 2011/65/EU (RoHS).....	12
DIRECTIVE 2002/96/EC (WEEE).....	12
FIRMWARE LICENSING.....	13
INSTALLATION	14
VISUAL CHECK.....	14
POWER RATINGS.....	14
CONNECTION TO THE POWER SUPPLY.....	14
PROTECTION FROM ELECTRIC SHOCK.....	15
ENVIRONMENTAL CONDITIONS.....	16
FUSES	17
AC FUSE REPLACEMENT.....	17
DC FUSE REPLACEMENT.....	18
FUSE RATINGS.....	18
CHASSIS CONFIGURATIONS	19
STANDARD CONFIGURATION.....	19
-FPD CONFIGURATION.....	19
FRONT PANEL CONTROLS (UNITS WITHOUT -FPD OPTION)	20
REAR PANEL CONTROLS (UNITS WITHOUT -FPD OPTION)	22
FRONT PANEL CONTROLS (UNITS WITH -FPD OPTION)	25
REAR PANEL CONTROLS (UNITS WITH -FPD OPTION)	28
GENERAL INFORMATION	30
BASIC PULSE CONTROL.....	30
TRIGGER MODES.....	31
GATING MODES.....	32

<i>DUT INSTALLATION</i>	33
SOCKET PINOUT.....	33
DAUGHTERBOARD PINOUT.....	34
DAUGHTERBOARD COMPONENTS.....	37
CUSTOM DAUGHTERBOARDS.....	39
DIFFERENTIAL PROBING.....	39
INSTALLING THE DAUGHTERBOARDS.....	40
<i>BASIC TEST ARRANGEMENTS</i>	41
INTER-CHANNEL INTERFERENCE.....	43
<i>TYPICAL WAVEFORMS FOR STANDARD DAUGHTERBOARDS</i>	44
BASIC THEORY.....	44
CONTROLLING THE TRANSITION TIME.....	45
TYPICAL POSITIVE RESULTS, WITH NO DUT INSTALLED.....	46
TYPICAL NEGATIVE RESULTS, WITH NO DUT INSTALLED.....	47
VO3120 RESULTS.....	48
HCPL-7721 RESULTS.....	51
<i>TYPICAL WAVEFORMS FOR CUSTOMIZED DAUGHTERBOARDS</i>	54
PCB 298B (FOR TLP2366).....	54
PCB 299B (FOR ADUM241E0BRWZ).....	58
<i>CAPACITIVE INTERFERENCE ISSUES</i>	62
<i>INDUCTIVE SPIKES AND PROBE SATURATION</i>	67
<i>DC CORRECTNESS ISSUES</i>	69
<i>VERIFICATION AND TROUBLESHOOTING</i>	70
<i>SAFETY CONCERNS</i>	72
TURN OUTPUT OFF BEFORE ACCESSING DUT.....	72
AUTOMATIC TIMEOUT.....	72
OVERLOAD INDICATOR.....	72
<i>OPERATIONAL CHECK</i>	73
<i>PROTECTING YOUR INSTRUMENT</i>	75
USE HIGH-VOLTAGE CABLES, CONNECTORS, AND PROBES.....	75
SHORT-CIRCUIT PROTECTION.....	75
<i>MECHANICAL INFORMATION</i>	76
TOP COVER REMOVAL.....	76
RACK MOUNTING.....	76

- MAINTENANCE..... 77**
 - REGULAR MAINTENANCE..... 77
 - CLEANING..... 77
 - TRIGGER DAMAGE..... 77
- PROGRAMMING YOUR PULSE GENERATOR..... 78**
 - KEY PROGRAMMING COMMANDS..... 78
 - ALL PROGRAMMING COMMANDS..... 79
- WIRING DIAGRAMS..... 81**
 - WIRING OF AC POWER..... 81
 - WIRING OF +54VDC POWER RAIL..... 82
 - PCB 158Q - LOW VOLTAGE POWER SUPPLY, 1/3..... 83
 - PCB 158Q - LOW VOLTAGE POWER SUPPLY, 2/3..... 84
 - PCB 158Q - LOW VOLTAGE POWER SUPPLY, 3/3..... 85
 - PCB 104F - KEYPAD / DISPLAY BOARD, 1/3..... 86
 - PCB 104F - KEYPAD / DISPLAY BOARD, 2/3..... 87
 - PCB 104F - KEYPAD / DISPLAY BOARD, 3/3..... 88
 - DUT WIRING, ON MAIN PCB..... 89
 - DUT WIRING, ON STANDARD DAUGHTERBOARD (PCB 267C)..... 90
 - DUT WIRING, ON CUSTOMIZED TLP2366 DAUGHTERBOARD (PCB 298B)..... 91
 - DUT WIRING, ON CUSTOMIZED ADUM241E0BRWZ DAUGHTERBOARD (PCB 299B) . 92
 - MAIN WIRING..... 93
- PERFORMANCE CHECK SHEET..... 94**

INTRODUCTION

The AVRQ-5-B is designed to test the common mode transient immunity (CMTI) of optocouplers.

The standard AVRQ-5-B can generate -1.5 or +1.5 kV pulses. The unloaded switching time (10%-90%) is fixed at ≤ 10 ns. The transition time may be increased to at least 50 ns by adding high-voltage capacitors across the device under test (by soldering it to the DUT daughterboard). This corresponds to transition rates of < 24 to > 120 kV/us.

The -AHV option provides greater flexibility in the amplitude setting, permitting adjustment from 1.0 to 1.5 kV (+ or -) in ≤ 1 V steps.

The -XHV option provides a different amplitude range of 1.5 to 2.0 kV (+ or -) in ≤ 1 V steps, but the minimum switching time increases to 15 ns.

A daughterboard arrangement is used to accommodate difference device packages and bias conditions. A zero-insertion force (ZIF) socket accepts these daughterboards. Eight daughterboards suitable for use with typical 5V DIP8 packages are included with the AVRQ-5-B. The CAD/CAM files for these sample boards are available for download at https://www.avtechpulse.com/semiconductor/avrq-5/#support_files. Users may design their own daughterboards to accommodate other package styles.

The AVRQ-5-B mainframe provides the high-voltage common mode pulse (which is tied to GND1), and VCC2 / GND2 (the non-floating output-side power supply). The user is responsible for configuring the daughterboards to implement the correct input side power (VCC1), biasing, filtering, loading, socketing, and glitch measurement. The included sample boards implement these requirements for common DIP8 devices, using configurable jumpers/resistors/capacitors. A probe point is provided on the main circuit board for observation of the device logic output with a user-provided probe and oscilloscope.

The ground-referenced output-side power (VCC2) is generated by the mainframe, and is adjustable (+3V to +43V, 150 mA maximum). The floating input-side power is not provided by the mainframe. Instead, an A23-type 12V battery should be installed on the DUT daughterboard to provide a floating power source, along with a basic regulator circuit to provide the necessary regulated +5V power (VCC1). A isolated battery arrangement is used to ensure that the VCC1 power supply is not the source of any glitches observed in the operation of the DUT.

The high-voltage pulse and the logic output of the DUT must be measured by the user, using suitable high-impedance oscilloscope probes. Coaxial cabling should not be used, because it will introduce too much parasitic capacitance.

The AVRQ-5-B features front panel keyboard and adjust knob control of the output pulse parameters along with a four line by 40-character backlit LCD display of the rise time, pulse width, pulse delay, and pulse repetition frequency. The instrument includes

memory to store up to four complete instrument setups. The operator may use the front panel or the computer interface to store a complete “snapshot” of all key instrument settings, and recall this setup at a later time.

This instrument is intended for use in research, development, test and calibration laboratories by qualified personnel.

HIGH-VOLTAGE PRECAUTIONS

 **CAUTION:** This instrument provides output voltages as high as 1500 or 2000 Volts under normal operating conditions, so extreme caution must be employed when using this instrument. The instrument should only be used by individuals who are thoroughly skilled in high voltage laboratory techniques. The following precautions should always be observed:

1. Keep exposed high-voltage wiring to an absolute minimum.
2. Wherever possible, use shielded connectors and cabling.
3. Connect and disconnect loads and cables only when the instrument is turned off.
4. Keep in mind that all cables, connectors, oscilloscope probes, and loads must have an appropriate voltage rating.

Do not attempt any repairs on the instrument, beyond the fuse replacement procedures described in this manual. Contact Avtech technical support (see page 2 for contact information) if the instrument requires servicing.

SPECIFICATIONS

Model:	AVRQ-5-B ¹
High-Voltage Pulse Amplitude: (HV pulse / GND1)	Standard: -1.5 or +1.5 kV -AHV ⁹ option: -1 kV to -1.5 kV, +1 kV to +1.5 kV, in $\leq 1V$ steps -XHV ¹⁰ option: -1.5 kV to -2 kV, -1.5 kV to -2 kV, in $\leq 1V$ steps
Load resistance:	> 10 Megohms (this is not a 50 Ohm system.)
Load capacitance (C_{LOAD}):	0 to ~300 pF. Must be adjusted to obtain the desired transition time.
Load connection style:	A pattern of pin sockets into which a daughterboard may be plugged is provided. Sample daughterboards with 8-pin DIP sockets are included. The user may also use their own custom-made daughterboards.
Leading edge rise time ² : (10% - 90%):	≤ 10 ns (≤ 15 ns with -XHV option ¹⁰) for $C_{LOAD} = 0$. Up to 50 ns, by increasing C_{LOAD} .
Leading edge shape:	Approximately linear. See the typical waveform photos on the preceding and following pages.
Trailing edge fall time ³ (90%-10%):	At least ten times greater than the leading edge rise time. Not adjustable.
Trailing edge shape:	Exponential decay, approximately. See the typical waveform photos in this manual.
Pulse width (measured between the start of the leading edge and the start of the falling edge):	1 - 20 μ s, adjustable.
PRF:	10 Hz maximum
VCC1 power supply (input side, floating, referenced to HV pulse / GND1):	Not provided by the mainframe. The input side of the daughterboards must be self-powered. The included sample boards use an A23-type battery with a low-dropout regulator.
VCC2 power supply (output side, referenced to GND2 chassis ground):	+3V to +43V, adjustable. 150 mA maximum.
Logic output pull-up resistance:	User-installed, on daughterboard as appropriate
Output connector, HV PULSE:	BNC female, suitable for use with the Tektronix P5100 high-voltage probe and 013-0291-00 probe-tip-to-BNC adapter
Output connector, logic output:	A two-pin header suitable for use with the Tektronix P6246 differential probe ⁸ . Other probes may be used by installing a matching two-pin socket as an extender.
Output enable timer:	The output will only remain active for 90 seconds after the last output parameter update. After that time, the output will be disabled. The output must be re-enabled from the front panel or by computer command for the next test sequence.
Propagation delay:	≤ 200 ns (Ext trig in to start of output pulse)
Jitter (Ext trig in to pulse out):	± 200 ps $\pm 0.03\%$ of sync delay
Trigger modes:	Internal trigger, external trigger (TTL level pulse, > 10 ns, 1 k Ω input impedance), front-panel "Single Pulse" pushbutton, or single pulse trigger via computer command.
Variable delay:	Sync to Out: 0 to 1.0 seconds, for all trigger modes (including external trigger).
Sync output:	+3 Volts, 100 ns, will drive 50 Ohm loads
Gate input:	Synchronous, active high or low, switchable. Suppresses triggering when active.
Other connectors:	Trig, Sync, Gate: BNC
GPIO and RS-232 control:	Yes. (Visit http://www.avtechpulse.com/labview for LabView drivers.)
Ethernet port, for remote control using VXI-11.3, ssh, telnet, & web:	Optional ⁴ . Recommended as a modern alternative to GPIO / RS-232. See http://www.avtechpulse.com/options/vxi for details.
Settings accuracy:	Not calibrated. Verify the output parameters with a calibrated oscilloscope.
Power requirements:	100 - 240 Volts, 50 - 60 Hz
Dimensions: (H x W x D)	145 x 430 x 475 mm (5.7" x 17" x 18.8")
Chassis material:	cast aluminum frame and handles, blue vinyl on aluminum cover plates
Temperature range:	+5°C to +40°C

- 1) -B suffix indicates IEEE-488.2 GPIO and RS-232 control of amplitude, pulse width, PRF and delay (See <http://www.avtechpulse.com/gpib/>).
- 2) The rise time is affected by the load capacitance. A high-voltage high-bandwidth oscilloscope probe such as the Tektronix P5100 should always be used to verify the actual output rise time, rather than relying on the programmed value.
- 3) Refers to the trailing edge, which swings from -1000V or -2000V to 0V
- 4) Add the suffix -VXI to the model number to specify the Ethernet port.
- 5) Note that coaxial cabling typically adds 30 pF/ft.
- 6) The user must install a standard 9V battery in the provided holder, in order to power the floating power supply. The battery is not included, due to shipping regulations.
- 7) To specify the extended VCC2 range, add the -SCHB option suffix to the model number.
- 8) A differential probe is suggested to reduce the possibility of interference from the high-voltage pulse. Note that the P6246 is only suitable for values of VCC2 up to +7V. A non-differential probe may be more suitable if VCC2 > 7V, or if parasitic inductances or capacitances in the test circuit cause differential voltage spikes exceeding $\pm 7V$. The P6246 can saturate under those conditions, which can generate apparent glitch-like transients that are not due to the DUT. Some experimentation may be required by the user in order to identify the best probing arrangement.
- 9) Add the suffix -AHV to the model number to specify the +/- 1 to 1.5 kV (in $\leq 1V$ steps) operating range.
- 10) Add the suffix -XHV to the model number to specify the +/- 1.5 to 2 kV (in $\leq 1V$ steps) operating range. This option increases the minimum switching time by 5 ns.

REGULATORY NOTES

FCC PART 18

This device complies with part 18 of the FCC rules for non-consumer industrial, scientific and medical (ISM) equipment.

This instrument is enclosed in a rugged metal chassis and uses a filtered power entry module (where applicable). The main output signal is provided on a shielded connector that is intended to be used with shielded coaxial cabling and a shielded load. Under these conditions, the interference potential of this instrument is low.

If interference is observed, check that appropriate well-shielded cabling is used on the output connectors. Contact Avtech (info@avtechpulse.com) for advice if you are unsure of the most appropriate cabling. Also, check that your load is adequately shielded. It may be necessary to enclose the load in a metal enclosure.

If any of the connectors on the instrument are unused, they should be covered with shielded metal "dust caps" to reduce the interference potential.

This instrument does not normally require regular maintenance to minimize interference potential. However, if loose hardware or connectors are noted, they should be tightened. Contact Avtech (info@avtechpulse.com) if you require assistance.

EC DECLARATION OF CONFORMITY



We Avtech Electrosystems Ltd.
 P.O. Box 5120, LCD Merivale
 Ottawa, Ontario
 Canada K2C 3H5

declare that this pulse generator meets the intent of Directive 2004/108/EG for Electromagnetic Compatibility. Compliance pertains to the following specifications as listed in the official Journal of the European Communities:

EN 50081-1 Emission

EN 50082-1 Immunity

and that this pulse generator meets the intent of the Low Voltage Directive 2006/95/EC. Compliance pertains to the following specifications as listed in the official Journal of the European Communities:

EN 61010-1:2001 Safety requirements for electrical equipment for measurement, control, and laboratory use

DIRECTIVE 2011/65/EU (RoHS)

We Avtech Electrosystems Ltd.
P.O. Box 5120, LCD Merivale
Ottawa, Ontario
Canada K2C 3H5

declare that, to the best of our knowledge, all electrical and electronic equipment (EEE) sold by the company are in compliance with Directive 2011/65/EU of the European Parliament and of the Council of 8 June 2011 on the restriction of the use of certain hazardous substances in electrical and electronic equipment (also known as “RoHS Recast”). In addition, this declaration of conformity is issued under the sole responsibility of Avtech Electrosystems Ltd. Specifically, products manufactured do not contain the substances listed in the table below in concentrations greater than the listed maximum value.

<i>Material/Substance</i>	<i>Threshold level</i>
Lead (Pb)	< 1000 ppm (0.1% by mass)
Mercury (Hg)	< 1000 ppm (0.1% by mass)
Hexavalent Chromium (Cr6+)	< 1000 ppm (0.1% by mass)
Polybrominated Biphenyls (PBB)	< 1000 ppm (0.1% by mass)
Polybrominated Diphenyl ethers (PBDE)	< 1000 ppm (0.1% by mass)
Cadmium (Cd)	< 100 ppm (0.01% by mass)

DIRECTIVE 2002/96/EC (WEEE)

European customers who have purchased this equipment directly from Avtech will have completed a “WEEE Responsibility Agreement” form, accepting responsibility for WEEE compliance (as mandated in Directive 2002/96/EC of the European Union and local laws) on behalf of the customer, as provided for under Article 9 of Directive 2002/96/EC.

Customers who have purchased Avtech equipment through local representatives should consult with the representative to determine who has responsibility for WEEE

compliance. Normally, such responsibilities will lie with the representative, unless other arrangements (under Article 9) have been made.

Requirements for WEEE compliance may include registration of products with local governments, reporting of recycling activities to local governments, and financing of recycling activities.

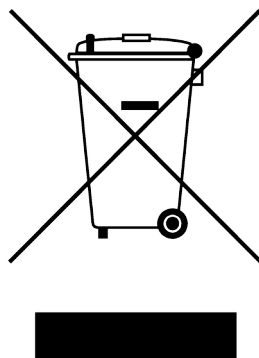

FIRMWARE LICENSING

Instruments with firmware versions 5.00 or higher use open-source software internally. Some of this software requires that the source code be made available to the user as a condition of its licensing. This source code is available upon request (contact info@avtechpulse.com).

Earlier firmware versions do not contain any open source software.

INSTALLATION

VISUAL CHECK

After unpacking the instrument, examine to ensure that it has not been damaged in shipment. Visually inspect all connectors, knobs, liquid crystal displays (LCDs), and the handles. Confirm that a power cord, a GPIB cable, and two instrumentation manuals (this manual and the “Programming Manual for -B Instruments”) are with the instrument. If the instrument has been damaged, file a claim immediately with the company that transported the instrument.

The following additional items should be with the instrument:

1. Eight assembled PCB 267C daughterboards
2. Eight A23-type 12V batteries

POWER RATINGS

This instrument is intended to operate from 100 - 240 V, 50 - 60 Hz.

The maximum power consumption is 57 Watts. Please see the “FUSES” section for information about the appropriate AC and DC fuses.

This instrument is an “Installation Category II” instrument, intended for operation from a normal single-phase supply.

CONNECTION TO THE POWER SUPPLY

An IEC-320 three-pronged recessed male socket is provided on the back panel for AC power connection to the instrument. One end of the detachable power cord that is supplied with the instrument plugs into this socket. The other end of the detachable power cord plugs into the local mains supply. Use only the cable supplied with the instrument. The mains supply must be earthed, and the cord used to connect the instrument to the mains supply must provide an earth connection. (The supplied cord does this.)

 Warning: Failure to use a grounded outlet may result in injury or death due to electric shock. This product uses a power cord with a ground connection. It must be connected to a properly grounded outlet. The instrument chassis is connected to the ground wire in the power cord.

The table below describes the power cord that is normally supplied with this instrument, depending on the destination region:

Destination Region	Description	Option	Manufacturer	Part Number
United Kingdom, Hong Kong, Singapore, Malaysia	BS 1363, 230V, 50 Hz	-AC00	Qualtek	370001-E01
Australia, New Zealand	AS 3112:2000, 230-240V, 50 Hz	-AC01	Qualtek	374003-A01
Continental Europe, Korea, Indonesia, Russia	European CEE 7/7 "Schuko" 230V, 50 Hz	-AC02	Qualtek	364002-D01
North America, Taiwan	NEMA 5-15, 120V, 60 Hz	-AC03	Qualtek	312007-01
Switzerland	SEV 1011, 230V, 50 Hz	-AC06	Qualtek	378001-E01
South Africa, India	SABS 164-1, 220-250V, 50 Hz	-AC17	Volex	2131H 10 C3
Japan	JIS 8303, 100V, 50-60 Hz	-AC18	Qualtek	397002-01
Israel	SI 32, 220V, 50 Hz	-AC19	Qualtek	398001-01
China	GB 1002-1, 220V, 50 Hz	-AC22	Volex	2137H 10 C3

PROTECTION FROM ELECTRIC SHOCK

 Operators of this instrument must be protected from electric shock at all times. The owner must ensure that operators are prevented access and/or are insulated from every connection point. In some cases, connections must be exposed to potential human contact. Operators must be trained to protect themselves from the risk of electric shock. This instrument is intended for use by qualified personnel who recognize shock hazards and are familiar with safety precautions required to avoid possibly injury. In particular, operators should:

1. Keep exposed high-voltage wiring to an absolute minimum.
2. Wherever possible, use shielded connectors and cabling.
3. Connect and disconnect loads and cables only when the instrument is turned off.
4. Keep in mind that all cables, connectors, oscilloscope probes, and loads must have an appropriate voltage rating.
5. Do not attempt any repairs on the instrument, beyond the fuse replacement procedures described in this manual. Contact Avtech technical support (see page 2 for contact information) if the instrument requires servicing. Service is to be performed solely by qualified service personnel.

ENVIRONMENTAL CONDITIONS

This instrument is intended for use under the following conditions:

1. indoor use;
2. altitude up to 2 000 m;
3. temperature 5 °C to 40 °C;
4. maximum relative humidity 80 % for temperatures up to 31 °C decreasing linearly to 50 % relative humidity at 40 °C;
5. Mains supply voltage fluctuations up to ± 10 % of the nominal voltage;
6. no pollution or only dry, non-conductive pollution.

FUSES

This instrument contains four fuses. All are accessible from the rear-panel. Two protect the AC prime power input, and two protect the internal DC power supplies. The locations of the fuses on the rear panel are shown in the figure below:

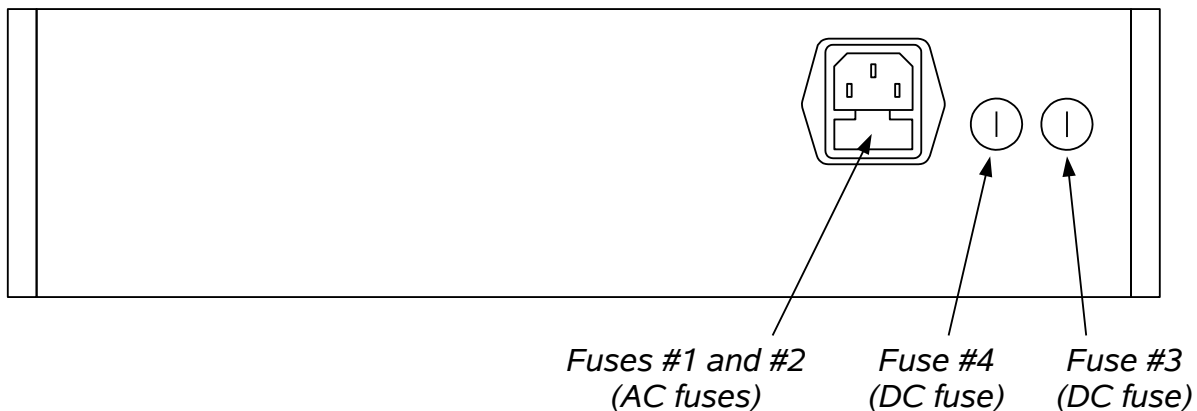

AC FUSE REPLACEMENT

To physically access the AC fuses, the power cord must be detached from the rear panel of the instrument. The fuse drawer may then be extracted using a small flat-head screwdriver, as shown below:

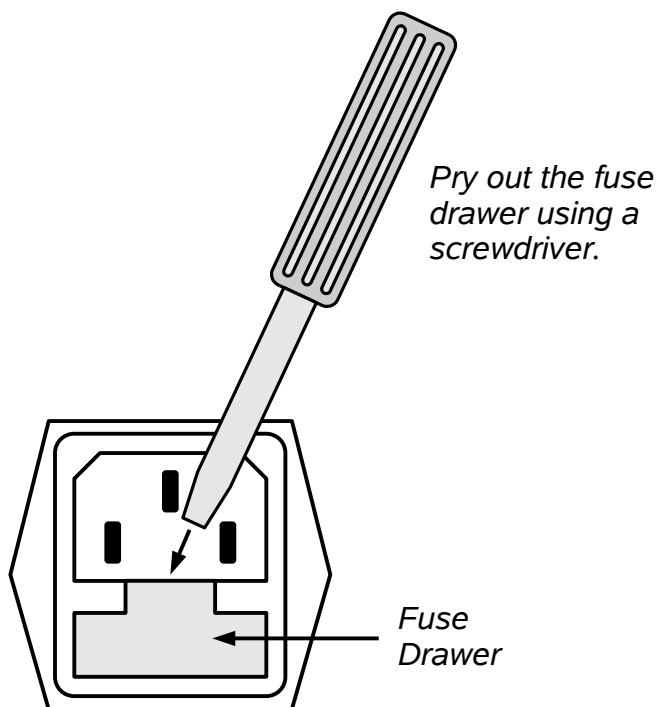

DC FUSE REPLACEMENT

The DC fuses may be replaced by inserting the tip of a flat-head screwdriver into the fuse holder slot, and rotating the slot counter-clockwise. The fuse and its carrier will then pop out.

FUSE RATINGS

The following table lists the required fuses:

Fuses	Nominal Mains Voltage	Rating	Case Size	Recommended Replacement Part	
				Littelfuse Part Number	Digi-Key Stock Number
#1, #2 (AC)	100-240V	0.5A, 250V, Time-Delay	5×20 mm	0218.500HXP	F2416-ND
#3 (DC)	N/A	1.6A, 250V, Time-Delay	5×20 mm	021801.6HXP	F2424-ND
#4 (DC)	N/A	0.5A, 250V, Time-Delay	5×20 mm	0218.500HXP	F2416-ND

The recommended fuse manufacturer is Littelfuse (<http://www.littelfuse.com>).

Replacement fuses may be easily obtained from Digi-Key (<http://www.digikey.com>) and other distributors.

CHASSIS CONFIGURATIONS

The AVRQ-5-B is offered with two basic chassis configurations. The standard model is provided in a “3U” height (in rack units) enclosure, with the DUT area located on the rear panel.

The DUT area may optionally be moved to the front panel by specifying the -FPD option. This is more convenient for the user, but it increases the height of the instrument from 3U to 5U, and higher shipping costs may apply.

STANDARD CONFIGURATION



Front



Rear

-FPD CONFIGURATION



Front



Rear

FRONT PANEL CONTROLS (UNITS WITHOUT -FPD OPTION)

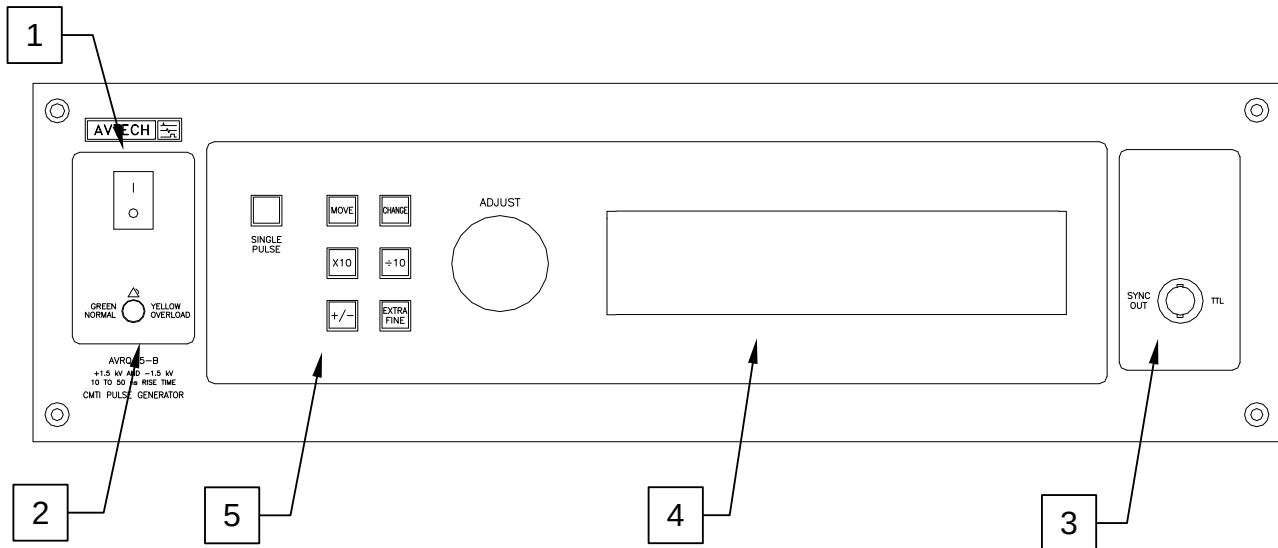

1. **POWER Switch.** This is the main power switch. When turning the instrument on, there is normally a delay of 10 seconds before anything is shown on the main display, as the internal operating system boots up.

If the main menu does not appear after 30 seconds, turn off the instrument and leave it off for at least 60 seconds before applying power again.

2. **OVERLOAD Indicator.** When the instrument is powered, this indicator is normally green, indicating normal operation. If this indicator is yellow, an internal automatic overload protection circuit has been tripped. If the unit is overloaded (by operating at an exceedingly high duty cycle or by operating into a very low impedance), the protective circuit will disable the output of the instrument and turn the indicator light yellow. The light will stay yellow (i.e. output disabled) for about 5 seconds after which the instrument will attempt to re-enable the output (i.e. light green) for about 1 second. If the overload condition persists, the output will be disabled again (i.e. light yellow) for another 5 seconds. If the overload condition has been removed, the instrument will resume normal operation.

This overload indicator may flash yellow briefly at start-up. This is not a cause for concern.

3. **SYNC OUT.** This connector supplies a SYNC output that can be used to trigger other equipment, particularly oscilloscopes. This signal leads (or lags) the main output by a duration set by the "DELAY" controls and has an approximate amplitude of +3 Volts to $R_L > 1 \text{ k}\Omega$ with a pulse width of approximately 100 ns.

4. **LIQUID CRYSTAL DISPLAY (LCD).** This LCD is used in conjunction with the keypad to change the instrument settings. Normally, the main menu is displayed, which

lists the key adjustable parameters and their current values. The “Programming Manual for -B Instruments” describes the menus and submenus in detail.

5. KEYPAD.

Control Name	Function
MOVE	This moves the arrow pointer on the display.
CHANGE	This is used to enter the submenu, or to select the operating mode, pointed to by the arrow pointer.
×10	If one of the adjustable numeric parameters is displayed, this increases the setting by a factor of ten.
÷10	If one of the adjustable numeric parameters is displayed, this decreases the setting by a factor of ten.
+/-	If one of the adjustable numeric parameters is displayed, and this parameter can be both positive or negative, this changes the sign of the parameter.
EXTRA FINE	This changes the step size of the ADJUST knob. In the extra-fine mode, the step size is twenty times finer than in the normal mode. This button switches between the two step sizes.
ADJUST	This large knob adjusts the value of any displayed numeric adjustable values, such as frequency, pulse width, etc. The adjust step size is set by the "EXTRA FINE" button. When the main menu is displayed, this knob can be used to move the arrow pointer.

REAR PANEL CONTROLS (UNITS WITHOUT -FPD OPTION)

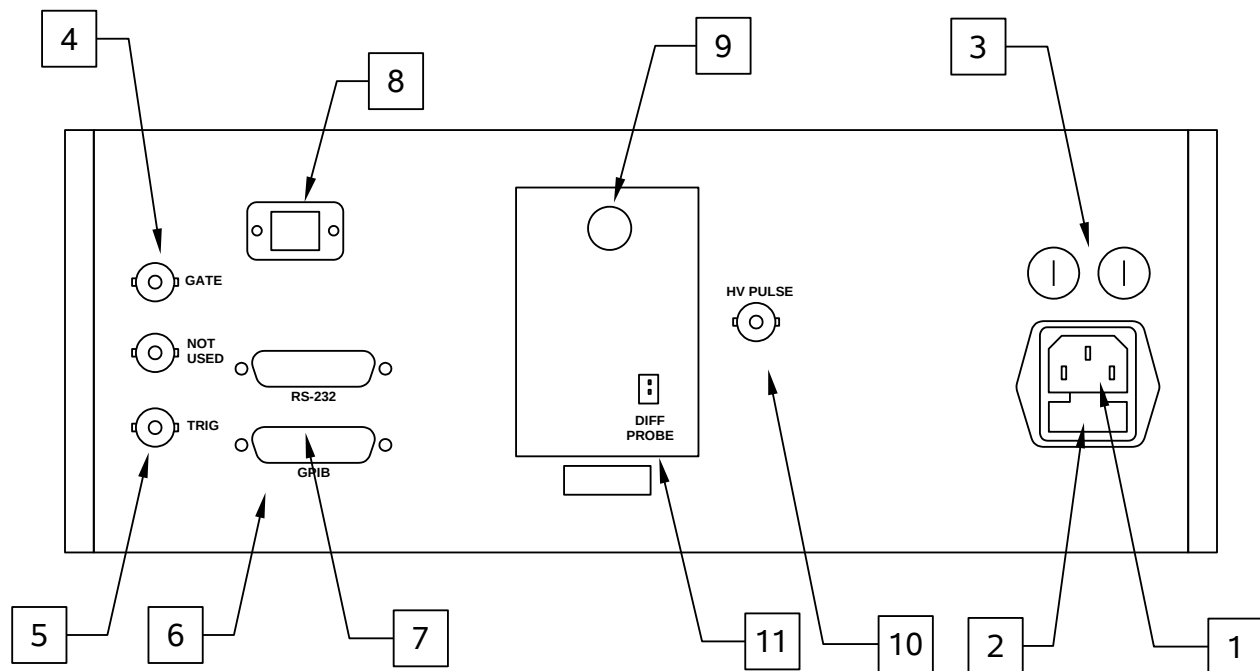

Note: some connectors may be in different positions than shown above, depending on the exact combination of options ordered.

1. AC POWER INPUT. An IEC-320 C14 three-pronged recessed male socket is provided on the back panel for AC power connection to the instrument. One end of the detachable power cord that is supplied with the instrument plugs into this socket.
2. AC FUSE DRAWER. The two fuses that protect the AC input are located in this drawer. Please see the “FUSES” section of this manual for more information.
3. DC FUSES. These two fuses protect the internal DC power supplies. Please see the “FUSES” sections of this manual for more information.
4. GATE. This TTL-level (0 and +5V) logic input can be used to gate the triggering of the instrument. This input can be either active high or active low, depending on the front panel settings or programming commands. (The instrument triggers normally when this input is unconnected). When set to active high mode, this input is pulled-down to ground by a 1 k Ω resistor. When set to active low mode, this input is pulled-up to +5V by a 1 k Ω resistor.
5. TRIG. This TTL-level (0 and +5V) logic input can be used to trigger the instrument, if the instrument is set to triggering externally. The instrument triggers on the rising edge of this input. The input impedance of this input is 1 k Ω . (Depending on the

length of cable attached to this input, and the source driving it, it may be desirable to add a coaxial 50 Ohm terminator to this input to provide a proper transmission line termination. The Pasternack (www.pasternack.com) PE6008-50 BNC feed-thru 50 Ohm terminator is suggested for this purpose.)

6. GPIB Connector. A standard GPIB cable can be attached to this connector to allow the instrument to be computer-controlled. See the “Programming Manual for -B Instruments” for more details on GPIB control.
7. RS-232 Connector. A standard serial cable with a 25-pin male connector can be attached to this connector to allow the instrument to be computer-controlled. A user name (“admin”) and a password (“default”, as shipped from the factory) are required when logging into a serial terminal session. The internal controller attempts to auto-sense the parity setting. It may be necessary to send a few return characters before attempting a login in order to provide enough data to allow this auto-sensing to work. (A standard Linux “agetty” process is used to implement serial control internally.) See the “Programming Manual for -B Instruments” for more details on RS-232 control.
8. Network Connector. (Optional feature. Present on -VXI units only.) This Ethernet connector allows the instrument to be remotely controlled using the VXI-11.3, ssh (secure shell), telnet, and http (web) protocols. See the “Programming Manual for -B Instruments” for more details.
9. DUT Door. This is the door that provides access to the daughterboard ZIF socket. To open it, pull on the chrome knob. When closed, the door is held latched in place magnetically.

The high voltage output is automatically disabled when the DUT door is opened. The door must be closed during tests.

10. HV PULSE CONNECTOR. The BNC connector provides access to the high voltage (± 1.5 kV) pulse that is applied to the DUT, for monitoring purposes. This signal must be observed on an oscilloscope to accurately measure the dV/dt rate of the high voltage pulse.

A Tektronix P5100 high-voltage probe with the 013-0291-00 probe-tip-to-BNC adapter, or a similar arrangement, should be used to connect to this output.

 **CAUTION:** Voltages as high as 1.5 kV may be present on the center conductor of this output connector. Avoid touching this conductor. Connect to this connector using a Tektronix P5100 high-voltage probe with the 013-0291-00 probe-tip-to-BNC adapter, or a similar arrangement, to ensure that the center conductor is not exposed.

 **DO NOT CONNECT THIS OUTPUT DIRECTLY TO AN OSCILLOSCOPE.** The oscilloscope will be damaged by the high voltages. Use a Tektronix P5100 high-voltage probe with the 013-0291-00 probe-tip-to-BNC adapter, or a similar

arrangement.

 DO NOT CONNECT COAXIAL CABLING TO THIS OUTPUT. The capacitance of the cabling will reduce the dV/dt rates noticeably.

11. DIFF OUT Connector. This two-pin header connector connects internally to the logic output of the DUT (and the associated ground). This is the output that is monitored for “glitches” caused by high dV/dt rates on the common mode voltage. It will mate to the Tektronix P6246 differential probe, or to standard 0.1” header sockets. When using the differential probe, install the probe so that the “-” side is on the top, and the “+” side is on the bottom. A differential probe is used to help eliminate noise coupled from the high-voltage signals. Please note that the P6246 has a maximum differential input voltage range of 7V. If higher values of VCC2 are used, a different probe will be required. If a non-differential probe is used, it is best to avoid measuring the low-voltage “DIFF OUT” signal at the same time as a probe is connected to the “HV PULSE” signal. Inter-channel interference in the probes and oscilloscope may introduce significant noise on the low-voltage signal. Instead, measure the signals separately, and use the memory storage function of the oscilloscope if you wish to combine the signals on a single image.

FRONT PANEL CONTROLS (UNITS WITH -FPD OPTION)

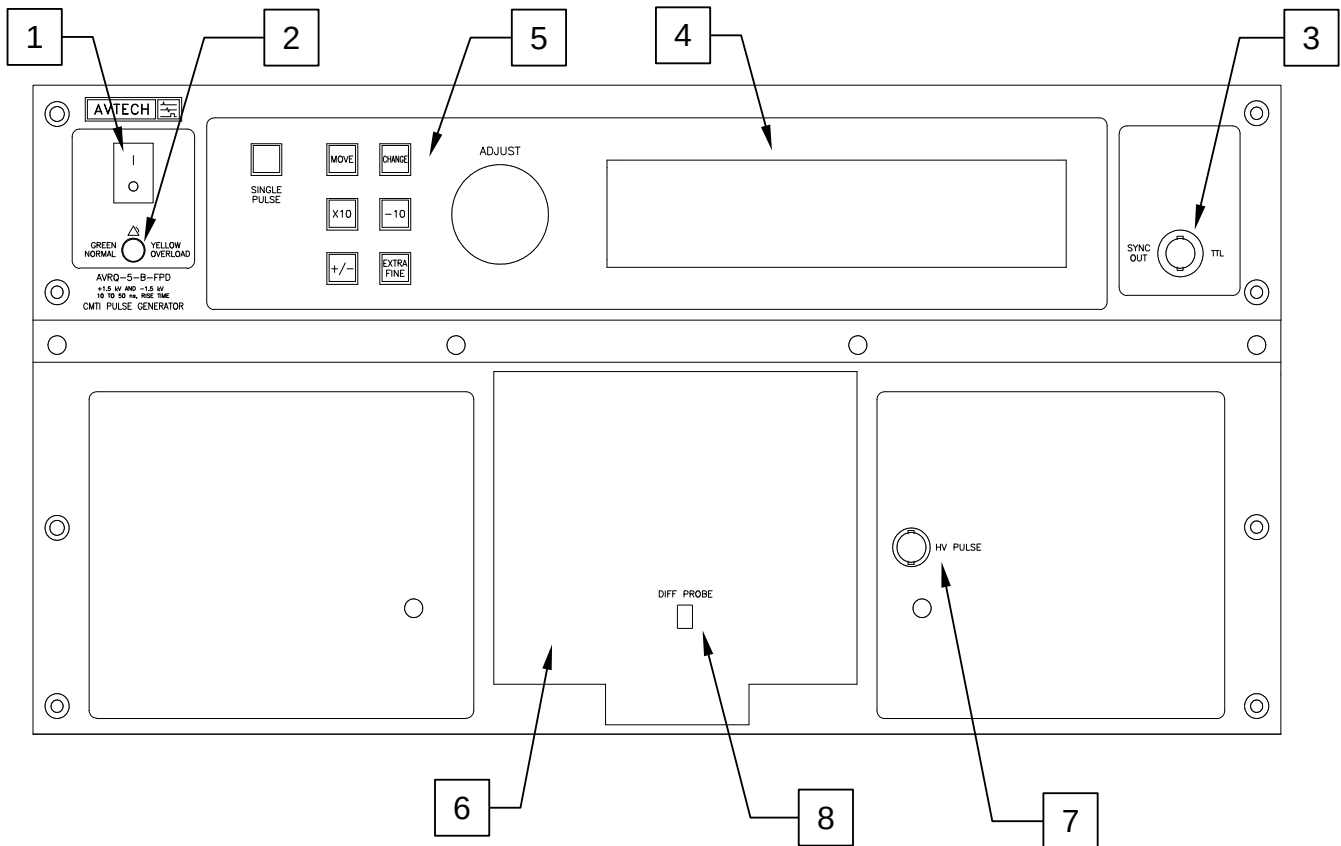

1. **POWER Switch**. This is the main power switch. When turning the instrument on, there is normally a delay of 10 seconds before anything is shown on the main display, as the internal operating system boots up.

If the main menu does not appear after 30 seconds, turn off the instrument and leave it off for at least 60 seconds before applying power again.

2. **OVERLOAD Indicator**. When the instrument is powered, this indicator is normally green, indicating normal operation. If this indicator is yellow, an internal automatic overload protection circuit has been tripped. If the unit is overloaded (by operating at an exceedingly high duty cycle or by operating into a very low impedance), the protective circuit will disable the output of the instrument and turn the indicator light yellow. The light will stay yellow (i.e. output disabled) for about 5 seconds after which the instrument will attempt to re-enable the output (i.e. light green) for about 1 second. If the overload condition persists, the output will be disabled again (i.e. light yellow) for another 5 seconds. If the overload condition has been removed, the instrument will resume normal operation.

This overload indicator may flash yellow briefly at start-up. This is not a cause for concern.

3. SYNC OUT. This connector supplies a SYNC output that can be used to trigger other equipment, particularly oscilloscopes. This signal leads (or lags) the main output by a duration set by the "DELAY" controls and has an approximate amplitude of +3 Volts to $R_L > 1 \text{ k}\Omega$ with a pulse width of approximately 100 ns.
4. LIQUID CRYSTAL DISPLAY (LCD). This LCD is used in conjunction with the keypad to change the instrument settings. Normally, the main menu is displayed, which lists the key adjustable parameters and their current values. The "Programming Manual for -B Instruments" describes the menus and submenus in detail.
5. KEYPAD.

Control Name	Function
MOVE	This moves the arrow pointer on the display.
CHANGE	This is used to enter the submenu, or to select the operating mode, pointed to by the arrow pointer.
×10	If one of the adjustable numeric parameters is displayed, this increases the setting by a factor of ten.
÷10	If one of the adjustable numeric parameters is displayed, this decreases the setting by a factor of ten.
+/-	If one of the adjustable numeric parameters is displayed, and this parameter can be both positive or negative, this changes the sign of the parameter.
EXTRA FINE	This changes the step size of the ADJUST knob. In the extra-fine mode, the step size is twenty times finer than in the normal mode. This button switches between the two step sizes.
ADJUST	This large knob adjusts the value of any displayed numeric adjustable values, such as frequency, pulse width, etc. The adjust step size is set by the "EXTRA FINE" button. When the main menu is displayed, this knob can be used to move the arrow pointer.

6. DUT Door. This is the door that provides access to the daughterboard ZIF socket. To open it, pull on the chrome knob. When closed, the door is held latched in place magnetically.

The high voltage output is automatically disabled when the DUT door is opened. The door must be closed during tests.

7. HV PULSE CONNECTOR. The BNC connector provides access to the high voltage ($\pm 1.5 \text{ kV}$) pulse that is applied to the DUT, for monitoring purposes. This signal must

be observed on an oscilloscope to accurately measure the dV/dt rate of the high voltage pulse.

A Tektronix P5100 high-voltage probe with the 013-0291-00 probe-tip-to-BNC adapter, or a similar arrangement, should be used to connect to this output.

 CAUTION: Voltages as high as 1.5 kV may be present on the center conductor of this output connector. Avoid touching this conductor. Connect to this connector using a Tektronix P5100 high-voltage probe with the 013-0291-00 probe-tip-to-BNC adapter, or a similar arrangement, to ensure that the center conductor is not exposed.

 DO NOT CONNECT THIS OUTPUT DIRECTLY TO AN OSCILLOSCOPE. The oscilloscope will be damaged by the high voltages. Use a Tektronix P5100 high-voltage probe with the 013-0291-00 probe-tip-to-BNC adapter, or a similar arrangement.

 DO NOT CONNECT COAXIAL CABLING TO THIS OUTPUT. The capacitance of the cabling will reduce the dV/dt rates noticeably.

8. DIFF OUT Connector. This two-pin header connector connects internally to the logic output of the DUT (and the associated ground). This is the output that is monitored for “glitches” caused by high dV/dt rates on the common mode voltage. It will mate to the Tektronix P6246 differential probe, or to standard 0.1” header sockets. When using the differential probe, install the probe so that the “-” side is on the top, and the “+” side is on the bottom. A differential probe is used to help eliminate noise coupled from the high-voltage signals. Please note that the P6246 has a maximum differential input voltage range of 7V. If higher values of VCC2 are used, a different probe will be required. If a non-differential probe is used, it is best to avoid measuring the low-voltage “DIFF OUT” signal at the same time as a probe is connected to the “HV PULSE” signal. Inter-channel interference in the probes and oscilloscope may introduce significant noise on the low-voltage signal. Instead, measure the signals separately, and use the memory storage function of the oscilloscope if you wish to combine the signals on a single image.

REAR PANEL CONTROLS (UNITS WITH -FPD OPTION)

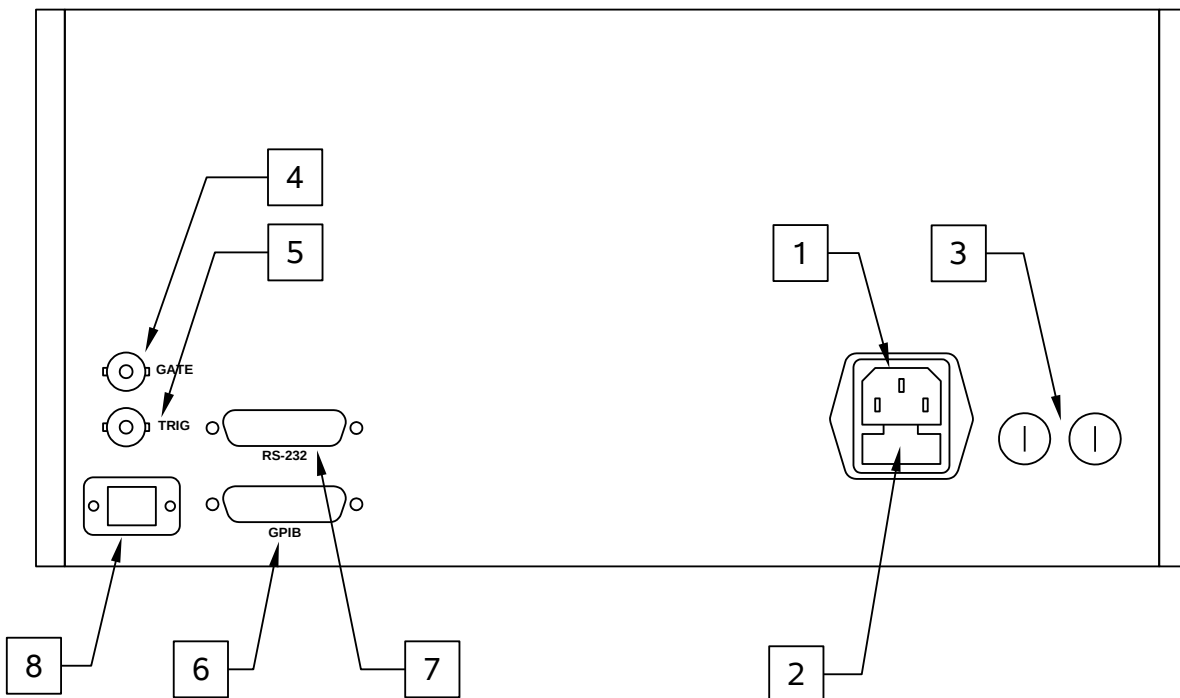

Note: some connectors may be in different positions than shown above, depending on the exact combination of options ordered.

1. AC POWER INPUT. An IEC-320 C14 three-pronged recessed male socket is provided on the back panel for AC power connection to the instrument. One end of the detachable power cord that is supplied with the instrument plugs into this socket.
2. AC FUSE DRAWER. The two fuses that protect the AC input are located in this drawer. Please see the “FUSES” section of this manual for more information.
3. DC FUSES. These two fuses protect the internal DC power supplies. Please see the “FUSES” sections of this manual for more information.
4. GATE. This TTL-level (0 and +5V) logic input can be used to gate the triggering of the instrument. This input can be either active high or active low, depending on the front panel settings or programming commands. (The instrument triggers normally when this input is unconnected). When set to active high mode, this input is pulled-down to ground by a 1 k Ω resistor. When set to active low mode, this input is pulled-up to +5V by a 1 k Ω resistor.
5. TRIG. This TTL-level (0 and +5V) logic input can be used to trigger the instrument, if the instrument is set to triggering externally. The instrument triggers on the rising

edge of this input. The input impedance of this input is 1 k Ω . (Depending on the length of cable attached to this input, and the source driving it, it may be desirable to add a coaxial 50 Ohm terminator to this input to provide a proper transmission line termination. The Pasternack (www.pasternack.com) PE6008-50 BNC feed-thru 50 Ohm terminator is suggested for this purpose.)

6. GPIB Connector. A standard GPIB cable can be attached to this connector to allow the instrument to be computer-controlled. See the “Programming Manual for -B Instruments” for more details on GPIB control.
7. RS-232 Connector. A standard serial cable with a 25-pin male connector can be attached to this connector to allow the instrument to be computer-controlled. A user name (“admin”) and a password (“default”, as shipped from the factory) are required when logging into a serial terminal session. The internal controller attempts to auto-sense the parity setting. It may be necessary to send a few return characters before attempting a login in order to provide enough data to allow this auto-sensing to work. (A standard Linux “agetty” process is used to implement serial control internally.) See the “Programming Manual for -B Instruments” for more details on RS-232 control.
8. Network Connector. (Optional feature. Present on -VXI units only.) This Ethernet connector allows the instrument to be remotely controlled using the VXI-11.3, ssh (secure shell), telnet, and http (web) protocols. See the “Programming Manual for -B Instruments” for more details.

GENERAL INFORMATION

BASIC PULSE CONTROL

This instrument can be triggered by its own internal clock or by an external TTL trigger signal. In either case, two output channels respond to the trigger: HV PULSE and SYNC. The HV PULSE channel is the signal that is applied to the DUT. Its amplitude is fixed, but the polarity is switchable. The SYNC pulse is a fixed-width TTL-level reference pulse used to trigger oscilloscopes or other measurement systems. When the delay is set to a positive value the SYNC pulse precedes the HV PULSE pulse. When the delay is set to a negative value the SYNC pulse follows the HV PULSE pulse.

These pulses are illustrated below, assuming internal triggering, a positive delay, and positive amplitude:

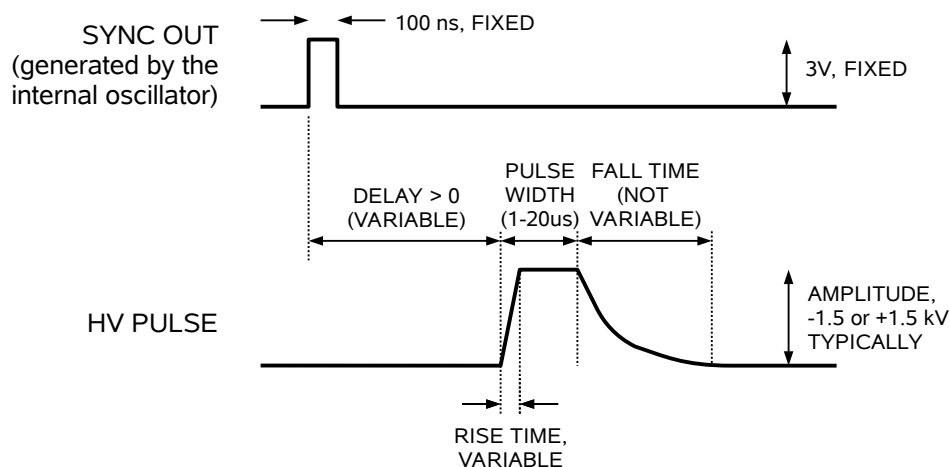

If the delay is negative, the order of the SYNC and OUT pulses is reversed:

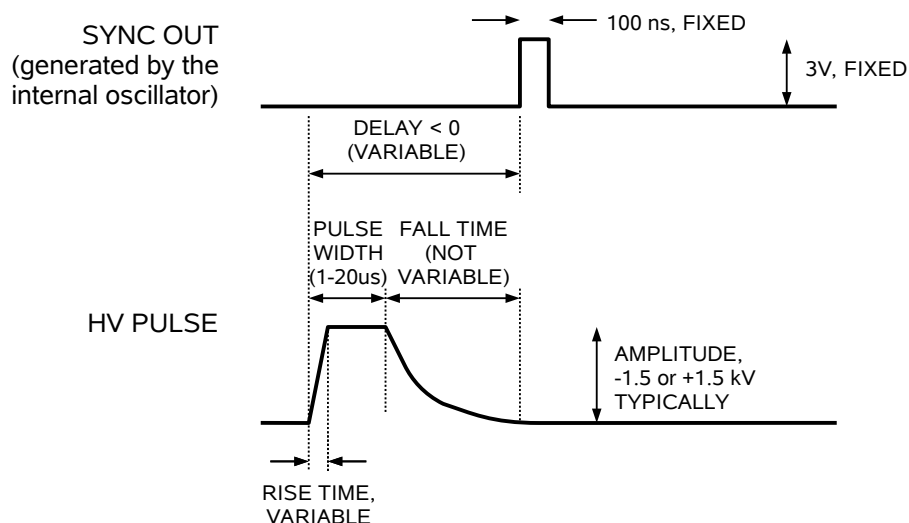

The next figure illustrates the relationship between the signals when an external TTL-level trigger is used:

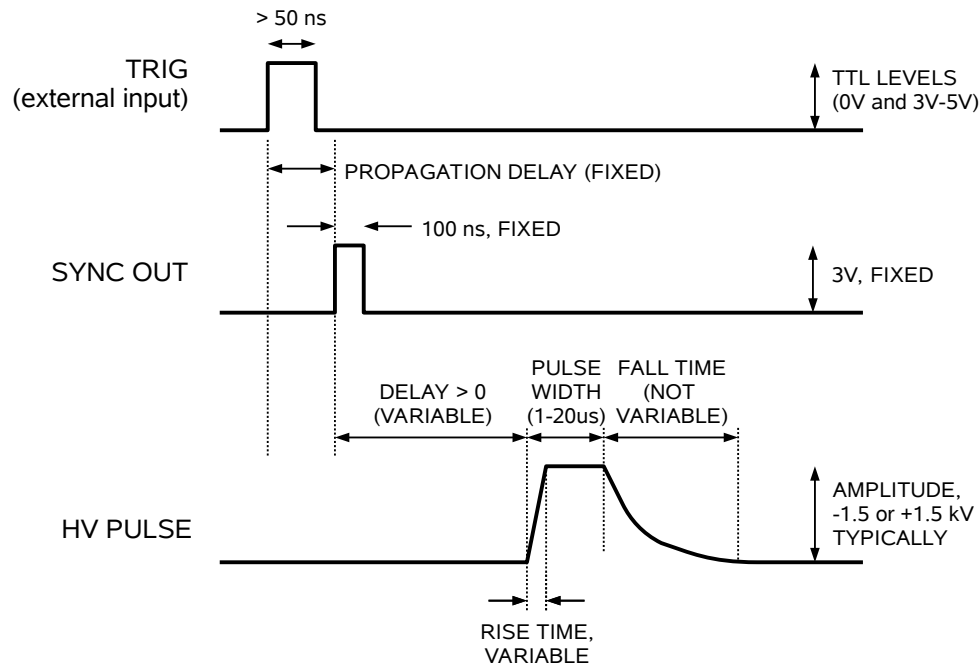

As before, if the delay is negative, the order of the SYNC and OUT pulses is reversed.

The delay and frequency (when in the internal mode), of the OUT pulse can be varied with front panel controls or via the GPIB or RS-232 computer interfaces.

TRIGGER MODES

This instrument has four trigger modes:

- Internal Trigger: the instrument controls the trigger frequency, and generates the clock internally.
- External Trigger: the instrument is triggered by an external TTL-level clock on the back-panel TRIG connector.
- Manual Trigger: the instrument is triggered by the front-panel "SINGLE PULSE" pushbutton.
- Hold Trigger: the instrument is set to not trigger at all.

These modes can be selected using the front panel trigger menu, or by using the appropriate programming commands. (See the “Programming Manual for -B Instruments” for more details.)

GATING MODES

Triggering can be suppressed by a TTL-level signal on the rear-panel GATE connector. The instrument can be set to stop triggering when this input high or low, using the front-panel gate menu or the appropriate programming commands. This input can also be set to act synchronously or asynchronously. When set to asynchronous mode, the GATE will disable the output immediately. Output pulses may be truncated. When set to synchronous mode, the output will complete the full pulse width if the output is high, and then stop triggering. No pulses are truncated in this mode.

DUT INSTALLATION

SOCKET PINOUT

A daughterboard arrangement is used to accommodate difference device packages and bias conditions. A zero-insertion force (ZIF) socket accepts these daughterboards.

The AVRQ-5-B mainframe provides the high-voltage common mode pulse (which is tied to GND1), and VCC2 / GND2 (the non-floating output-side power supply). The user is responsible for configuring the daughterboards to implement the correct input side power (VCC1), biasing, filtering, loading, socketing, and glitch measurement. The included sample boards implement these requirements for common DIP8 devices, using configurable jumpers/resistors/capacitors. A probe point is provided on the main circuit board for observation of the device logic output with a user-provided probe and oscilloscope.

The ground-referenced output-side power (VCC2) is generated by the mainframe, and is adjustable (+3V to +43V, 150 mA maximum). The floating input-side power is not provided by the mainframe. Instead, an A23-type 12V battery should be installed on the DUT daughterboard to provide a floating power source, along with a basic regulator circuit to provide the necessary regulated +5V power (VCC1). A isolated battery arrangement is used to ensure that the VCC1 power supply is not the source of any glitches observed in the operation of the DUT.

The AVRQ-5-B provides a zero-insertion force (ZIF) socket into which the daughterboard may be plugged. The simplified circuit diagram of the ZIF socket on the mainframe is shown below:

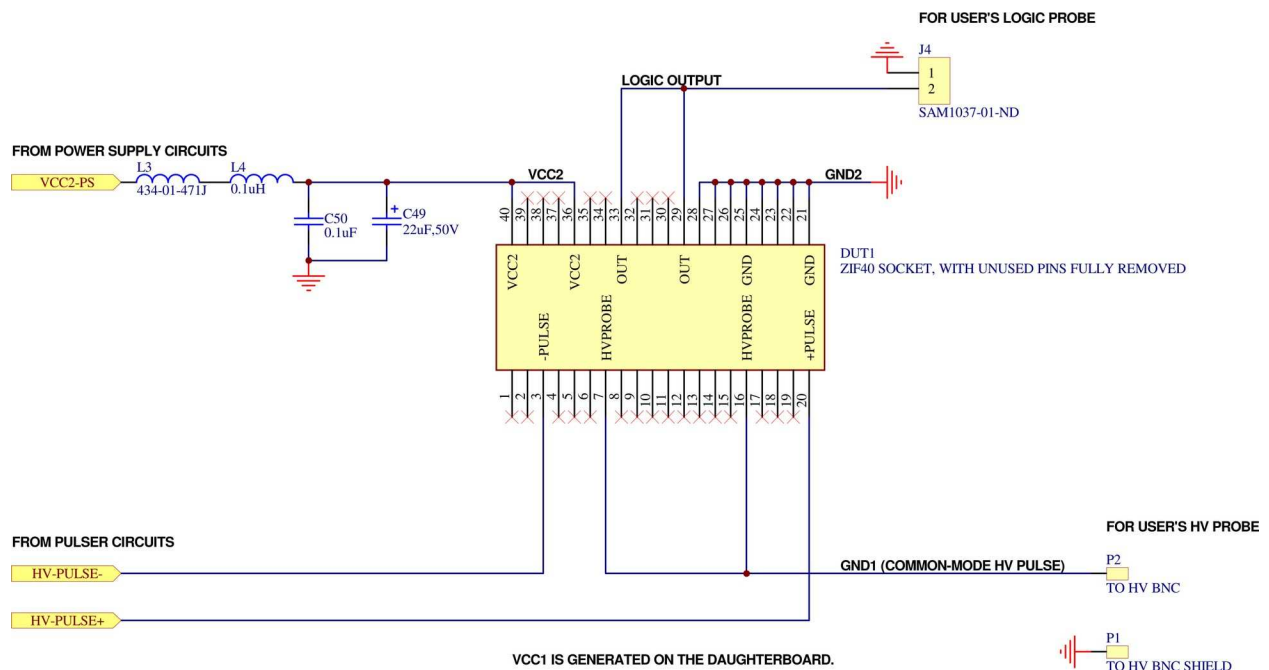

The socket and the sample daughterboards are designed so that the daughterboard can be installed in two positions – one for positive pulse mode, and one for negative pulse mode. This is explained further in the next section.

DAUGHTERBOARD PINOUT

The sample daughterboards have the pinout shown below:

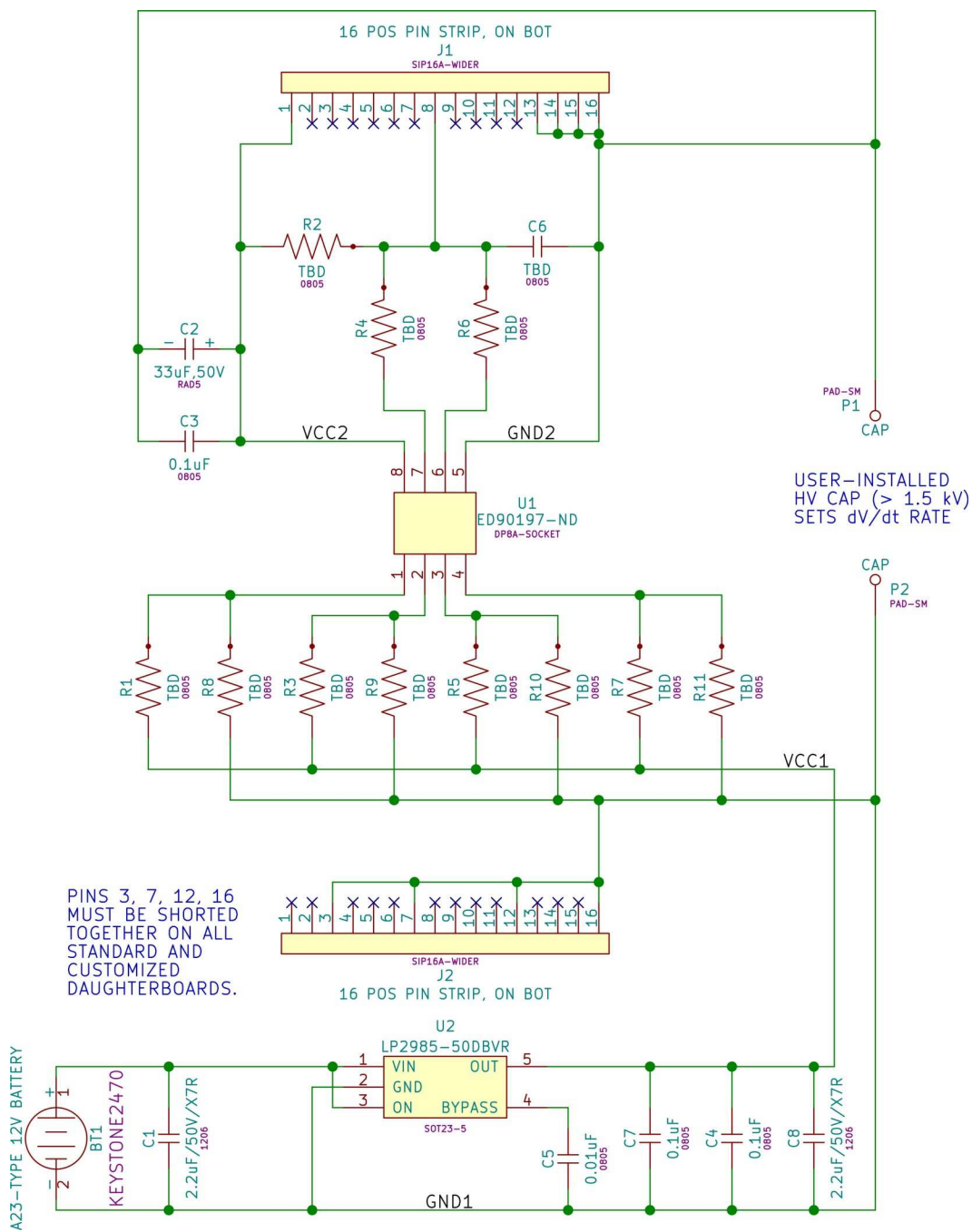

For positive pulse mode, the “AMP1” front-panel setting must be set to a positive value *AND* the daughterboard must be installed in the socket so that it is in the left-most position (when viewed from the DUT area door opening), closest to the socket lever, like this:

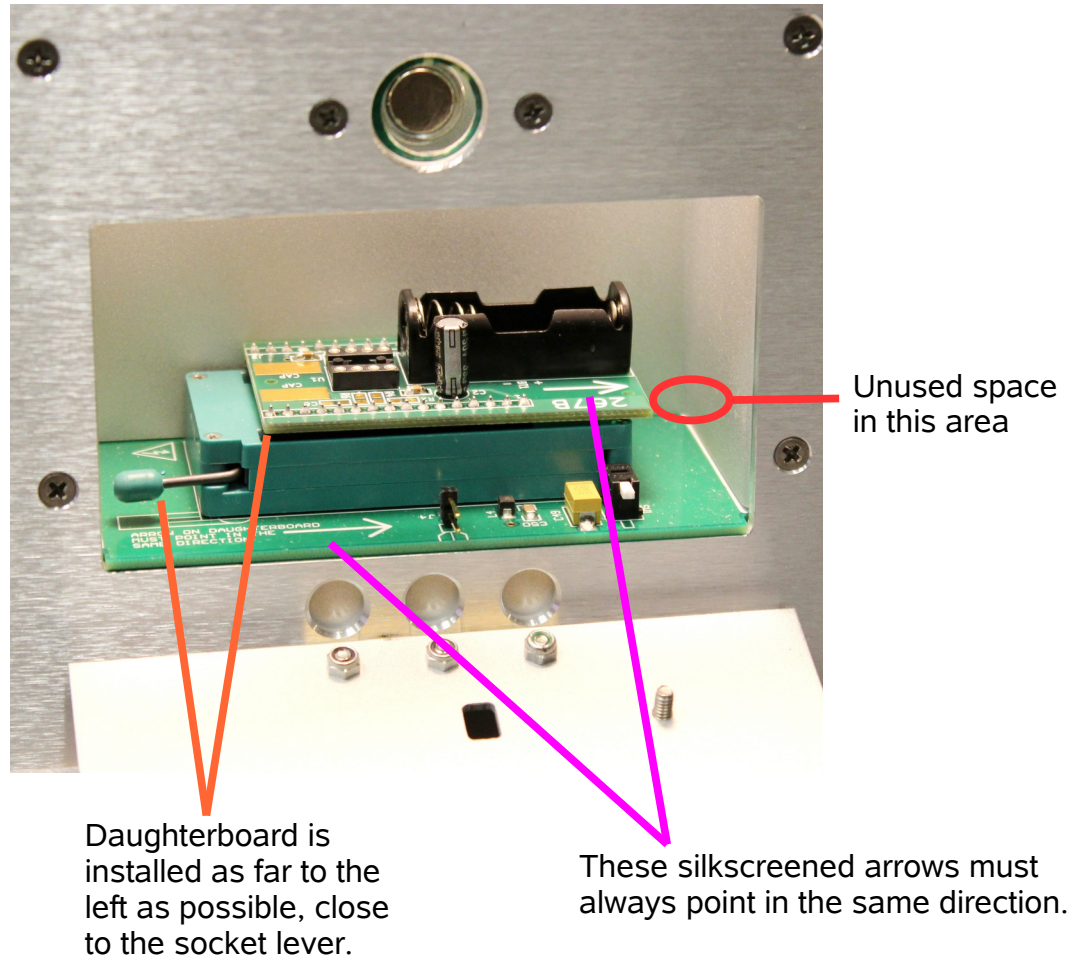

DAUGHTERBOARD INSTALLED FOR POSITIVE PULSE OPERATION

In this configuration, pins J2:1 to J2:16 on the daughterboard mate to pins 5 to 20 of the ZIF socket, and pins J1:1 to J1:16 on the daughterboard mate to pins 36 to 21 on the ZIF socket. The positive pulse generator (ZIF pin 20) applies a pulse to J2:16, and this pulse is also fed to the BNC connector on the panel through a daughterboard track to J2:12 / ZIF pin 16. VCC2 is applied to ZIF pin 36 / J1:1. Chassis ground (GND2) is provided at ZIF pins 21-24 / J1:13-16. The ground-referenced logic output is provided at ZIF pin 29 / J1:8.

For negative pulse mode, the “AMP1” front-panel setting must be set to a negative value *AND* the daughterboard must be installed in the socket so that it is in the right-

most position (when viewed from the DUT area door opening), farthest from the socket lever, like this:

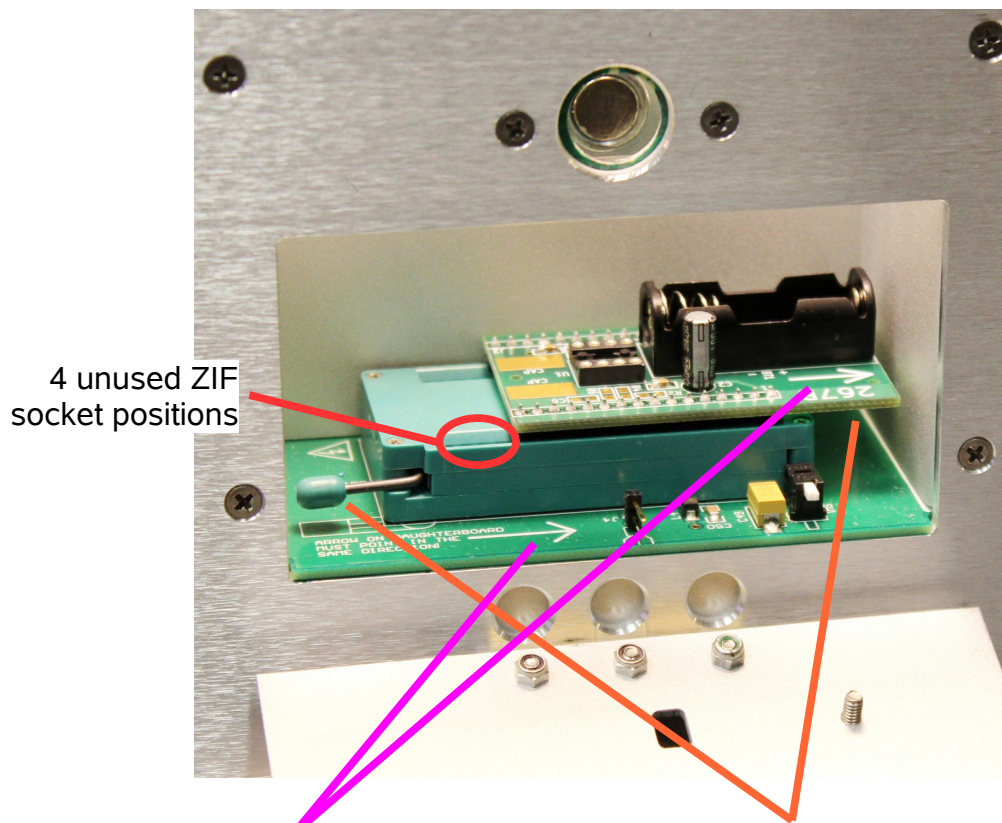

These silkscreened arrows must always point in the same direction.

Daughterboard is installed as far to the right as possible, farthest from the lever.

DAUGHTERBOARD INSTALLED FOR NEGATIVE PULSE OPERATION

In this configuration, pins J2:1 to J2:16 on the daughterboard mate to pins 1 to 16 of the ZIF socket, and pins J1:1 to J1:16 on the daughterboard mate to pins 40 to 25 on the ZIF socket. The negative pulse generator (ZIF pin 3) applies a pulse to J2:3, and this pulse is also fed to the BNC connector on the panel through a daughterboard track to J2:7 / ZIF pin 7. VCC2 is applied to ZIF pin 40 / J1:1. Chassis ground (GND2) is provided at ZIF pins 25-28 / J1:13-16. The ground-referenced logic output is provided at ZIF pin 33 / J1:8.

⚠ THESE ARE THE ONLY TWO CORRECT POSITIONS. DO NOT INSTALL THE DAUGHTERBOARDS IN ANY OTHER WAY.

 ALWAYS ENSURE THAT THE SILKSCREENED ARROW ON THE DAUGHTERBOARD IS POINTING IN THE SAME DIRECTION AS THE ARROW ON THE MAINFRAME, AS SHOWN IN THE PHOTOS ABOVE. The instrument will not be damaged by inserting the daughterboard in the wrong position, as long as the arrows are aligned. If the daughterboard is oriented 180° relative to its correct orientation (i.e., the arrows point in opposite directions), the instrument may be damaged during operation. The daughterboard is designed to hit the ZIF lever if it is inserted in the wrong orientation, to alert the user to the error.

Two physical positions are used to achieve polarity switching, rather than using internal high-voltage relays, in order to achieve the fastest possible switching times. The parasitic inductance and capacitance added by physically-large high-voltage relays would degrade performance noticeably. The front-panel AMP1 setting determines which of the two internal pulse generator circuits (+ and -) is active. Only one is active at a time, to avoid interference.

DAUGHTERBOARD COMPONENTS

The circuit diagram for the included sample daughterboards shown on page 34 includes more than just the socket for the 8-pin DUT.

A battery holder (BT1) is provided to hold one A23-type 12V battery. When installed by the user, this battery will apply +12V to the regulator IC (U2), which provides a floating +5.0V power source (VCC1) to the DUT. An A23 battery is supplied with each sample daughterboard, and additional ones can be easily purchased from Digi-Key (see stock number N403-ND, www.digikey.com/product-detail/en/A23C/N403-ND). The battery is not required if the DUT does not require a voltage or current bias (for example, when testing current-drive opto-couplers in the LED “off” state).

A number of bypass capacitors are installed by default.

Two resistor footprints are associated with each of pins 1 – 4 of the DUT, allowing these pins to be individually tied to VCC1, GND1, or be left open.

Resistor footprints R4 and R6 allow either pin 6 or 7 (or both) of the DUT to be used as the logic output. R2 can be used to pull-up the DUT output (if it is an open-collector output, in particular) and C6 can be used to add a load capacitance to the logic output. These component values are sometimes specified by particular test standards.

 The user will need to configure R1-R11 and C6 as appropriate for the DUT.

Lastly, two solder pads (P1 and P2 in the schematic, both are labeled “CAP” on the actual PCB) are provided. A high-voltage ceramic capacitor (rated for at least 1.5 kV) may be soldered between these two pads in order to increase the rise time of the pulse. With no capacitance installed, switching times of < 10 ns (10%-90%) are normally obtainable. Adding capacitance will typically degrade the rise time by 1 ns per 6 pF, up

to a limit of ~ 600 pF. (Best results, in terms of waveform linearity, will be obtained for values of 0 - 300 pF).

 Do not exceed 600 pF, or the switching transistors may become overstressed and fail.

The design files for the sample daughterboard (Avtech PCB 267C) are available for download at https://www.avtechpulse.com/semiconductor/avrq-5/#support_files.

The function of the various components is summarized below:

Reference	Footprint	Installed Value	Normally Modified by User	Typical Function
C1	1206	2.2uF,50V,X7R	No	VCC1 decoupling
C2	RAD5	33uF,50V		VCC2 decoupling
C3	0805	0.1uF		VCC2 decoupling
C4	0805	0.1uF		VCC1 decoupling
C5	0805	0.01uF		VCC1 decoupling
C7	0805	0.1uF		VCC1 decoupling
C8	1206	2.2uF,50V,X7R		VCC1 decoupling
U1	DP8A-SOCKET	DIP8 SOCKET		DUT socket
J1	SIP16A-WIDER	CONN16		Mates with ZIF socket
J2	SIP16A-WIDER	CONN16		Mates with ZIF socket
U2	SOT23-5	LP2985-50DBVR		Low-dropout 5V regulator VCC1
C6	0805	-		Yes
R1		-	Zero-Ohm Jumper to connect DUT pin 1 to VCC1	
R2		-	Output pullup	
R3		-	Resistance to connect DUT pin 2 to VCC1. Non-zero resistance for current-drive inputs.	
R4		-	Zero-Ohm Jumper for DUT pin 7 as logic output	
R5		-	Resistance to connect DUT pin 3 to VCC1	
R6		-	Zero-Ohm Jumper for DUT pin 6 as logic output	
R7		-	Resistance to connect DUT pin 4 to VCC1	
R8		-	Zero-Ohm Jumper to connect DUT pin 1 to GND1	
R9		-	Zero-Ohm Jumper to connect DUT pin 2 to GND1	
R10		-	Zero-Ohm Jumper to connect DUT pin 3 to GND1	
R11	-	Zero-Ohm Jumper to connect DUT pin 4 to GND1		
P1	PAD-SM	-		Pads for rise time capacitor. Do not exceed 600 pF.
P2				
BT1	KEYSTONE2470	-		One user-installed A23-type 12V battery, prime power for VCC1.(Please note that A23 batteries have a limited mA·hr rating – typically 30 mA·hr when operating at 15 mA – so the battery should be removed immediately after testing, and its output should verified to be between 6V and 12V before each test.)

CUSTOM DAUGHTERBOARDS

The daughterboards provided with the AVRQ-5-B are meant as samples.

The user may construct their own daughterboards, which may incorporate a preferred physical layout, different bias circuits, or different DUT packages and socketing.

 When designing your own daughterboard, take care to isolate the input and output sides as much as possible, to both provide sufficient high-voltage clearance and to minimize parasitic coupling of the HV pulse onto the output signal.

 If the user designs a custom daughterboard, the same connections must be made to the 32 pins of the daughterboard. That is, pins 3, 7, 12, and 16 on J1 (GND1) must be shorted together, VCC2 must go to J1:1, GND2 to J1:13-16, and the logic output to J1:8.

The battery occupies a relatively large portion of the top side of the standard daughterboard. It may be necessary to locate the footprints for large SMT DUTs (e.g., 32-pin SOICs) on the bottom side of the PCB. It may also be possible to mount the battery vertically to provide more DUT space on the top side.

Do not use coin batteries to power the floating side of the DUT. They are normally severely restricted in their output current rating and can not supply the 2-20 mA typically required to power the floating side of the DUT, regardless of their mA·hr rating. The A23-style 12V battery has an appropriate combination of voltage output, current rating, and physical size.

The sample daughterboard uses a simple DIP socket for the DUT, rather than the more convenient ZIF-style of socket. This is done because ZIF sockets have higher parasitic capacitance between the various pins, which can be very harmful to the DUT's CMTI performance. Avoid ZIF sockets for the DUT. (A ZIF socket is used for the daughterboard installation, but parasitic capacitances there do not degrade the measured DUT's CMTI.)

DIFFERENTIAL PROBING

The mainframe uses a two-pin header near the DUT area door to transmit the output waveform to a user-supplied Tektronix P6246 differential probe. The use of a differential probe helps reduce spurious transient signal artefacts on the oscilloscope, which are typically caused by ground bounce and interference in general.

When designing custom daughterboards, a similar approach should be used.

Please note that the P6246 has a maximum differential input voltage range of 7V. If higher values of VCC2 will be used, a different probe will be required. Other probes may be used by installing a matching two-pin socket as an extender.

If a non-differential probe is used, it is best to avoid measuring the low-voltage “DIFF OUT” signal at the same time as a probe is connected to the “HV PULSE” signal. Inter-channel interference in the probes and oscilloscope may introduce significant noise on the low-voltage signal. Instead, measure the signals separately, and use the memory storage function of the oscilloscope if you wish to combine the signals on a single image.

INSTALLING THE DAUGHTERBOARDS

To install a daughterboard, first turn off the instrument. (The instrument will disable the high-voltage circuitry automatically if the DUT door is opened, but it is better practice to turn off the instrument entirely.)

Install the desired 8-pin DIP device in the DIP socket on the loose daughterboard.

If necessary for input biasing and/or VCC1 generation, install an A23-type battery on the daughterboard. Confirm that it is generating >6V once it is installed in the battery holder.

Open the rear-panel DUT door. Raise the lever on the left side of the ZIF socket to open the individual pin clamps.

Using tweezers, carefully lower the daughterboard into the left-most positive (for positive tests) or the right-most position (for negative tests).

 ALWAYS ENSURE THAT THE SILKSCREENED ARROW ON THE DAUGHTERBOARD IS POINTING IN THE SAME DIRECTION AS THE ARROW ON THE MAINFRAME, AS SHOWN IN THE PHOTOS ON PREVIOUS PAGES.

Lower the ZIF socket lever to lock the daughterboard in place.

Close the DUT door. Ensure that the instrument has been turned off for at least 60 seconds before turning it back on, to allow the embedded controller to reset properly. Then turn on the instrument and proceed with your tests.

When testing is finished, turn off the instrument, open the DUT door, raise the ZIF lever, and gently use tweezers to lift the daughterboard up out of the socket.

Remove the DUT and A23-type battery.

BASIC TEST ARRANGEMENTS

The figure below shows the basic test arrangement for the AVRQ-5-B, with one possible DUT daughterboard configuration, with the daughterboard installed for positive pulse operation and a high-current input bias on the LED:

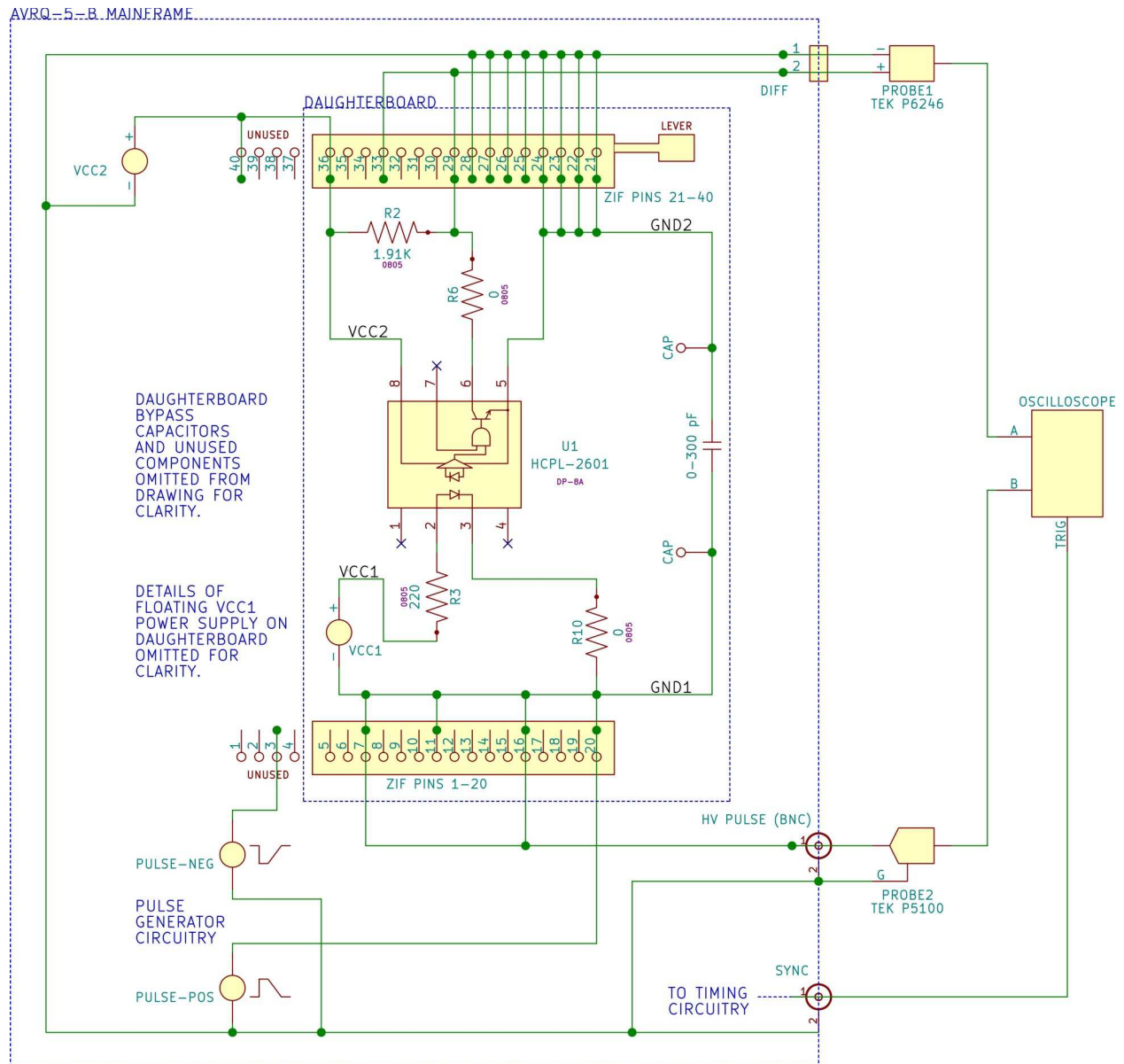

In the above drawing, an HCPL-2601 current-drive opto-coupler is installed on the daughterboard, and the daughterboard is configured to drive the opto-coupler input with ~ 16 mA of current (using VCC1 and a 220 Ohm resistance). The daughterboard is positioned as close as possible to the socket lever in order to connect the daughterboard to the positive pulse circuitry.

The figure below shows another basic test arrangement, with the daughterboard installed for negative pulse operation and zero input bias on the LED:

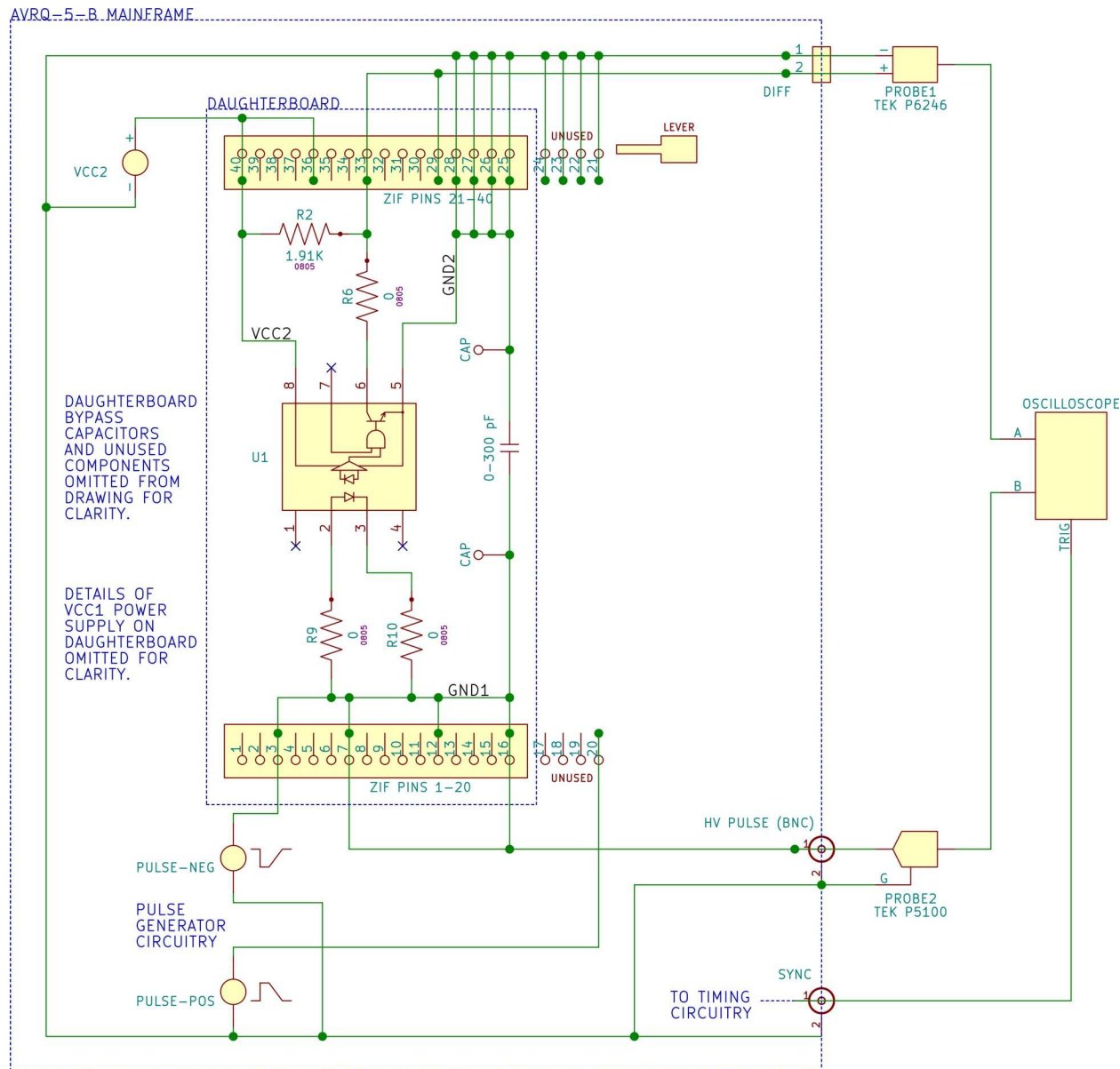

In the above drawing, an HCPL-2601 current-drive opto-coupler is installed on the daughterboard, and the daughterboard is configured to drive the opto-coupler input with zero current (by jumpering pins 2 and 3 to GND1). The daughterboard is positioned as far as possible to the socket lever in order to connect the daughterboard to the negative pulse circuitry.

To connect the AVRQ-5-B properly, do the following:

- 1) With the power off, install an appropriately-configured daughterboard and DUT, as described in the previous sections.
- 2) Connect the SYNC output (on the front panel) to the external trigger input of the oscilloscope using (user-supplied) coaxial cabling.
- 3) Connect the (user-supplied) Tektronix P5100 probe to the rear-panel HV PULSE connector using the (user-supplied) Tektronix 013-0291-00 probe-to-BNC adapter, or a similar arrangement.
- 4) With the DUT door closed, gently insert the Tektronix P6246 differential probe to mate with the output header on the daughterboard. The “+” side of the probe should be down. Please note that the P6246 has a maximum differential input voltage range of 7V. If higher values of VCC2 will be used, a different probe will be required.
- 5) Power-up the AVRQ-5-B and the oscilloscope.

 Caution: The HV PULSE oscilloscope probe must be rated for operation at 1.5 kV (pulsed) or higher. Factory tests are conducted using a Tektronix P5100 probe, which has a 2.5 kV peak rating and a 1000:1 division ratio. (Remember to adjust the compensation of the probe to match your oscilloscope input.)

INTER-CHANNEL INTERFERENCE

The test arrangements on the preceding pages show both the high-voltage pulse and the logic output being measured on the oscilloscope at the same time.

In practice, better results are obtained if the logic waveform is measured with the high-voltage probe disconnected from the “HV PULSE” output. Otherwise, some of the very-fast, very-high-voltage signal may couple to the low-voltage logic input through parasitic capacitances in the oscilloscope and its cabling. This sort of interference is typically quite sensitive to the exact positioning of the probe cabling.

If you observe this sort of interference, measure the signals one at a time, and use the memory-storage feature of your oscilloscope if you wish to record them on the same waveform photo.

TYPICAL WAVEFORMS FOR STANDARD DAUGHTERBOARDS

BASIC THEORY

The user will install a DUT on a daughterboard. The daughterboard configuration determines the input bias to the opto-coupler, as well as the output loading.

The AVRQ-5-B front panel settings control whether the positive or negative pulse generator circuit is active internally. The daughterboard must be positioned in the ZIF socket to match this setting (i.e., as close as possible to the ZIF lever for positive mode, and as far as possible from the ZIF lever for the negative mode).

The AVRQ-5-B front panel settings also control the DC voltage applied to VCC2 (+3 to +43V, adjustable, 150 mA maximum). This is the opto-coupler output-side bias. GND2 is connected to chassis ground.

The opto-coupler input-side bias is controlled by the circuitry installed on the daughterboard, as explained in previous sections. If a non-zero voltage or current bias is required, then an A23-type 12V battery must be installed in the battery holder on the daughterboard. (Please note that A23 batteries have a limited mA·hr rating – typically 30 mA·hr when operating at 15 mA – so the battery should be removed immediately after testing, and its output should be verified to be between 6V and 12V before each test.)

As an example, the HV pulse might be set to a positive amplitude (+1.5 kV), with the input anode and cathode both connected to GND1 (zero current bias). In this mode, the output voltage should be pulled-up to VCC2. However, as the rise time of the HV pulse is reduced, the interference caused by the fast pulse may cause a “glitch” to appear on the output, where the output changes state (or come close to it). This is illustrated below:

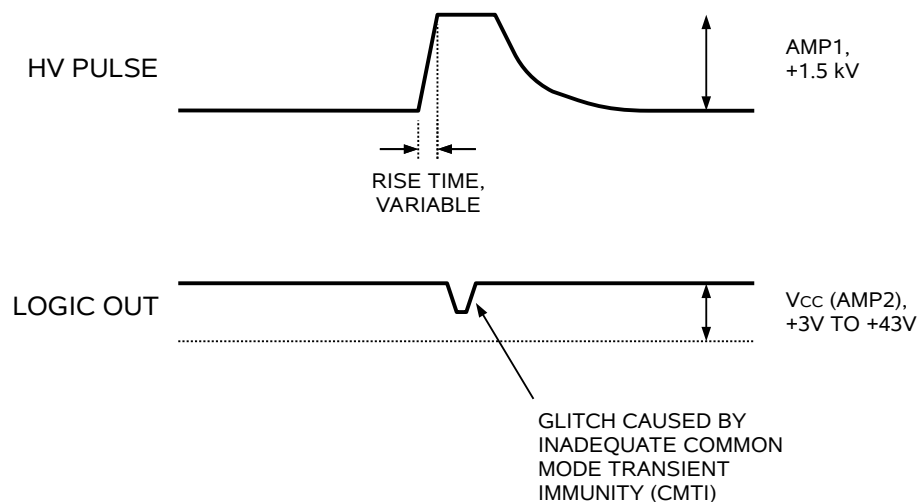

The next illustration shows a similar glitch occurring for a negative high-voltage pulse, where the input has been biased “on” to provide a normally-zero output voltage:

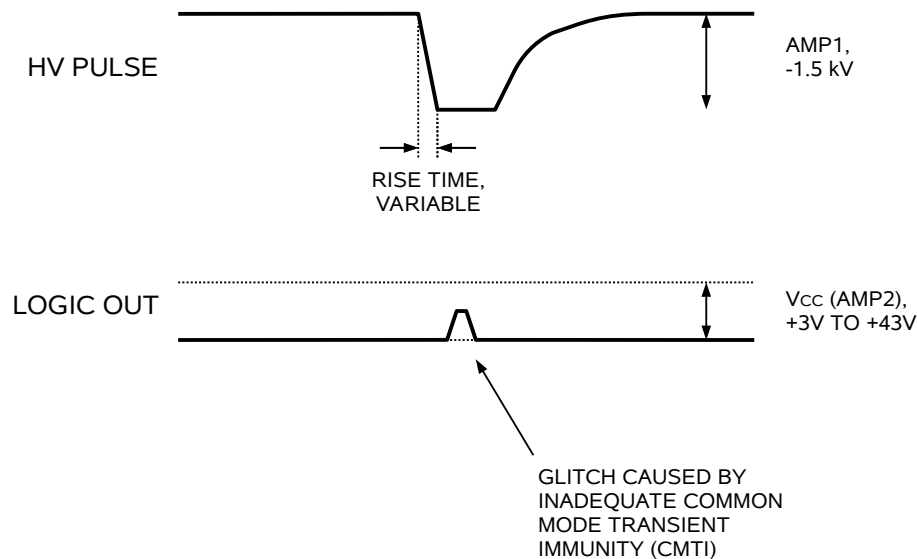

CONTROLLING THE TRANSITION TIME

The positive and negative pulse generators in the AVRQ-5-B are basically switched current sources. The voltage rise time can be controlled by deliberately soldering capacitance between the two “CAP” pads on the daughterboards (between the GND1 and GND2 signals). This capacitance should be added using high-voltage (> 2 kV) ceramic capacitors. Factory tests are conducted using Vishay Cera-Mite 564R-series capacitors, which are readily available for purchase from Newark. Some of the tests below use series or parallel combinations of part number 564R30GAT15, which is a 150 pF / 3 kV capacitor: <http://www.newark.com/vishay-sprague/564r30gat15/ceramic-capacitor-150pf-3000v/dp/69K5347>.

The photo below shows a 564R30GAT15 capacitor installed:

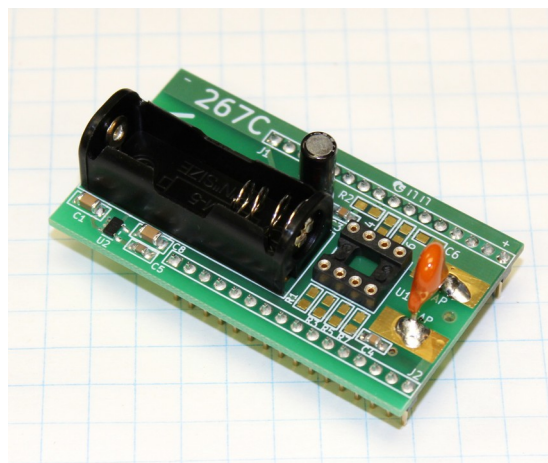

TYPICAL POSITIVE RESULTS, WITH NO DUT INSTALLED

The photos below show typical “HV PULSE” waveforms with with AMP1 = +1.5 kV, and a daughterboard installed in the ZIF socket in the positive position (silkscreen arrows pointing same direction, daughterboard is as close as possible to the ZIF lever), but with no DUT installed in the DIP8 socket on the daughterboard:

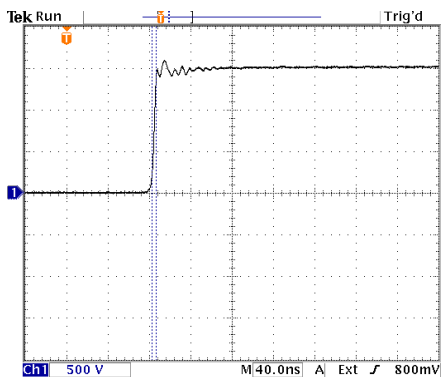

$C = 0 \text{ pF}$, $t_{R10-90} = 4.482 \text{ ns}$

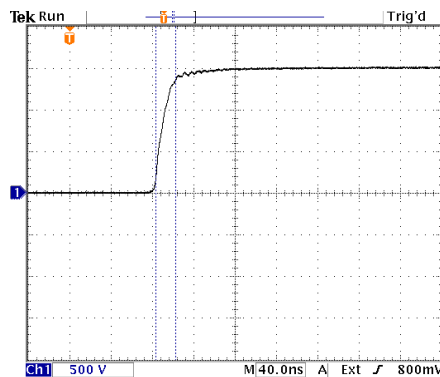

$C = 75 \text{ pF}$, $t_{R10-90} = 19.28 \text{ ns}$

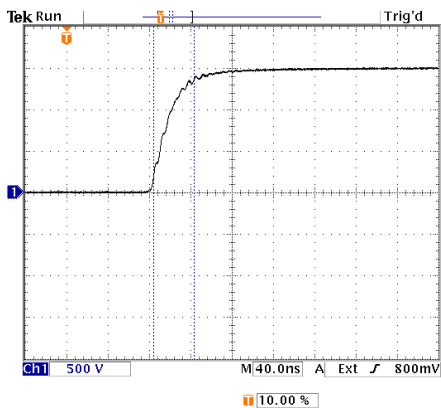

$C = 150 \text{ pF}$, $t_{R10-90} = 39.30 \text{ ns}$

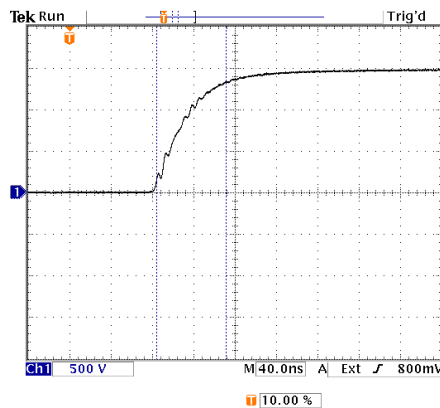

$C = 300 \text{ pF}$, $t_{R10-90} = 66.70 \text{ ns}$

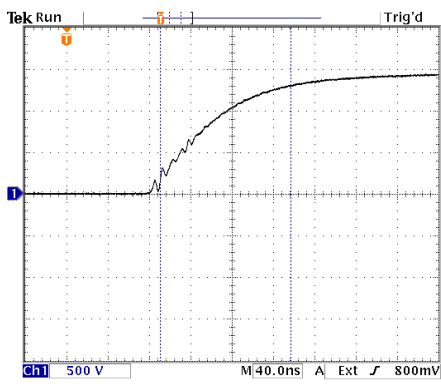

$C = 600 \text{ pF}$, $t_{R10-90} = 126.3 \text{ ns}$

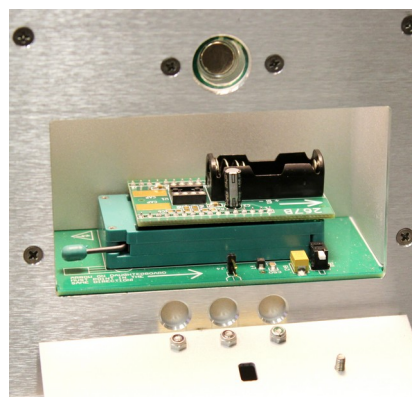

Positive positioning
of daughterboard

TYPICAL NEGATIVE RESULTS, WITH NO DUT INSTALLED

The photos below show typical “HV PULSE” waveforms with with AMP1 = -1.5 kV, and a daughterboard installed in the ZIF socket in the negative position (silkscreen arrows pointing same direction, daughterboard is as far as possible from the ZIF lever), but with no DUT installed in the DIP8 socket on the daughterboard:

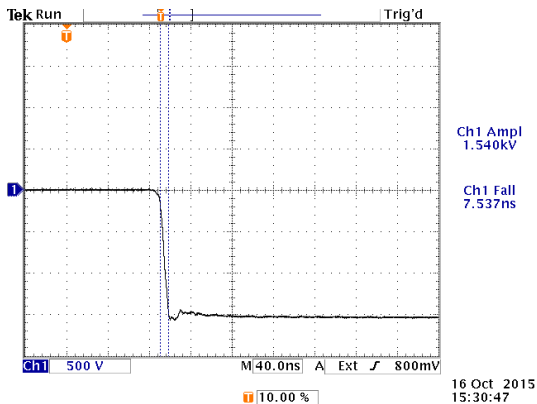

$C = 0 \text{ pF}$, $t_{R10-90} = 7.537 \text{ ns}$

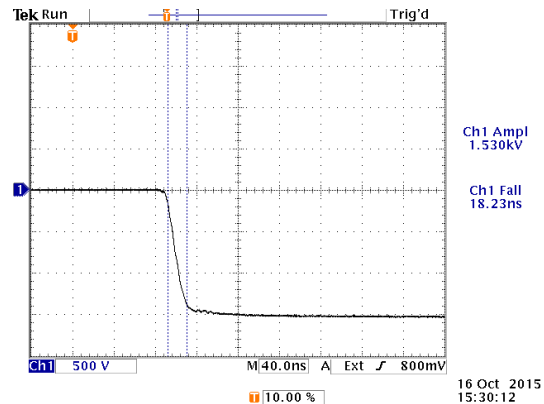

$C = 75 \text{ pF}$, $t_{R10-90} = 18.23 \text{ ns}$

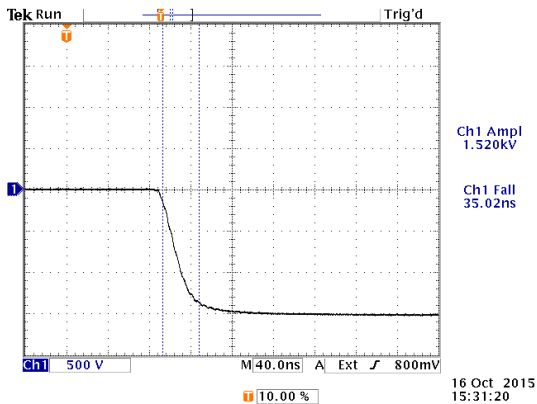

$C = 150 \text{ pF}$, $t_{R10-90} = 35.02 \text{ ns}$

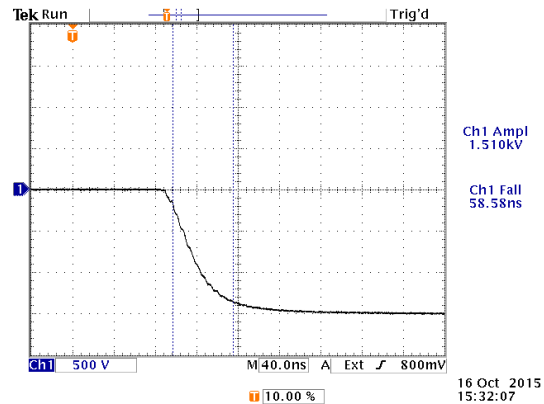

$C = 300 \text{ pF}$, $t_{R10-90} = 58.58 \text{ ns}$

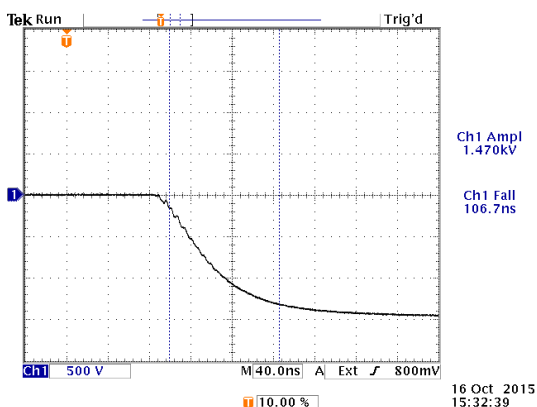

$C = 600 \text{ pF}$, $t_{R10-90} = 106.7 \text{ ns}$

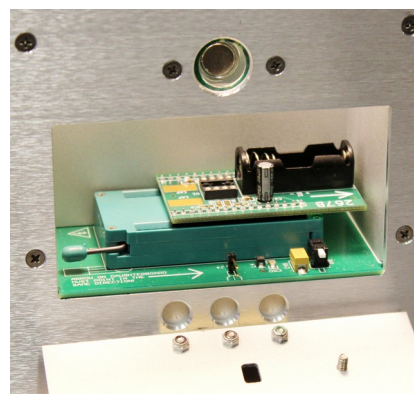

Negative positioning of daughterboard

VO3120 RESULTS

A Vishay VO3120 was tested using VCC2 = +32V, and the following daughterboard configuration:

Reference	Value	Typical Function
C6	Not used	Load capacitance
R1	Not used	Zero-Ohm Jumper to connect DUT pin 1 to VCC1
R2	Not used	Output pullup
R3	348 Ω for 10 mA tests, not used for 0 mA tests.	Resistance to connect DUT pin 2 to VCC1. Non-zero resistance for current-drive inputs.
R4	0 Ω	Zero-Ohm Jumper for DUT pin 7 as logic output
R5	Not used	Resistance to connect DUT pin 3 to VCC1
R6	0 Ω	Zero-Ohm Jumper for DUT pin 6 as logic output
R7	Not used	Resistance to connect DUT pin 4 to VCC1
R8	0 Ω	Zero-Ohm Jumper to connect DUT pin 1 to GND1
R9	Not used for 10 mA tests, 0 Ω for 0 mA tests.	Zero-Ohm Jumper to connect DUT pin 2 to GND1
R10	0 Ω	Zero-Ohm Jumper to connect DUT pin 3 to GND1
R11	0 Ω	Zero-Ohm Jumper to connect DUT pin 4 to GND1
P1, P2	Not used	No rise-time capacitance added between the CAP pads
BT1	One A23-type 12V battery for 10 mA tests, not used for 0 mA tests.	One user-installed A23-type 12V battery, prime power for VCC1. (Please note that A23 batteries have a limited mA-hr rating – typically 30 mA-hr when operating at 15 mA – so the battery should be removed immediately after testing, and its output should verified to be between 6V and 12V before each test.)

With the daughterboard installed in the ZIF socket in the positive position (silkscreen arrows pointing same direction, daughterboard is as close as possible to the ZIF lever), and AMP1 set to +1.5 kV and AMP2 set to +32V, these waveforms were obtained:

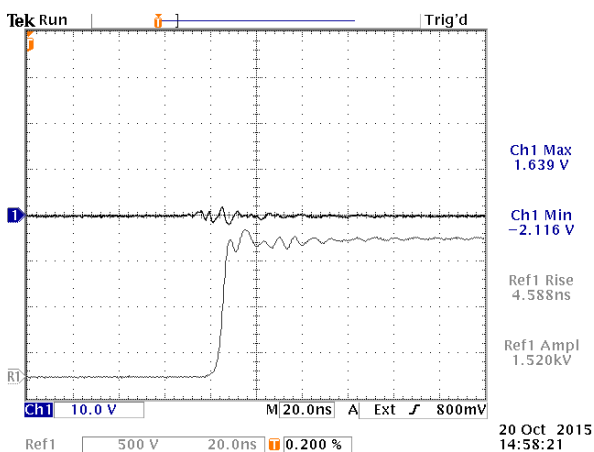

No significant logic output glitch for t_{R10-90} = 4.588 ns, so the CMTI exceeds $1.5 \text{ kV} \times (90\%-10\%) / 4.588 \text{ ns} = 261 \text{ kV/us}$ when $I_F = 0 \text{ mA}$.

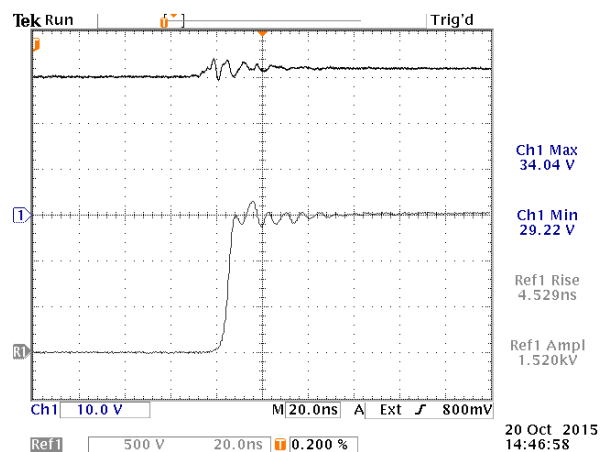

No significant logic output glitch for t_{R10-90} = 4.529 ns, so the CMTI exceeds $1.5 \text{ kV} \times (90\%-10\%) / 4.529 \text{ ns} = 265 \text{ kV/us}$ when $I_F = 10 \text{ mA}$.

The actual daughterboard and DUT are shown below, configured for 10 mA of input bias current (with $R3 = 348$ Ohms and the A23 battery installed):

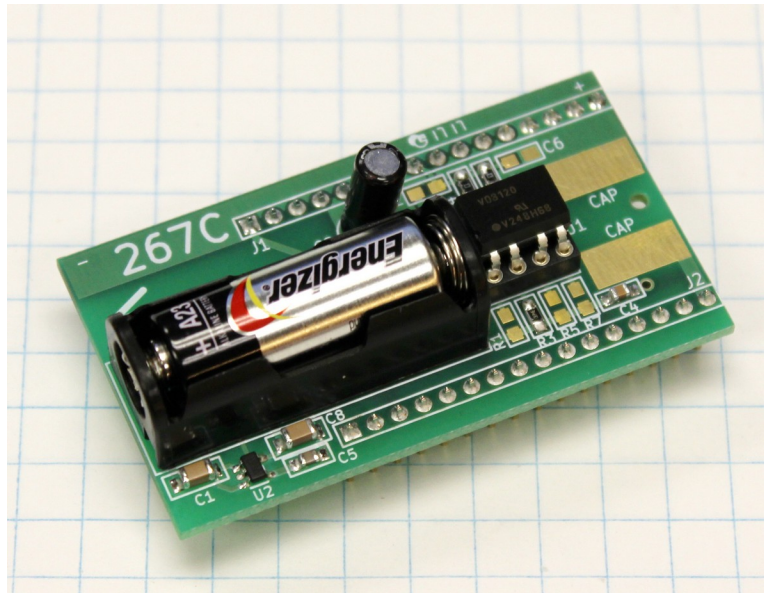

Top side

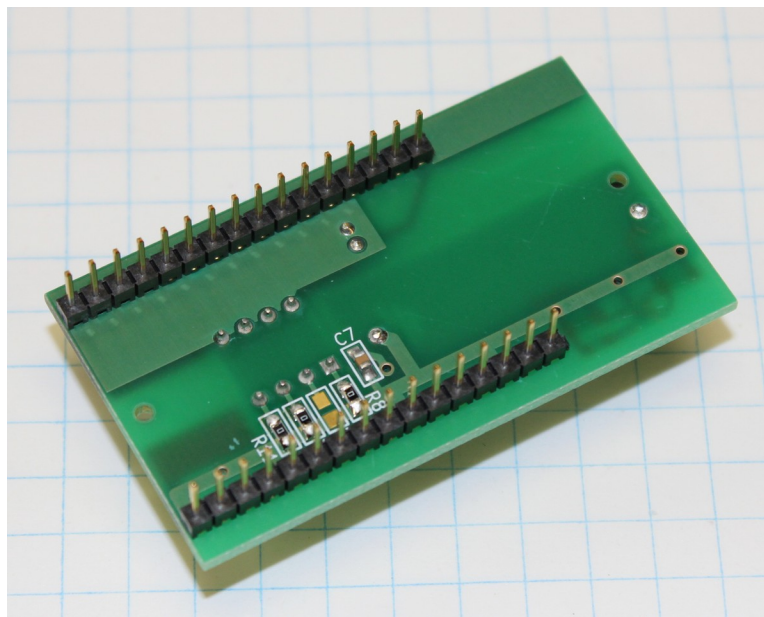

Bottom side

With the daughterboard installed in the ZIF socket in the negative position (silkscreen arrows pointing same direction, daughterboard is as far as possible from the ZIF lever), and AMP1 set to -1.5 kV and AMP2 set to $+32$ V, these waveforms were obtained:

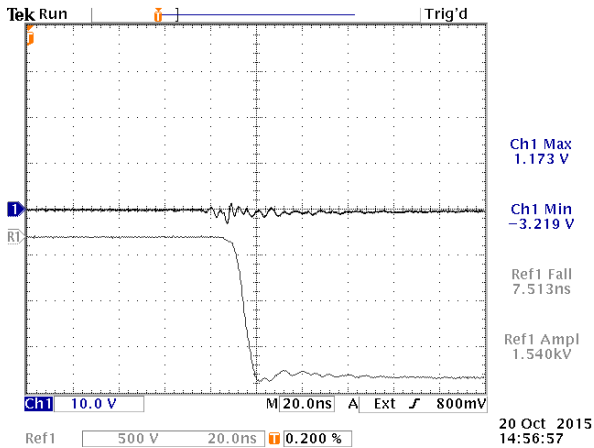

No significant logic output glitch for t_{R10-90} = 7.513 ns, so the CMTI exceeds $1.5 \text{ kV} \times (90\%-10\%) / 7.513 \text{ ns} = 160 \text{ kV/us}$ when $I_F = 0 \text{ mA}$.

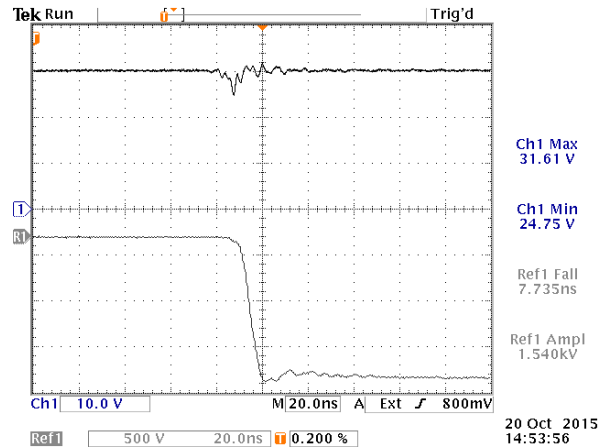

No significant logic output glitch for t_{R10-90} = 4.588 ns, so the CMTI exceeds $1.5 \text{ kV} \times (90\%-10\%) / 7.735 \text{ ns} = 155 \text{ kV/us}$ when $I_F = 10 \text{ mA}$.

These results show that the VO3120 has very high CMTI tolerance.

The positive high-voltage transition is slightly faster than the negative one (4.5 ns versus 7.5 ns), but both exceed the specified transition time of < 10 ns.

HCPL-7721 RESULTS

The HP / Agilent / Avago HCPL-7721 is a slower, older device. It was tested using VCC2 = +5V, and the following daughterboard configuration (including a rise time degradation capacitance):

Reference	Value	Typical Function
C6	Not used	Load capacitance
R1	0 Ω	Zero-Ohm Jumper to connect DUT pin 1 to VCC1
R2	Not used	Output pullup
R3	0 Ω for +5V input tests, not used for 0V input tests.	Resistance to connect DUT pin 2 to VCC1. Non-zero resistance for current-drive inputs.
R4	Not used	Zero-Ohm Jumper for DUT pin 7 as logic output
R5	Not used	Resistance to connect DUT pin 3 to VCC1
R6	0 Ω	Zero-Ohm Jumper for DUT pin 6 as logic output
R7	Not used	Resistance to connect DUT pin 4 to VCC1
R8	Not used	Zero-Ohm Jumper to connect DUT pin 1 to GND1
R9	Not used for +5V input tests, 0 Ω for 0V input tests.	Zero-Ohm Jumper to connect DUT pin 2 to GND1
R10	Not used	Zero-Ohm Jumper to connect DUT pin 3 to GND1
R11	0 Ω	Zero-Ohm Jumper to connect DUT pin 4 to GND1
P1, P2	150 pF	No rise-time capacitance added between the CAP pads
BT1	One A23-type 12V battery	One user-installed A23-type 12V battery, prime power for VCC1. (Please note that A23 batteries have a limited mA·hr rating – typically 30 mA·hr when operating at 15 mA – so the battery should be removed immediately after testing, and its output should verified to be between 6V and 12V before each test.)

With the daughterboard installed in the ZIF socket in the positive position (silkscreen arrows pointing same direction, daughterboard is as close as possible to the ZIF lever), and AMP1 set to +1.5 kV and AMP2 set to +5V, these waveforms were obtained:

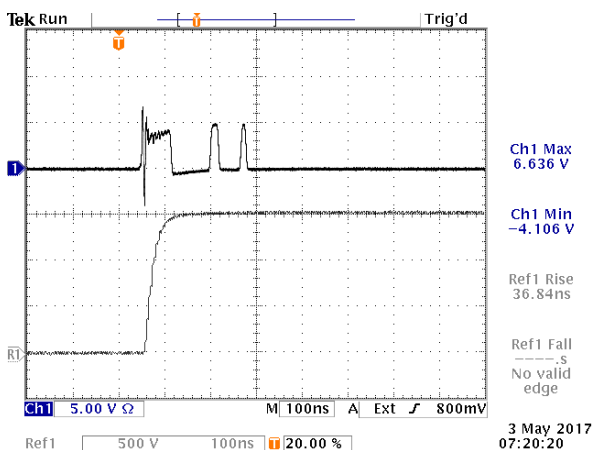

Top = Logic output for 0V input
Bottom = high voltage pulse

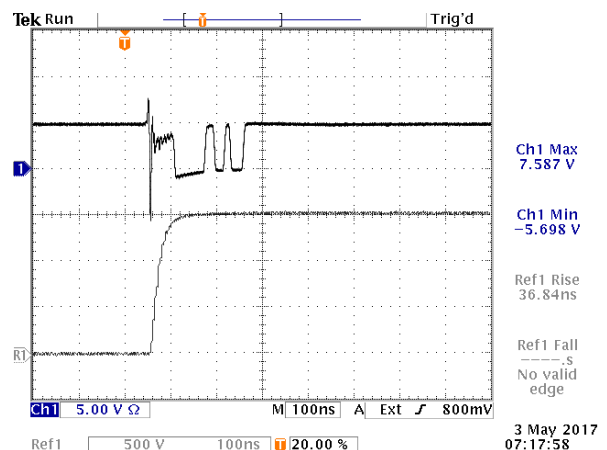

Top = Logic output for 5V input
Bottom = high voltage pulse

With the daughterboard installed in the ZIF socket in the negative position (silkscreen arrows pointing same direction, daughterboard is as far as possible from the ZIF lever), and AMP1 set to -1.5 kV and AMP2 set to +5V, these waveforms were obtained:

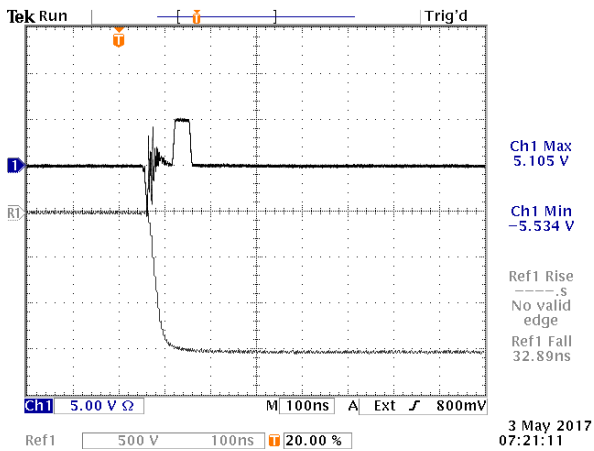

Top = Logic output for 0V input
Bottom = high voltage pulse

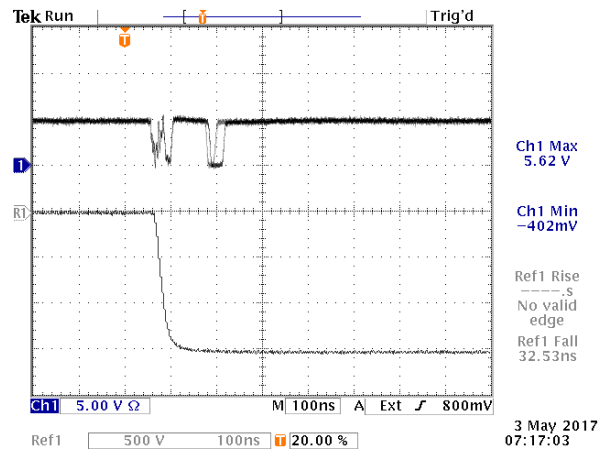

Top = Logic output for 5V input
Bottom = high voltage pulse

These results show that the HCPL-7721 has a much lower CMTI tolerance than the VO3120.

The actual daughterboard and DUT are shown below, configured for a 5V logic input:

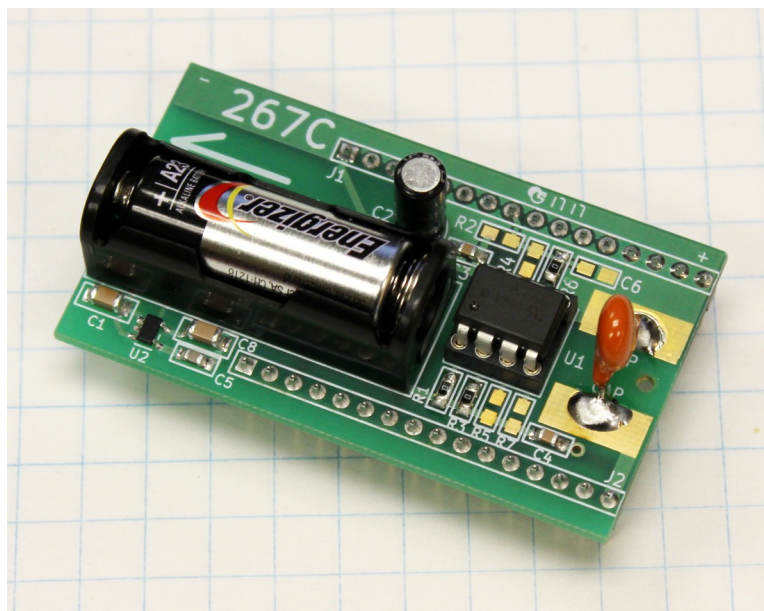

Top side

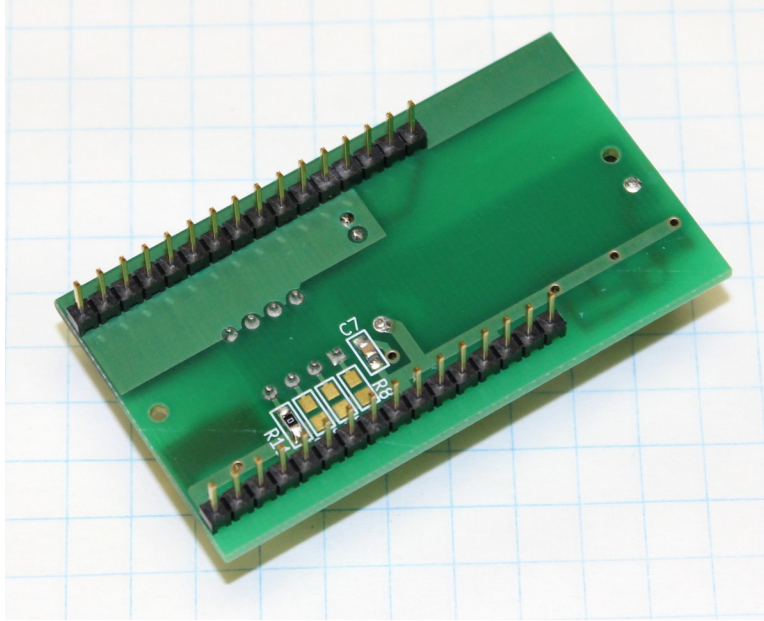

Bottom side

PCB 298B is similar to the standard sample daughterboard, except that it provides a footprint for a Toshiba TLP2366 in a 5-lead “SO6” SMT package. The DUT must be soldered to the daughterboard. (A DUT socket is not practical for these tests, since the extra parasitic capacitance introduced by a socket would severely degrade the measured CMTI.)

Installation is similar to the standard daughterboards. For positive pulse mode, the “AMP1” front-panel setting must be set to a positive value *AND* the daughterboard must be installed in the socket so that it is in the left-most position (when viewed from the DUT area door opening), closest to the socket lever.

For negative pulse mode, the “AMP1” front-panel setting must be set to a negative value *AND* the daughterboard must be installed in the socket so that it is in the right-most position (when viewed from the DUT area door opening), farthest from the socket lever.

No configuration resistors are installed on this daughterboard by default, to provide maximum flexibility for the user. Some resistors must be installed before they can be used for test purposes.

Typically, R6 = 0 (to connect the DUT pin 5 to the logic output connector), and either R8=0 (for 0 mA bias) or R1 = 560Ω (for 6 mA of bias).

To obtain the sample waveforms below, a Toshiba TLP2366 was tested using VCC2 = +5V, and the following daughterboard configuration (including a rise time degradation capacitance):

Reference	Value	Typical Function
C6	Not used	Load capacitance
R1	Not used for 0 mA tests, 560 Ω for 6 mA tests.	Resistance to connect DUT pin 1 to VCC1. Non-zero resistance for current-drive inputs.
R2	Not used	Output pullup
R6	0 Ω	Zero-Ohm Jumper for DUT pin 6 as logic output
R8	Not used for 6 mA tests, 0 Ω for 0 mA tests.	Zero-Ohm Jumper to connect DUT pin 1 to GND1
P1, P2	150 pF	Rise-time capacitance added between the CAP pads
BT1	One A23-type 12V battery	One user-installed A23-type 12V battery, prime power for VCC1. (Please note that A23 batteries have a limited mA·hr rating – typically 30 mA·hr when operating at 15 mA – so the battery should be removed immediately after testing, and its output should be verified to be between 6V and 12V before each test.)

With the daughterboard installed in the ZIF socket in the positive position (silkscreen arrows pointing same direction, daughterboard is as close as possible to the ZIF lever), and AMP1 set to +1.5 kV and AMP2 set to +5V, these waveforms were obtained:

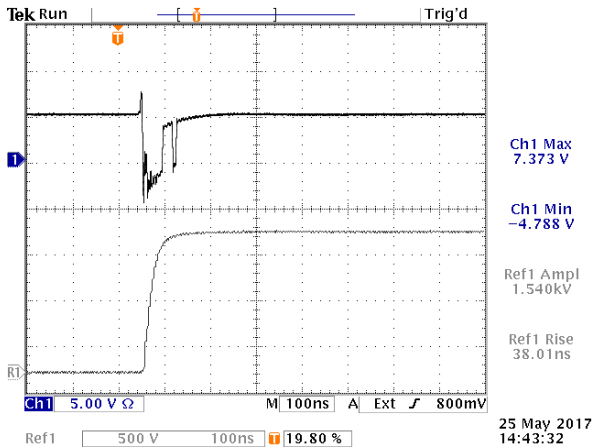

Top = Logic output for 0 mA input
Bottom = high voltage pulse

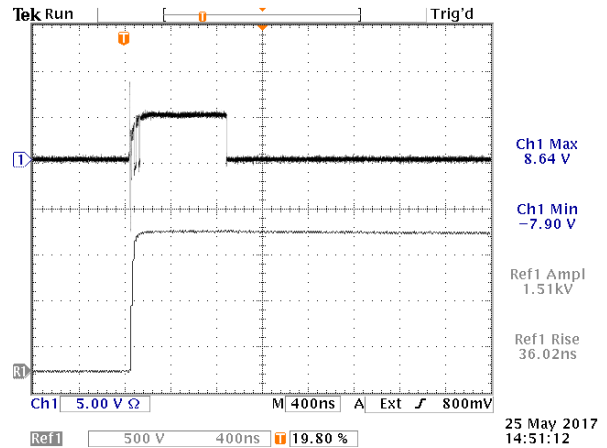

Top = Logic output for 6 mA input
Bottom = high voltage pulse

With the daughterboard installed in the ZIF socket in the negative position (silkscreen arrows pointing same direction, daughterboard is as far as possible from the ZIF lever), and AMP1 set to -1.5 kV and AMP2 set to +5V, these waveforms were obtained:

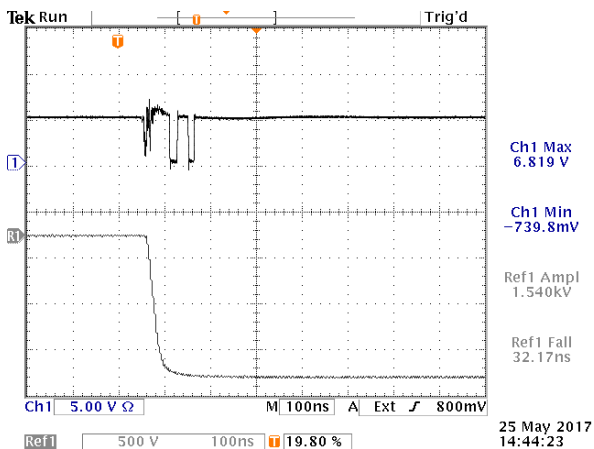

Top = Logic output for 0 mA input
Bottom = high voltage pulse

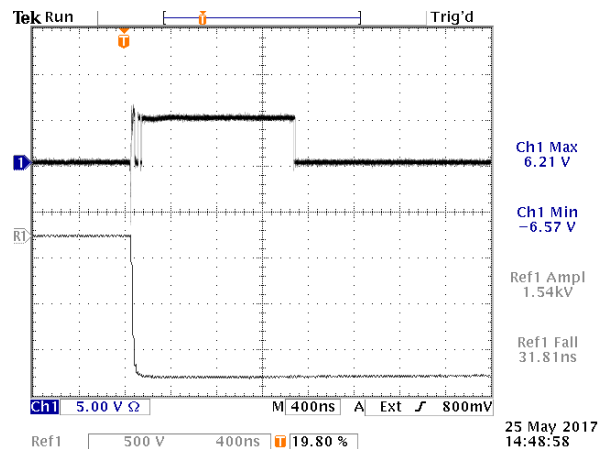

Top = Logic output for 6 mA input
Bottom = high voltage pulse

Particularly long output transients (a few microseconds in duration) are noted when the input is biased with 6 mA.

The actual daughterboard and DUT are shown below, configured for a 0 mA logic input:

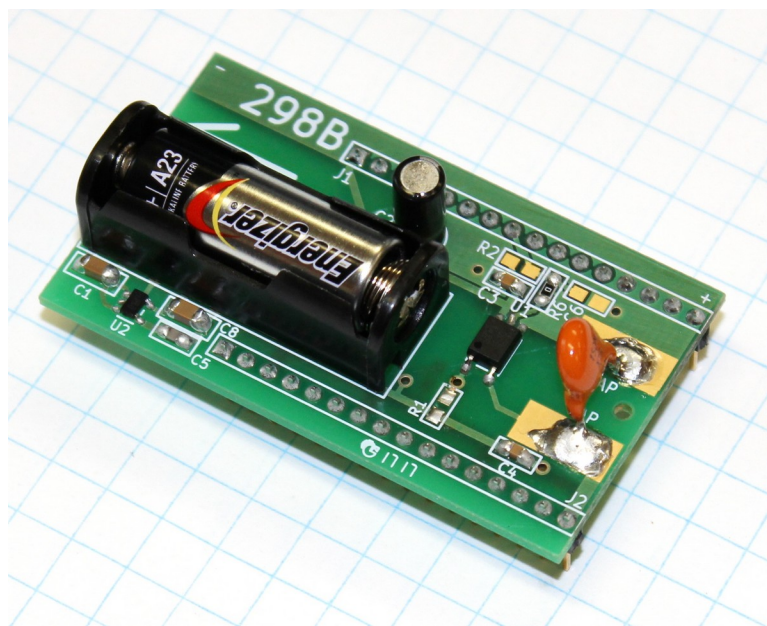

Top side

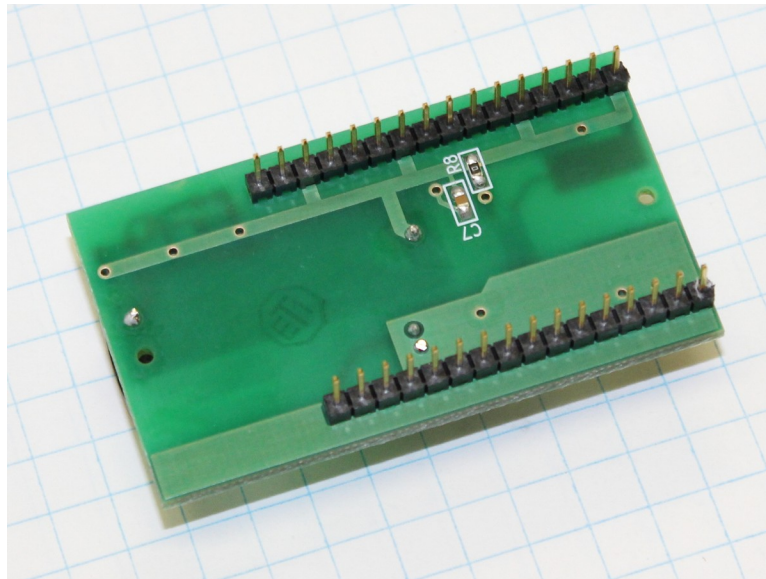

Bottom side

A P6246 differential probe was used to observe the logic outputs in the TLP2366 tests.

PCB 299B (FOR ADUM241E0BRWZ)

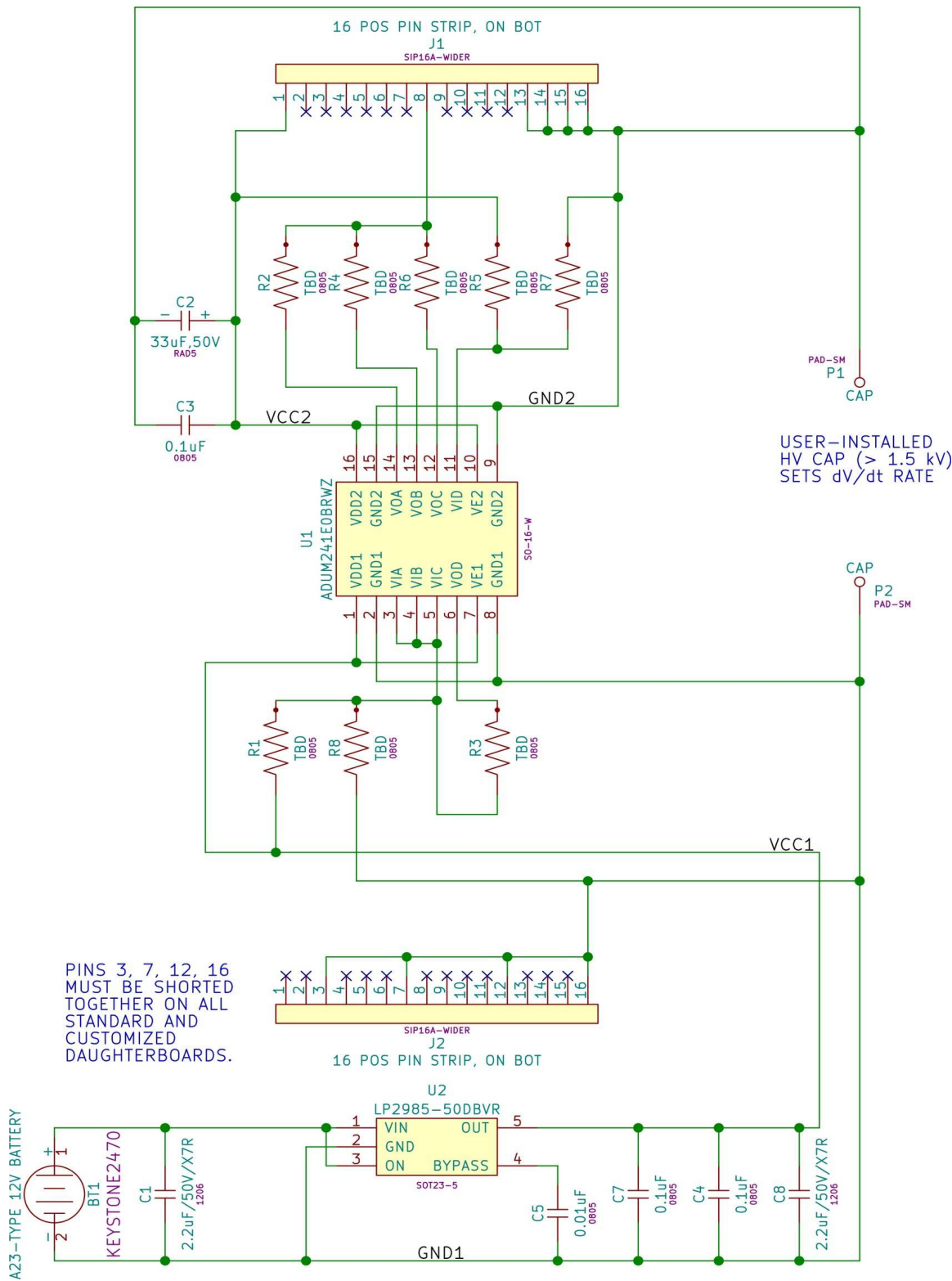

PCB 299B is similar to the standard sample daughterboard, except that it provides a footprint for an Analog Devices ADUM241E0BRWZ in a wide SO-16 SMT package. The DUT must be soldered to the daughterboard. (A DUT socket is not practical for these tests, since the extra parasitic capacitance introduced by a socket would severely degrade the measured CMTI.)

Installation is similar to the standard daughterboards. For positive pulse mode, the “AMP1” front-panel setting must be set to a positive value *AND* the daughterboard must be installed in the socket so that it is in the left-most position (when viewed from the DUT area door opening), closest to the socket lever.

For negative pulse mode, the “AMP1” front-panel setting must be set to a negative value *AND* the daughterboard must be installed in the socket so that it is in the right-most position (when viewed from the DUT area door opening), farthest from the socket lever.

No configuration resistors are installed on this daughterboard by default, to provide maximum flexibility for the user. Some resistors must be installed before they can be used for test purposes.

To obtain the sample waveforms below, an Analog Devices ADUM241E0BRWZ was tested using VCC2 = +5V, and the following daughterboard configuration (including a rise time degradation capacitance):

Reference	Value	Typical Function
R1	0 Ω for +5V input tests, not used for 0V input tests.	Zero-Ohm Jumper to connect VIA/VIB/VIC to VCC1
R2	Not used	Zero-Ohm Jumper for VOA as logic output
R3	Not used	Connects VOD to VIA/VIB/VIC, for bidirectional testing
R4	Not used	Zero-Ohm Jumper for VOB as logic output
R5	Not used	Zero-Ohm Jumper for VCC2 to VID
R6	0 Ω	Zero-Ohm Jumper for VOC as logic output
R7	0 Ω	Zero-Ohm Jumper for GND2 to VID
R8	0 Ω for 0V input tests, not used for +5V input tests.	Zero-Ohm Jumper to connect VIA/VIB/VIC to GND1
P1, P2	150 pF	Rise-time capacitance added between the CAP pads
BT1	One A23-type 12V battery	One user-installed A23-type 12V battery, prime power for VCC1. (Please note that A23 batteries have a limited mA·hr rating – typically 30 mA·hr when operating at 15 mA – so the battery should be removed immediately after testing, and its output should be verified to be between 6V and 12V before each test.)

With the daughterboard installed in the ZIF socket in the positive position (silkscreen arrows pointing same direction, daughterboard is as close as possible to the ZIF lever), and AMP1 set to +1.5 kV and AMP2 set to +5V, these waveforms were obtained:

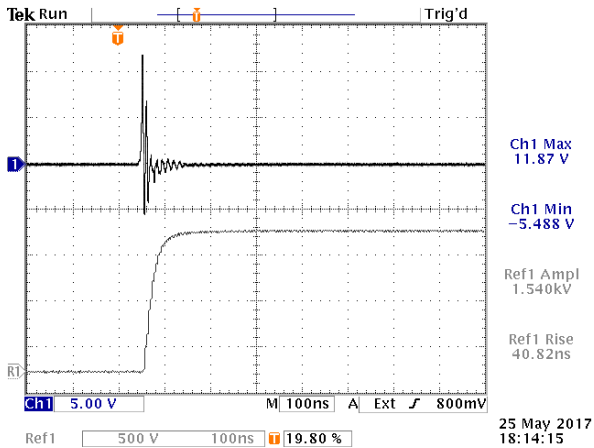

Top = Logic output for 0V input
Bottom = high voltage pulse

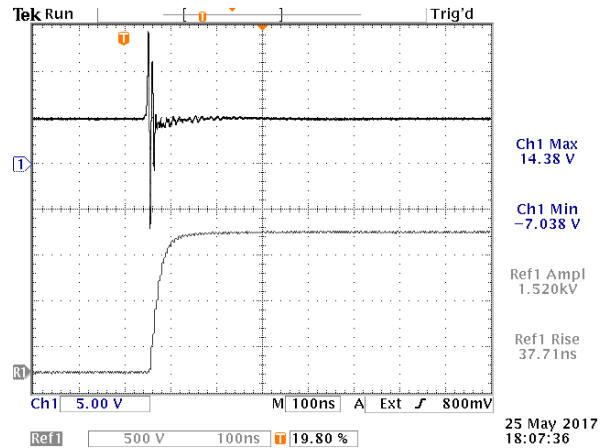

Top = Logic output for +5V input
Bottom = high voltage pulse

With the daughterboard installed in the ZIF socket in the negative position (silkscreen arrows pointing same direction, daughterboard is as far as possible from the ZIF lever), and AMP1 set to -1.5 kV and AMP2 set to +5V, these waveforms were obtained:

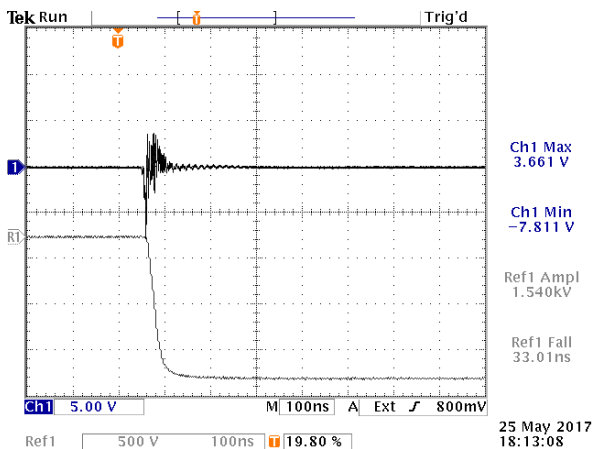

Top = Logic output for 0V input
Bottom = high voltage pulse

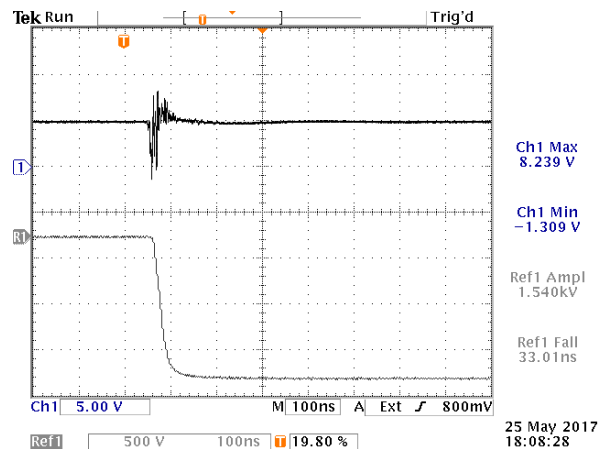

Top = Logic output for +5V input
Bottom = high voltage pulse

The actual daughterboard and DUT are shown below, configured for a 0V logic input:

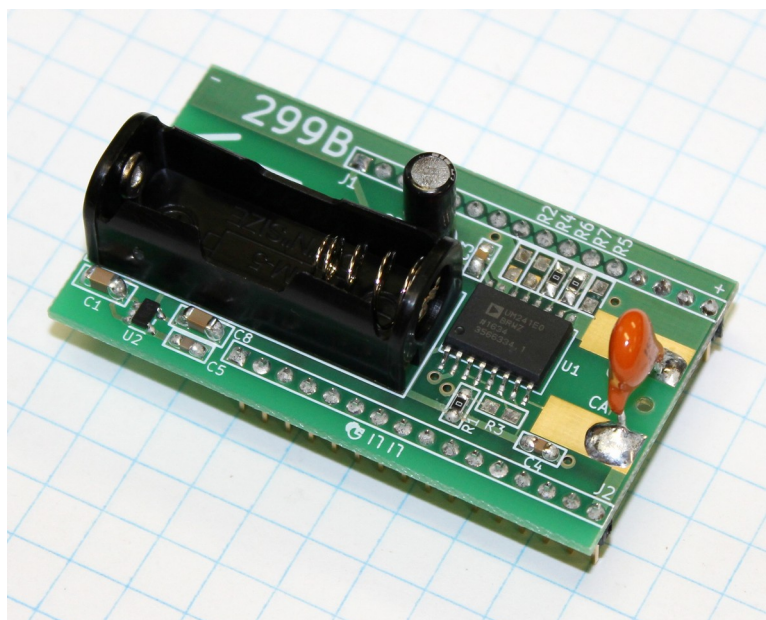

Top side

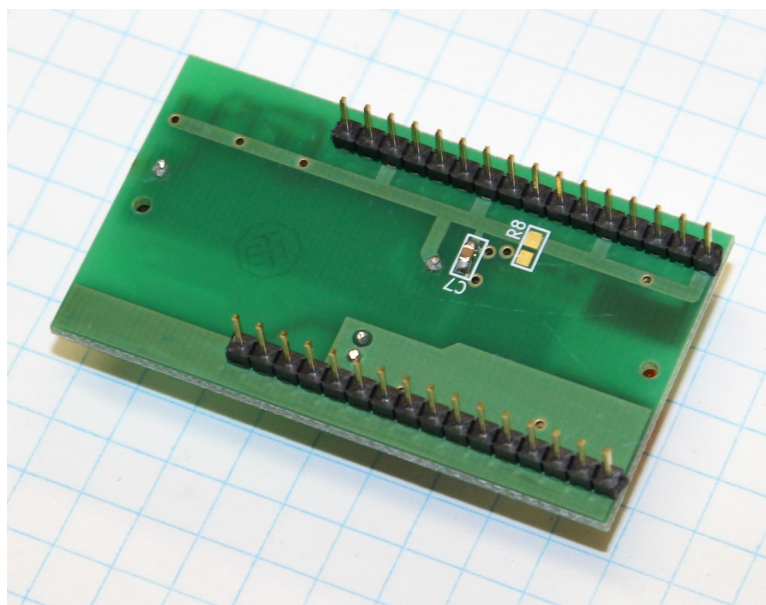

Bottom side

A P6139A non-differential probe was used to observe the logic outputs in the TLP2366 tests, because the observed transients substantially exceeded the $\pm 7\text{V}$ range of the P6246 differential probe.

CAPACITIVE INTERFERENCE ISSUES

The AVRQ-5-B requires the user to observe a logic-level output signal (typically 5V in amplitude) in the presence of a 1500 V pulse. This creates ample potential for interference, which can make it difficult to separate real glitches from measurement artifacts. This section aims to explain the issues.

When there is no capacitive loading on the output, the AVRQ-4-B can typically exhibit switching times as fast as 4 ns (10%-90%) for 1500V pulse. If the optocoupler DUT is an open-collector type with a 1 kilohm pull-up resistance, then a capacitively-coupled current of 5 mA will be sufficient to cause a 5V spike on the optocoupler output (since $5\text{mA} \times 1\text{k}\Omega = 5\text{V}$). The parasitic capacitance necessary for this to occur may be calculated from:

$$I = C \, dV/dt$$

$$C = I \, dt / dV$$

$$C = 5\text{mA} \times 4 \, \text{ns} / (1500\text{V} \times (90\% - 10\%))$$

$$C = 0.0167 \, \text{pF}$$

This is an extremely small capacitance, that can easily occur through parasitic effects on the daughterboard and external cabling.

Similar effects can occur in the oscilloscope and its probes, through inter-channel interference.

The worst-case scenario occurs when there is no DUT installed on the daughterboard, so the logic output is simply floating. The impedance level is very high, so any capacitively coupled current will generate a substantial voltage. The images below demonstrate this:

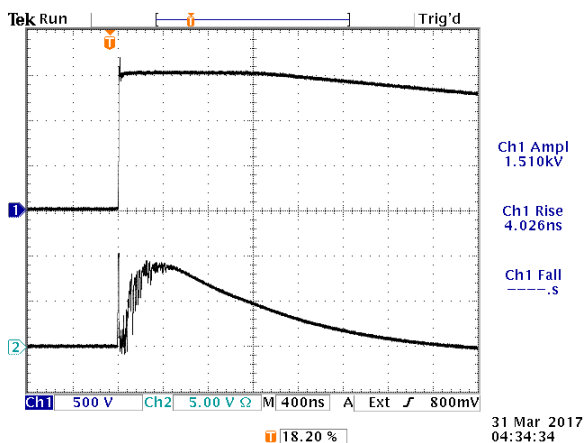

*Top: +1.5 kV HV pulse
Bottom: Logic out into open circuit
no DUT, 400 ns/div*

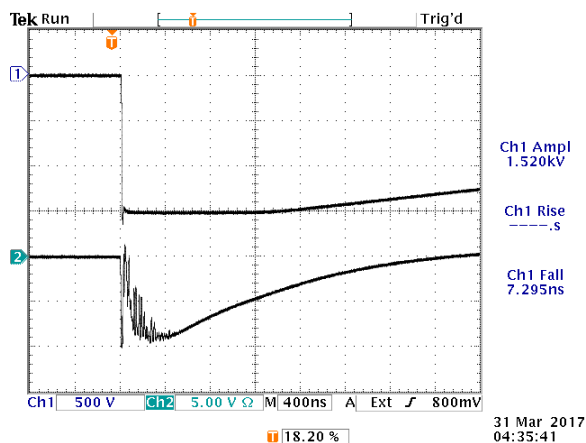

*Top: -1.5 kV HV pulse
Bottom: Logic out into open circuit
no DUT, 400 ns/div*

A very large spurious signal is observed on the logic output! If the impedance of the logic output is reduced by adding a 1 kilohm pull-up resistor (R2 on the sample daughterboards) to VCC2 = +5V, a smaller transient of shorter duration is observed:

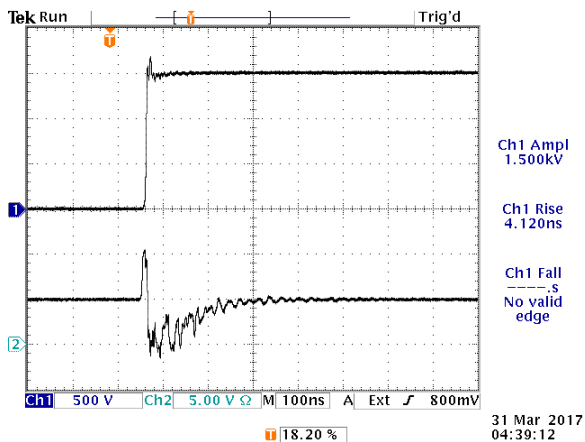

Top: +1.5 kV HV pulse
Bottom: Logic out into open circuit
no DUT, $R_2 = 1k\Omega$, 100 ns/div

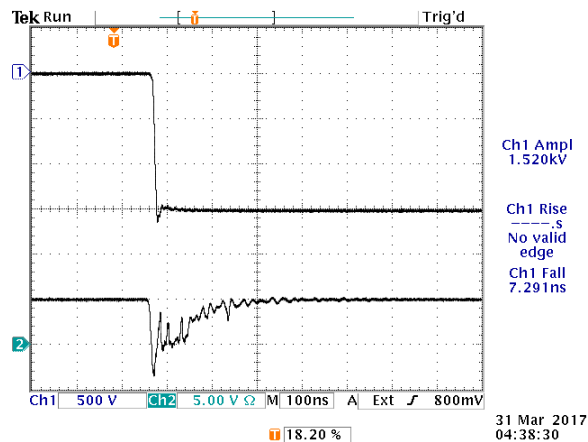

Top: -1.5 kV HV pulse
Bottom: Logic out into open circuit
no DUT, $R_2 = 1k\Omega$, 100 ns/div

In the above waveform photos, both channels of the oscilloscope are used simultaneously. To eliminate the possibility of oscilloscope inter-channel interference, it is better to record the HV pulse (typically using the oscilloscope "REF" storage function), then full disconnect the HV probe from the HV signal, and then observe the logic output. If this is done, the logic signal in last two images become much cleaner:

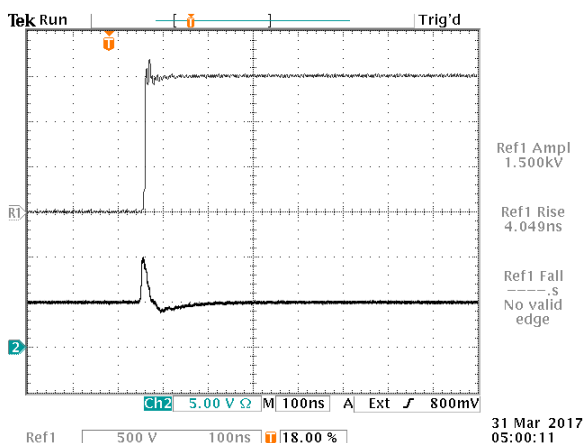

Top: +1.5 kV HV pulse
Bottom: Logic out into open circuit
no DUT, $R_2 = 1k\Omega$, 100 ns/div

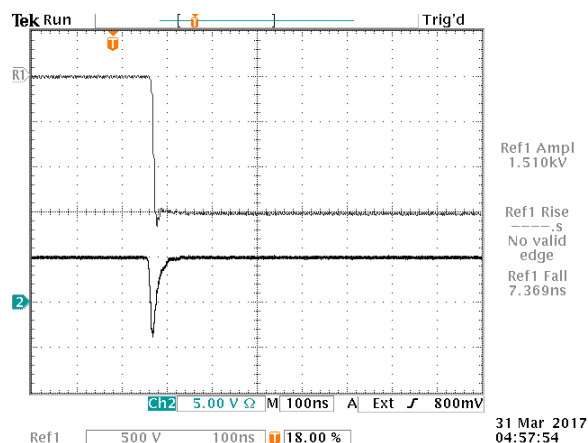

Top: -1.5 kV HV pulse
Bottom: Logic out into open circuit
no DUT, $R_2 = 1k\Omega$, 100 ns/div

It becomes clear that both effects (capacitive coupling on the daughterboard, and in the oscilloscope) are important. The oscilloscope portion is easily eliminated, at least.

The 1 kilohm impedance still results in a large voltage spike. If the pullup resistance is dramatically reduced to 50 Ohms, the coupled voltage spike is also reduced:

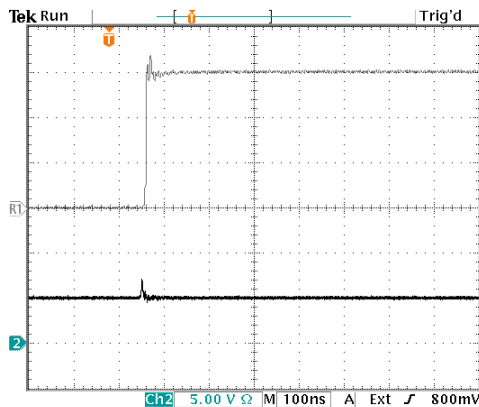

Top: +1.5 kV HV pulse
Bottom: Logic out into open circuit
no DUT, $R_2 = 1\text{k}\Omega$, 100 ns/div

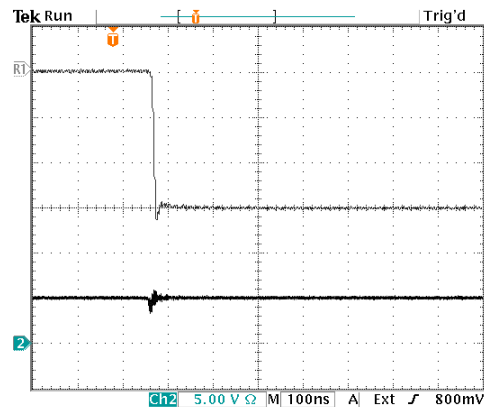

Top: -1.5 kV HV pulse
Bottom: Logic out into open circuit
no DUT, $R_2 = 1\text{k}\Omega$, 100 ns/div

This is not usually a practical circuit setup for a real DUT (since they are not normally capable of driving 50 Ohm impedances, unless they are gate drivers), but it lets us estimate the parasitic capacitance present on the daughterboard. A spike on the order of 2V is observed, giving:

$$I = C \, dV/dt$$

$$C = I \, dt / dV$$

$$C = (2\text{V} / 50 \text{ Ohms}) \times 4 \text{ ns} / (1500\text{V} \times (90\% - 10\%))$$

$$C = 0.13 \text{ pF}$$

This is a physically reasonable value for the parasitic capacitance between the high voltage pulse and output logic signal lines on the daughterboard.

The effects of capacitive coupling will be especially significant for devices with open-collector outputs when the outputs are passively pulled high through a resistance of a few kilohms or higher. For example, if an HCPL-2601 is tested using $R_2 = 1 \text{ k}\Omega$ (and $R_6 = R_9 = R_{10} = 0\Omega$), the logic outputs are quite similar to the results on the previous page (which used no DUT, and $R_2 = 1 \text{ k}\Omega$):

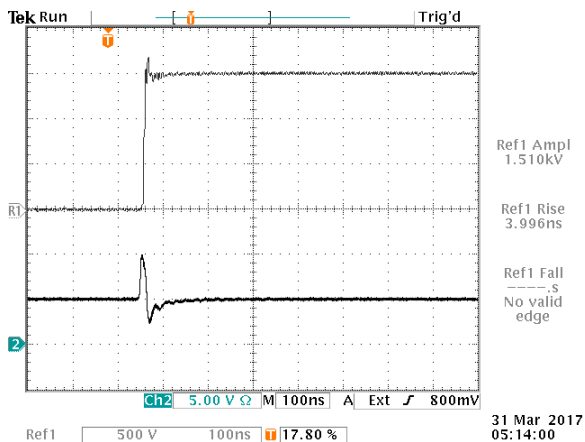

*Top: +1.5 kV HV pulse
 Bottom: Logic out into open circuit
 HCPL-2601, $R_2 = 1\text{k}\Omega$, $R_{6/9/10} = 0$,
 100 ns/div*

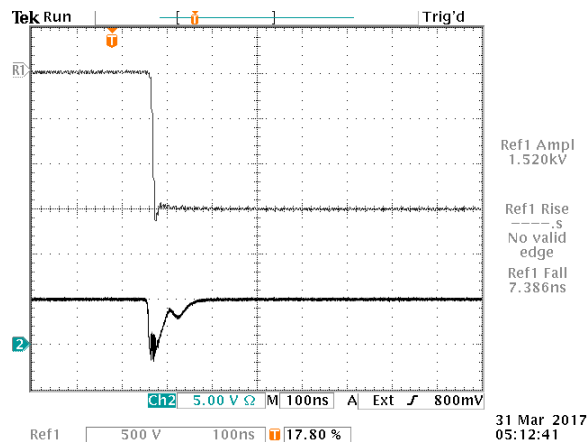

*Top: -1.5 kV HV pulse
 Bottom: Logic out into open circuit
 HCPL-2601, $R_2 = 1\text{k}\Omega$, $R_{6/9/10} = 0$,
 100 ns/div*

Unfortunately, this makes it difficult to determine which transients are due to glitches transmitted inside the DUT and which are due to external capacitive coupling. This is an unavoidable consequence of using an open-collector device. It will also be an issue for optocouplers with totem-pole output circuits, if the current drive ratings of these outputs are on the order of tens of milliamps or less – the capacitively-coupled current may still overwhelm the output transistor current.

Some optocouplers have output circuits intended for gate-drive applications. These ICs typically have very high output current ratings (or, equivalently, very low output impedances). For instance, the VO3120 can source or sink 2.5 Amps. As a result, they capacitively coupled signals are much smaller. For example, if an VO3120 is tested using $R_{4/6/9/10} = 0\Omega$, the following outputs are obtained:

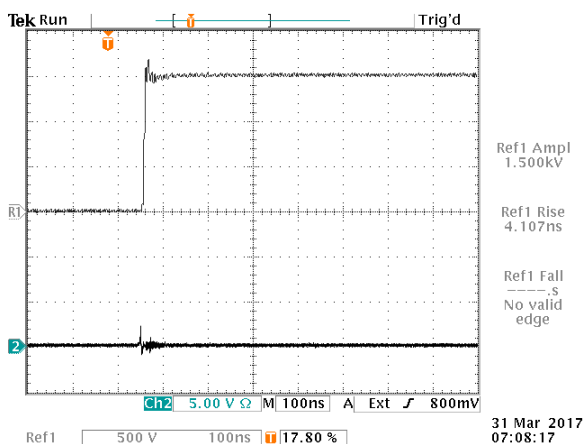

*Top: +1.5 kV HV pulse
 Bottom: Logic out into open circuit
 VO3120, $R_2 = \infty$, $R_{4/6/9/10} = 0$,
 100 ns/div*

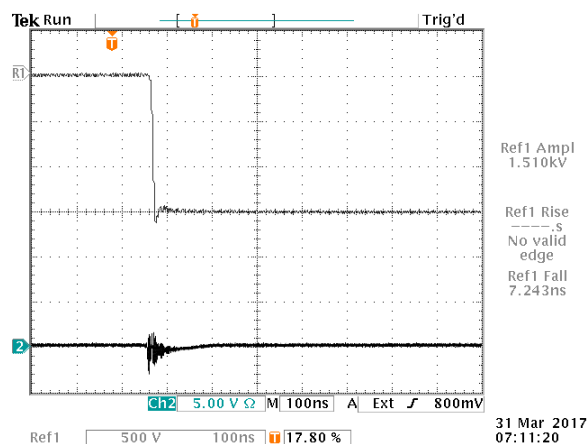

*Top: -1.5 kV HV pulse
 Bottom: Logic out into open circuit
 VO3120, $R_2 = \infty$, $R_{4/6/9/10} = 0$,
 100 ns/div*

Some decaying LC-type oscillations are observed, due to the parasitic inductance in the circuit interacting with the parasitic capacitance.

Similar results are obtained for the VO3120 when its input side is biased high rather than low:

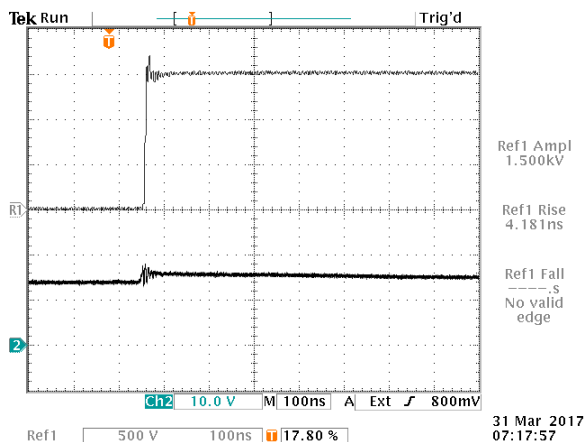

*Top: +1.5 kV HV pulse
Bottom: Logic out into open circuit
VO3120, $R_2 = \infty$, $R_3 = 348\Omega$,
 $R_4/6/10 = 0$, 100 ns/div*

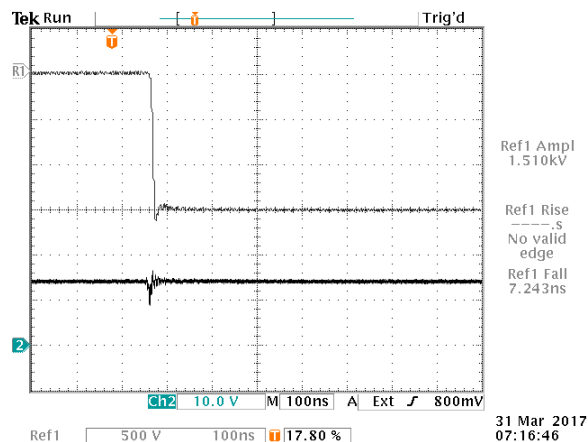

*Top: -1.5 kV HV pulse
Bottom: Logic out into open circuit
VO3120, $R_2 = \infty$, $R_3 = 348\Omega$,
 $R_4/6/10 = 0$, 100 ns/div*

(Note that a low-voltage differential logic probe can not be used for the above test, unless it is rated to handle a +15V signal.)

Some level of capacitive interference is unavoidable. Its magnitude depends on the design of the DUT output circuitry (especially its output impedance in both logic states).

INDUCTIVE SPIKES AND PROBE SATURATION

Some care must be taken if using a differential probe to sense the logic output. While a differential probe can be useful in reducing the possibility of interference from the high-voltage pulse, it may have strict voltage limits. For example, the Tektronix P6246 is only suitable for values of V_{CC2} up to +7V. A non-differential probe may be more suitable if $V_{CC2} > 7V$.

A less obvious problem arises if parasitic inductances or capacitances in the test circuit cause differential voltage spikes exceeding $\pm 7V$. The P6246 can saturate heavily under those conditions, which can generate apparent glitch-like transients that are not due to the DUT. Some experimentation may be required by the user in order to identify the best probing arrangement.

Early versions of the AVRQ-5-B were provided with sample daughterboards P/N 267B or earlier. (The current version is 267C). The earlier daughterboards used one pin to connect GND2 to the main board ZIF socket. The inductance in the socket pin was sufficient to generate a short voltage spike that could, under some circumstances, overload the P6246 probe. For example, with a 267B daughterboard, a 1k pullup resistor (R2), $V_{CC} = +5V$, 300 pF between P1 and P2, and no DUT, the following waveforms were obtained:

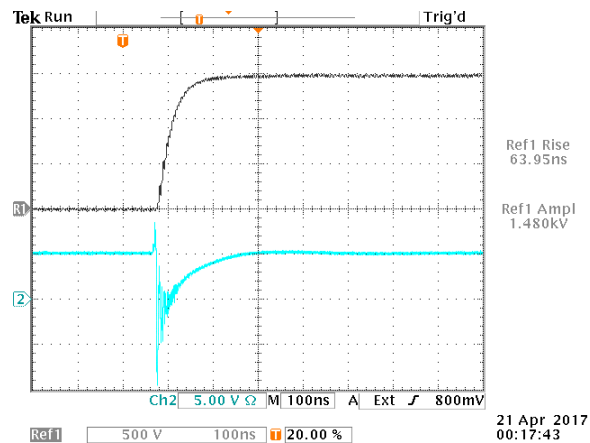

This shows an apparent 200 ns wide “glitch” on the logic output. In fact, the P6246 is saturating from the sharp initial inductive voltage spikes, and is taking 200 ns to recover.

To fix this issue, later daughterboards (267C and later) use four pins to connect GND2 to the main board ZIF socket. This reduces the initial inductive voltage spikes, and prevents probe saturation:

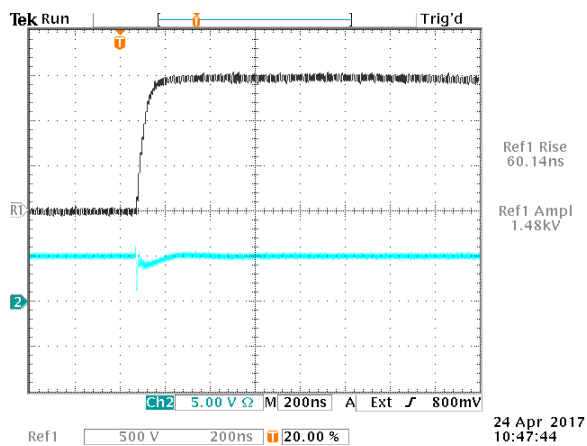

If you are experiencing “unexpected” transients, keep in mind this possibility of probe saturation.

(Users of AVRQ-5-B models with serial numbers below 13560 may wish to contact Avtech to have the additional pins of the ZIF socket wired for GND2 use, to reduce this effect.)

DC CORRECTNESS ISSUES

The sample daughterboards provided with the AVRQ-5-B are designed to bias the input side of the optocoupler with a fixed bias during the test. To change it, components must be physically changed. This can be problematic with certain devices that do not necessarily power-up to a well-defined state. The NVE IL710 is an example of such a device – as the IL710 datasheet says:

“To minimize power dissipation, input signals are differentiated and then latched on the output side of the isolation barrier to reconstruct the signal. This could result in an ambiguous output state depending on power up, shutdown and power loss sequencing. Therefore, the designer should consider including an initialization signal in the start-up circuit. Initialization consists of toggling the input either high then low, or low then high.”

The user may wish to add power-up toggle circuitry, or an oscillator, in order to correctly initialize and drive such devices.

VERIFICATION AND TROUBLESHOOTING

It is sometimes unclear whether the glitches observed on the opto-coupler output are due to the opto-coupler or the test circuit.

To reduce the number of sources of possible interference or error, a daughterboard scheme is used. This allows the drive conditions and the loading to be defined by simple, compact circuits that are user-visible and user-changeable.

Similarly, the floating-side power or bias is derived from a simple battery circuit, whose schematic is included in the schematics section of this manual. A more exotic switching non-battery-based power supply design has been avoided, to minimize complexity. The battery circuit is always active when a battery is installed, allowing current biases to be measured while the DUT is installed in the daughterboard, but the daughterboard is outside of the mainframe. For example, for current-drive devices with non-zero bias levels, the current can typically be measured using compact DMM probes across resistor R3.

 Please note that A23 batteries have a limited mA·hr rating – typically 30 mA·hr when operating at 15 mA – so the battery should be removed immediately after testing, and its output should be verified to be between 6V and 12V before each test.

The high-voltage circuits are only on when the instrument is powered on AND the DUT door is closed AND the output has been set to the “on” state.

 It is NOT possible to measure the drive current or voltage on the floating input side while the high voltage pulse is active. It is dangerous, and it does not work anyway.

 High-voltage differential probes DO NOT accurately reproduce signals if an extremely fast high-voltage common mode signal is present. In other words, their CMTI is worse than that of typical opto-couplers.

 Using two probes and performing oscilloscope-based mathematics to calculate a difference is NOT accurate enough to measure a ~1V differential signal in the presence of a ~ 1.5 kV common mode signal.

If there is doubt about the stability of a non-zero drive signal, try soldering large capacitances across the drive pins of the input to see if that stabilizes anything (taking care to keep the capacitances away from the non-floating circuitry, for safety and interference reasons). If there is no change, that would tend to eliminate the drive signal as a source of problems.

If there is doubt about the stability of a zero-level drive signal, try soldering together the two drive pins directly on the IC package (i.e., short them out), to see if that stabilizes

anything. If there is no change, that would tend to eliminate the drive signal as a source of problems.

Some devices are simply very sensitive to ANY stray capacitance between the input and output sides. Some devices are extremely sensitive to interference coupled to pin 7, which (unwisely) provides a connection to the photo-transistor base. To test this as a possible problem source, try snipping off pin 7 on your device and see if that affects the results beneficially. If it does, you might want to consider designing your own ultra-low-stray-capacitance socket and daughterboard, or avoiding sockets entirely and using soldered devices instead.

SAFETY CONCERNS

TURN OUTPUT OFF BEFORE ACCESSING DUT

Always turn the output off before opening the rear-panel DUT door, using the front panel menu or by computer command (“output off”).

If you do not disable the output first, the output will be automatically disabled by a sensor on the DUT door when it is opened. However, the user should not rely on this for safety purposes.

Always check that the front panel indicates that the output is “off” before touching the DUT area.

For maximum safety, turn off the instrument before accessing the DUT area. Ensure that the instrument has been turned off for at least 60 seconds before turning it back on, to allow the embedded controller to reset properly.

AUTOMATIC TIMEOUT

The output is disabled automatically after 90 seconds of inactivity. The timer resets each time a pulse parameter (amplitude, PRF, etc) is changed.

OVERLOAD INDICATOR

The front-panel “overload” indicator should always glow green, and never amber (except briefly when the instrument is first turned on).

If the overload indicator becomes active (amber), stop using the instrument immediately.

OPERATIONAL CHECK

This section describes a sequence to confirm the basic operation of the instrument. It should be performed after receiving the instrument. It is a useful learning exercise as well.

Before proceeding with this procedure, finish reading this instruction manual thoroughly. Then read the “Local Control” section of the “Programming Manual for -B Instruments” thoroughly. The “Local Control” section describes the front panel controls used in this operational check - in particular, the MOVE, CHANGE, and ADJUST controls.

1. With the power off, connect the pulser and the oscilloscope as described in the “Basic Test Arrangement” section on page 41. Install a daughterboard (with no DUT) in the ZIF socket in the positive position (silkscreen arrows pointing same direction, daughterboard is as close as possible to the ZIF lever).

 Confirm that the scope probe, test load, cables, and any adapters used are rated for 1.5 kV (2 kV for -XHV units) pulsed operation.

2. Turn on the AVRQ-5-B. The main menu will appear on the LCD.
3. To set the AVRQ-5-B to trigger from the internal clock at a PRF of 10 Hz:
 - a) The arrow pointer should be pointing at the frequency menu item. If it is not, press the MOVE button until it is.
 - b) Press the CHANGE button. The frequency submenu will appear. Rotate the ADJUST knob until the frequency is set at 10 Hz.
 - c) The arrow pointer should be pointing at the “Internal” choice. If it is not, press MOVE until it is.
 - d) Press CHANGE to return to the main menu.
4. To set the delay to 50 ns:
 - a) Press the MOVE button until the arrow pointer is pointing at the delay menu item.
 - b) Press the CHANGE button. The delay submenu will appear. Rotate the ADJUST knob until the delay is set at 50 ns.
 - c) The arrow pointer should be pointing at the “Normal” choice. If it is not, press MOVE until it is.

- d) Press CHANGE to return to the main menu.
5. To set the HV PULSE amplitude to +1.5 kV:
 - a) Press the MOVE button until the arrow pointer is pointing at the AMP1 menu item.
 - b) Press the CHANGE button. The submenu will appear. Rotate the ADJUST knob until the amplitude is set at +1.5 kV.
 - c) Press CHANGE to return to the main menu.
 6. To set the VCC2 amplitude to +5V:
 - a) Press the MOVE button until the arrow pointer is pointing at the AMP2 menu item.
 - b) Press the CHANGE button. The submenu will appear. Rotate the ADJUST knob until the amplitude is set at +5V.
 - c) Press CHANGE to return to the main menu.
 7. At this point, nothing should appear on the oscilloscope.
 8. To enable the output:
 - a) Press the MOVE button until the arrow pointer is pointing at the output menu item.
 - b) Press the CHANGE button. The output submenu will appear.
 - c) Press MOVE until the arrow pointer is pointing at the “ON” choice.
 - d) Observe the oscilloscope. You should see +1.5 kV pulses with < 10 ns rise time, approximately.
 - e) Press CHANGE to return to the main menu.
 9. 90 seconds after the last parameter change, the instrument will automatically shut the output off. Confirm that this occurs.

This completes the operational check.

PROTECTING YOUR INSTRUMENT

USE HIGH-VOLTAGE CABLES, CONNECTORS, AND PROBES

 Confirm that the scope probe and any adapters used on the HV PULSE output are rated for at least 1.5 kV (2 kV for -XHV units) pulsed operation.

SHORT-CIRCUIT PROTECTION

The output will withstand temporary short-circuit conditions. However, short-circuit conditions should not be allowed to persist longer than 10 seconds, or the stress on the components will shorten the circuit lifetime.

MECHANICAL INFORMATION

TOP COVER REMOVAL

If necessary, the interior of the instrument may be accessed by removing the four Phillips screws on the top panel. With the four screws removed, the top cover may be slid back (and off).

 Always disconnect the power cord and allow the instrument to sit unpowered for 10 minutes before opening the instrument. This will allow any internal stored charge to discharge.

There are no user-adjustable internal circuits. For repairs other than fuse replacement, please contact Avtech (info@avtechpulse.com) to arrange for the instrument to be returned to the factory for repair.

 Caution: High voltages (over 2000V) are present inside the instrument during normal operation. Do not operate the instrument with the cover removed.

 Caution: Do not remove the internal aluminum lid. It shields certain very-high-voltage areas.

RACK MOUNTING

A rack mounting kit is available. The -R6 rack mount kit may be installed after first removing the one Phillips screw on the side panel adjacent to the front handle.

MAINTENANCE

REGULAR MAINTENANCE

This instrument does not require any regular maintenance. Traceable calibration of the pulse parameters should be established using a calibrated measurement of the output, rather than relying on instrument settings.

On occasion, one or more of the four rear-panel fuses may require replacement. All fuses can be accessed from the rear panel. See the “FUSES” section for details.

CLEANING

If desired, the interior of the instrument may be cleaned using compressed air to dislodge any accumulated dust. (See the “TOP COVER REMOVAL” section for instructions on accessing the interior.) No other cleaning is recommended.

TRIGGER DAMAGE

The rear-panel TRIG input, used in the external trigger mode, is protected by a diode clamping circuit. However, the protection circuit is not foolproof, and it is possible for a grossly excessive signal to damage the trigger circuitry on the main timing control board (the 4×10 inch board on the right side of the instrument).

The IC that is most likely to fail under these conditions is installed in a socket. It is a standard TTL IC in a 16-pin plastic DIP package, model 74F151 or equivalent.

If you suspect that this IC has been damaged, turn off the power and replace this IC. It may be replaced by a 74F151, 74LS151, 74ALS151, or 74HCT151.

PROGRAMMING YOUR PULSE GENERATOR

KEY PROGRAMMING COMMANDS

The “Programming Manual for -B Instruments” describes in detail how to connect the pulse generator to your computer, and the programming commands themselves. A large number of commands are available; however, normally you will only need a few of these. Here is a basic sample sequence of commands that might be sent to the instrument after power-up:

```
*rst                (resets the instrument)
trigger:source internal (selects internal triggering)
frequency 10 Hz      (sets the frequency to 10 Hz)
pulse:delay 1 us     (sets the delay to 100 ns)
volt1 +1.5 kV        (sets the HV PULSE amplitude to +1.5 kV)
volt2 5.0            (sets VCC2 to +5.0V)
output on            (turns on the output)
```

The output will turn off automatically 90 seconds later, if no further commands are sent before then.

For triggering a single event, this sequence would be more appropriate:

```
*rst                (resets the instrument)
trigger:source hold (turns off all triggering)
volt1 -1.5 kV       (sets the HV PULSE amplitude to -1.5 kV)
volt2 5.0           (sets VCC2 to +5.0V)
output on           (turns on the output)
trigger:source immediate (generates a single non-repetitive trigger event)
trigger:source hold (turns off all triggering)
output off          (turns off the output)
```

To set the instrument to trigger from an external TTL signal applied to the rear-panel TRIG connector, use:

```
*rst                (resets the instrument)
trigger:source external (selects internal triggering)
pulse:delay 1 us     (sets the delay to 100 ns)
volt1 -1.5 kV        (sets the HV PULSE amplitude to -1.5 kV)
volt2 5.0           (sets VCC2 to +5.0V)
output on            (turns on the output)
```

These commands will satisfy 90% of your programming needs.

ALL PROGRAMMING COMMANDS

For more advanced programmers, a complete list of the available commands is given below. These commands are described in detail in the “Programming Manual for -B Instruments”. (Note: this manual also includes some commands that are not implemented in this instrument. They can be ignored.)

<u>Keyword</u>	<u>Parameter</u>	<u>Notes</u>
OUTPut:		
:STATe	<boolean value>	
:PROTection		
:TRIPped?		[query only]
[SOURce]:		
:FREQuency		
[:CW FIXed]	<numeric value>	
[SOURce]:		
:PULSe		
:PERiod	<numeric value>	
:HOLD	WIDTh DCYCLE	
:DELay	<numeric value>	
:GATE		
:TYPE	ASYNc SYNc	
:LEVel	HIGH LOW	
:VOLTage		
[:LEVel]		
[:IMMediate]		
[:AMPLitude]	<numeric value> EXTERNAL	
STATUS:		
:OPERation		
:[EVENT]?		[query only, always returns "0"]
:CONDition?		[query only, always returns "0"]
:ENABle	<numeric value>	[implemented but not useful]
:QUEStionable		
:[EVENT]?		[query only, always returns "0"]
:CONDition?		[query only, always returns "0"]
:ENABle	<numeric value>	[implemented but not useful]
SYSTEM:		
:COMMunicate		
:GPIB		
:ADDRes	<numeric value>	
:SERial		
:CONTRol		
:RTS	ON IBFull RFR	
:[RECeive]		
:BAUD	1200 2400 4800 9600 19200 38400 57600 115200	
:ERRor		
:[NEXT]?		[query only]
:COUNT?		[query only]
:VERSion?		[query only]
TRIGger:		
:SOURce	INTERNAL EXTERNAL MANUAL HOLD IMMEDIATE	
*CLS		[no query form]
*ESE	<numeric value>	
*ESR?		[query only]
*IDN?		[query only]

*OPC		
*SAV	0 1 2 3	[no query form]
*RCL	0 1 2 3	[no query form]
*RST		[no query form]
*SRE	<numeric value>	
*STB?		[query only]
*TST?		[query only]
*WAI		[no query form]

WIRING DIAGRAMS

WIRING OF AC POWER

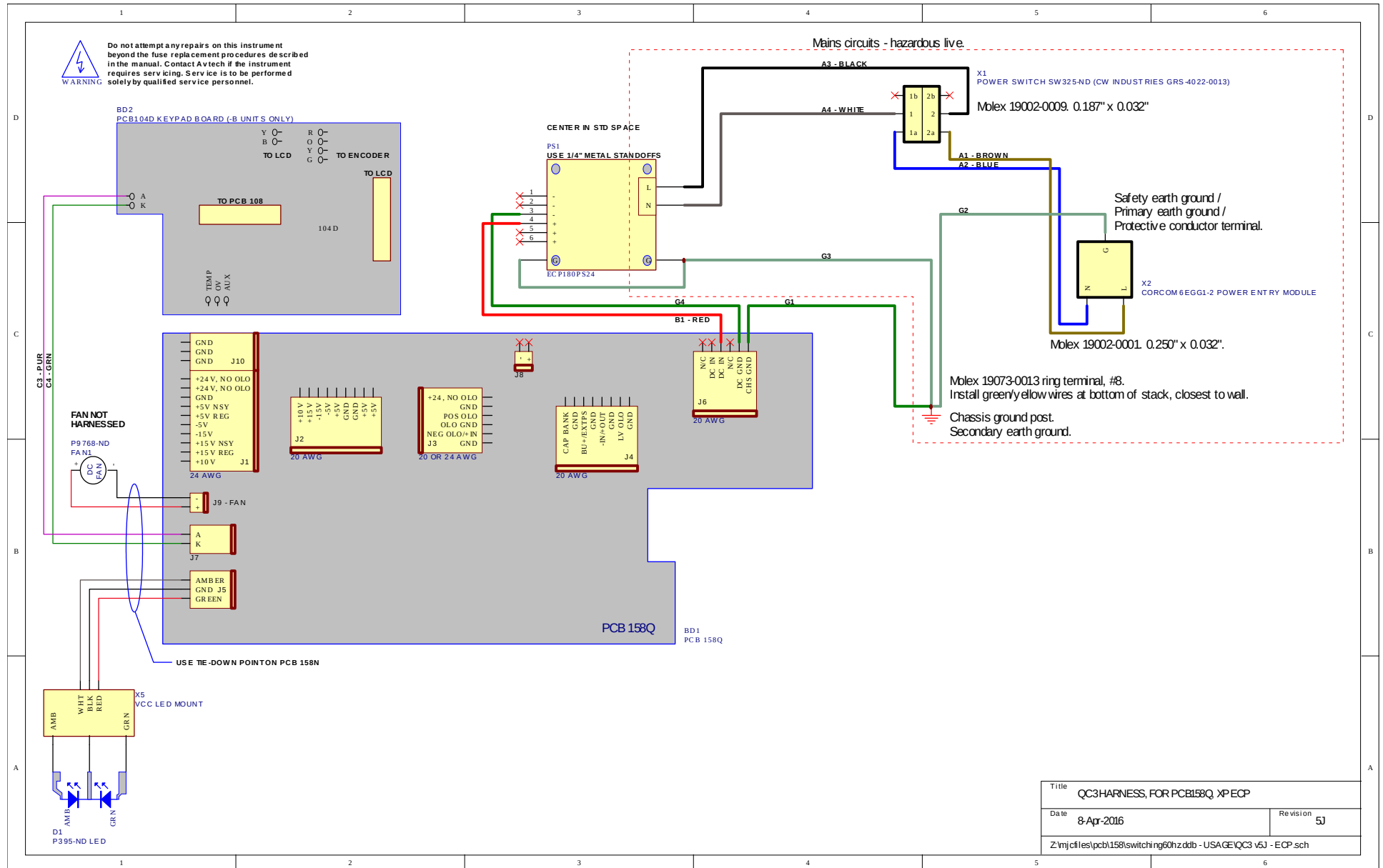

Title		QC3 HARNESS, FOR PCB158Q, XP/ECP	
Date	8-Apr-2016	Revision	5J
Z:\njcf\es\pcb158\switching60hzddb - USA GE\QC3 v5J - ECP.sch			

WIRING OF +54VDC POWER RAIL

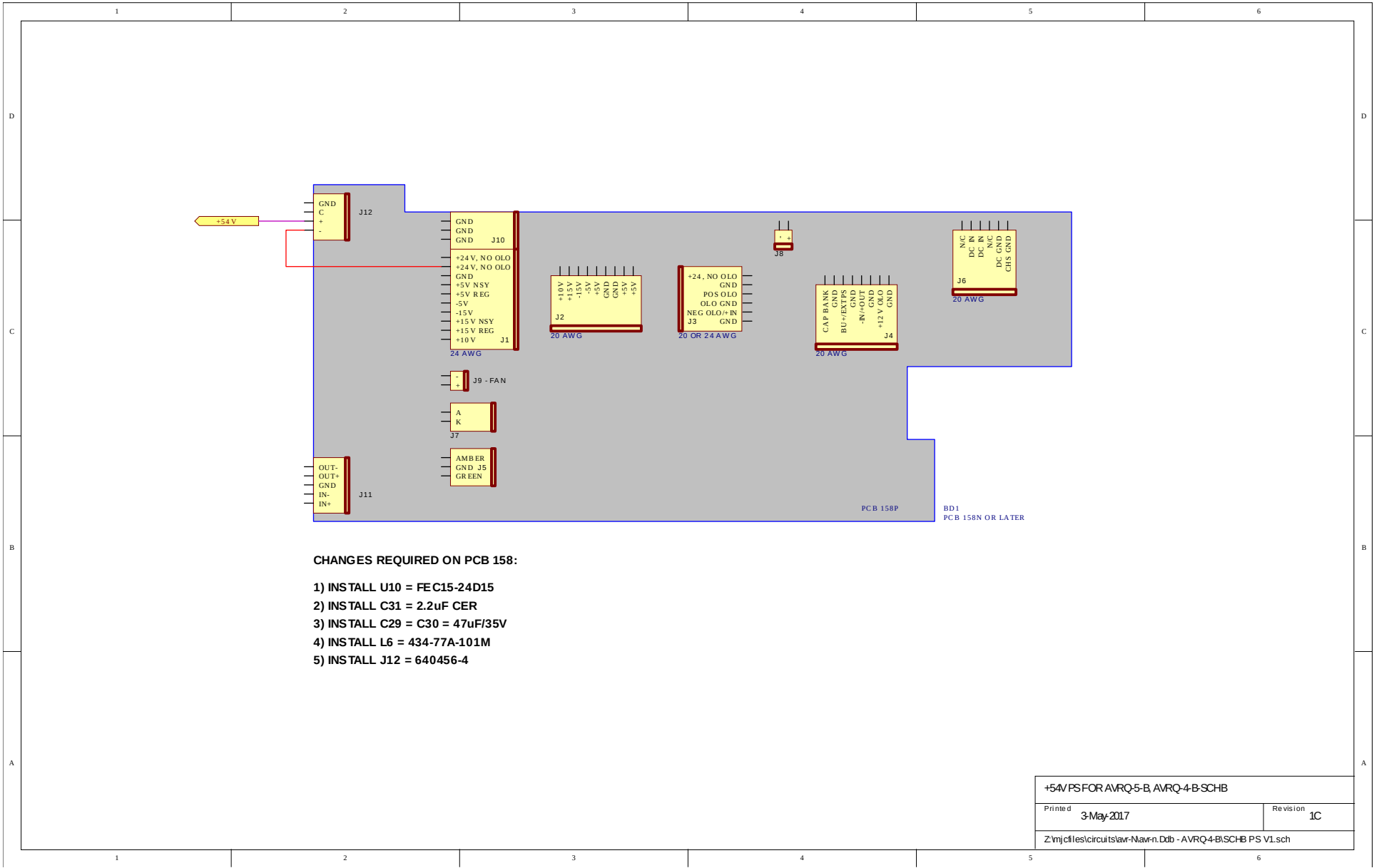

CHANGES REQUIRED ON PCB 158:

- 1) INSTALL U10 = FEC15-24D15
- 2) INSTALL C31 = 2.2uF CER
- 3) INSTALL C29 = C30 = 47uF/35V
- 4) INSTALL L6 = 434-77A-101M
- 5) INSTALL J12 = 640456-4

+54V PS FOR AVRQ-5-B, AVRQ-4-B-SCHB	
Printed 3-May-2017	Revision 1C
Z:\mjcf\es\circuits\avr-Nav-n.Ddb - AVRQ-4-B-SCHB PS V1.Sch	

PCB 158Q - LOW VOLTAGE POWER SUPPLY, 1/3

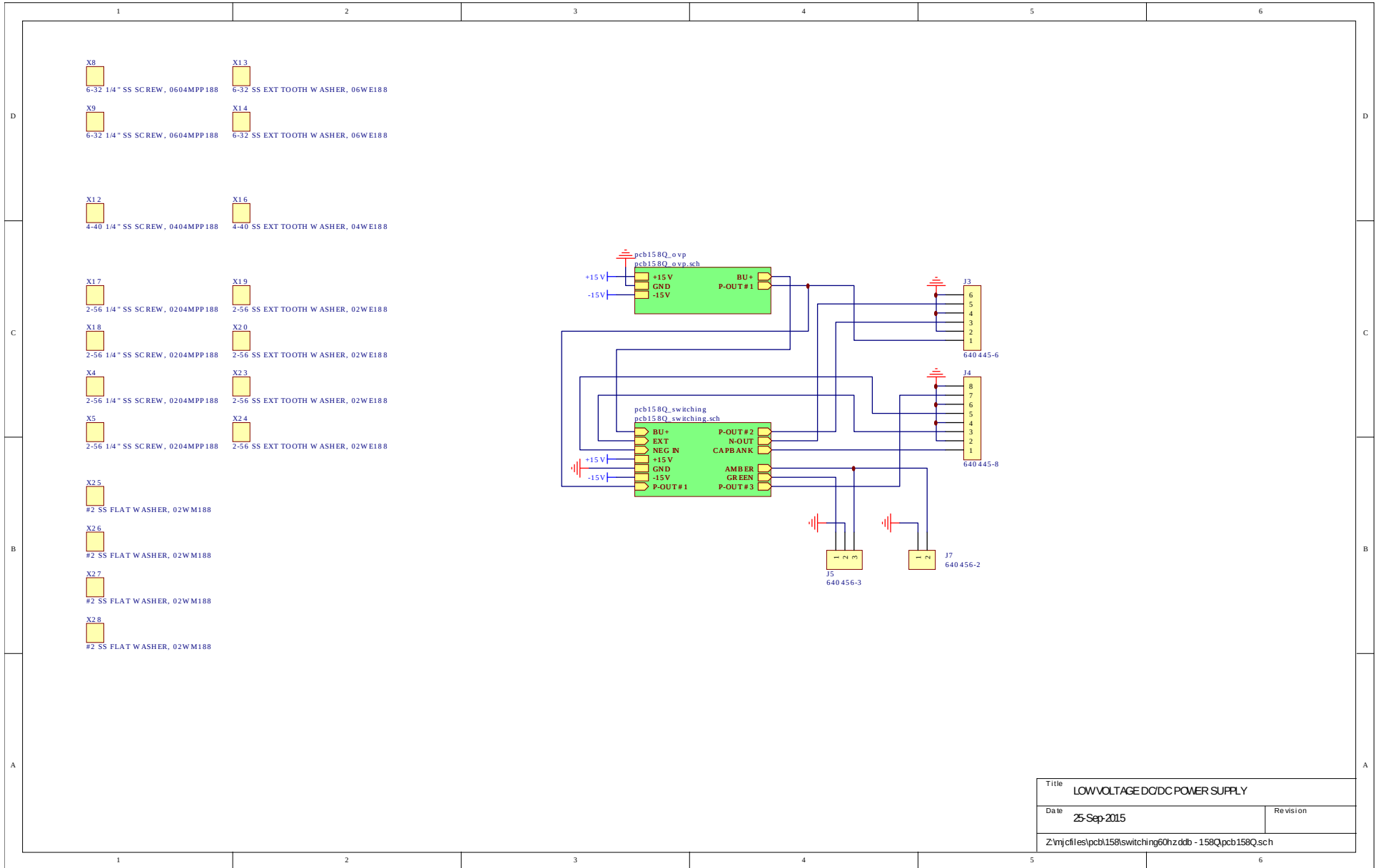

Title		LOW VOLTAGE DC/DC POWER SUPPLY
Date	25-Sep-2015	Revision
Z:\njcf\es\pcb158\switching60hzddb - 158Q.pcb158Q.sch		

PCB 158Q - LOW VOLTAGE POWER SUPPLY, 2/3

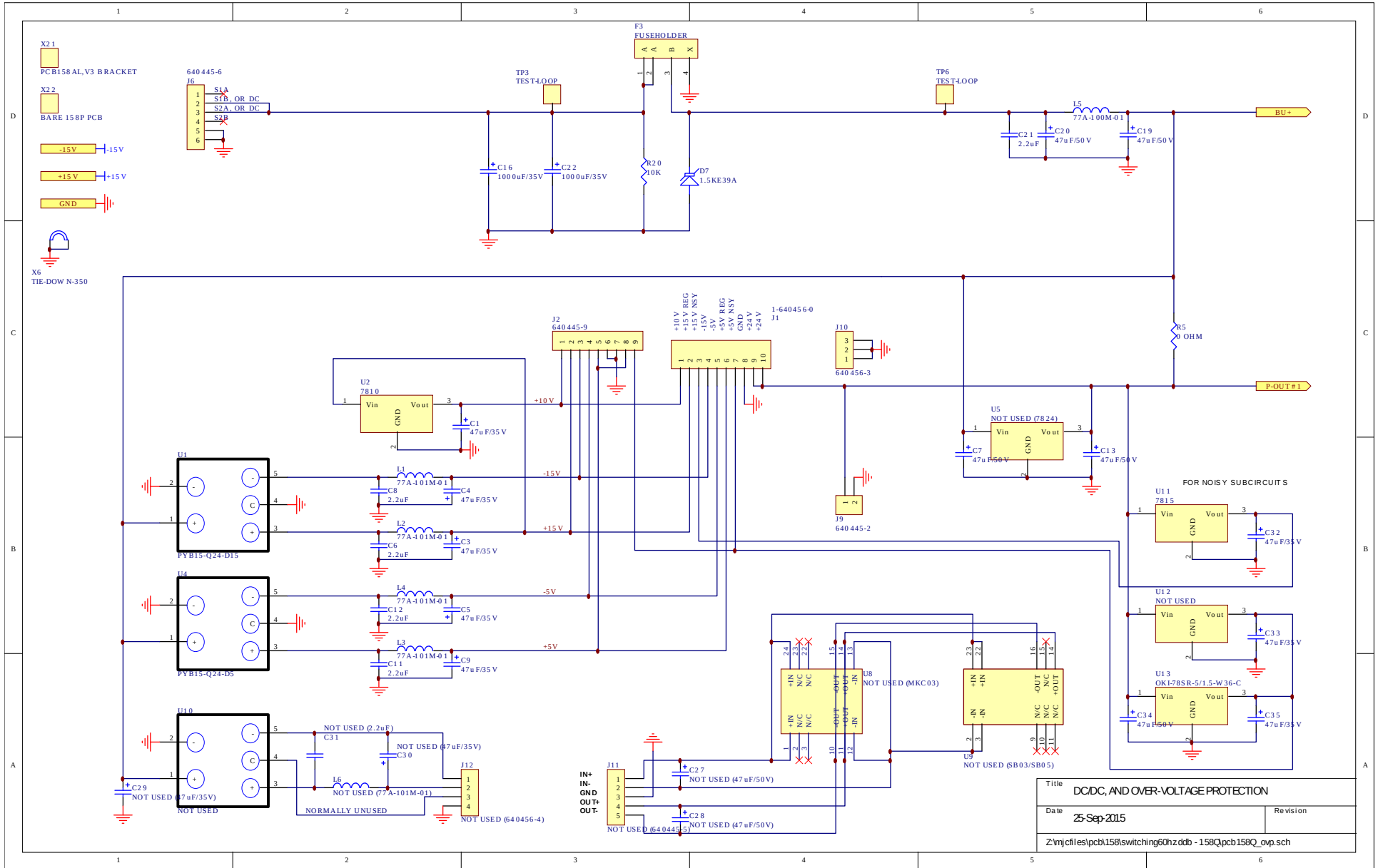

PCB 104F - KEYPAD / DISPLAY BOARD, 1/3

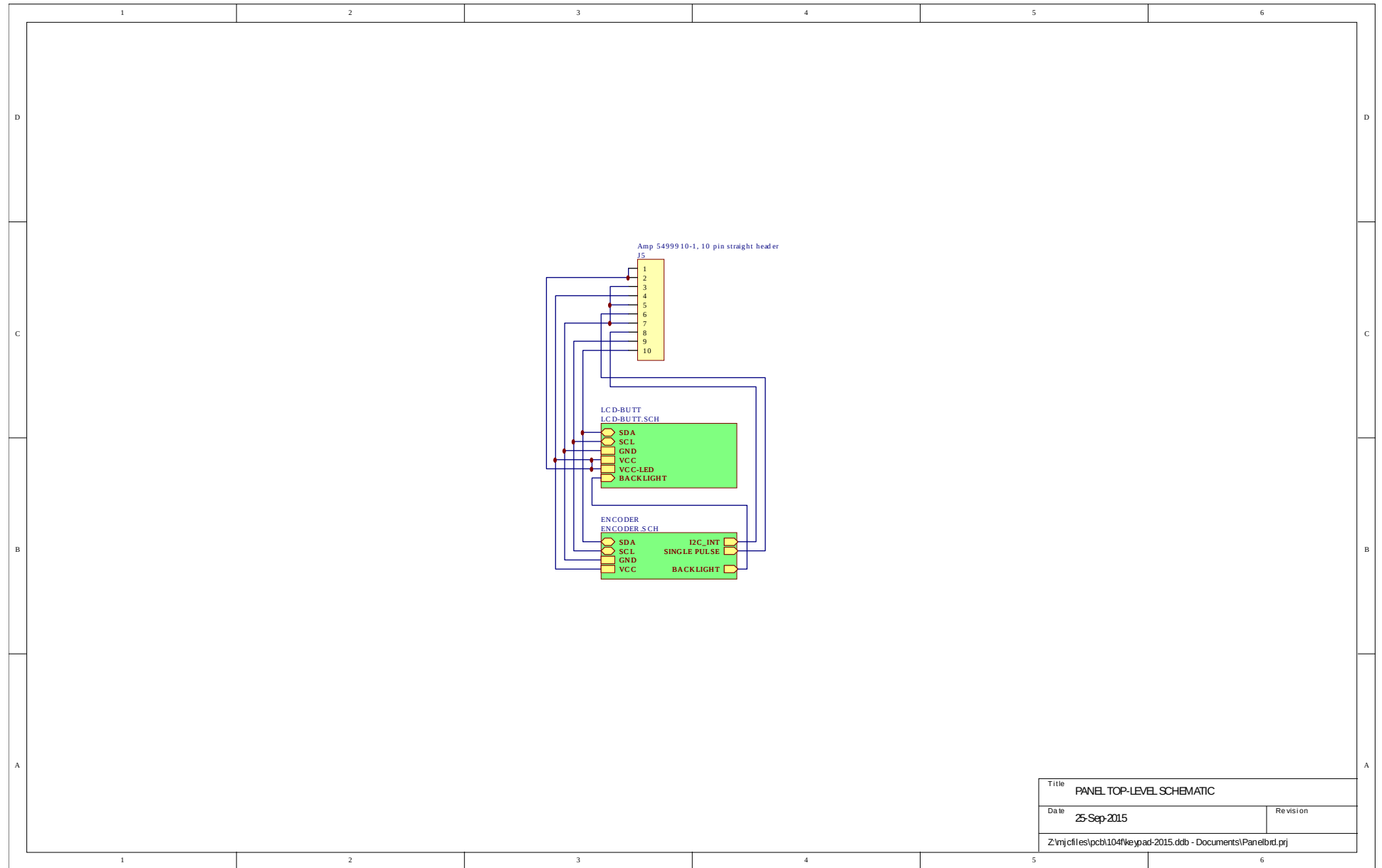

Title		PANEL TOP-LEVEL SCHEMATIC	
Date	25-Sep-2015	Revision	
Z:\njcf\es\pcb\104f\keypad-2015.ddb - Documents\Panelrd.prj			

PCB 104F - KEYPAD / DISPLAY BOARD, 2/3

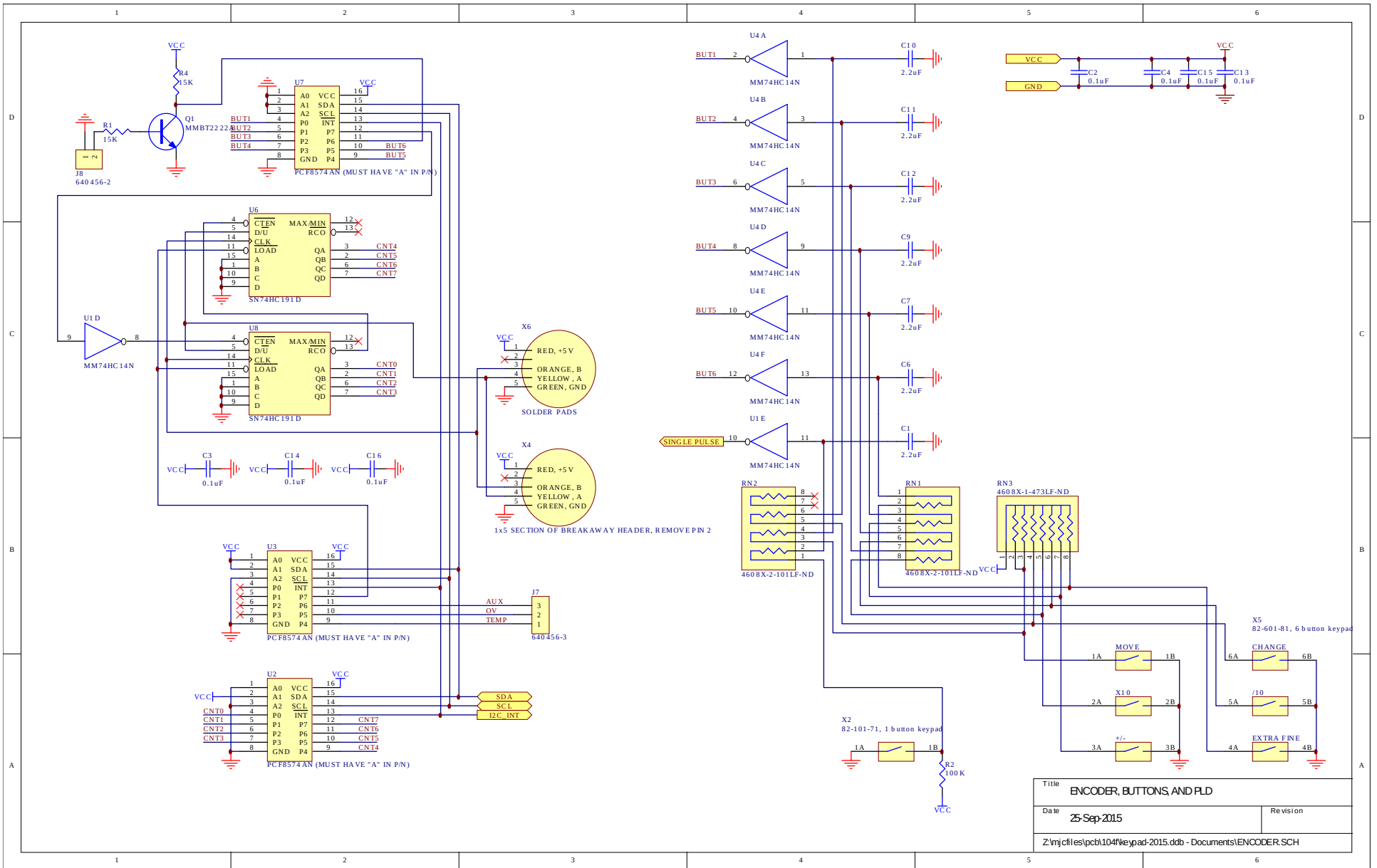

PCB 104F - KEYPAD / DISPLAY BOARD, 3/3

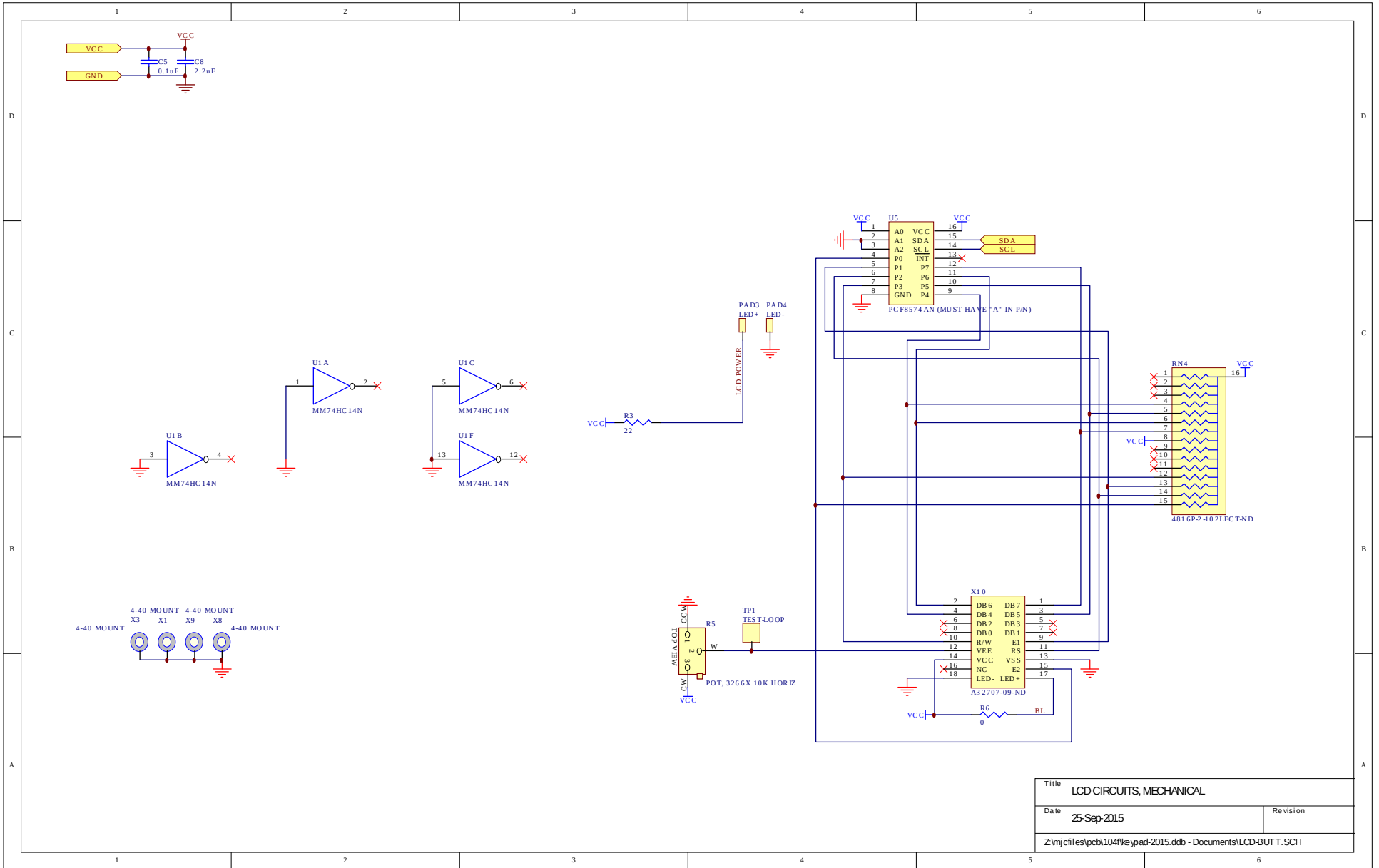

Title		LCD CIRCUITS, MECHANICAL
Date	25-Sep-2015	Revision
Z:\njcf\es\pcb\104f\keypad-2015.ddb - Documents\LCD-BUT.T.SCH		

DUT WIRING, ON MAIN PCB

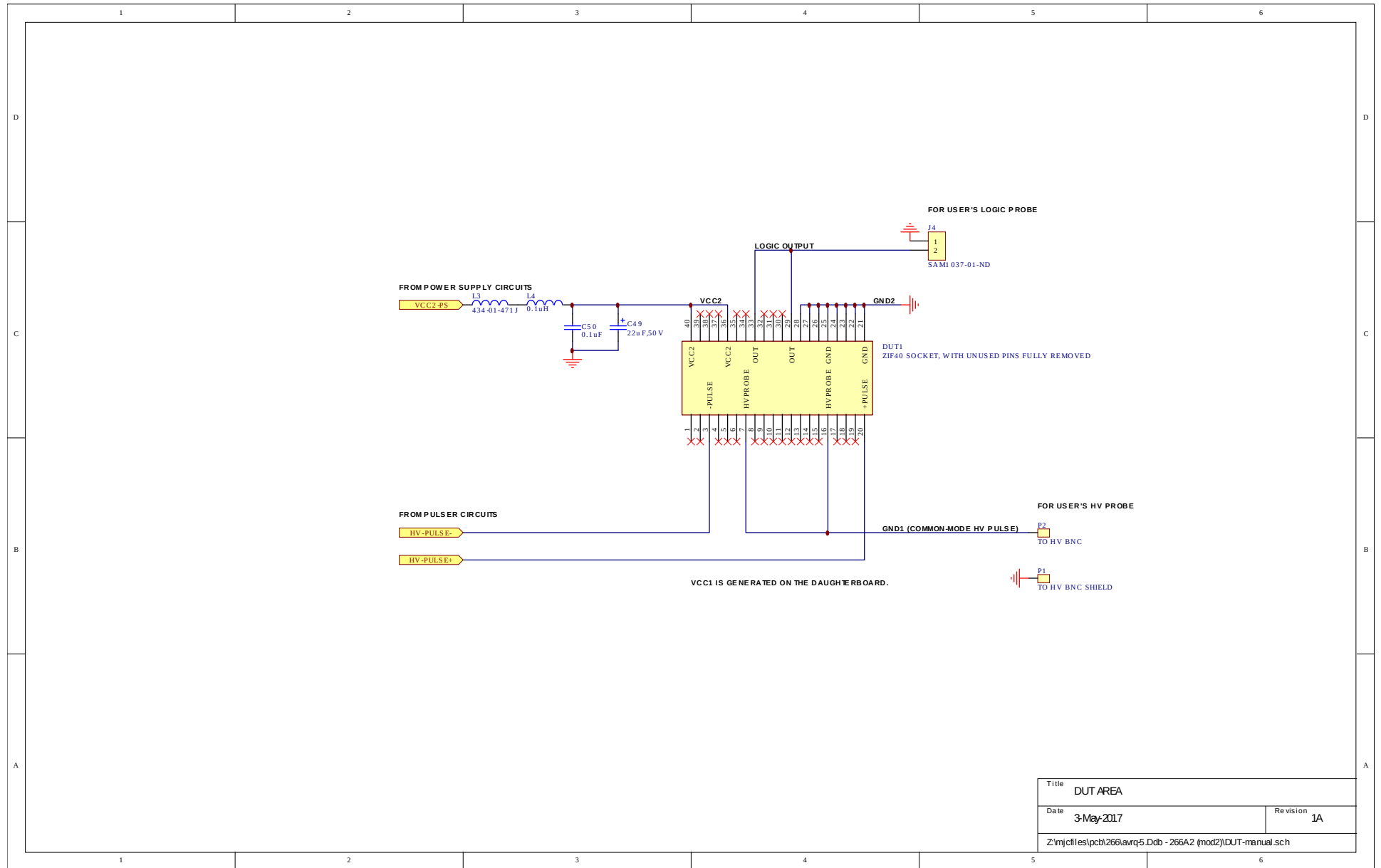

Title		DUT AREA
Date	3-May-2017	Revision 1A
Z:\njcfl\es\pcb\266\avrq5.Ddb - 266A2 (mod2)\DUT-manual.sch		

DUT WIRING, ON STANDARD DAUGHTERBOARD (PCB 267C)

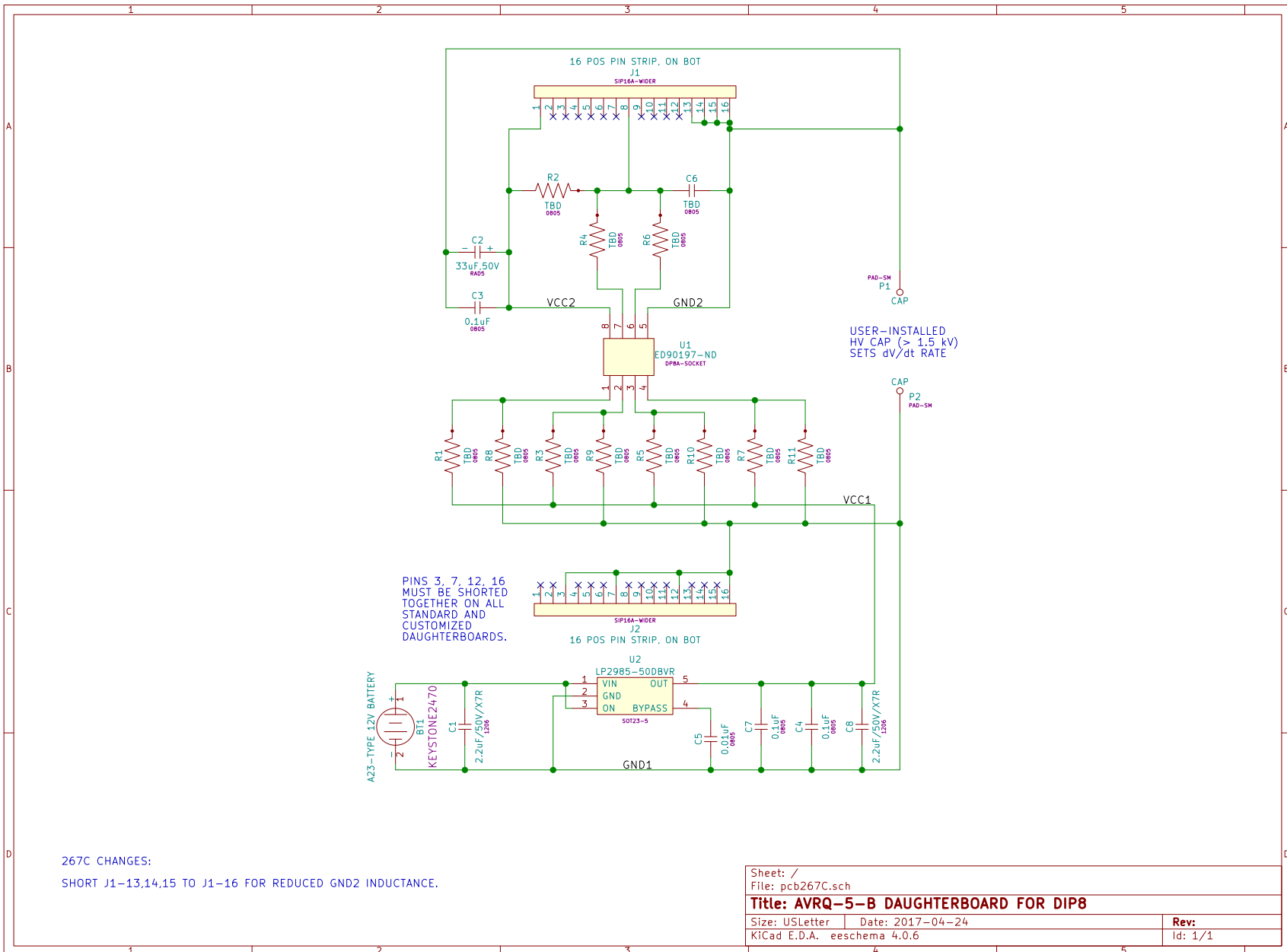

Sheet: /		File: pcb267C.sch	
Title: AVRQ-5-B DAUGHTERBOARD FOR DIP8			
Size: USLetter	Date: 2017-04-24	Rev:	
KiCad E.D.A.	eeschema 4.0.6	Id: 1/1	

DUT WIRING, ON CUSTOMIZED TLP2366 DAUGHTERBOARD (PCB 298B)

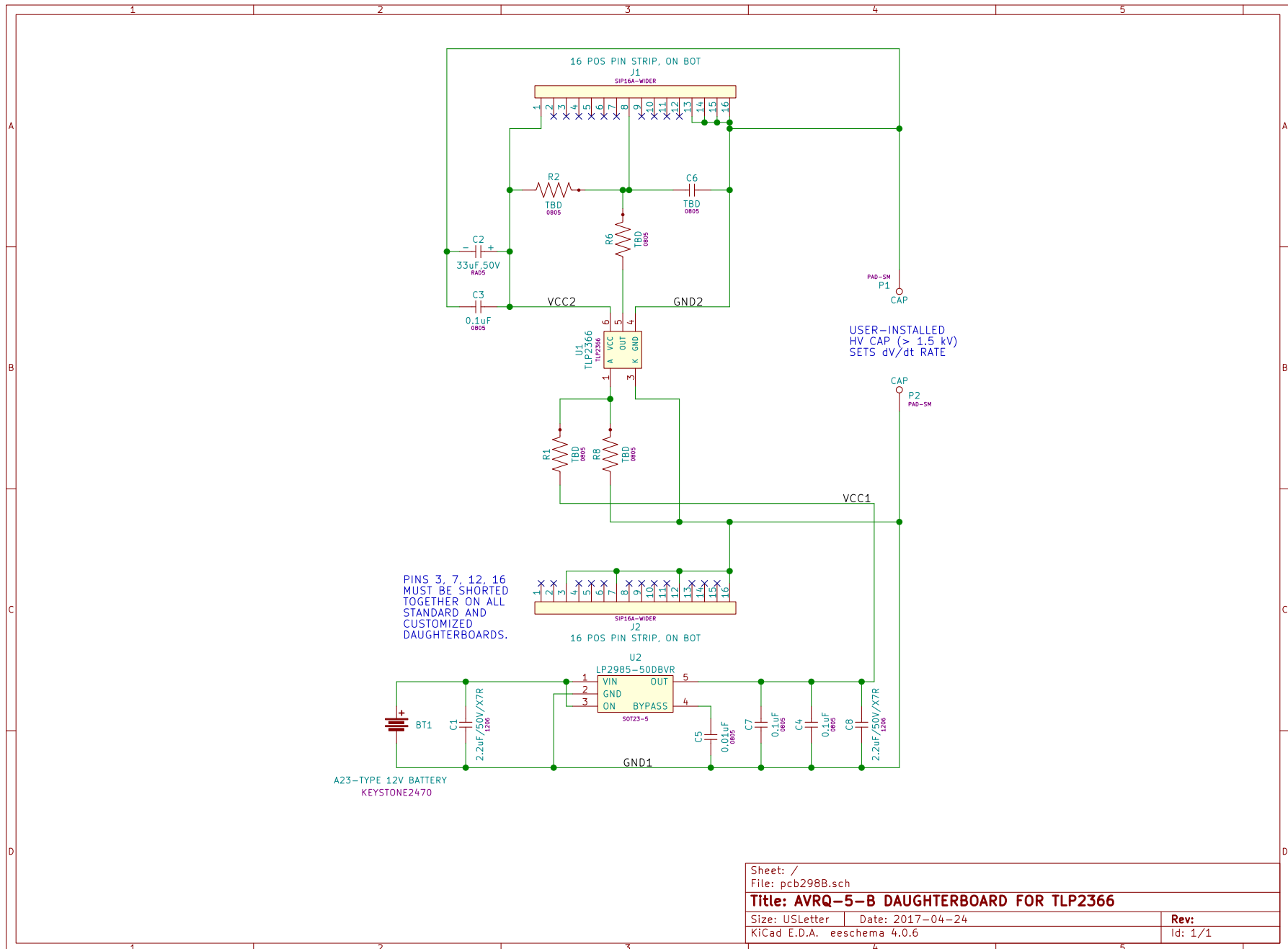

Sheet: /		
File: pcb298B.sch		
Title: AVRQ-5-B DAUGHTERBOARD FOR TLP2366		
Size: USLetter	Date: 2017-04-24	Rev:
KiCad E.D.A. eeschema 4.0.6		Id: 1/1

DUT WIRING, ON CUSTOMIZED ADUM241E0BRWZ DAUGHTERBOARD (PCB 299B)

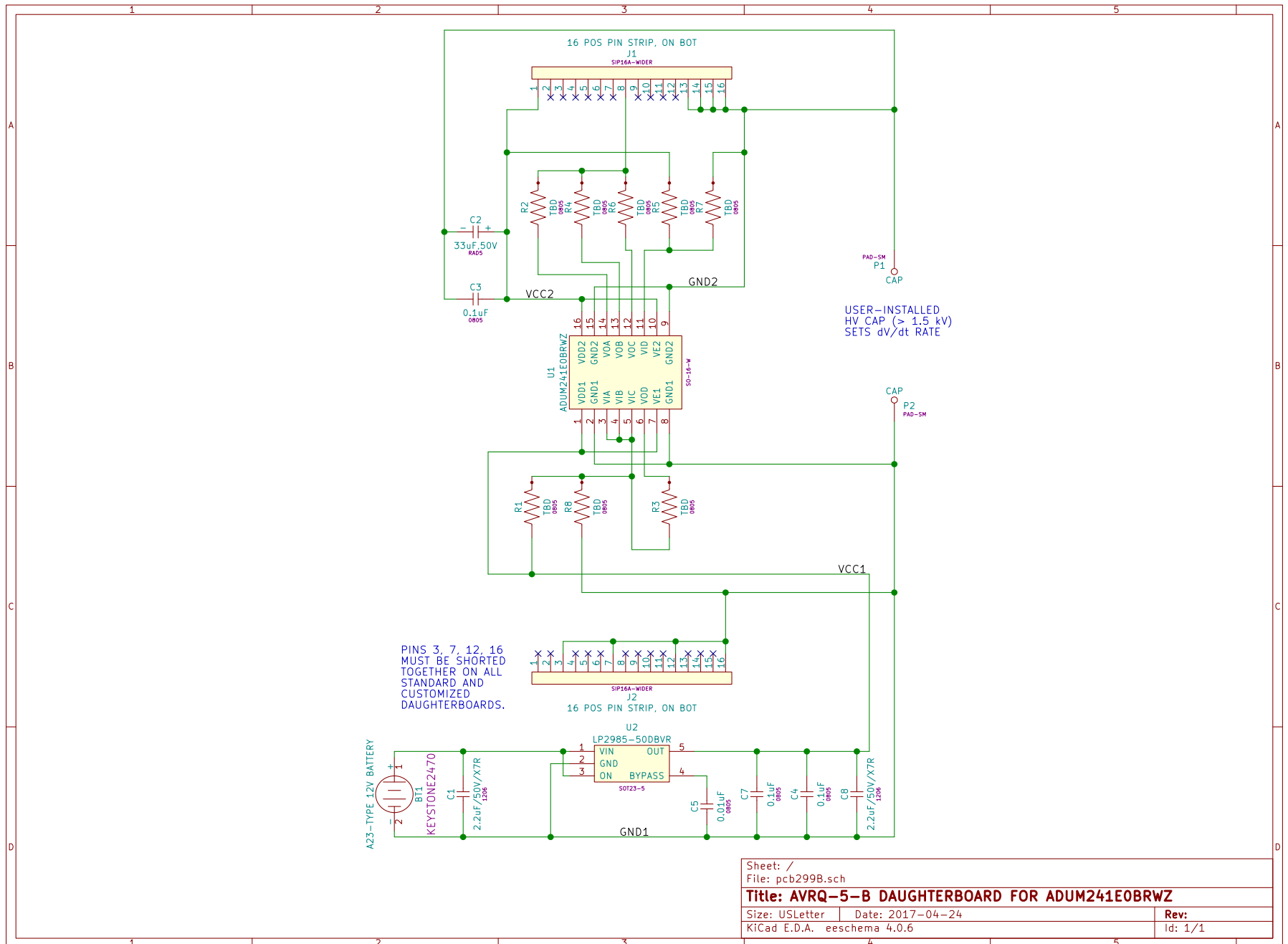

MAIN WIRING

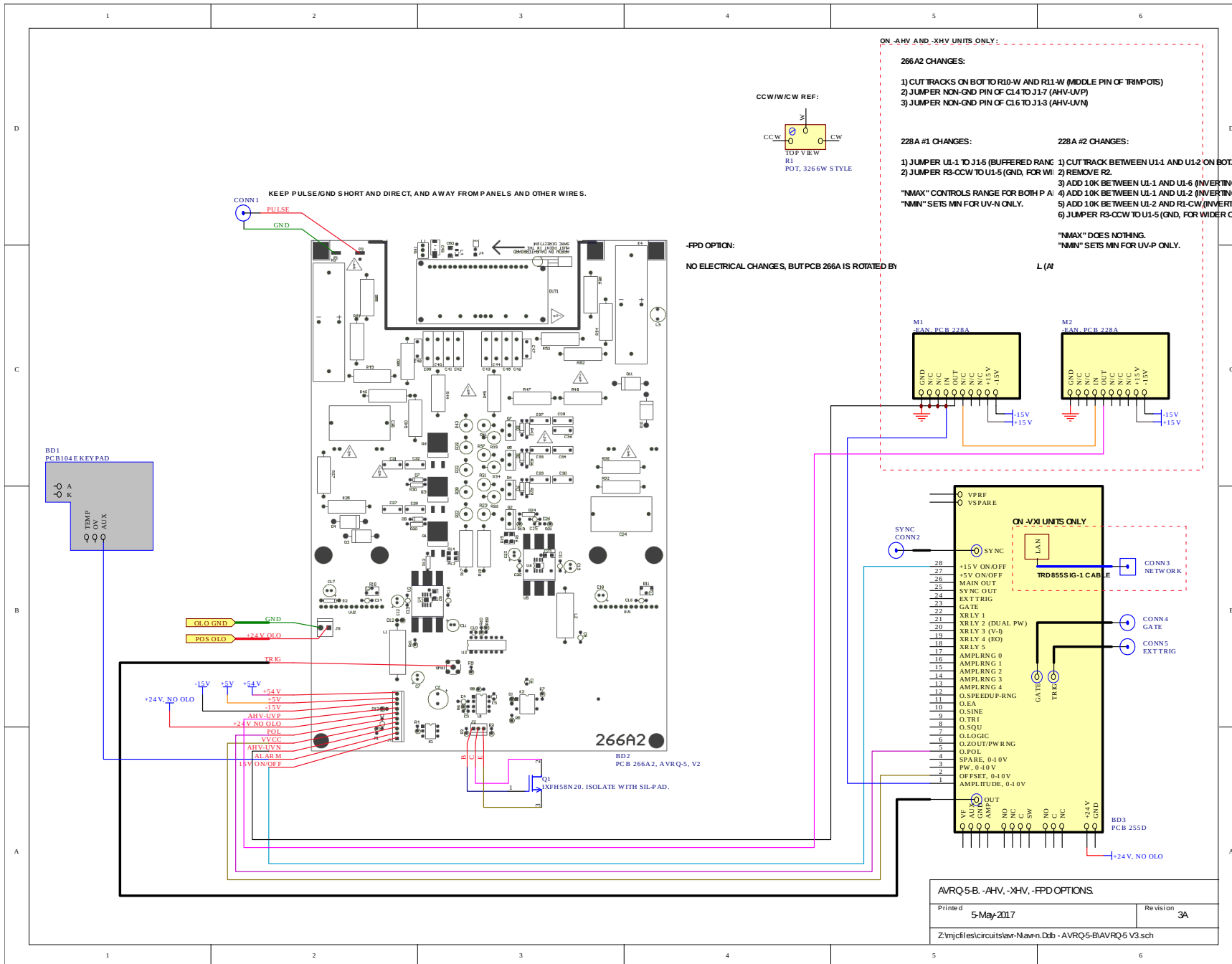

PERFORMANCE CHECK SHEET