



AVTECH ELECTROSYSTEMS LTD.

NANOSECOND WAVEFORM ELECTRONICS
SINCE 1975

P.O. BOX 265
OGDENSBURG, NY
U.S.A. 13669-0265

TEL: 888-670-8729 (USA & Canada) or +1-613-686-6675 (Intl)
FAX: 800-561-1970 (USA & Canada) or +1-613-686-6679 (Intl)

info@avtechpulse.com - <http://www.avtechpulse.com/>

BOX 5120, LCD MERIVALE
OTTAWA, ONTARIO
CANADA K2C 3H5

INSTRUCTIONS

MODEL AVRQ-4-B

± 1 kV and ± 1.5 kV AMPLITUDE,

25 ns to 250 ns ADJUSTABLE RISE TIME,

PULSE GENERATORS FOR

COMMON MODE TRANSIENT IMMUNITY (CMTI) TESTS

SERIAL NUMBER: _____

WARRANTY

Avtech Electrosystems Ltd. warrants products of its manufacture to be free from defects in material and workmanship under conditions of normal use. If, within one year after delivery to the original owner, and after prepaid return by the original owner, this Avtech product is found to be defective, Avtech shall at its option repair or replace said defective item. This warranty does not apply to units which have been disassembled, modified or subjected to conditions exceeding the applicable specifications or ratings. This warranty is the extent of the obligation assumed by Avtech with respect to this product and no other warranty or guarantee is either expressed or implied.

TECHNICAL SUPPORT

Phone: 888-670-8729 (USA & Canada) or +1-613-686-6675 (International)

Fax: 800-561-1970 (USA & Canada) or +1-613-686-6679 (International)

E-mail: info@avtechpulse.com

World Wide Web: <http://www.avtechpulse.com>

TABLE OF CONTENTS

WARRANTY.....	2
TECHNICAL SUPPORT.....	2
TABLE OF CONTENTS.....	3
INTRODUCTION.....	6
HIGH-VOLTAGE PRECAUTIONS.....	8
SPECIFICATIONS.....	9
REGULATORY NOTES.....	10
FCC PART 18.....	10
EC DECLARATION OF CONFORMITY.....	10
DIRECTIVE 2011/65/EU (RoHS).....	11
DIRECTIVE 2002/96/EC (WEEE).....	11
FIRMWARE LICENSING.....	12
INSTALLATION.....	13
VISUAL CHECK.....	13
POWER RATINGS.....	13
CONNECTION TO THE POWER SUPPLY.....	13
PROTECTION FROM ELECTRIC SHOCK.....	14
ENVIRONMENTAL CONDITIONS.....	15
FUSES.....	16
AC FUSE REPLACEMENT.....	16
DC FUSE REPLACEMENT.....	17
FUSE RATINGS.....	17
FRONT PANEL CONTROLS.....	18
REAR PANEL CONTROLS.....	20
GENERAL INFORMATION.....	23
BASIC PULSE CONTROL.....	23
TRIGGER MODES.....	24
GATING MODES.....	25
DUT INSTALLATION.....	26
PIN SOCKET PINOUT.....	26
SAMPLE DAUGHTERBOARD WIRING.....	27
SAMPLE DAUGHTERBOARD – PIN 7 ISSUES.....	28
SAMPLE DAUGHTERBOARD – SOCKETING ISSUES.....	28

SAMPLE DAUGHTERBOARD – DRIVER FILTERING ISSUES.....	28
SAMPLE DAUGHTERBOARD – LOADING ISSUES.....	29
SAMPLE DAUGHTERBOARD – PIN STRIPS.....	29
SO-8 DAUGHTERBOARDS.....	29
OTHER DAUGHTERBOARDS.....	29
DIFFERENTIAL PROBING.....	30
SAMPLE DAUGHTERBOARD CONFIGURATIONS.....	30
INSTALLING THE DAUGHTERBOARDS.....	31
UNPOPULATED DAUGHTERBOARDS.....	31
<i>BASIC TEST ARRANGEMENT.....</i>	32
<i>TYPICAL WAVEFORMS.....</i>	34
BASIC THEORY.....	34
TYPICAL RESULTS, “A” DAUGHTERBOARD.....	35
TRW 6N137, “A” DAUGHTERBOARD.....	35
HP HCPL-2601, “A” DAUGHTERBOARD.....	36
QTC HCPL-2601, “A” DAUGHTERBOARD.....	36
SAMPLE 5, “A” DAUGHTERBOARD.....	37
TYPICAL RESULTS, “D” DAUGHTERBOARD.....	37
HP HCPL-2601, “D” DAUGHTERBOARD.....	37
QTC HCPL-2601, “D” DAUGHTERBOARD.....	38
SAMPLE 1, “D” DAUGHTERBOARD.....	39
SAMPLE 1, “D7” DAUGHTERBOARD.....	39
<i>VERIFICATION AND TROUBLESHOOTING.....</i>	40
<i>SAFETY CONCERNS.....</i>	42
TURN OUTPUT OFF BEFORE ACCESSING DUT.....	42
AUTOMATIC TIMEOUT.....	42
OVERLOAD INDICATOR.....	42
<i>OPERATIONAL CHECK.....</i>	43
<i>PROTECTING YOUR INSTRUMENT.....</i>	46
USE HIGH-VOLTAGE CABLES, CONNECTORS, AND PROBES.....	46
SHORT-CIRCUIT PROTECTION.....	46
<i>MECHANICAL INFORMATION.....</i>	47
TOP COVER REMOVAL.....	47
RACK MOUNTING.....	47
<i>MAINTENANCE.....</i>	48

REGULAR MAINTENANCE.....	48
CLEANING.....	48
TRIGGER DAMAGE.....	48
PROGRAMMING YOUR PULSE GENERATOR.....	49
KEY PROGRAMMING COMMANDS.....	49
ALL PROGRAMMING COMMANDS.....	51
WIRING DIAGRAMS.....	53
WIRING OF AC POWER.....	53
WIRING OF DC POWER FOR -SCHB OPTION.....	54
PCB 158R3 - LOW VOLTAGE POWER SUPPLY.....	55
PCB 104F - KEYPAD / DISPLAY BOARD, 1/3.....	56
PCB 104F - KEYPAD / DISPLAY BOARD, 2/3.....	57
PCB 104F - KEYPAD / DISPLAY BOARD, 3/3.....	58
FLOATING +5V AND DUT WIRING, ON MAIN PCB.....	59
DUT WIRING, ON STANDARD DAUGHTERBOARD (PCB 213B, 213B7).....	60
DUT WIRING, ON SO-8 DAUGHTERBOARD (PCB 263A).....	61
MAIN WIRING.....	62
PERFORMANCE CHECK SHEET.....	63

Manual Reference: /files/server1/officefiles/instructword/avrq/obs/AVRQ-4-B,edition11.odt.

Last modified February 29, 2024.

Copyright © 2024 Avtech Electrosystems Ltd, All Rights Reserved.

INTRODUCTION

The AVRQ-4-B is designed to test the common mode transient immunity (CMTI) of opto-couplers.

The AVRQ-4-B offers four pulse amplitudes (-1.5kV, -1kV, +1kV and +1.5 kV), with the transition time (10%-90%) of the leading edge variable from less than 25 ns to more than 250 ns. The high-voltage pulse is applied between the floating ground on the input side (GND1) and the chassis-ground on the output side (GND2). A user-supplied 9V battery is installed to provide a floating regulated +5V power source (VCC1), which may be used to power a voltage-drive device directly, or it may be connected through a series resistance to drive current-biased devices. A chassis-ground-referenced power supply (VCC2) is provided on the output side, and is adjustable from +3V to +8V (or up to +43V, with the -SCHB option).

The AVRQ-4-B provides the high-voltage pulse, and the two stable bias voltages (VCC1 and VCC2). The user is responsible for configuring the daughterboards to implement the correct biasing, filtering, loading, socketing, and glitch measurement.

The AVRQ-4-B provides a pattern of pin sockets into which a daughterboard may be plugged. Several sample daughterboards are included with each AVRQ-4-B, to accommodate common test configurations for common 8-pin DIP voltage-drive and current-drive optocouplers. The logic inputs on voltage-drive opto-couplers are jumpered to VCC1 or GND1, as appropriate. For current-drive optocouplers, the LED anode is connected to GND1 directly or to VCC1 through a series resistor. The output side of the daughterboard includes provision for installing a pull-up resistor to VCC2, if required, as well as an optional capacitance to GND2. To perform tests with different logic-level inputs or values of pull-up resistance, different daughterboards must be plugged in. Jumpers are provided to configure the daughterboards for single or dual-channel pinouts.

The rise time (measured 10%-90%) of the high-voltage pulse may be varied over the range of < 25 ns to > 250 ns. This is the "TR" setting shown on the front panel. It may be set from the front-panel, or by using a command of the form "pulse:transition 50 ns". The rise time control is NOT calibrated, since it is strongly influenced by device capacitance and other parasitic effects. Also, the 1 kV waveforms are essentially "clipped" versions of the 1.5 kV waveforms, so the actual rise times for 1 kV waveforms will be ~2/3 of the set value. The actual rise time must be measured by the user, and it may differ significantly from the set value.

The high-voltage pulse and the logic output of the DUT must be measured by the user, using suitable high-impedance oscilloscope probes. Coaxial cabling should not be used. Normally, the user will decrease the rise time of the high voltage pulse until logic-level "glitches" are observed on the logic output.

The AVRQ-4-B features front panel keyboard and adjust knob control of the output pulse parameters along with a four line by 40-character backlit LCD display of the rise

time, pulse width, pulse delay, and pulse repetition frequency. The instrument includes memory to store up to four complete instrument setups. The operator may use the front panel or the computer interface to store a complete “snapshot” of all key instrument settings, and recall this setup at a later time.

This instrument is intended for use in research, development, test and calibration laboratories by qualified personnel.

HIGH-VOLTAGE PRECAUTIONS

 **CAUTION:** This instrument provides output voltages as high as 1500 Volts under normal operating conditions, and generates up to 1600V internally, so extreme caution must be employed when using this instrument. The instrument should only be used by individuals who are thoroughly skilled in high voltage laboratory techniques. The following precautions should always be observed:

1. Keep exposed high-voltage wiring to an absolute minimum.
2. Wherever possible, use shielded connectors and cabling.
3. Connect and disconnect loads and cables only when the instrument is turned off.
4. Keep in mind that all cables, connectors, oscilloscope probes, and loads must have an appropriate voltage rating.

Do not attempt any repairs on the instrument, beyond the fuse replacement procedures described in this manual. Contact Avtech technical support (see page 2 for contact information) if the instrument requires servicing.

SPECIFICATIONS

Model:	AVRQ-4-B ¹
High-Voltage Pulse Amplitude: (HV pulse / GND1)	-1.5, -1, +1, or +1.5 kV,
Load resistance:	> 10 Megohms (this is not a 50 Ohm system.)
Load capacitance (C _{LOAD}):	~15 pF total, including DUT capacitance and probes.
Load connection style:	A pattern of pin sockets into which a daughterboard may be plugged is provided. Sample daughterboards with 8-pin DIP sockets are included. The user may also use their own custom-made daughterboards.
Leading edge rise time ² (10% - 90%):	< 25 ns to > 250 ns, adjustable using front-panel settings or computer command.
Leading edge shape:	Approximately linear. See the typical waveform photos on the preceding and following pages.
Trailing edge fall time ³ (90% - 10%):	At least ten times greater than the leading edge rise time. Not adjustable.
Trailing edge shape:	Exponential decay, approximately.
Pulse width (measured between the start of the leading edge and the start of the falling edge):	1 - 20 μ s, adjustable.
PRF:	10 Hz maximum
VCC1 power supply (input side, floating, referenced to HV pulse / GND1):	+5V, fixed ⁶ . Generated by the mainframe and provided to the daughterboard socket. (The user may install a low-dropout voltage regulator on the daughterboard if a lower voltage is required.)
VCC2 power supply (output side, referenced to GND2 chassis ground):	Std: +3 to +8V, adjustable Optional ⁷ : +3 to +43V, adj.
Logic output pull-up resistance:	User-installed, on daughterboard as appropriate
Output connector, HV PULSE:	BNC female, suitable for use with the Tektronix P5100 high-voltage probe and 013-0291-00 probe-tip-to-BNC adapter
Output connector, logic output:	A two-pin header suitable for use with the Tektronix P6246 differential probe ⁸ . Other probes may be used by installing a matching two-pin socket as an extender.
Output enable timer:	The output will only remain active for 90 seconds after the last output parameter update. After that time, the output will be disabled. The output must be re-enabled from the front panel or by computer command for the next test sequence.
Propagation delay:	\leq 200 ns (Ext trig in to start of output pulse)
Jitter (Ext trig in to pulse out):	\pm 200 ps \pm 0.03% of sync delay
Trigger modes:	Internal trigger, external trigger (TTL level pulse, > 10 ns, 1 k Ω input impedance), front-panel "Single Pulse" pushbutton, or single pulse trigger via computer command.
Variable delay:	Sync to Out: 0 to 1.0 seconds, for all trigger modes (including external trigger).
Sync output:	+3 Volts, 100 ns, will drive 50 Ohm loads
Gate input:	Synchronous, active high or low, switchable. Suppresses triggering when active.
Other connectors:	Trig, Sync, Gate: BNC
GPIO and RS-232 control:	Yes. (Visit http://www.avtechpulse.com/labview for LabView drivers.)
Ethernet port, for remote control using VXI-11.3, ssh, telnet, & web:	Optional ⁴ . Recommended as a modern alternative to GPIO / RS-232. See http://www.avtechpulse.com/options/vxi for details.
Settings accuracy:	Not calibrated. Verify the output parameters with a calibrated oscilloscope.
Power requirements:	100 - 240 Volts, 50 - 60 Hz
Dimensions: (H x W x D)	145 x 430 x 475 mm (5.7" x 17" x 18.8")
Chassis material:	cast aluminum frame and handles, blue vinyl on aluminum cover plates
Temperature range:	+5°C to +40°C

- 1) -B suffix indicates IEEE-488.2 GPIO and RS-232 control of amplitude, pulse width, PRF and delay (See <http://www.avtechpulse.com/gpio/>).
- 2) The rise time is affected by the load capacitance. A high-voltage high-bandwidth oscilloscope probe such as the Tektronix P5100 should always be used to verify the actual output rise time, rather than relying on the programmed value.
- 3) Refers to the trailing edge, which swings from -1000V or -2000V to 0V
- 4) Add the suffix -VXI to the model number to specify the Ethernet port.
- 5) Note that coaxial cabling typically adds 30 pF/ft.
- 6) The user must install a standard 9V battery in the provided holder, in order to power the floating power supply. The battery is not included, due to shipping regulations.
- 7) To specify the extended VCC2 range, add the -SCHB option suffix to the model number.
- 8) A differential probe is suggested to reduce the possibility of interference from the high-voltage pulse. Note that the P6246 is only suitable for values of VCC2 up to +7V. A non-differential probe may be more suitable if VCC2 > 7V.

REGULATORY NOTES

FCC PART 18

This device complies with part 18 of the FCC rules for non-consumer industrial, scientific and medical (ISM) equipment.

This instrument is enclosed in a rugged metal chassis and uses a filtered power entry module (where applicable). The main output signal is provided on a shielded connector that is intended to be used with shielded coaxial cabling and a shielded load. Under these conditions, the interference potential of this instrument is low.

If interference is observed, check that appropriate well-shielded cabling is used on the output connectors. Contact Avtech (info@avtechpulse.com) for advice if you are unsure of the most appropriate cabling. Also, check that your load is adequately shielded. It may be necessary to enclose the load in a metal enclosure.

If any of the connectors on the instrument are unused, they should be covered with shielded metal "dust caps" to reduce the interference potential.

This instrument does not normally require regular maintenance to minimize interference potential. However, if loose hardware or connectors are noted, they should be tightened. Contact Avtech (info@avtechpulse.com) if you require assistance.

EC DECLARATION OF CONFORMITY



We Avtech Electrosystems Ltd.
 P.O. Box 5120, LCD Merivale
 Ottawa, Ontario
 Canada K2C 3H5

declare that this pulse generator meets the intent of Directive 2004/108/EG for Electromagnetic Compatibility. Compliance pertains to the following specifications as listed in the official Journal of the European Communities:

EN 50081-1 Emission

EN 50082-1 Immunity

and that this pulse generator meets the intent of the Low Voltage Directive 72/23/EEC as amended by 93/68/EEC. Compliance pertains to the following specifications as listed in the official Journal of the European Communities:

EN 61010-1:2001 Safety requirements for electrical equipment for measurement, control, and laboratory use

DIRECTIVE 2011/65/EU (RoHS)

We Avtech Electrosystems Ltd.
P.O. Box 5120, LCD Merivale
Ottawa, Ontario
Canada K2C 3H5

declare that, to the best of our knowledge, all electrical and electronic equipment (EEE) sold by the company are in compliance with Directive 2011/65/EU of the European Parliament and of the Council of 8 June 2011 on the restriction of the use of certain hazardous substances in electrical and electronic equipment (also known as “RoHS Recast”). In addition, this declaration of conformity is issued under the sole responsibility of Avtech Electrosystems Ltd. Specifically, products manufactured do not contain the substances listed in the table below in concentrations greater than the listed maximum value.

<i>Material/Substance</i>	<i>Threshold level</i>
Lead (Pb)	< 1000 ppm (0.1% by mass)
Mercury (Hg)	< 1000 ppm (0.1% by mass)
Hexavalent Chromium (Cr6+)	< 1000 ppm (0.1% by mass)
Polybrominated Biphenyls (PBB)	< 1000 ppm (0.1% by mass)
Polybrominated Diphenyl ethers (PBDE)	< 1000 ppm (0.1% by mass)
Cadmium (Cd)	< 100 ppm (0.01% by mass)

DIRECTIVE 2002/96/EC (WEEE)

European customers who have purchased this equipment directly from Avtech will have completed a “WEEE Responsibility Agreement” form, accepting responsibility for WEEE compliance (as mandated in Directive 2002/96/EC of the European Union and local laws) on behalf of the customer, as provided for under Article 9 of Directive 2002/96/EC.

Customers who have purchased Avtech equipment through local representatives should consult with the representative to determine who has responsibility for WEEE

compliance. Normally, such responsibilities will lie with the representative, unless other arrangements (under Article 9) have been made.

Requirements for WEEE compliance may include registration of products with local governments, reporting of recycling activities to local governments, and financing of recycling activities.

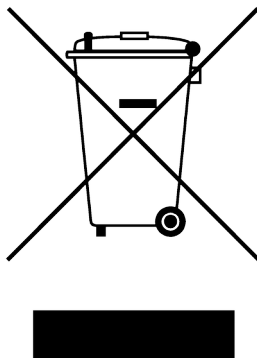

FIRMWARE LICENSING

Instruments with firmware versions 5.00 or higher use open-source software internally. Some of this software requires that the source code be made available to the user as a condition of its licensing. This source code is available upon request (contact info@avtechpulse.com).

Earlier firmware versions do not contain any open source software.

INSTALLATION

VISUAL CHECK

After unpacking the instrument, examine to ensure that it has not been damaged in shipment. Visually inspect all connectors, knobs, liquid crystal displays (LCDs), and the handles. Confirm that a power cord, a GPIB cable, and two instrumentation manuals (this manual and the “Programming Manual for -B Instruments”) are with the instrument. If the instrument has been damaged, file a claim immediately with the company that transported the instrument.

The following items should be with the instrument:

1. One rail of spare pin headers.
2. Six normal populated daughterboards (labeled “A” - “F”).
3. Six daughterboards with pin 7 drilled out (labeled “A7” - “F7”).
4. Six spare unpopulated daughterboards (PCB 213B).
5. Six spare unpopulated daughterboards with pin 7 drilled out (PCB 213B7).
6. Units with the -SO8 option will also have 32 spare SO-8 daughterboards (PCB 263A).

POWER RATINGS

This instrument is intended to operate from 100 - 240 V, 50 - 60 Hz.

The maximum power consumption is 57 Watts. Please see the “FUSES” section for information about the appropriate AC and DC fuses.

This instrument is an “Installation Category II” instrument, intended for operation from a normal single-phase supply.

CONNECTION TO THE POWER SUPPLY

An IEC-320 three-pronged recessed male socket is provided on the back panel for AC power connection to the instrument. One end of the detachable power cord that is supplied with the instrument plugs into this socket. The other end of the detachable power cord plugs into the local mains supply. Use only the cable supplied with the instrument. The mains supply must be earthed, and the cord used to connect the instrument to the mains supply must provide an earth connection. (The supplied cord does this.)

 **Warning:** Failure to use a grounded outlet may result in injury or death due to electric shock. This product uses a power cord with a ground connection. It must be connected to a properly grounded outlet. The instrument chassis is connected to the ground wire in the power cord.

The table below describes the power cord that is normally supplied with this instrument, depending on the destination region:

Destination Region	Description	Option	Manufacturer	Part Number
United Kingdom, Hong Kong, Singapore, Malaysia	BS 1363, 230V, 50 Hz	-AC00	Qualtek	370001-E01
Australia, New Zealand	AS 3112:2000, 230-240V, 50 Hz	-AC01	Qualtek	374003-A01
Continental Europe, Korea, Indonesia, Russia	European CEE 7/7 "Schuko" 230V, 50 Hz	-AC02	Qualtek	364002-D01
North America, Taiwan	NEMA 5-15, 120V, 60 Hz	-AC03	Qualtek	312007-01
Switzerland	SEV 1011, 230V, 50 Hz	-AC06	Qualtek	378001-E01
South Africa, India	SABS 164-1, 220-250V, 50 Hz	-AC17	Volex	2131H 10 C3
Japan	JIS 8303, 100V, 50-60 Hz	-AC18	Qualtek	397002-01
Israel	SI 32, 220V, 50 Hz	-AC19	Qualtek	398001-01
China	GB 1002-1, 220V, 50 Hz	-AC22	Volex	2137H 10 C3

PROTECTION FROM ELECTRIC SHOCK

 Operators of this instrument must be protected from electric shock at all times. The owner must ensure that operators are prevented access and/or are insulated from every connection point. In some cases, connections must be exposed to potential human contact. Operators must be trained to protect themselves from the risk of electric shock. This instrument is intended for use by qualified personnel who recognize shock hazards and are familiar with safety precautions required to avoid possibly injury. In particular, operators should:

1. Keep exposed high-voltage wiring to an absolute minimum.
2. Wherever possible, use shielded connectors and cabling.
3. Connect and disconnect loads and cables only when the instrument is turned off.
4. Keep in mind that all cables, connectors, oscilloscope probes, and loads must have an appropriate voltage rating.

5. Do not attempt any repairs on the instrument, beyond the fuse replacement procedures described in this manual. Contact Avtech technical support (see page 2 for contact information) if the instrument requires servicing. Service is to be performed solely by qualified service personnel.

ENVIRONMENTAL CONDITIONS

This instrument is intended for use under the following conditions:

1. indoor use;
2. altitude up to 2 000 m;
3. temperature 5 °C to 40 °C;
4. maximum relative humidity 80 % for temperatures up to 31 °C decreasing linearly to 50 % relative humidity at 40 °C;
5. Mains supply voltage fluctuations up to ± 10 % of the nominal voltage;
6. no pollution or only dry, non-conductive pollution.

FUSES

This instrument contains four fuses. All are accessible from the rear-panel. Two protect the AC prime power input, and two protect the internal DC power supplies. The locations of the fuses on the rear panel are shown in the figure below:



AC FUSE REPLACEMENT

To physically access the AC fuses, the power cord must be detached from the rear panel of the instrument. The fuse drawer may then be extracted using a small flat-head screwdriver, as shown below:



DC FUSE REPLACEMENT

The DC fuses may be replaced by inserting the tip of a flat-head screwdriver into the fuse holder slot, and rotating the slot counter-clockwise. The fuse and its carrier will then pop out.

FUSE RATINGS

The following table lists the required fuses:

Fuses	Nominal Mains Voltage	Rating	Case Size	Recommended Replacement Part	
				Littelfuse Part Number	Digi-Key Stock Number
#1, #2 (AC)	100-240V	0.5A, 250V, Time-Delay	5×20 mm	0218.500HXP	F2416-ND
#3 (DC)	N/A	1.6A, 250V, Time-Delay	5×20 mm	021801.6HXP	F2424-ND
#4 (DC)	N/A	0.5A, 250V, Time-Delay	5×20 mm	0218.500HXP	F2416-ND

The recommended fuse manufacturer is Littelfuse (<http://www.littelfuse.com>).

Replacement fuses may be easily obtained from Digi-Key (<http://www.digikey.com>) and other distributors.

FRONT PANEL CONTROLS

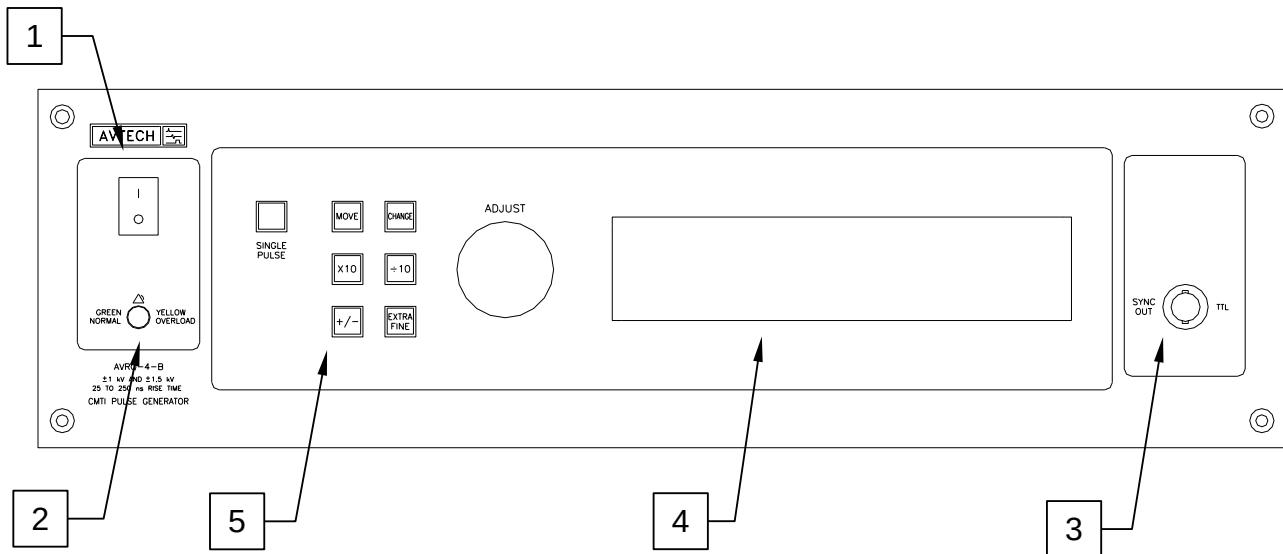

1. **POWER Switch.** This is the main power switch. When turning the instrument on, there is normally a delay of 10 seconds before anything is shown on the main display, as the internal operating system boots up.

If the main menu does not appear after 30 seconds, turn off the instrument and leave it off for at least 60 seconds before applying power again.

2. **OVERLOAD Indicator.** When the instrument is powered, this indicator is normally green, indicating normal operation. If this indicator is yellow, an internal automatic overload protection circuit has been tripped. If the unit is overloaded (by operating at an exceedingly high duty cycle or by operating into a very low impedance), the protective circuit will disable the output of the instrument and turn the indicator light yellow. The light will stay yellow (i.e. output disabled) for about 5 seconds after which the instrument will attempt to re-enable the output (i.e. light green) for about 1 second. If the overload condition persists, the output will be disabled again (i.e. light yellow) for another 5 seconds. If the overload condition has been removed, the instrument will resume normal operation.

This overload indicator may flash yellow briefly at start-up. This is not a cause for concern.

3. **SYNC OUT.** This connector supplies a SYNC output that can be used to trigger other equipment, particularly oscilloscopes. This signal leads (or lags) the main output by a duration set by the "DELAY" controls and has an approximate amplitude of +3 Volts to $R_L > 1\text{ k}\Omega$ with a pulse width of approximately 100 ns.
4. **LIQUID CRYSTAL DISPLAY (LCD).** This LCD is used in conjunction with the keypad to change the instrument settings. Normally, the main menu is displayed,

which lists the key adjustable parameters and their current values. The “Programming Manual for -B Instruments” describes the menus and submenus in detail.

5. KEYPAD.

Control Name	Function
MOVE	This moves the arrow pointer on the display.
CHANGE	This is used to enter the submenu, or to select the operating mode, pointed to by the arrow pointer.
×10	If one of the adjustable numeric parameters is displayed, this increases the setting by a factor of ten.
÷10	If one of the adjustable numeric parameters is displayed, this decreases the setting by a factor of ten.
+/-	If one of the adjustable numeric parameters is displayed, and this parameter can be both positive or negative, this changes the sign of the parameter.
EXTRA FINE	This changes the step size of the ADJUST knob. In the extra-fine mode, the step size is twenty times finer than in the normal mode. This button switches between the two step sizes.
ADJUST	This large knob adjusts the value of any displayed numeric adjustable values, such as frequency, pulse width, etc. The adjust step size is set by the "EXTRA FINE" button. When the main menu is displayed, this knob can be used to move the arrow pointer.

REAR PANEL CONTROLS

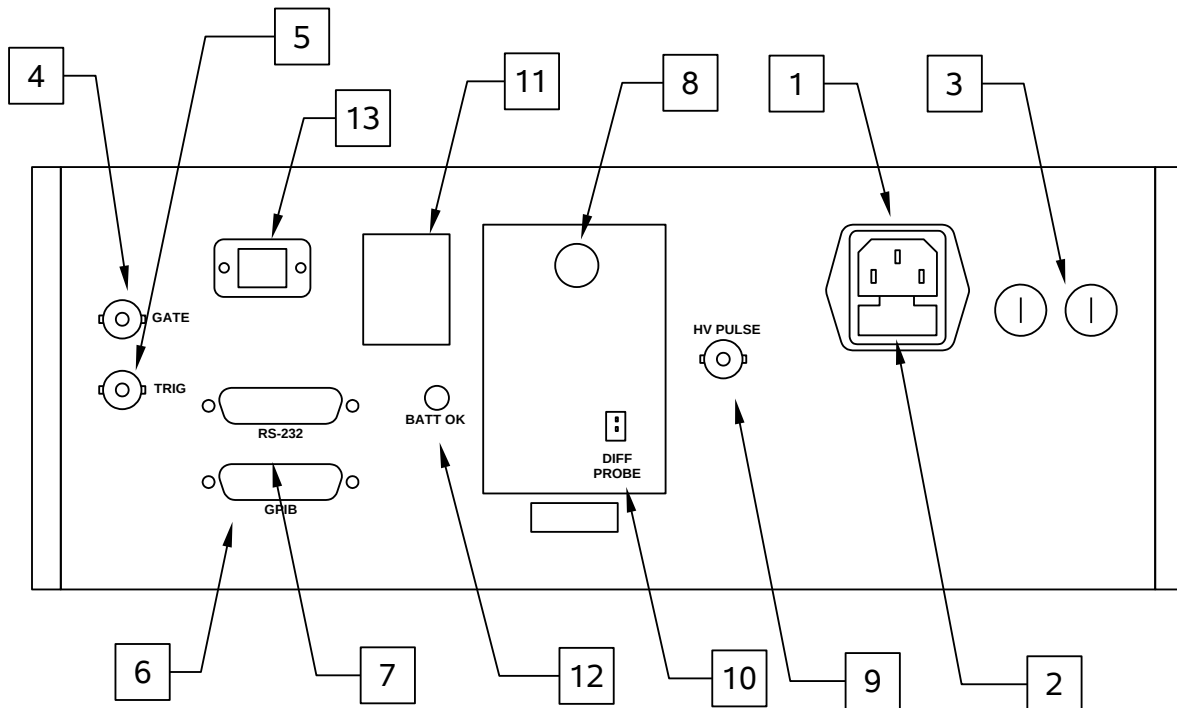

1. AC POWER INPUT. An IEC-320 C14 three-pronged recessed male socket is provided on the back panel for AC power connection to the instrument. One end of the detachable power cord that is supplied with the instrument plugs into this socket.
2. AC FUSE DRAWER. The two fuses that protect the AC input are located in this drawer. Please see the “FUSES” section of this manual for more information.
3. DC FUSES. These two fuses protect the internal DC power supplies. Please see the “FUSES” sections of this manual for more information.
4. GATE. This TTL-level (0 and +5V) logic input can be used to gate the triggering of the instrument. This input can be either active high or active low, depending on the front panel settings or programming commands. (The instrument triggers normally when this input is unconnected). When set to active high mode, this input is pulled-down to ground by a 1 k Ω resistor. When set to active low mode, this input is pulled-up to +5V by a 1 k Ω resistor.
5. TRIG. This TTL-level (0 and +5V) logic input can be used to trigger the instrument, if the instrument is set to triggering externally. The instrument triggers on the rising edge of this input. The input impedance of this input is 1 k Ω . (Depending on the length of cable attached to this input, and the source driving it, it may be desirable to add a coaxial 50 Ohm terminator to this input to provide a proper transmission line termination. The Pasternack (www.pasternack.com) PE6008-50 BNC feed-thru 50

Ohm terminator is suggested for this purpose.)

6. GPIB Connector. A standard GPIB cable can be attached to this connector to allow the instrument to be computer-controlled. See the “Programming Manual for -B Instruments” for more details on GPIB control.
7. RS-232 Connector. A standard serial cable with a 25-pin male connector can be attached to this connector to allow the instrument to be computer-controlled. A user name (“admin”) and a password (“default”, as shipped from the factory) are required when logging into a serial terminal session. The internal controller attempts to auto-sense the parity setting. It may be necessary to send a few return characters before attempting a login in order to provide enough data to allow this auto-sensing to work. (A standard Linux “agetty” process is used to implement serial control internally.) See the “Programming Manual for -B Instruments” for more details on RS-232 control.
8. DUT Door. This is the door that provides access to the DUT socket. To open it, pull on the chrome knob. When closed, the door is held latched in place magnetically.

The high voltage output is automatically disabled when the DUT door is opened. The door must be closed during tests.

The layout of the DUT socket is discussed in the “DUT Socket” section.

9. HV PULSE CONNECTOR. The BNC connector provides access to the high voltage (± 1 kV or ± 1.5 kV) pulse that is applied to the DUT, for monitoring purposes. This signal must be observed on an oscilloscope to accurately measure the dV/dt rate of the high voltage pulse.

A Tektronix P5100 high-voltage probe with the 013-0291-00 probe-tip-to-BNC adapter should be used to connect to this output.

 CAUTION: Voltages as high as 1.5 kV may be present on the center conductor of this output connector. Avoid touching this conductor. Connect to this connector using a Tektronix P5100 high-voltage probe with the 013-0291-00 probe-tip-to-BNC adapter, to ensure that the center conductor is not exposed.

 DO NOT CONNECT THIS OUTPUT DIRECTLY TO AN OSCILLOSCOPE. The oscilloscope will be damaged by the high voltages. Use a Tektronix P5100 high-voltage probe with the 013-0291-00 probe-tip-to-BNC adapter.

 DO NOT CONNECT COAXIAL CABLING TO THIS OUTPUT. The capacitance of the cabling will reduce the dV/dt rates noticeably.

10. DIFF OUT Connector. This two-pin header connector connects internally to the logic output of the DUT (and the associated ground). This is the output that is monitored for “glitches” caused by high dV/dt rates on the common mode voltage. It will mate to the Tektronix P6246 differential probe, or to standard 0.1” header sockets. When using the

differential probe, install the probe so that the “-” side is on the top, and the “+” side is on the bottom. A differential probe is used to help eliminate noise coupled from the high-voltage signals. Please note that the Tektronix P6246 has a limited voltage range, and may not be suitable for use with units with the -SCHB option. The -SCHB option permits logic outputs as high as 43V.

11. 9V BATTERY. A 9V battery is used to power the floating side of the opto-coupler. The battery must be installed in this drawer. The drawer is designed to only accept the battery if it is oriented correctly. The internal circuit will not be damaged by a reversed diode. Do not replace the battery while the instrument is powered on.
12. BATT OK INDICATOR. When the AVRQ-4-B is turned on, this indicator should be green. If it is not, turn off the instrument and replace the battery.
13. Network Connector. (Optional feature. Active on -VXI units only.) This Ethernet connector allows the instrument to be remotely controlled using the VXI-11.3, ssh (secure shell), telnet, and http (web) protocols. See the “Programming Manual for -B Instruments” for more details.

GENERAL INFORMATION

BASIC PULSE CONTROL

This instrument can be triggered by its own internal clock or by an external TTL trigger signal. In either case, two output channels respond to the trigger: HV PULSE and SYNC. The HV PULSE channel is the signal that is applied to the DUT. Its amplitude is variable. The SYNC pulse is a fixed-width TTL-level reference pulse used to trigger oscilloscopes or other measurement systems. When the delay is set to a positive value the SYNC pulse precedes the HV PULSE pulse. When the delay is set to a negative value the SYNC pulse follows the HV PULSE pulse.

These pulses are illustrated below, assuming internal triggering, a positive delay, and positive amplitude:

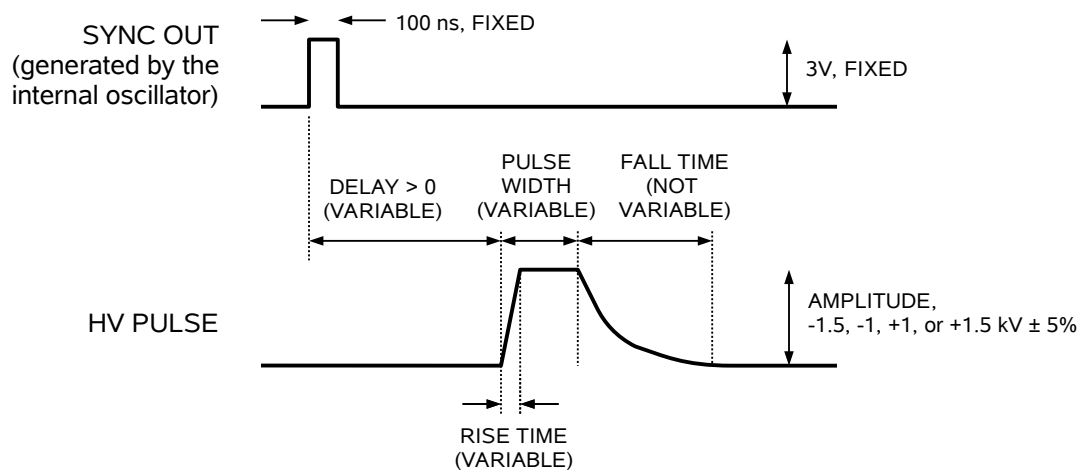

If the delay is negative, the order of the SYNC and OUT pulses is reversed:

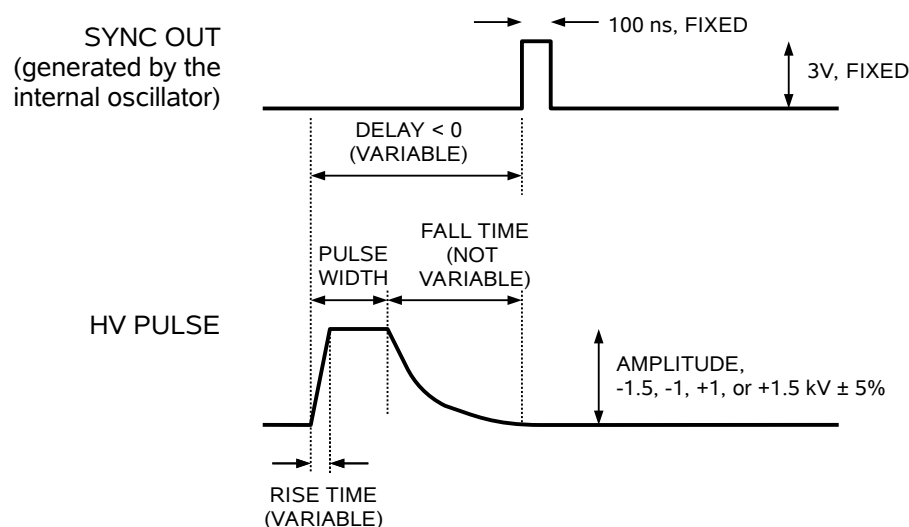

The next figure illustrates the relationship between the signals when an external TTL-level trigger is used:

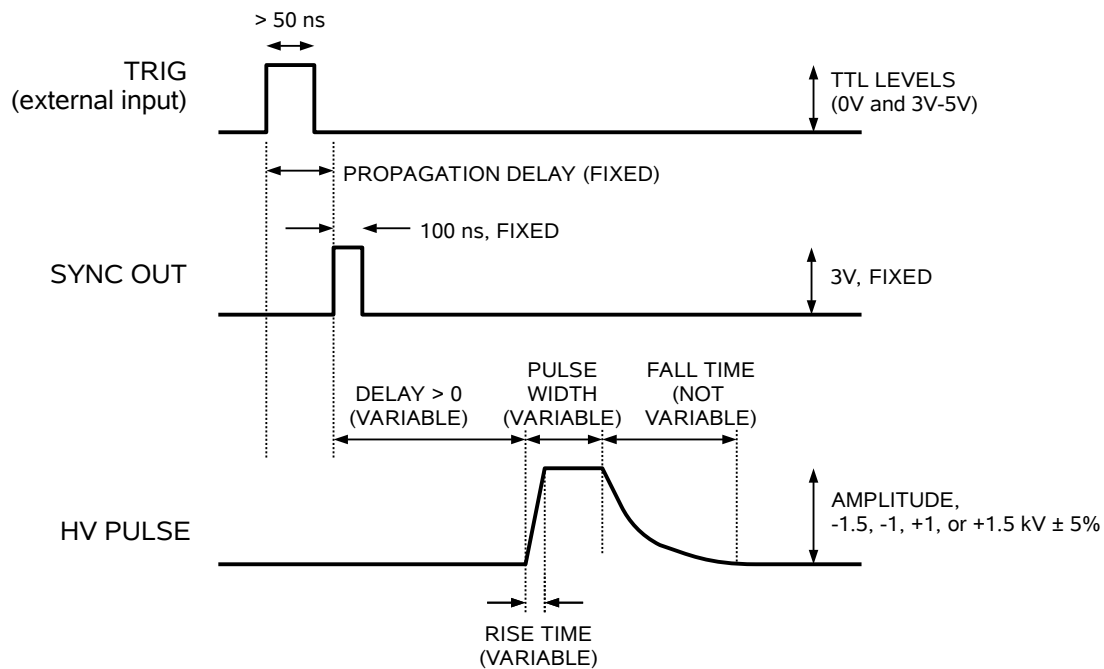

As before, if the delay is negative, the order of the SYNC and OUT pulses is reversed.

The delay, pulse width, and frequency (when in the internal mode), of the OUT pulse can be varied with front panel controls or via the GPIB or RS-232 computer interfaces.

TRIGGER MODES

This instrument has four trigger modes:

- Internal Trigger: the instrument controls the trigger frequency, and generates the clock internally.
- External Trigger: the instrument is triggered by an external TTL-level clock on the back-panel TRIG connector.
- Manual Trigger: the instrument is triggered by the front-panel "SINGLE PULSE" pushbutton.
- Hold Trigger: the instrument is set to not trigger at all.

These modes can be selected using the front panel trigger menu, or by using the appropriate programming commands. (See the “Programming Manual for -B Instruments” for more details.)

GATING MODES

Triggering can be suppressed by a TTL-level signal on the rear-panel GATE connector. The instrument can be set to stop triggering when this input high or low, using the front-panel gate menu or the appropriate programming commands. This input can also be set to act synchronously or asynchronously. When set to asynchronous mode, the GATE will disable the output immediately. Output pulses may be truncated. When set to synchronous mode, the output will complete the full pulse width if the output is high, and then stop triggering. No pulses are truncated in this mode.

DUT INSTALLATION

PIN SOCKET PINOUT

The AVRQ-4-B provides a daughterboard arrangement for the user's opto-couplers. The high-voltage pulse is applied between the floating ground on the input side (GND1) and the chassis-ground on the output side (GND2). A user-supplied 9V battery is installed to provide a floating regulated 5V power source (VCC1), which may be used to power a voltage-drive device directly, or it may be connected through a series resistance to drive current-biased devices. A chassis-ground-referenced power supply (VCC2) is provided on the output side, and is adjustable from +3V to +8V (or up to +43V, with the -SCHB option).

The AVRQ-4-B provides a pattern of pin sockets into which a daughterboard may be plugged. The (simplified) circuit diagram of the pin sockets arrangement is shown below. The user's daughterboard should only connect electrically to the VCC1, VCC2, GND1, and GND2 pin sockets. The other pin sockets are for physical support.

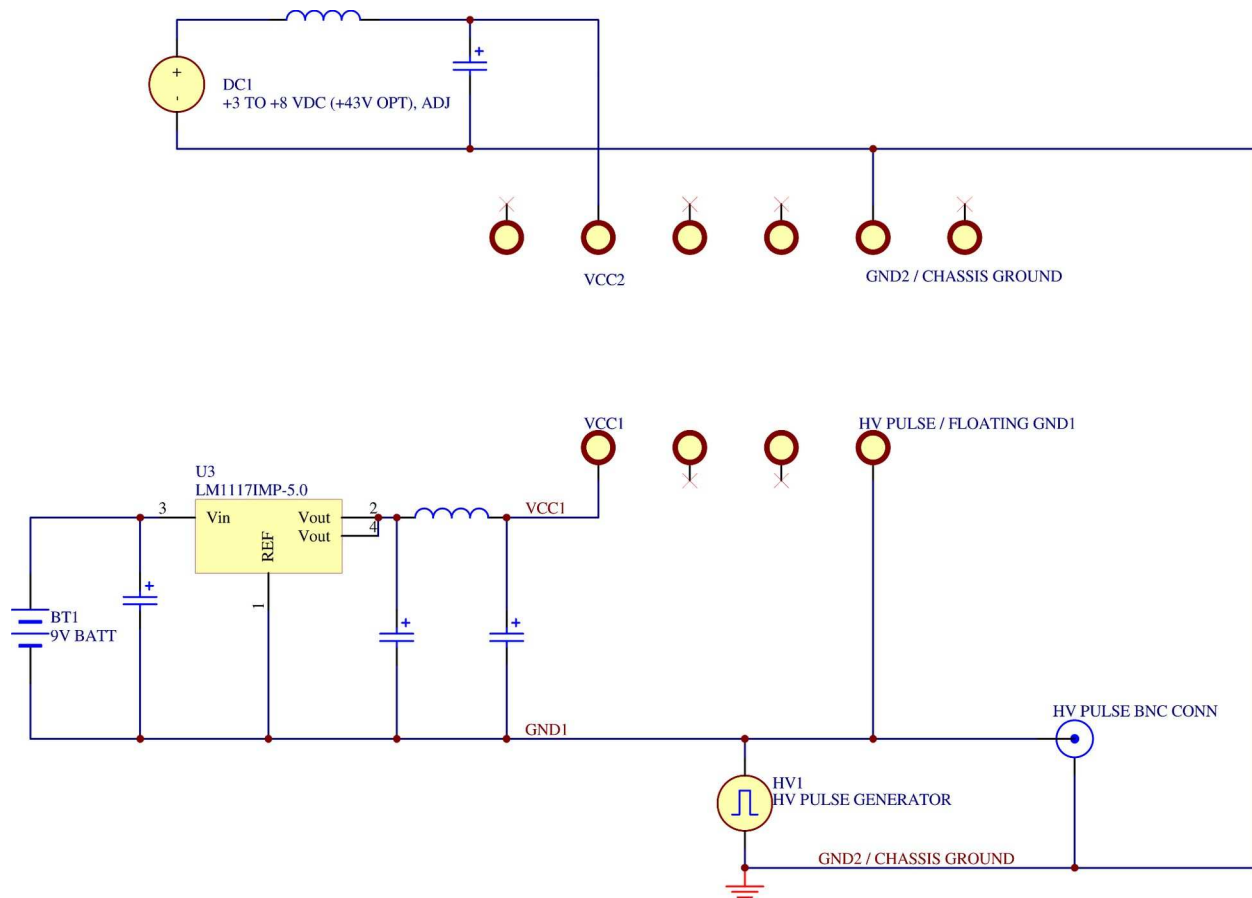

A more detailed schematic is included in the “FLOATING +5V AND DUT WIRING, ON MAIN PCB” section of the manual.

SAMPLE DAUGHTERBOARD WIRING

The schematic for the sample daughterboards included with the AVRQ-4-B is shown below. It includes a number of configuration resistors and one configuration capacitor.

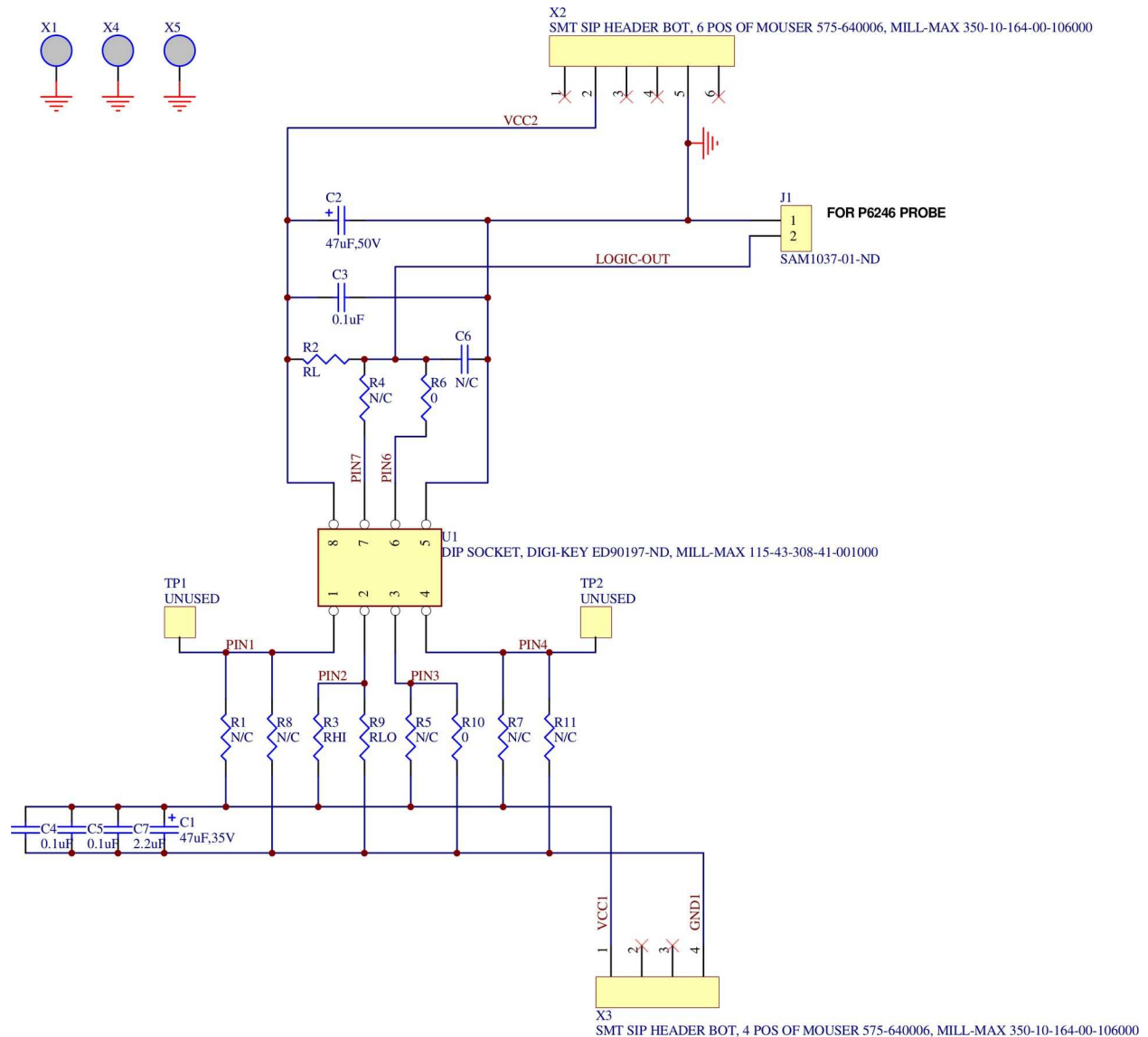

Any of pins 1 to 4 may be connected directly to VCC1 or GND1 use a zero-ohm jumper in the appropriate location. For example, a voltage-powered device would normally install R1=0 (to connect VCC1 to pin 1) and R11=0 (to connect GND1 to pin 4). The logic inputs (on pins 2 and 3) would then be connected to VCC1 or GND1 as desired using R3, R9, R5, and/or R10.

Pin 5 is hard-wired to GND2. Pin 8 is hard-wired to VCC2.

The logic output can be taken from pin 6 or pin 7, by installing a zero-ohm jumper in R6 or R4. A pull-up resistance to VCC2 may be installed (R2). A capacitance to ground may be installed on the logic output, if desired, using C6.

SAMPLE DAUGHTERBOARD – PIN 7 ISSUES

 Some opto-coupler devices provide access to the photo-transistor base on pin 7. In these devices, pin 7 is extremely sensitive to interference - in particular, capacitive coupling of the high-voltage pulse.

The supplied daughterboard is a realistic environment for tests.

 However, better results may be obtained under some conditions if the user drills out the pin 7 position from the DIP socket and PCB.

SAMPLE DAUGHTERBOARD – SOCKETING ISSUES

 All sockets introduce unwanted parasitic capacitance. This can be particularly troublesome for devices with a photo-transistor base pin (pin 7 typically, as described above). The sockets used in the sample daughterboards are low-profile, low-capacitance DIP sockets.

To obtain the best possible results from sensitive devices, it may be advisable to make a special daughterboard with the DUT soldered directly onto it (i.e., with no sockets).

The spare unpopulated daughterboards included with the instrument may be used for this purpose, or the user may design their own daughterboard.

This is probably the only practical approach for testing SMT devices, as well.

SAMPLE DAUGHTERBOARD – DRIVER FILTERING ISSUES

 For situations where the optocoupler logic input is not connected to GND1, it may be advantageous to add some capacitive filtering on the input.

For example, if pin 2 is connected to VCC1 through resistor R3, the user could use the “R9” position to install a capacitor to GND1.

The degree of filtering, and whether it is used at all, may be dictated by the user's test requirements.

SAMPLE DAUGHTERBOARD – LOADING ISSUES

The optocoupler output may be “pulled-up” to VCC2 by installing a resistor in position R2. The value of the resistance is typically mandated by specific test standards.

⚠ A capacitance to ground may be installed on the logic output, if desired, using C6. This may provide better results under some conditions, particularly since it will act to reduce parasitic voltages coupled from the high-voltage pulse. The degree of capacitance, and whether it is used at all, may be dictated by the user's test requirements.

SAMPLE DAUGHTERBOARD – PIN STRIPS

The bottom side of each populated daughterboard has two pin strips, one with 4 positions and one with 6. These pins may break after heavy use. A replacement breakaway strip is provided with the instrument. Replacement strips are available from Mill-Max (P/N 350-10-164-00-106000, also available from Mouser, stock number 575-640006).

SO-8 DAUGHTERBOARDS

Units ordered with the -SO8 option are provided with 32 extra daughterboards (PCB 263A). These boards have the same electrical configuration as the standard sample daughterboards described above, except that an SO-8 footprint is provided instead of a DIP-8 socket.

The DUT must be soldered to the daughterboard. A socket is not practical for SO-8 tests, since the extra parasitic capacitance introduced by a socket would severely degrade the measured CMTI.

No configuration resistors are installed on the SO-8 daughterboards by default, to provide maximum flexibility for the user. Some resistors must be installed before they can be used for test purposes.

Avtech can provide Gerber and drill CAD files at no charge if the user wishes to produce additional quantities of these circuit boards.

OTHER DAUGHTERBOARDS

The sample daughterboards provided with the AVRQ-4-B are meant as samples.

The user may construct their own daughterboards, which may incorporate a preferred physical layout, different filtering circuits, or different DUT packages and socketing.

⚠ When designing your own daughterboard, take care to isolate the input and output sides as much as possible, to both provide sufficient high-voltage clearance and to minimize parasitic coupling of the HV pulse onto the output signal.

Gerber files for the sample daughterboards are available from Avtech at no charge (info@avtechpulse.com). These should be used as a basis for user-designed boards.

DIFFERENTIAL PROBING

The sample daughterboards provided by Avtech use a two-pin header to transmit the output waveform to a user-supplied Tektronix P6246 differential probe. The use of a differential probe helps reduce spurious transient signal artefacts on the oscilloscope, which are typically caused by ground bounce and interference in general.

When designing custom daughterboards, a similar approach should be used.

Please note that the Tektronix P6246 has a limited voltage range, and may not be suitable for use with units with the -SCHB option. The -SCHB option permits logic outputs as high as 43V.

SAMPLE DAUGHTERBOARD CONFIGURATIONS

12 populated sample daughterboards are provided with each AVRQ-4-B, along with 12 unpopulated spare boards. The 12 sample boards are configured as follows:

Type	Pin 7 Socketing	IF (mA)	RHI / R3 (Ω)	RLO / R9 (Ω)	RL / R2 (Ω)
A	Normal	0	UNUSED	0	348, 1%
B	Normal	0	UNUSED	0	1.91k, 1%
C	Normal	0	UNUSED	0	4.12k, 1%
D	Normal	7.5	470	UNUSED	348, 1%
E	Normal	16	220	UNUSED	1.91k, 1%
F	Normal	16	220	UNUSED	4.12k, 1%
A7	Drilled out	0	UNUSED	0	348, 1%
B7	Drilled out	0	UNUSED	0	1.91k, 1%
C7	Drilled out	0	UNUSED	0	4.12k, 1%
D7	Drilled out	7.5	470	UNUSED	348, 1%
E7	Drilled out	16	220	UNUSED	1.91k, 1%
F7	Drilled out	16	220	UNUSED	4.12k, 1%

The values of R3 are calculated assuming a current-drive LED with a forward voltage drop of 1.5V. Thus, $(5V - 1.5V) / 470 \approx 7.5$ mA, and $(5V - 1.5V) / 220 \approx 16$ mA. The user is free to change these values as appropriate.

All configuration components used the standard “0805” footprint.

SO-8 daughterboards (for units with the -SO8 option) do not have any configuration resistors installed by default, to provide maximum flexibility for the user. Some resistors must be installed before they can be used for test purposes.

INSTALLING THE DAUGHTERBOARDS

To install a daughterboard, first turn off the instrument. (The instrument will disable the high-voltage circuitry automatically if the DUT door is opened, but it is better practice to turn off the instrument entirely.)

Install the DUT in the socket for it on the daughterboard.

Open the rear-panel DUT door. Using tweezers, carefully position the 10 pins on the bottom side of the daughterboard over the matching 10 pin sockets on the main instrument board. Gently press down on the daughterboard until it is firmly in the pin sockets.

The board may additionally be secured to the 3 metal posts on the main board using three 4-40 thumbscrews (Keystone Electronics part number 2400), although this is not normally necessary. The fit of the pins is usually enough to secure the daughterboard.

Closing the DUT door and turn on the instrument. Proceed with your tests.

When testing is finished, turn off the instrument, open the DUT door, and gently use tweezers to lift the daughterboard up out of the pin sockets, and out towards the rear. Take care to not bend the pins.

UNPOPULATED DAUGHTERBOARDS

Twelve unpopulated daughterboards are included with the instrument. Six (PCB 213B) have a standard pad for pin 7. Six (PCB 213B7) have the pad for pin 7 removed (drilled out).

BASIC TEST ARRANGEMENT

The figure below shows the basic test arrangement for the AVRQ-4-B, with one possible DUT daughterboard configuration:

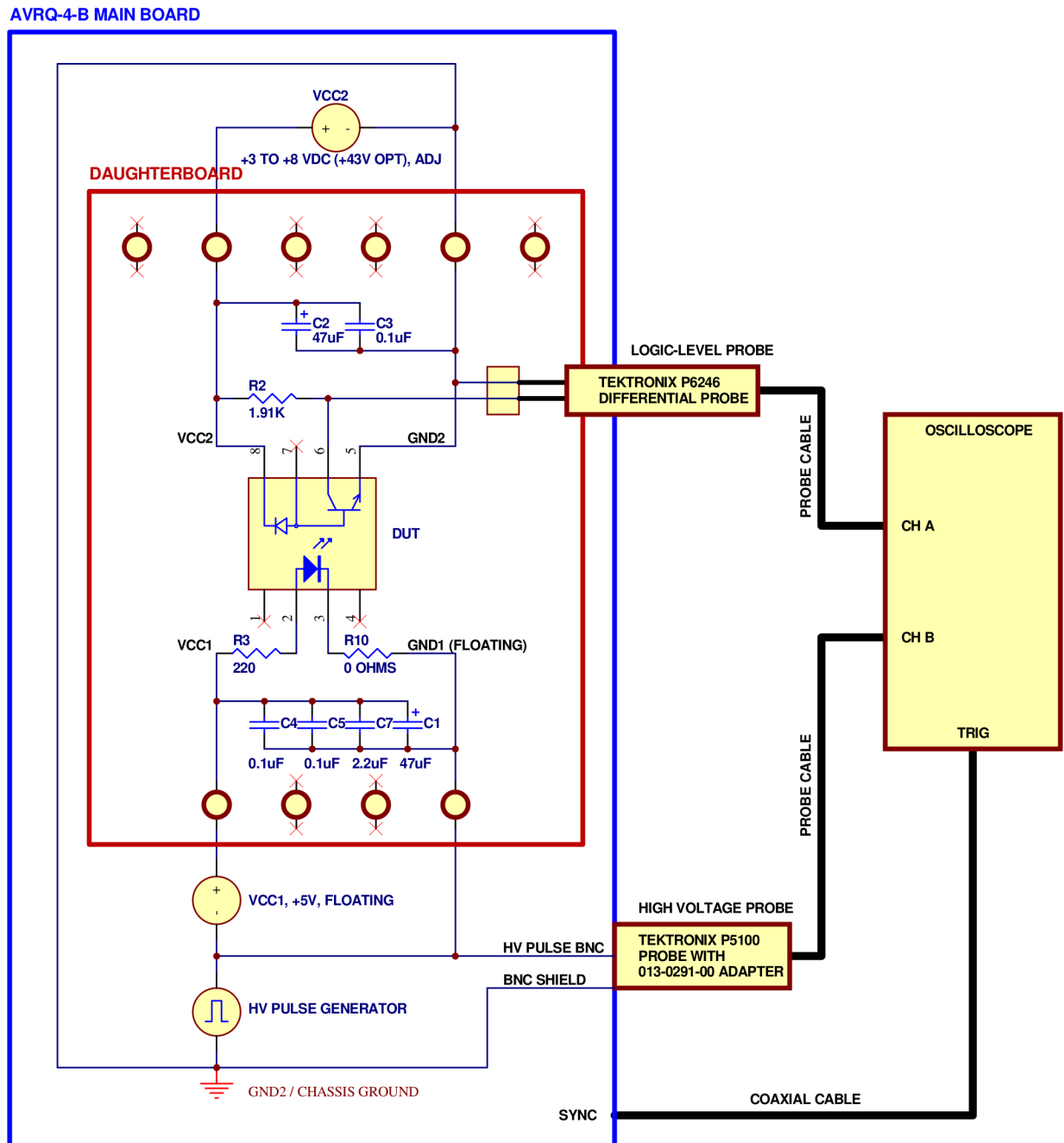

To connect the AVRQ-4-B properly, do the following:

- 1) With the power off, install an appropriately-configured daughterboard and DUT, as described in the previous section.
- 2) Connect the SYNC output (on the front panel) to the external trigger input of the oscilloscope using (user-supplied) coaxial cabling.
- 3) Connect the (user-supplied) Tektronix P5100 probe to the rear-panel HV PULSE connector using the (user-supplied) Tektronix 013-0291-00 probe-to-BNC adapter.
- 4) With the DUT door closed, gently insert the Tektronix P6246 differential probe to mate with the output header on the daughterboard. The “+” side of the probe should be down. Please note that the P6246 has a maximum differential input voltage range of 8.5V. If higher values of VCC2 will be used, a different probe will be required.
- 5) Power-up the AVRQ-4-B and the oscilloscope.

 Caution: The HV PULSE oscilloscope probe must be rated for operation at 1.5 kV (pulsed) or higher. Factory tests are conducted using a Tektronix P5100 probe, which has a 2.5 kV peak rating and a 1000:1 division ratio. (Remember to adjust the compensation of the probe to match your oscilloscope input.)

TYPICAL WAVEFORMS

BASIC THEORY

The user will install a DUT on a daughterboard. The daughterboard configuration determines the input bias to the opto-coupler, as well as the output loading.

The AVRQ-4-B settings control the amplitude of the HV pulse (-1.5 kV, -1.0 kV, +1.0 kV, or +1.5 kV), the rise time of this HV pulse, and the DC voltage applied to VCC2 (+3 to +8V, adjustable, or up to +43V, with the -SCHB option). The floating DC voltage applied to VCC1 is fixed at +5V.

For example, the HV pulse might be set to a positive amplitude (+1 kV or +1.5 kV), with the input anode and cathode both connected to GND1 (zero current bias). In this mode, the output voltage should be pulled-up to VCC2. However, as the rise time of the HV pulse is reduced, the interference caused by the fast pulse may cause a “glitch” to appear on the output, where the output changes state (or come close to it). This is illustrated below:

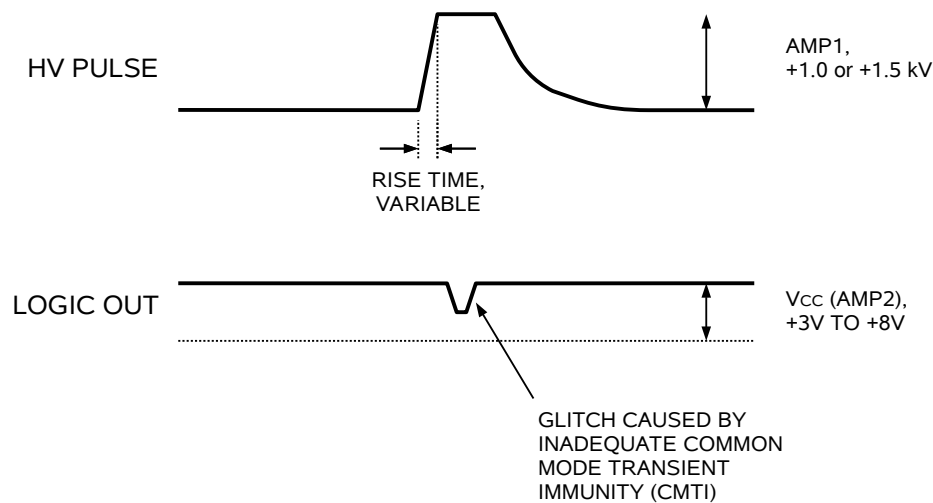

The next illustration shows a similar glitch occurring for a negative high-voltage pulse, where the input has been biased “on” to provide a normally-zero output voltage:

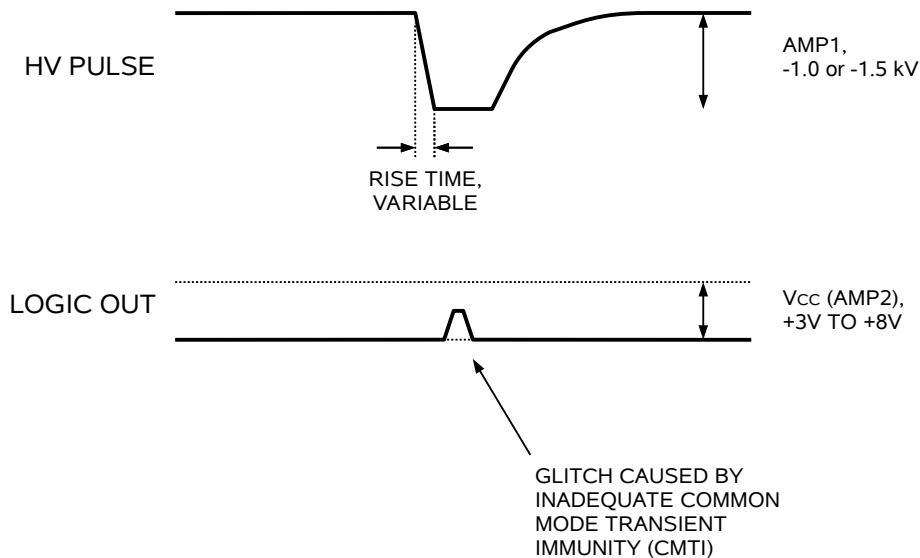

TYPICAL RESULTS, "A" DAUGHTERBOARD

For the following test results the "A" daughterboard was used (so the input bias current was zero, and the output pullup resistor was 348 Ohms), with a -1 kV pulse amplitude and a VCC2 of +5.0V. In all cases, the rise time was reduced until a glitch of 50% of VCC2 was observed, if possible.

TRW 6N137, "A" DAUGHTERBOARD

Using an old TRW 6N137 (datecode 8642) device as the DUT, a glitch equal to 50% of VCC2 first occurred at a measured fall time of 57.34 ns. This corresponds to a dV/dt of $1 \text{ kV} \times (90\% - 10\%) / 57.34 \text{ ns} = 14.0 \text{ kV}/\mu\text{s}$.

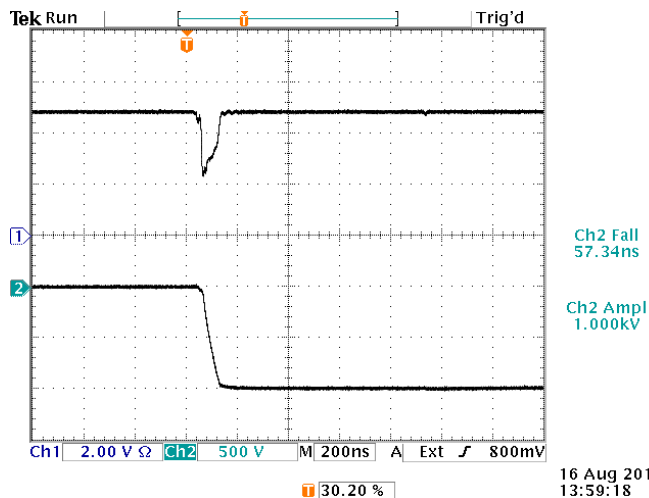

HP HCPL-2601, "A" DAUGHTERBOARD

Using a Hewlett-Packard HCPL-2601 (datecode 9205) device as the DUT, it was not possible to induce a glitch greater than 50% of VCC2. A smaller glitch was noted at the minimum rise time. This corresponds to a dV/dt rating of at least $1 \text{ kV} \times (90\% - 10\%) / 18.62 \text{ ns} = 43.0 \text{ kV/us}$.

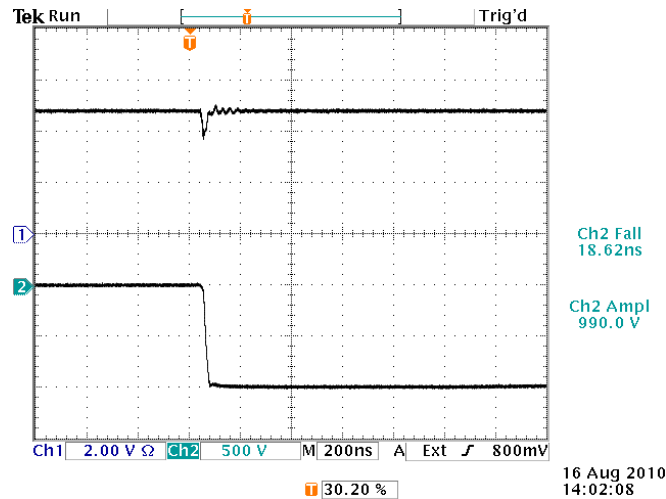

QTC HCPL-2601, "A" DAUGHTERBOARD

The QTC HCPL-2601 is nominally equivalent to the HP HCPL-2601. Using the QTC HCPL-2601 (datecode 9522) device as the DUT, a glitch equal to 50% of VCC2 first occurred at a measured fall time of 67.66 ns. This corresponds to a dV/dt of $1 \text{ kV} \times (90\% - 10\%) / 67.66 \text{ ns} = 11.8 \text{ kV/us}$.

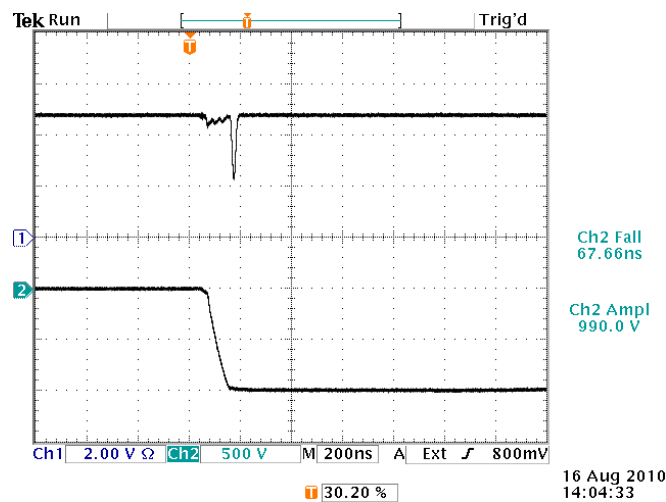

SAMPLE 5, "A" DAUGHTERBOARD

Using a customer-provided "sample 5" device as the DUT, it was not possible to induce a glitch greater than 50% of VCC2. A smaller glitch was noted at the minimum rise time. This corresponds to a dV/dt rating of at least $1 \text{ kV} \times (90\% - 10\%) / 18.83 \text{ ns} = 42.5 \text{ kV/us}$.

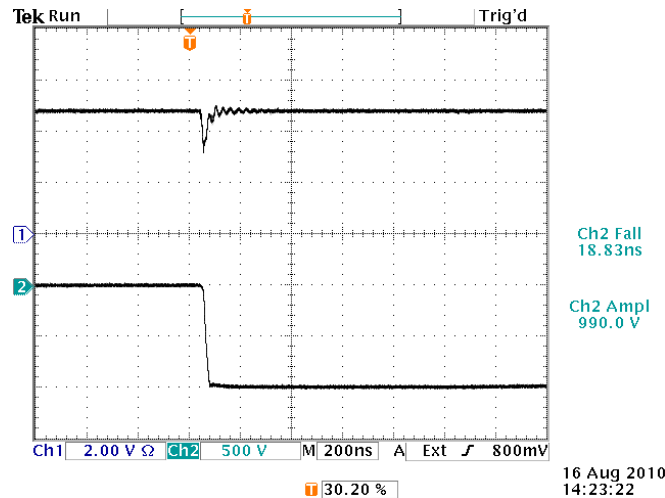

TYPICAL RESULTS, "D" DAUGHTERBOARD

For the following test results the "D" daughterboard was used (so the input bias current was 7.5 mA, and the output pullup resistor was 348 Ohms), with a -1.5 kV pulse amplitude and a VCC2 of +5.0V. In all cases, the rise time was reduced until a glitch of 50% of VCC2 was observed, if possible.

HP HCPL-2601, "D" DAUGHTERBOARD

Using a Hewlett-Packard HCPL-2601 (datecode 9205) device as the DUT, a glitch equal to 50% of VCC2 first occurred at a measured fall time of 136.6 ns. This corresponds to a dV/dt of $1.5 \text{ kV} \times (90\% - 10\%) / 136.6 \text{ ns} = 8.8 \text{ kV/us}$.

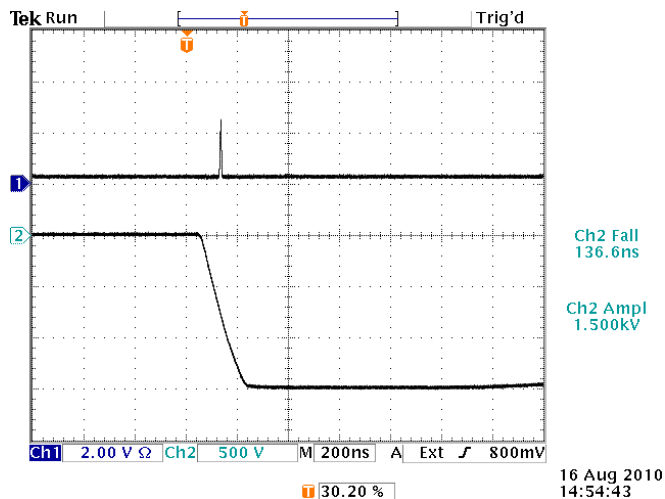

QTC HCPL-2601, "D" DAUGHTERBOARD

The QTC HCPL-2601 is nominally equivalent to the HP HCPL-2601. Using the QTC HCPL-2601 (datecode 9522) device as the DUT, a glitch equal to 50% of VCC2 first occurred at a measured fall time of 84.46 ns. This corresponds to a dV/dt of $1.5 \text{ kV} \times (90\% - 10\%) / 84.46 \text{ ns} = 14.2 \text{ kV/us}$.

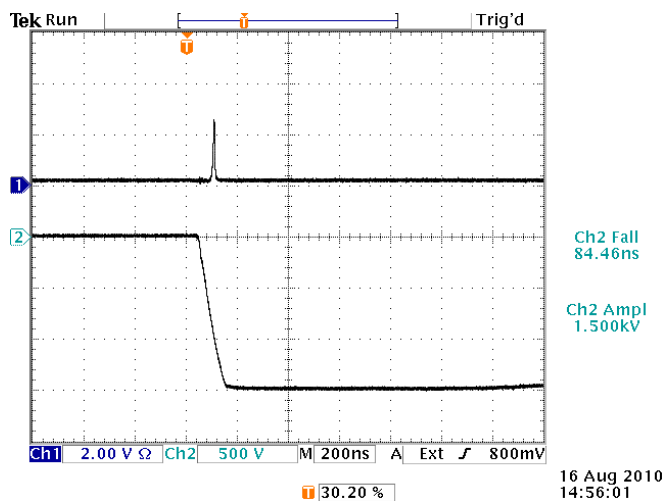

SAMPLE 1, "D" DAUGHTERBOARD

Using a customer-provided "sample 1" device as the DUT, a glitch equal to 50% of VCC2 first occurred at a measured fall time of 93.3 ns. This corresponds to a dV/dt of $1.5 \text{ kV} \times (90\% - 10\%) / 93.3 \text{ ns} = 12.9 \text{ kV/us}$.

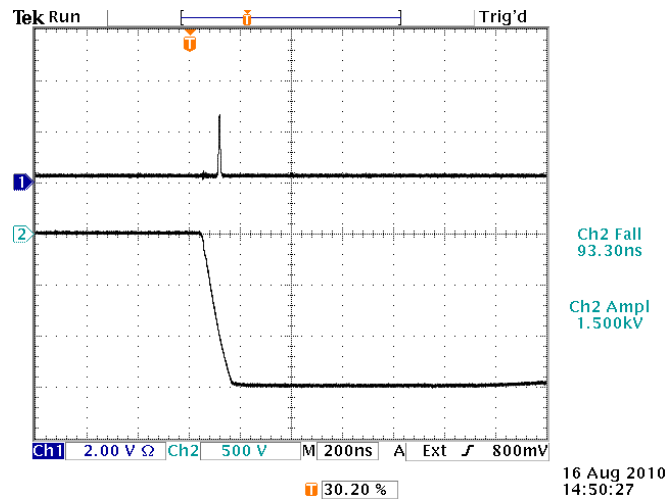

SAMPLE 1, "D7" DAUGHTERBOARD

The customer-provided "sample 1" device was found to be sensitive to interference on its pin 7. As such, it was tested again in the "D7" daughterboard, which has the pin socket for pin 7 drilled out. Under these conditions, a glitch equal to 50% of VCC2 first occurred at a measured fall time of 53.57 ns. This corresponds to a dV/dt of $1.5 \text{ kV} \times (90\% - 10\%) / 53.57 \text{ ns} = 22.4 \text{ kV/us}$.

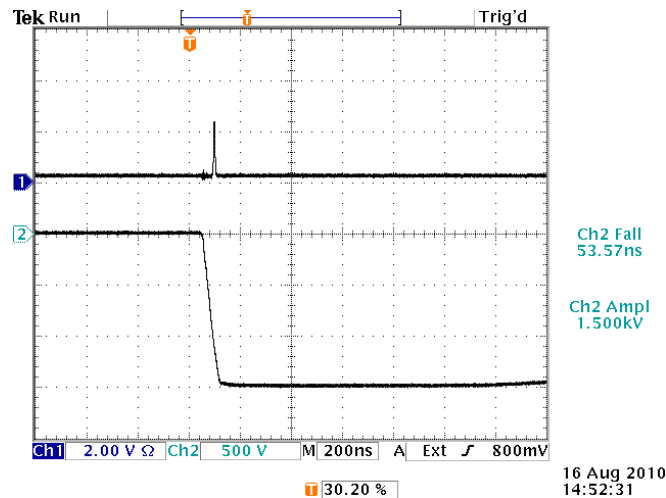

Removing the pin socket for pin 7, thus reducing stray capacitance, is enough to almost double the observed dV/dt rating.

VERIFICATION AND TROUBLESHOOTING

It is sometimes unclear whether the glitches observed on the opto-coupler output are due to the opto-coupler or the test circuit.

To reduce the number of sources of possible interference or error, a daughterboard scheme is used. This allows the drive conditions and the loading to be defined by simple, compact circuits that are user-visible and user-changeable.

Similarly, the floating-side power or bias is derived from a simple battery circuit, whose schematic is included in the schematics section of this manual. A more exotic switching non-battery-based power supply design has been avoided, to minimize complexity.

The input bias circuitry is always “on” when the instrument is powered on. The high-voltage circuits are only on when the instrument is powered on AND the DUT door is closed AND the output has been set to the “on” state. This allows the bias conditions to be measured in situ with the DUT door open. For example, for current-drive devices with non-zero bias levels, the current can be measured using compact DMM probes across resistor R3.

 It is NOT possible to measure the drive current or voltage on the floating input side while the high voltage pulse is active. It is dangerous, and it does not work anyway.

 High-voltage differential probes DO NOT accurately reproduce signals if an extremely fast high-voltage common mode signal is present.

 Using two probes and performing oscilloscope-based mathematics to calculate a difference is NOT accurate enough to measure a ~1V differential signal in the presence of a ~ 1 kV common mode signal.

If there is doubt about the stability of a non-zero drive signal, try soldering large capacitances across the drive pins of the input to see if that stabilizes anything (taking care to keep the capacitances away from the non-floating circuitry, for safety and interference reasons). If there is no change, that would tend to eliminate the drive signal as a source of problems.

If there is doubt about the stability of a zero-level drive signal, try soldering together the two drive pins directly on the IC package (i.e., short them out), to see if that stabilizes anything. If there is no change, that would tend to eliminate the drive signal as a source of problems.

Some devices are simply very sensitive to ANY stray capacitance between the input and output sides. As mentioned earlier, some devices are extremely sensitive to interference coupled to pin 7, which (unwisely) provides a connection to the photo-transistor base. To test this as a possible problem source, try snipping off pin 7 on your device and see if that affects the results beneficially. If it does, you might want to

consider designing your own ultra-low-stray-capacitance socket and daughterboard, or avoiding sockets entirely and using soldered devices instead.

SAFETY CONCERNS

TURN OUTPUT OFF BEFORE ACCESSING DUT

Always turn the output off before opening the rear-panel DUT door, using the front panel menu or by computer command (“output off”).

If you do not disable the output first, the output will be automatically disabled by a sensor on the DUT door when it is opened. However, the user should not rely on this for safety purposes.

Always check that the front panel indicates that the output is “off” before touching the DUT area.

For maximum safety, turn off the instrument before accessing the DUT area.

AUTOMATIC TIMEOUT

The output is disabled automatically after 90 seconds of inactivity (i.e., unchanged pulse settings). The timer resets each time a pulse parameter (amplitude, rise time, etc) is changed.

OVERLOAD INDICATOR

The front-panel “overload” indicator should always glow green, and never amber (except briefly when the instrument is first turned on).

If the overload indicator becomes active (amber), stop using the instrument immediately.

OPERATIONAL CHECK

This section describes a sequence to confirm the basic operation of the instrument. It should be performed after receiving the instrument. It is a useful learning exercise as well.

Before proceeding with this procedure, finish reading this instruction manual thoroughly. Then read the “Local Control” section of the “Programming Manual for -B Instruments” thoroughly. The “Local Control” section describes the front panel controls used in this operational check - in particular, the MOVE, CHANGE, and ADJUST controls.

1. Connect the pulser, the load, and the oscilloscope as described in the preceding “Basic Test Arrangement” section. Install a DUT.

 Confirm that the scope probe, test load, cables, and any adapters used are rated for 1.5 kV pulsed operation.

2. Turn on the AVRQ-4-B. The main menu will appear on the LCD.
3. To set the AVRQ-4-B to trigger from the internal clock at a PRF of 10 Hz:
 - a) The arrow pointer should be pointing at the frequency menu item. If it is not, press the MOVE button until it is.
 - b) Press the CHANGE button. The frequency submenu will appear. Rotate the ADJUST knob until the frequency is set at 10 Hz.
 - c) The arrow pointer should be pointing at the “Internal” choice. If it is not, press MOVE until it is.
 - d) Press CHANGE to return to the main menu.
4. To set the delay to 50 ns:
 - a) Press the MOVE button until the arrow pointer is pointing at the delay menu item.
 - b) Press the CHANGE button. The delay submenu will appear. Rotate the ADJUST knob until the delay is set at 50 ns.
 - c) The arrow pointer should be pointing at the “Normal” choice. If it is not, press MOVE until it is.
 - d) Press CHANGE to return to the main menu.

5. To set the rise time to 100 ns:
 - a) Press the MOVE button until the arrow pointer is pointing at the rise time menu item.
 - b) Press the CHANGE button. The rise time submenu will appear. Rotate the ADJUST knob until the rise time is set at 100 ns.
 - c) Press CHANGE to return to the main menu.
6. To set the HV PULSE amplitude to +1.5 kV:
 - a) Press the MOVE button until the arrow pointer is pointing at the AMP1 menu item.
 - b) Press the CHANGE button. The submenu will appear. Rotate the ADJUST knob until the amplitude is set at +1.5 kV.
 - c) Press CHANGE to return to the main menu.
7. To set the VCC2 amplitude to +5V:
 - a) Press the MOVE button until the arrow pointer is pointing at the AMP2 menu item.
 - b) Press the CHANGE button. The submenu will appear. Rotate the ADJUST knob until the amplitude is set at +5V.
 - c) Press CHANGE to return to the main menu.
8. At this point, nothing should appear on the oscilloscope.
9. To enable the output:
 - a) Press the MOVE button until the arrow pointer is pointing at the output menu item.
 - b) Press the CHANGE button. The output submenu will appear.
 - c) Press MOVE until the arrow pointer is pointing at the "ON" choice.
 - d) Observe the oscilloscope. You should see +1.5 kV pulses with 100 ns rise time, approximately.
 - e) Press CHANGE to return to the main menu.

10. Try varying the rise time, by repeating step (5). As you rotate the ADJUST knob, the rise time on the oscilloscope will change.
11. 90 seconds after the last parameter change, the instrument will automatically shut the output off. Confirm that this occurs.

This completes the operational check.

PROTECTING YOUR INSTRUMENT

USE HIGH-VOLTAGE CABLES, CONNECTORS, AND PROBES

 Confirm that the scope probe, test load, cables, and any adapters used are rated for 2 kV pulsed operation.

SHORT-CIRCUIT PROTECTION

The output will withstand temporary short-circuit conditions. However, short-circuit conditions should not be allowed to persist longer than 10 seconds, or the stress on the components will shorten the circuit lifetime.

MECHANICAL INFORMATION

TOP COVER REMOVAL

If necessary, the interior of the instrument may be accessed by removing the four Phillips screws on the top panel. With the four screws removed, the top cover may be slid back (and off).

 Always disconnect the power cord and allow the instrument to sit unpowered for 10 minutes before opening the instrument. This will allow any internal stored charge to discharge.

There are no user-adjustable internal circuits. For repairs other than fuse replacement, please contact Avtech (info@avtechpulse.com) to arrange for the instrument to be returned to the factory for repair.

 Caution: High voltages (over 1500V) are present inside the instrument during normal operation. Do not operate the instrument with the cover removed.

 Caution: Do not remove the internal aluminum lid. It shields certain very-high-voltage areas.

RACK MOUNTING

A rack mounting kit is available. The -R6 rack mount kit may be installed after first removing the one Phillips screw on the side panel adjacent to the front handle.

MAINTENANCE

REGULAR MAINTENANCE

This instrument does not require any regular maintenance.

On occasion, one or more of the four rear-panel fuses may require replacement. All fuses can be accessed from the rear panel. See the “FUSES” section for details.

CLEANING

If desired, the interior of the instrument may be cleaned using compressed air to dislodge any accumulated dust. (See the “TOP COVER REMOVAL” section for instructions on accessing the interior.) No other cleaning is recommended.

TRIGGER DAMAGE

The rear-panel TRIG input, used in the external trigger mode, is protected by a diode clamping circuit. However, the protection circuit is not foolproof, and it is possible for a grossly excessive signal to damage the trigger circuitry on the main timing control board (the 4×10 inch board on the right side of the instrument).

The IC that is most likely to fail under these conditions is installed in a socket. It is a standard TTL IC in a 16-pin plastic DIP package, model 74F151 or equivalent.

If you suspect that this IC has been damaged, turn off the power and replace this IC. It may be replaced by a 74F151, 74LS151, 74ALS151, or 74HCT151.

PROGRAMMING YOUR PULSE GENERATOR

KEY PROGRAMMING COMMANDS

The “Programming Manual for -B Instruments” describes in detail how to connect the pulse generator to your computer, and the programming commands themselves. A large number of commands are available; however, normally you will only need a few of these. Here is a basic sample sequence of commands that might be sent to the instrument after power-up:

```
*rst                (resets the instrument)
trigger:source internal (selects internal triggering)
frequency 10 Hz      (sets the frequency to 10 Hz)
pulse:transition 50 ns (sets the rise time to 50 ns)
pulse:width 1 us     (sets the pulse width to 1 us)
pulse:delay 1 us     (sets the delay to 100 ns)
volt1 +1 kV          (sets the HV PULSE amplitude to +1 kV)
volt2 5.0             (sets VCC to +5.0V)
output on            (turns on the output)
```

The output will turn off automatically 90 seconds later, if no further commands are sent before then.

For triggering a single event, this sequence would be more appropriate:

```
*rst                (resets the instrument)
trigger:source hold  (turns off all triggering)
pulse:transition 50 ns (sets the rise time to 1 us)
pulse:width 1 us     (sets the pulse width to 1 us)
volt1 +1 kV          (sets the HV PULSE amplitude to +1 kV)
volt2 5.0             (sets VCC to +5.0V)
output on            (turns on the output)
trigger:source immediate (generates a single non-repetitive trigger event)
trigger:source hold  (turns off all triggering)
output off           (turns off the output)
```

To set the instrument to trigger from an external TTL signal applied to the rear-panel TRIG connector, use:

```
*rst                (resets the instrument)
trigger:source external (selects internal triggering)
pulse:transition 50 ns  (sets the rise time to 50 ns)
pulse:width 1 us       (sets the pulse width to 1 us)
pulse:delay 1 us       (sets the delay to 100 ns)
volt1 +1 kV            (sets the HV PULSE amplitude to +1 kV)
volt2 5.0              (sets VCC to +5.0V)
```

output on (turns on the output)

These commands will satisfy 90% of your programming needs.

ALL PROGRAMMING COMMANDS

For more advanced programmers, a complete list of the available commands is given below. These commands are described in detail in the “Programming Manual for -B Instruments”. (Note: this manual also includes some commands that are not implemented in this instrument. They can be ignored.)

<u>Keyword</u>	<u>Parameter</u>	<u>Notes</u>
OUTPut:		
:STATe	<boolean value>	
:PROTection		
:TRIPped?		[query only]
[SOURce]:		
:FREQuency		
[:CW FIXed]	<numeric value>	
[SOURce]:		
:PULSe		
:PERiod	<numeric value>	
:WIDTh	<numeric value>	
:DCYClE	<numeric value>	
:HOLD	WIDTh DCYClE	
:DELay	<numeric value>	
:GATE		
:TYPE	ASYNc SYNc	
:LEVel	HIgh LOw	
:TRANSition		
:[LEADing]	<numeric value>	
:VOLTagE		
:[LEVel]		
:[IMMediate]		
:[AMPLitude]	<numeric value> EXTeRnal	
STATUS:		
:OPERation		
:[EVENT]?		[query only, always returns "0"]
:CONDition?		[query only, always returns "0"]
:ENABle	<numeric value>	[implemented but not useful]
:QUEStionable		
:[EVENT]?		[query only, always returns "0"]
:CONDition?		[query only, always returns "0"]
:ENABle	<numeric value>	[implemented but not useful]
SYSTem:		
:COMMunicate		
:GPIB		
:ADDReSS	<numeric value>	
:SERial		
:CONTRol		
:RTS	ON IBFull RFR	
:[RECeive]		
:BAUD	1200 2400 4800 9600 19200 38400 57600 115200	
:ERRor		
:[NEXT]?		[query only]
:COUNT?		[query only]
:VERsion?		[query only]
TRIGger:		
:SOURce	INTeRnal EXTeRnal MANual HOLD IMMEDIATE	

*CLS		[no query form]
*ESE	<numeric value>	
*ESR?		[query only]
*IDN?		[query only]
*OPC		
*SAV	0 1 2 3	[no query form]
*RCL	0 1 2 3	[no query form]
*RST		[no query form]
*SRE	<numeric value>	
*STB?		[query only]
*TST?		[query only]
*WAI		[no query form]

WIRING OF AC POWER

WIRING DIAGRAMS

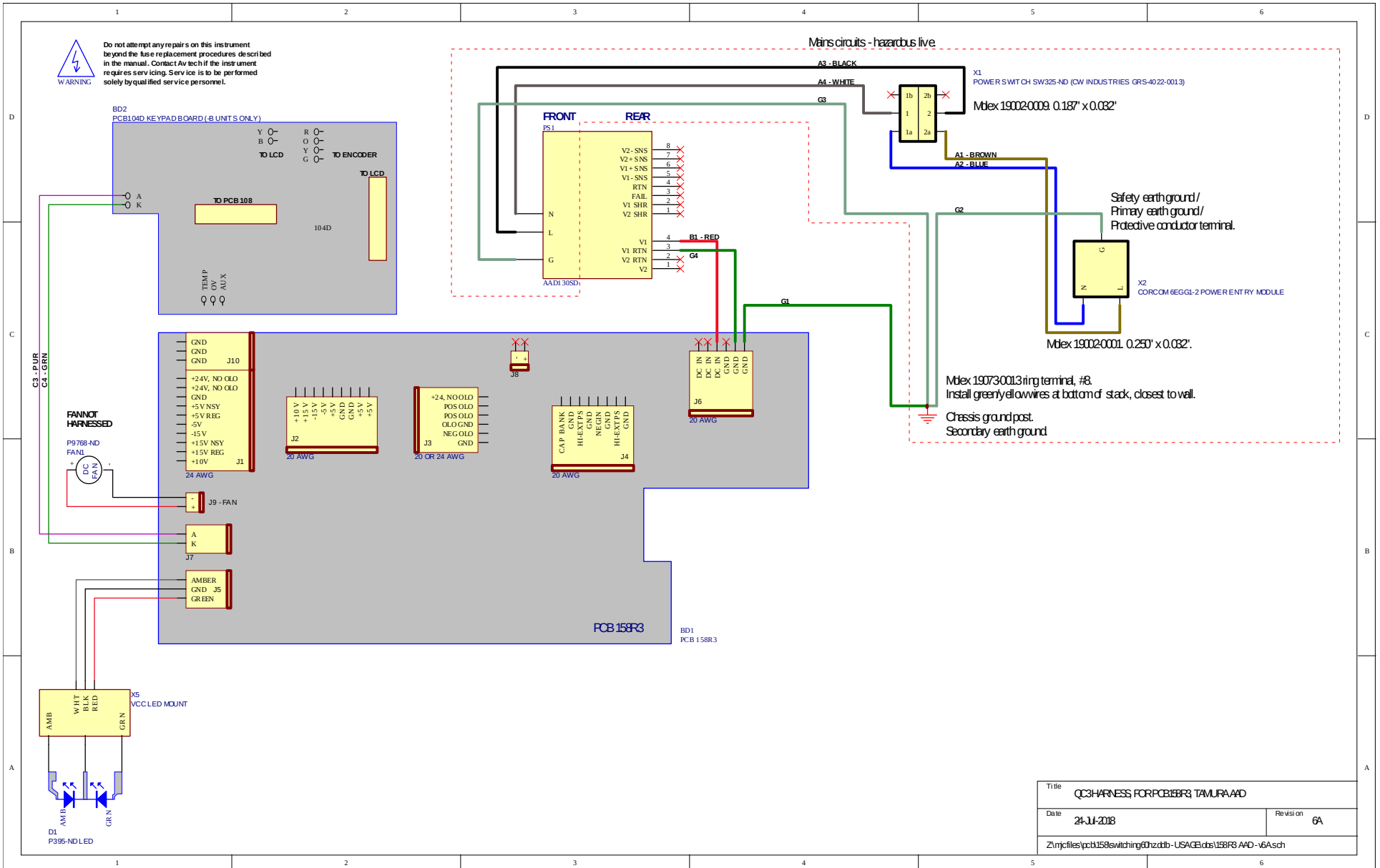

WIRING OF DC POWER FOR -SCHB OPTION

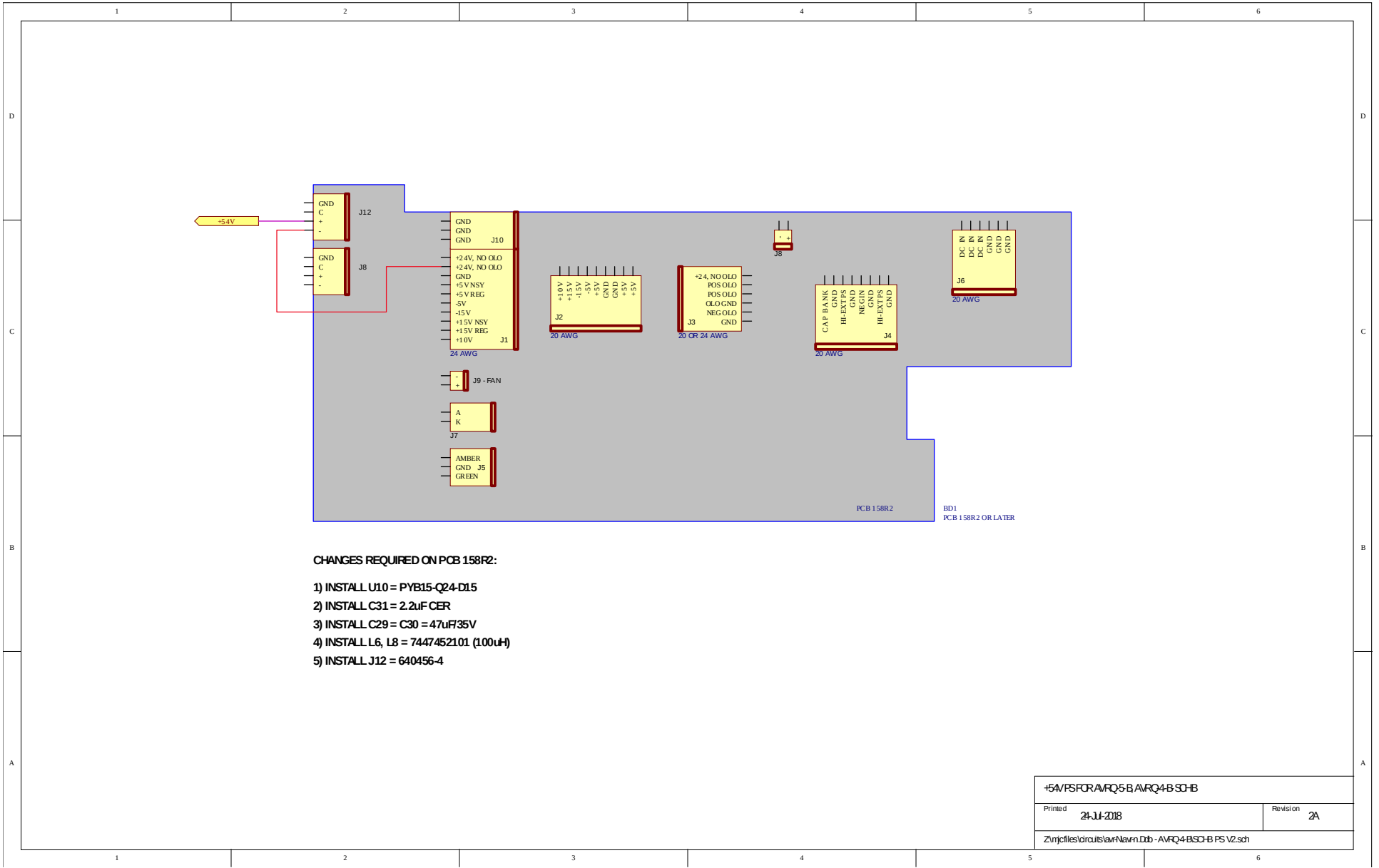

+54V PS FOR AVRQ5B AVRQ4B SCHB		
Printed	24-JUL-2018	Revision 2A
Z:\nrc\files\circuits\avr\Naurn.Ddb - AVRQ4-BSCHB PS V2.sch		

PCB 158R3 - LOW VOLTAGE POWER SUPPLY

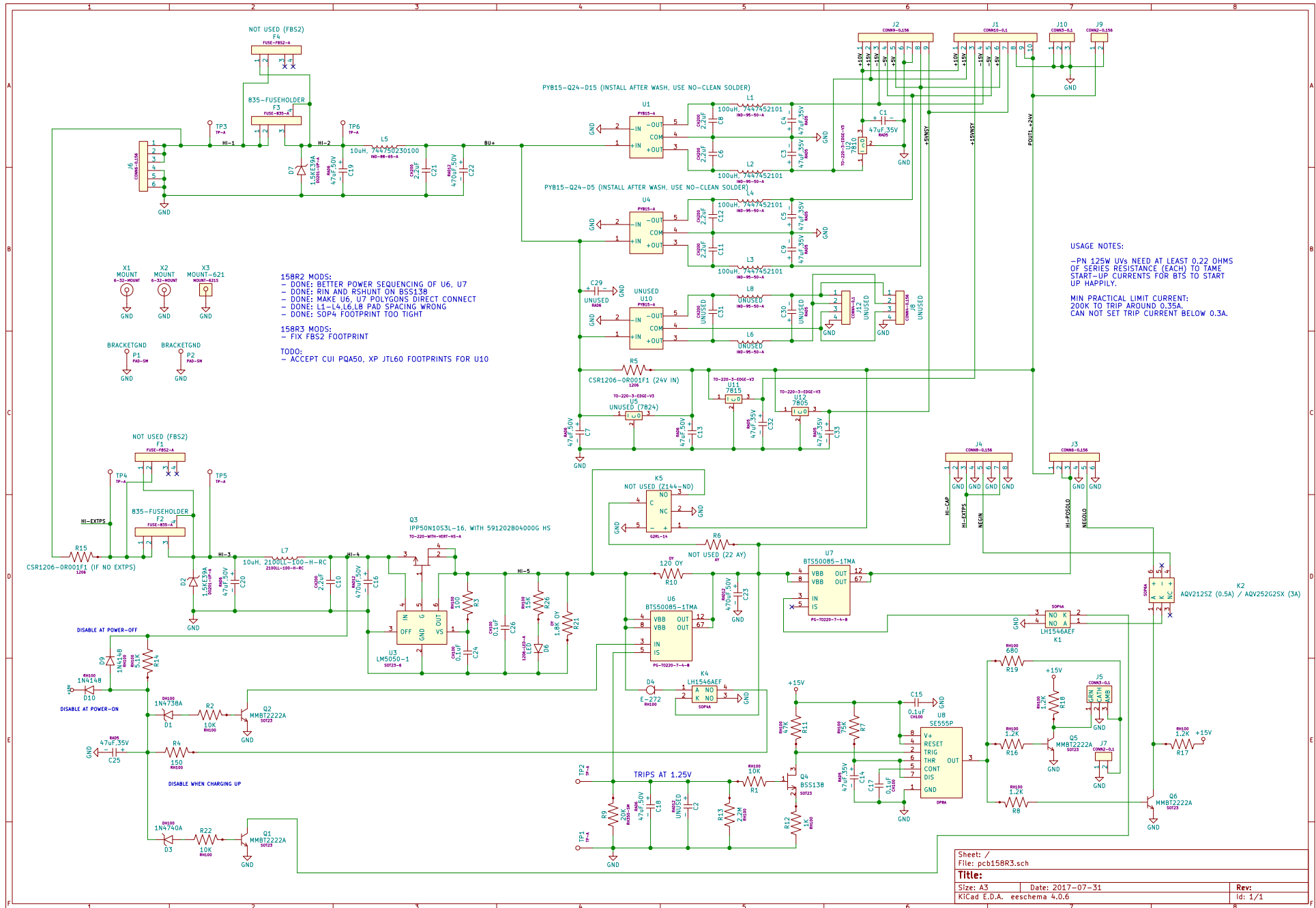

PCB 104F - KEYPAD / DISPLAY BOARD, 1/3

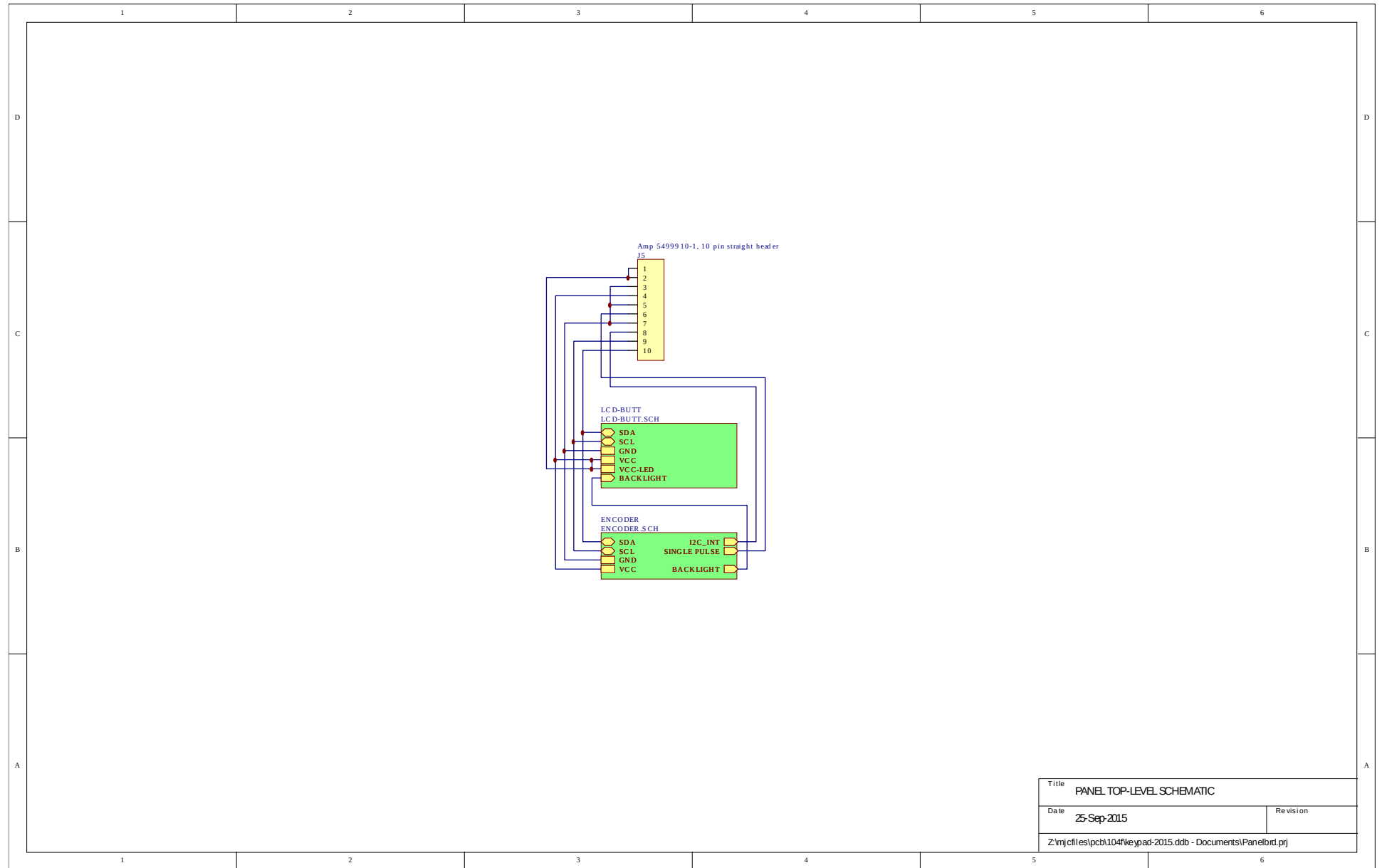

Title		PANEL TOP-LEVEL SCHEMATIC	
Date	25-Sep-2015	Revision	
Z:\njcf\es\pcb\104f\keypad-2015.ddb - Documents\Panelrd.prj			

PCB 104F - KEYPAD / DISPLAY BOARD, 2/3

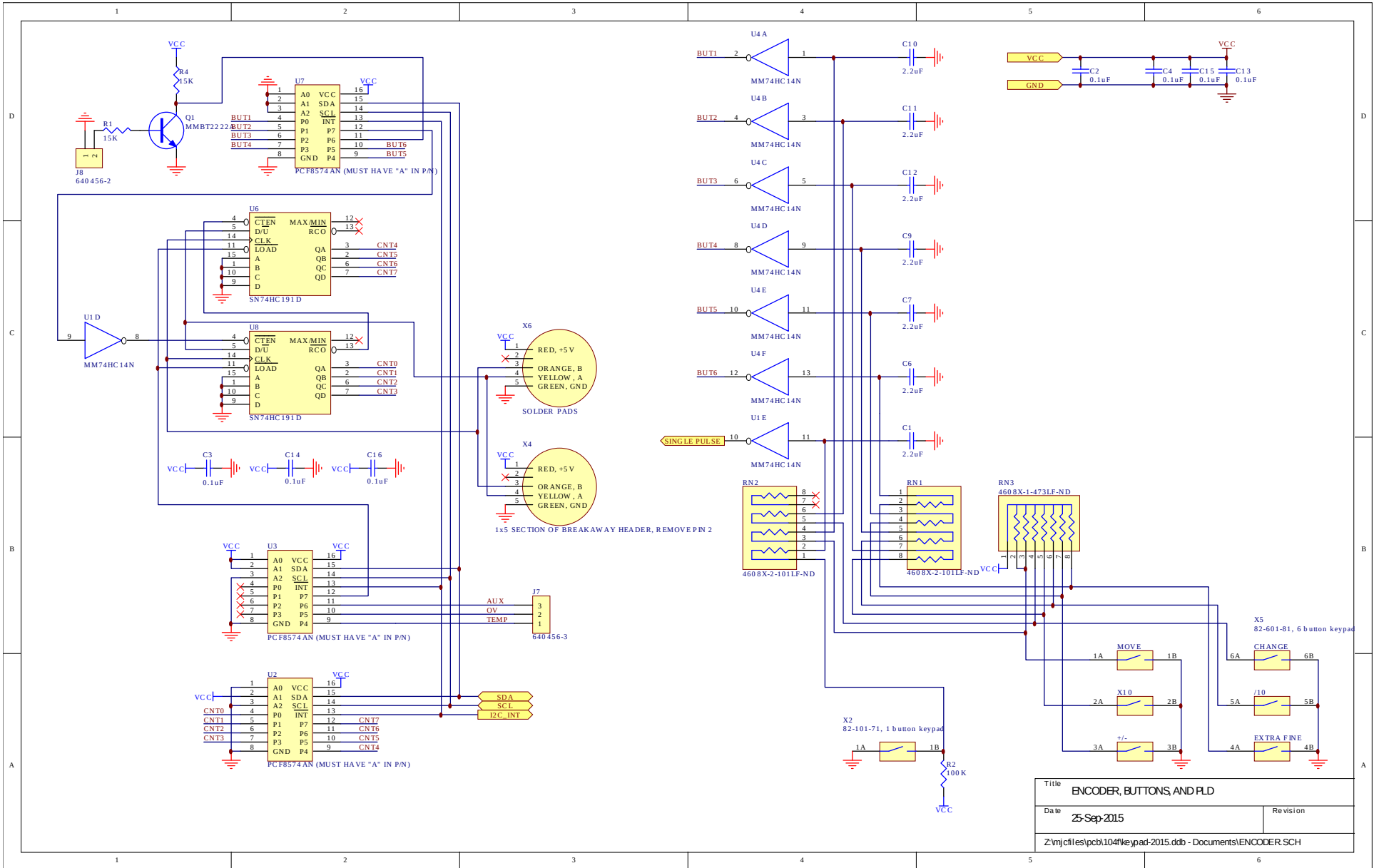

Title		ENCODER, BUTTONS, AND PLD	
Date	25-Sep-2015	Revision	
Z:\njc\files\pcb\104f\keypad-2015.ddb - Documents\ENCODER.SCH			

PCB 104F - KEYPAD / DISPLAY BOARD, 3/3



Title		LCD CIRCUITS, MECHANICAL
Date	25-Sep-2015	Revision
Z:\njcf\es\pcb\104f\keypad-2015.ddb - Documents\LCD-BUT T.SCH		

FLOATING +5V AND DUT WIRING, ON MAIN PCB

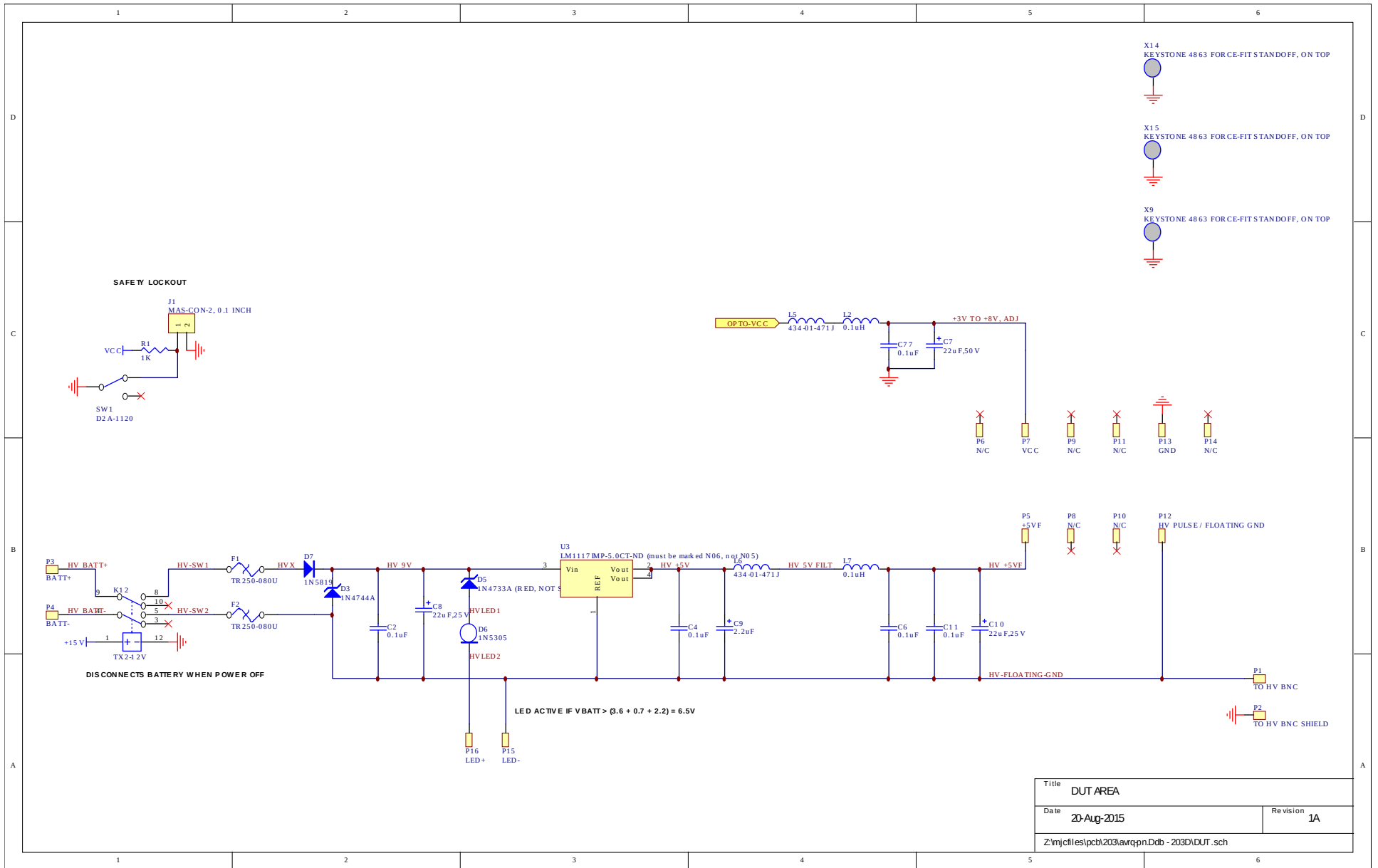

Title		DUT AREA
Date	20-Aug-2015	Revision 1A
Z:\njc\files\pcb\203avr\qpn\203D\DUT.sch		

DUT WIRING, ON STANDARD DAUGHTERBOARD (PCB 213B, 213B7)

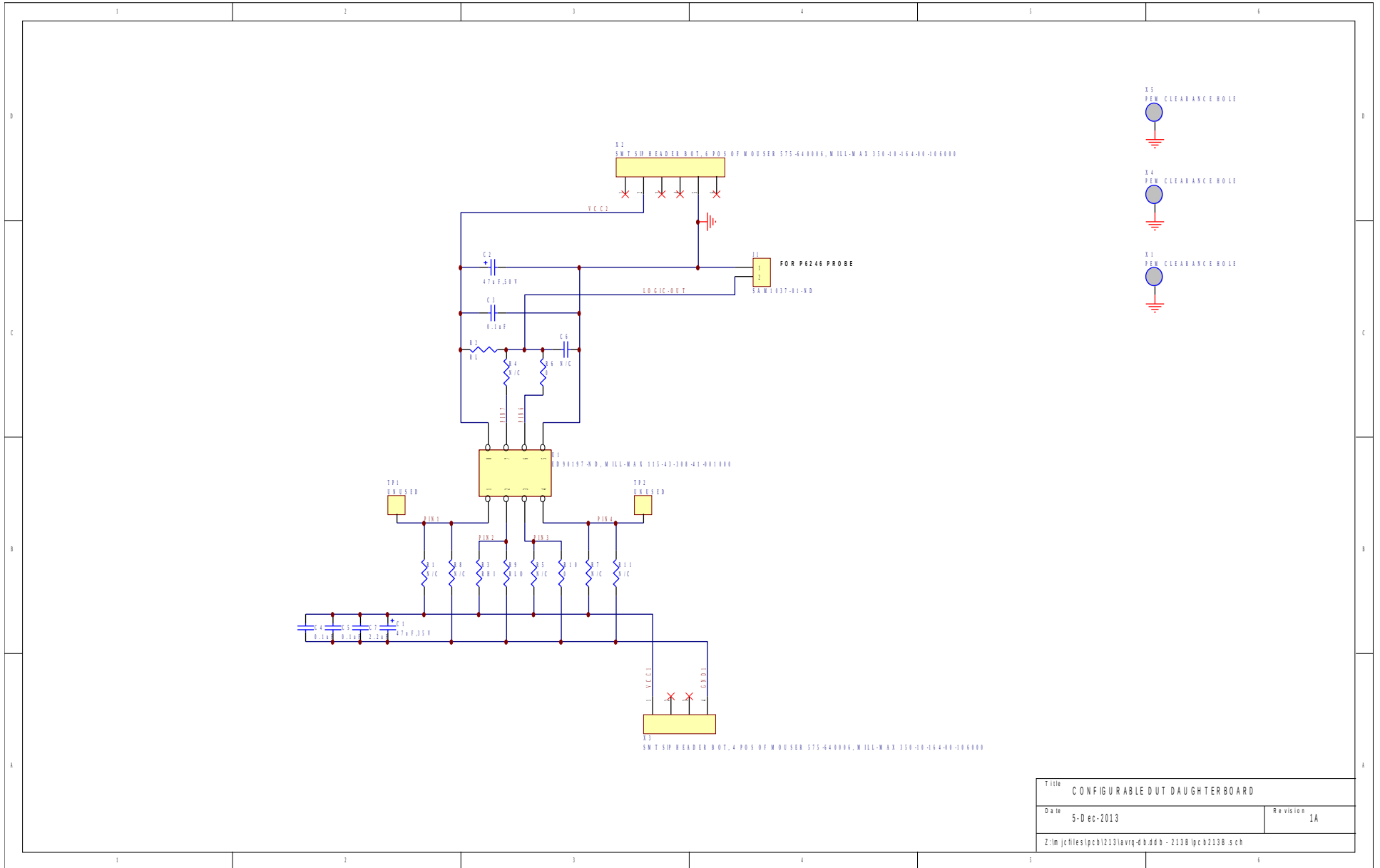

Title		CONFIGURABLE DUT DAUGHTERBOARD
Date	5-Dec-2013	Revision 1A
Z:\m\jcf\files\lpc01213\avrq-d0.d00 - 213B\lpc0213B.sch		

DUT WIRING, ON SO-8 DAUGHTERBOARD (PCB 263A)

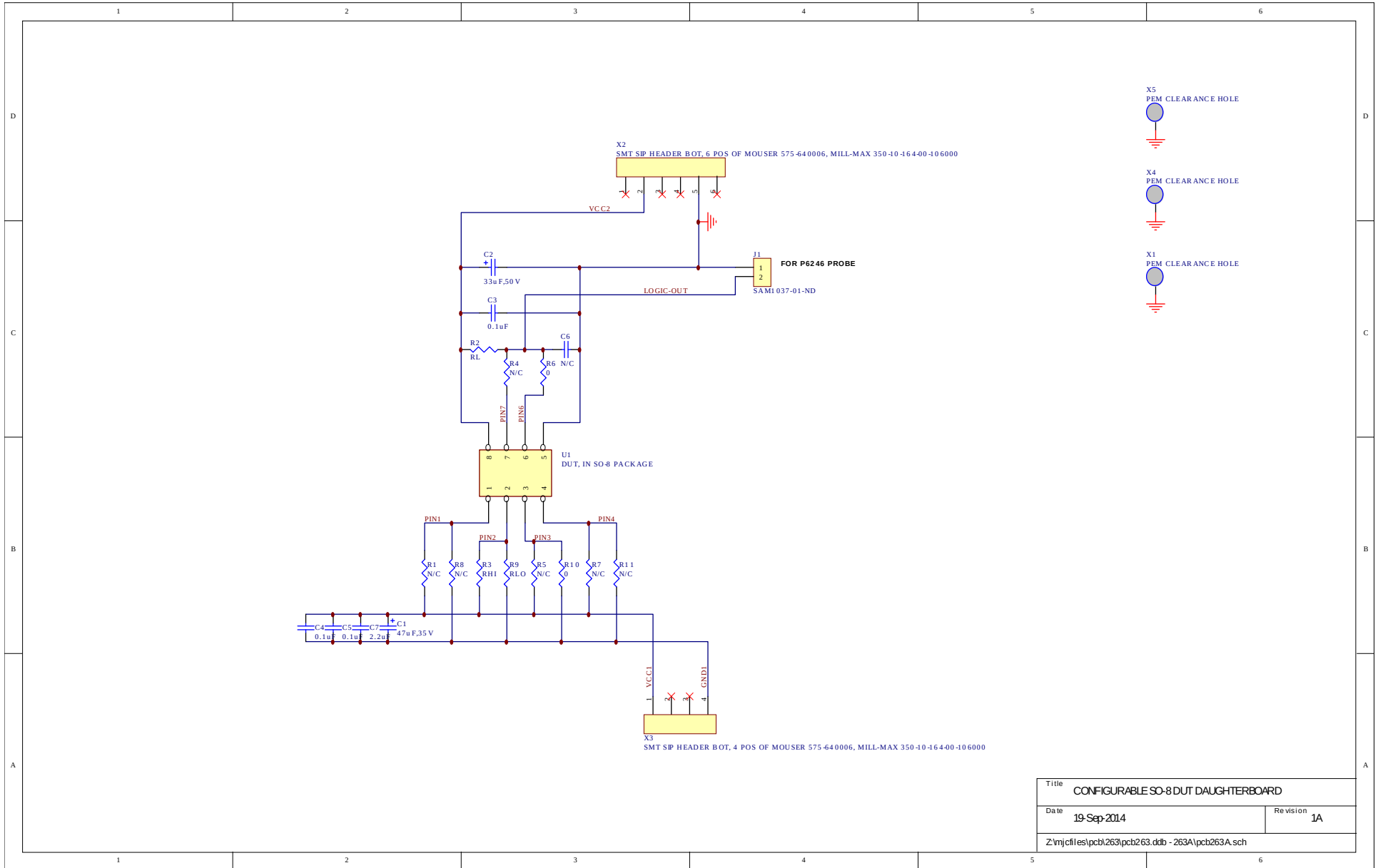

MAIN WIRING

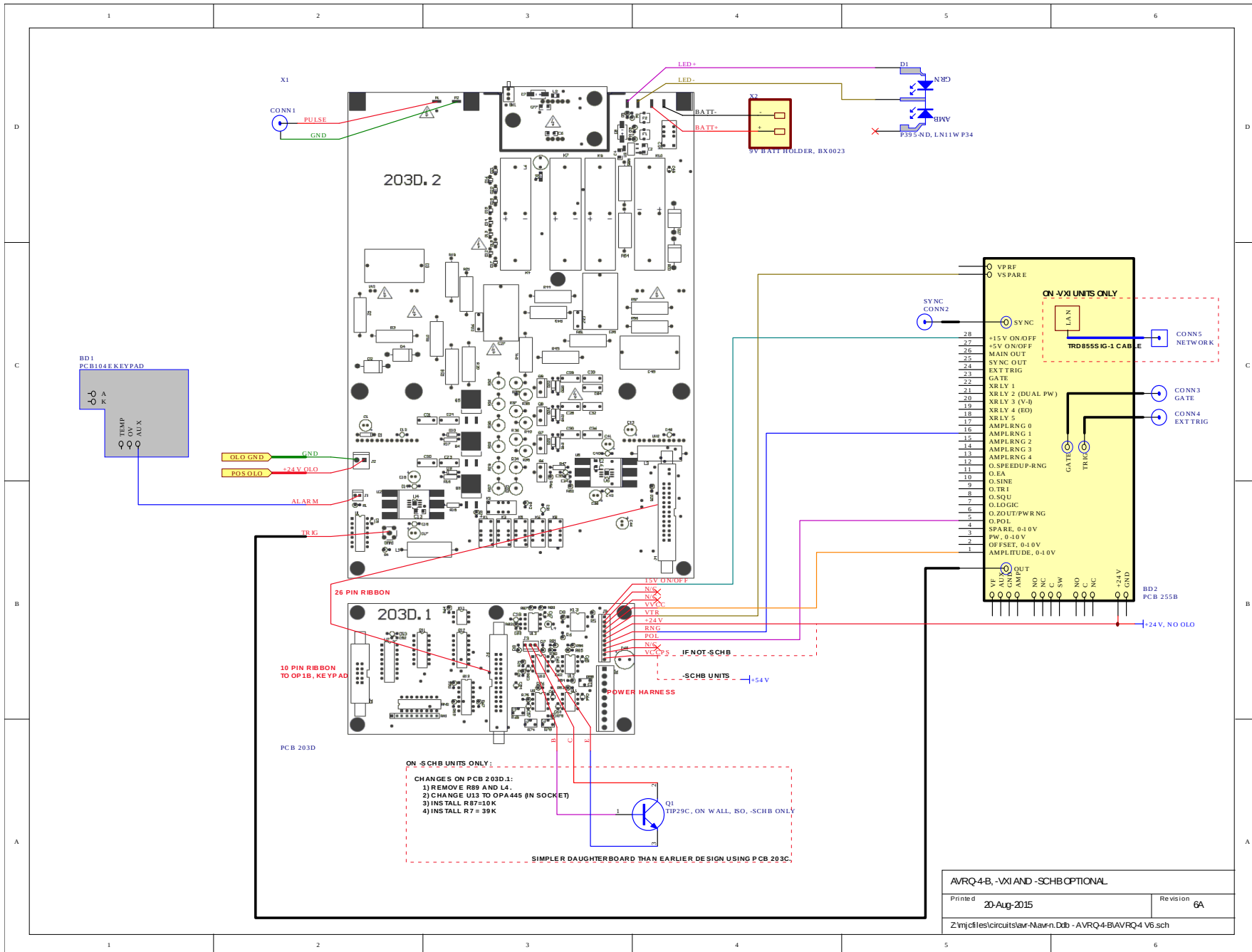

AVRQ-4B, -VXI AND -SCHB OPTIONAL	
Printed 20-Aug-2015	Revision 6A
Z:\mjcl\es\circuits\avr-Nav+n.Ddb - AVRQ-4B\AVRQ-4 V6.sch	

PERFORMANCE CHECK SHEET