



AVTECH ELECTROSYSTEMS LTD.

NANOSECOND WAVEFORM ELECTRONICS
SINCE 1975

P.O. BOX 265
OGDENSBURG, NY
U.S.A. 13669-0265

TEL: 888-670-8729 (USA & Canada) or +1-613-686-6675 (Intl)
FAX: 800-561-1970 (USA & Canada) or +1-613-686-6679 (Intl)

info@avtechpulse.com - <http://www.avtechpulse.com/>

BOX 5120, LCD MERIVALE
OTTAWA, ONTARIO
CANADA K2C 3H5

INSTRUCTIONS

MODEL AVX-FD1-PS

≤ 250 MHz IN, ≤ 5 MHz OUT

FREQUENCY DIVIDER WITH

ADJUSTABLE DIVISION FACTOR

SERIAL NUMBER: _____

WARRANTY

Avtech Electrosystems Ltd. warrants products of its manufacture to be free from defects in material and workmanship under conditions of normal use. If, within one year after delivery to the original owner, and after prepaid return by the original owner, this Avtech product is found to be defective, Avtech shall at its option repair or replace said defective item. This warranty does not apply to units which have been disassembled, modified or subjected to conditions exceeding the applicable specifications or ratings. This warranty is the extent of the obligation assumed by Avtech with respect to this product and no other warranty or guarantee is either expressed or implied.

TECHNICAL SUPPORT

Phone: 888-670-8729 (USA & Canada) or +1-613-686-6675 (International)
Fax: 800-561-1970 (USA & Canada) or +1-613-686-6679 (International)

E-mail: info@avtechpulse.com
World Wide Web: <http://www.avtechpulse.com>

TABLE OF CONTENTS

WARRANTY	2
TECHNICAL SUPPORT	2
TABLE OF CONTENTS	3
INTRODUCTION	5
OPTIONAL FEATURES.....	5
SPECIFICATIONS	6
REGULATORY NOTES	7
FCC PART 18.....	7
EC DECLARATION OF CONFORMITY.....	7
DIRECTIVE 2011/65/EU (RoHS).....	8
DIRECTIVE 2002/96/EC (WEEE).....	8
INSTALLATION	10
VISUAL CHECK.....	10
POWER RATINGS.....	10
CONNECTION TO THE POWER SUPPLY.....	10
PROTECTION FROM ELECTRIC SHOCK.....	11
ENVIRONMENTAL CONDITIONS.....	12
FUSES	13
AC FUSE REPLACEMENT.....	13
DC FUSE REPLACEMENT.....	14
FUSE RATINGS.....	14
FRONT PANEL CONTROLS	15
REAR PANEL CONTROLS	17
GENERAL INFORMATION	18
BASIC TIMING CONTROL.....	18
RESET FUNCTION.....	18
DIVISOR VALUES.....	19
-IP OPTION.....	19
MECHANICAL INFORMATION	20
TOP COVER REMOVAL.....	20
ELECTROMAGNETIC INTERFERENCE.....	20
MAINTENANCE	21
REGULAR MAINTENANCE.....	21
CLEANING.....	21

WIRING DIAGRAMS.....22

WIRING OF AC POWER.....22

PCB 158R4 - LOW VOLTAGE POWER SUPPLY.....23

MAIN WIRING.....24

PERFORMANCE CHECK SHEET.....25

Manual Reference: /files/server1/officefiles/instructword/avx-fd/AVX-FD1-PS,ed17.odt.
Last modified February 29, 2024.
Copyright © 2024 Avtech Electrosystems Ltd, All Rights Reserved.

INTRODUCTION

The Model AVX-FD1-PS digital frequency divider will divide the pulse repetition frequency of an input pulse train by an adjustable factor (N), which is variable from 1 to 999 (or 65535, with the -XN option). The instrument will operate at input frequencies of up to 250 MHz, and output frequencies of up to 5 MHz.

The standard AVX-FD1-PS is designed to work with TTL logic-level signals. The input impedance may be set at either 50 Ω or 1 k Ω by means of a two-position switch. The output pulse width for Model AVX-FD1-PS is controlled by a 3-position range switch and a one-turn fine control, and is variable from 50 ns to 50 μ s.

A TTL "RESET" input and an OPERATE/RESET switch are also provided. A logic-high level on the TTL input resets the internal counters to a default state. This input is useful for synchronization purposes. The OPERATE/RESET switch performs a similar function when it is set to the RESET position.

OPTIONAL FEATURES

The following options are available for the AVX-FD1-PS:

- EP option: Provides complementary output pulses.
- IP option: Accepts pulse or sine wave input from 0.2 to 5.0 Volts peak to peak.
- XN option: Extends the maximum divisor from 999 to 65535.

SPECIFICATIONS

Model:	AVX-FD1-PS
Maximum input frequency:	250 MHz
Maximum output frequency:	5 MHz
Division factor (N):	0 to 999 (optional ¹ : 0 to 65535)
Input level:	TTL (0 and 3-5V)
Input termination:	50 Ω or 1 k Ω to ground, switchable
Input pulse width:	≥ 2 ns
Output level:	TTL (0 and 3-5V)
Outputs:	Main Output: $f_{OUT} = f_{IN}/N$
Output pulse width:	50 ns to 50 μ s
Maximum output duty cycle:	50%
Jitter:	≤ 100 ps
Connectors:	BNC
Prime power:	100 - 240 Volts, 50 - 60 Hz
Dimensions (H x W x D):	100 mm x 215 mm x 375 mm (3.9" x 8.5" x 14.8")
Temperature range:	+5°C to +40°C

1) Add the suffix -XN to the model number for an extended division factor range of 0 to 65535.

REGULATORY NOTES

FCC PART 18

This device complies with part 18 of the FCC rules for non-consumer industrial, scientific and medical (ISM) equipment.

This instrument is enclosed in a rugged metal chassis and uses a filtered power entry module (where applicable). The main output signal is provided on a shielded connector that is intended to be used with shielded coaxial cabling and a shielded load. Under these conditions, the interference potential of this instrument is low.

If interference is observed, check that appropriate well-shielded cabling is used on the output connectors. Contact Avtech (info@avtechpulse.com) for advice if you are unsure of the most appropriate cabling. Also, check that your load is adequately shielded. It may be necessary to enclose the load in a metal enclosure.

If any of the connectors on the instrument are unused, they should be covered with shielded metal "dust caps" to reduce the interference potential.

This instrument does not normally require regular maintenance to minimize interference potential. However, if loose hardware or connectors are noted, they should be tightened. Contact Avtech (info@avtechpulse.com) if you require assistance.

EC DECLARATION OF CONFORMITY



We Avtech Electrosystems Ltd.
 P.O. Box 5120, LCD Merivale
 Ottawa, Ontario
 Canada K2C 3H5

declare that this pulse generator meets the intent of Directive 2004/108/EG for Electromagnetic Compatibility. Compliance pertains to the following specifications as listed in the official Journal of the European Communities:

EN 50081-1 Emission

EN 50082-1 Immunity

and that this pulse generator meets the intent of the Low Voltage Directive 2006/95/EC. Compliance pertains to the following specifications as listed in the official Journal of the European Communities:

EN 61010-1:2001 Safety requirements for electrical equipment for measurement, control, and laboratory use

DIRECTIVE 2011/65/EU (RoHS)

We Avtech Electrosystems Ltd.
P.O. Box 5120, LCD Merivale
Ottawa, Ontario
Canada K2C 3H5

declare that, to the best of our knowledge, all electrical and electronic equipment (EEE) sold by the company are in compliance with Directive 2011/65/EU of the European Parliament and of the Council of 8 June 2011 on the restriction of the use of certain hazardous substances in electrical and electronic equipment (also known as “RoHS Recast”). In addition, this declaration of conformity is issued under the sole responsibility of Avtech Electrosystems Ltd. Specifically, products manufactured do not contain the substances listed in the table below in concentrations greater than the listed maximum value.

<i>Material/Substance</i>	<i>Threshold level</i>
Lead (Pb)	< 1000 ppm (0.1% by mass)
Mercury (Hg)	< 1000 ppm (0.1% by mass)
Hexavalent Chromium (Cr6+)	< 1000 ppm (0.1% by mass)
Polybrominated Biphenyls (PBB)	< 1000 ppm (0.1% by mass)
Polybrominated Diphenyl ethers (PBDE)	< 1000 ppm (0.1% by mass)
Cadmium (Cd)	< 100 ppm (0.01% by mass)

DIRECTIVE 2002/96/EC (WEEE)

European customers who have purchased this equipment directly from Avtech will have completed a “WEEE Responsibility Agreement” form, accepting responsibility for WEEE compliance (as mandated in Directive 2002/96/EC of the European Union and local laws) on behalf of the customer, as provided for under Article 9 of Directive 2002/96/EC.

Customers who have purchased Avtech equipment through local representatives should consult with the representative to determine who has responsibility for WEEE compliance. Normally, such responsibilities will lie with the representative, unless other arrangements (under Article 9) have been made.

Requirements for WEEE compliance may include registration of products with local governments, reporting of recycling activities to local governments, and financing of recycling activities.

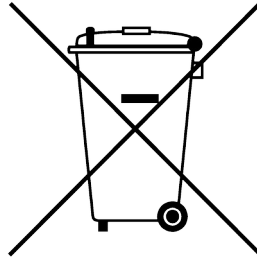

INSTALLATION

VISUAL CHECK

After unpacking the instrument mainframe and the transformer module, examine to ensure that they have not been damaged in shipment. Visually inspect all connectors, knobs, and handles. Confirm that a power cord and an instrumentation manual (this manual), are with the instrument. If the instrument has been damaged, file a claim immediately with the company that transported the instrument.

POWER RATINGS

This instrument is intended to operate from 100 - 240 V, 50 - 60 Hz.

The maximum power consumption is 57 Watts. Please see the “FUSES” section for information about the appropriate AC and DC fuses.

This instrument is an “Installation Category II” instrument, intended for operation from a normal single-phase supply.

CONNECTION TO THE POWER SUPPLY

An IEC-320 three-pronged recessed male socket is provided on the back panel for AC power connection to the instrument. One end of the detachable power cord that is supplied with the instrument plugs into this socket. The other end of the detachable power cord plugs into the local mains supply. Use only the cable supplied with the instrument. The mains supply must be earthed, and the cord used to connect the instrument to the mains supply must provide an earth connection. (The supplied cord does this.)

 Warning: Failure to use a grounded outlet may result in injury or death due to electric shock. This product uses a power cord with a ground connection. It must be connected to a properly grounded outlet. The instrument chassis is connected to the ground wire in the power cord.

The table below describes the power cord that is normally supplied with this instrument, depending on the destination region:

Destination Region	Description	Option	Manufacturer	Part Number
United Kingdom, Hong Kong, Singapore, Malaysia	BS 1363, 230V, 50 Hz	-AC00	Qualtek	370001-E01
Australia, New Zealand	AS 3112:2000, 230-240V, 50 Hz	-AC01	Qualtek	374003-A01
Continental Europe, Korea, Indonesia, Russia	European CEE 7/7 "Schuko" 230V, 50 Hz	-AC02	Qualtek	364002-D01
North America, Taiwan	NEMA 5-15, 120V, 60 Hz	-AC03	Qualtek	312007-01
Switzerland	SEV 1011, 230V, 50 Hz	-AC06	Qualtek	378001-E01
South Africa, India	SABS 164-1, 220-250V, 50 Hz	-AC17	Volex	2131H 10 C3
Japan	JIS 8303, 100V, 50-60 Hz	-AC18	Qualtek	397002-01
Israel	SI 32, 220V, 50 Hz	-AC19	Qualtek	398001-01
China	GB 1002-1 / 2099-1, 220V, 50 Hz	-AC22	Qualtek	399012-01

PROTECTION FROM ELECTRIC SHOCK

 Operators of this instrument must be protected from electric shock at all times. The owner must ensure that operators are prevented access and/or are insulated from every connection point. In some cases, connections must be exposed to potential human contact. Operators must be trained to protect themselves from the risk of electric shock. This instrument is intended for use by qualified personnel who recognize shock hazards and are familiar with safety precautions required to avoid possibly injury. In particular, operators should:

1. Keep exposed high-voltage wiring to an absolute minimum.
2. Wherever possible, use shielded connectors and cabling.
3. Connect and disconnect loads and cables only when the instrument is turned off.
4. Keep in mind that all cables, connectors, oscilloscope probes, and loads must have an appropriate voltage rating.
5. Do not attempt any repairs on the instrument, beyond the fuse replacement procedures described in this manual. Contact Avtech technical support (see page 2 for contact information) if the instrument requires servicing. Service is to be performed solely by qualified service personnel.

ENVIRONMENTAL CONDITIONS

This instrument is intended for use under the following conditions:

1. indoor use;
2. altitude up to 2 000 m;
3. temperature 5 °C to 40 °C;
4. maximum relative humidity 80 % for temperatures up to 31 °C decreasing linearly to 50 % relative humidity at 40 °C;
5. Mains supply voltage fluctuations up to ± 10 % of the nominal voltage;
6. no pollution or only dry, non-conductive pollution.

FUSES

This instrument contains four fuses. All are accessible from the rear-panel. Two protect the AC prime power input, and two protect the internal DC power supplies. The locations of the fuses on the rear panel are shown in the figure below:

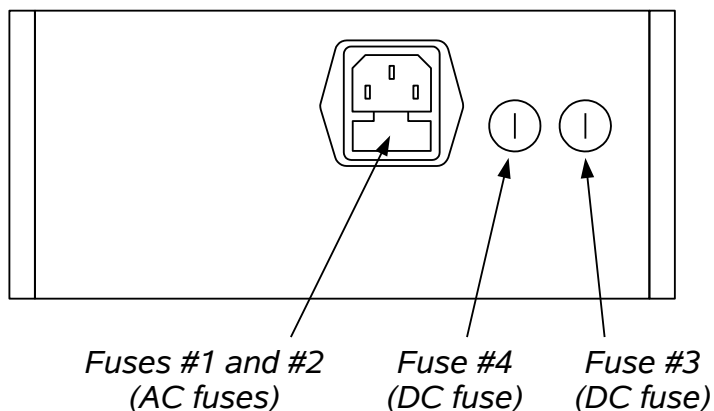

AC FUSE REPLACEMENT

To physically access the AC fuses, the power cord must be detached from the rear panel of the instrument. The fuse drawer may then be extracted using a small flat-head screwdriver, as shown below:

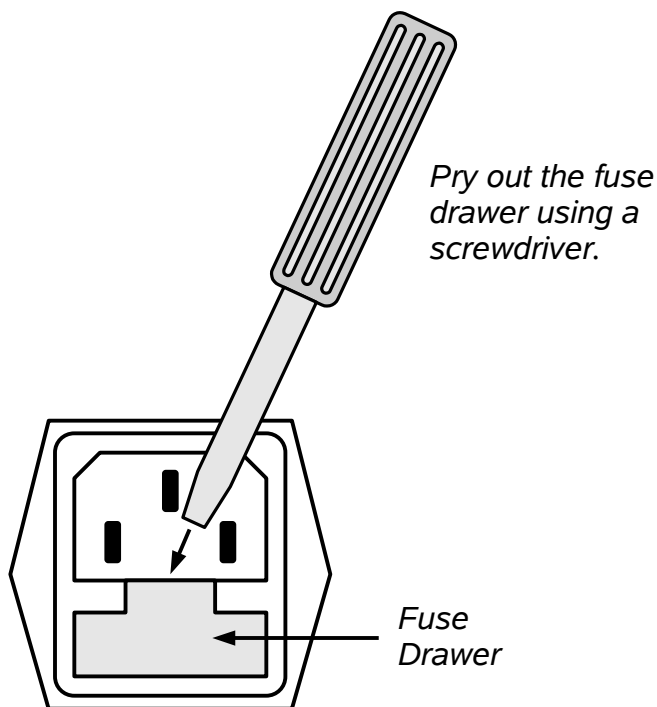

DC FUSE REPLACEMENT

The DC fuses may be replaced by inserting the tip of a flat-head screwdriver into the fuse holder slot, and rotating the slot counter-clockwise. The fuse and its carrier will then pop out.

FUSE RATINGS

The following table lists the required fuses:

Fuses	Nominal Mains Voltage	Rating	Case Size	Recommended Replacement Part	
				Littelfuse Part Number	Digi-Key Stock Number
#1, #2 (AC)	100-240V	0.5A, 250V, Time-Delay	5×20 mm	0218.500HXP	F2416-ND
#3 (DC)	N/A	0.8A, 250V, Time-Delay	5×20 mm	0218.800HXP	F2418-ND
#4 (DC)	N/A	Not used. A spare 0.8A fuse is installed here.			

The recommended fuse manufacturer is Littelfuse (<http://www.littelfuse.com>).

Replacement fuses may be easily obtained from Digi-Key (<http://www.digikey.com>) and other distributors.

FRONT PANEL CONTROLS

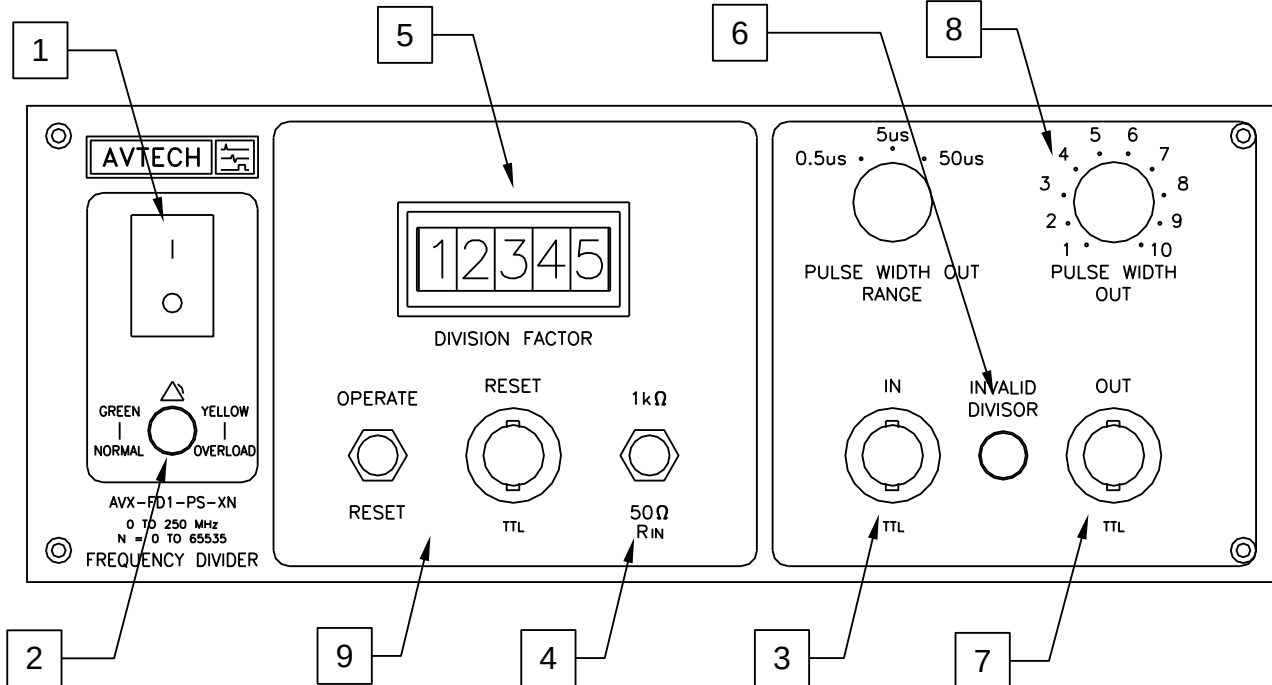

1. POWER Switch. This is the main power switch. When turning the instrument on, there may be a delay of several seconds before the instrument appears to respond.
2. OVERLOAD Indicator. When the instrument is powered, this indicator is normally green, indicating normal operation. If this indicator is yellow, an internal automatic overload protection circuit has been tripped. If the unit is overloaded (by operating at an exceedingly high duty cycle or by operating into a very low impedance), the protective circuit will disable the output of the instrument and turn the indicator light yellow. The light will stay yellow (i.e. output disabled) for about 5 seconds after which the instrument will attempt to re-enable the output (i.e. light green) for about 1 second. If the overload condition persists, the output will be disabled again (i.e. light yellow) for another 5 seconds. If the overload condition has been removed, the instrument will resume normal operation.

This overload indicator may flash yellow briefly at start-up. This is not a cause for concern.

3. IN CONNECTOR. The input signal is applied to this BNC connector.
4. INPUT MODE SWITCH. This switch determines the input levels required at the IN connector.

In the "TTL 1 k Ω " mode, the input requires TTL levels (i.e. logic low = 0V, logic high = 3 to 5V), and the input impedance is 1 k Ω .

In the "TTL 50 Ω " mode, the input requires TTL levels (i.e. logic low = 0V, logic high =

3 to 5V), and the input impedance is 50Ω.

For units with the -IP option: In the “IP 50Ω” mode, the input requires a sine wave input from 0.2 to 5.0 Volts peak to peak, and the input impedance is 50Ω.

5. DIVISION FACTOR THUMBWHEEL SWITCH. This switch determines the division factor, N. The input and output pulse repetition frequencies (f_{in} and f_{out}) are related by: $f_{out} = f_{in} / N$. Standard models will have a 3-digit switch. Models with the -XN option will have 5 digits.
6. INVALID DIVISOR INDICATOR. (Present on units with the -XN option only.) This indicator becomes yellow if the divisor is set outside of the valid range of 0 to 65535.
7. OUT CONNECTOR. The output signal is provided on this connector. Standard models generate TTL-level outputs (i.e. logic low = 0V, logic high = 3 to 5V), which will drive loads as low as 50Ω.
8. PULSE WIDTH RANGE and FINE CONTROLS. This range switch and fine control are used to set the output pulse width.
9. RESET CONNECTOR. A TTL-level pulse on the RESET connector will reset the internal counters to a default state. This can be used for synchronisation purposes. The connector may be left unconnected without interfering with normal operation.

The OPERATE/RESET switch can be used to achieve this function manually. That is, setting this switch to the “RESET” position will reset the internal counters to a default state.

REAR PANEL CONTROLS

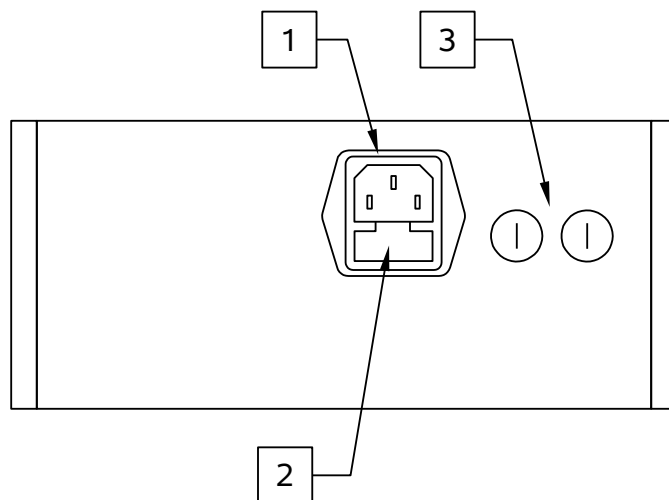

1. AC POWER INPUT. An IEC-320 C14 three-pronged recessed male socket is provided on the back panel for AC power connection to the instrument. One end of the detachable power cord that is supplied with the instrument plugs into this socket.
2. AC FUSE DRAWER. The two fuses that protect the AC input are located in this drawer. Please see the “FUSES” section of this manual for more information.
3. DC FUSES. These two fuses protect the internal DC power supplies. Please see the “FUSES” sections of this manual for more information.

GENERAL INFORMATION

BASIC TIMING CONTROL

This instrument operates by counting the number of input pulses, and generating an output pulse for every N input pulses. N is set by the thumbwheel switches on the front panel.

This function is illustrated below, assuming that $N=4$.

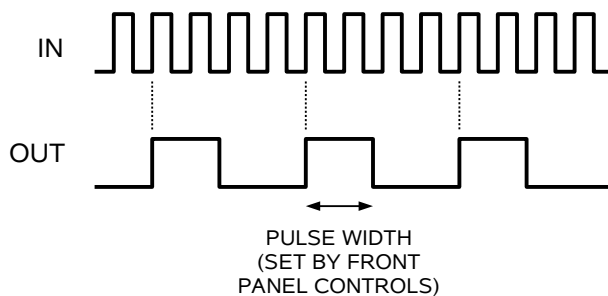

Basic Operation

Note that if the input signal is non-periodic, the output signal will also be non-periodic:

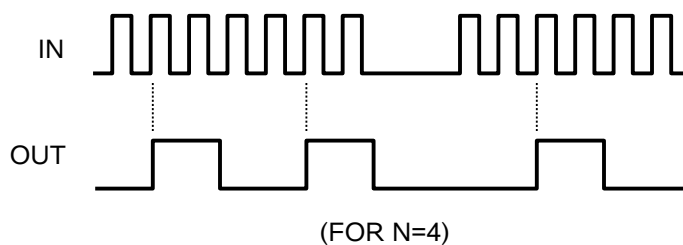

Basic Operation for Non-Periodic Inputs

RESET FUNCTION

A reset input and switch are provided on the front panel, which can be used for synchronization, as shown below:

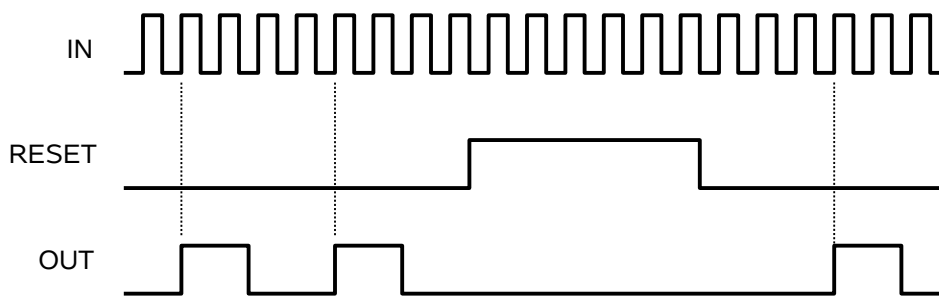

In this example, $N=4$. When the reset input is TTL high, the internal counter are reset to zero and are held at zero until the reset input switches to TTL low. An output pulse is generated on the fourth input pulse after the reset line returns to TTL low.

DIVISOR VALUES

The frequency divisor may be set at any value between 1 and 999, inclusive, for normal operation. The divisor may also be set to zero, in which case a constant logic-low output is generated.

The divisor may be set for $N=1$. In this mode, the instrument essentially acts as a pulse-stretcher or "one-shot", since the output pulse width is controlled from the front panel.

-IP OPTION

Models with the -IP option will accept logic-level inputs, but will also trigger from a sine wave input (or pulse input with approximately 50% duty cycle) with amplitudes from 0.2 to 5.0 Volts peak to peak. Set the Input Mode Switch to "IP 50 Ω " to enable this mode.

MECHANICAL INFORMATION

TOP COVER REMOVAL

If necessary, the interior of the instrument may be accessed by removing the four Phillips screws on the top panel. With the four screws removed, the top cover may be slid back (and off).

 Always disconnect the power cord and allow the instrument to sit unpowered for 10 minutes before opening the instrument. This will allow any internal stored charge to discharge.

There are no user-adjustable internal circuits. For repairs other than fuse replacement, please contact Avtech (info@avtechpulse.com) to arrange for the instrument to be returned to the factory for repair. Service is to be performed solely by qualified service personnel.

 Caution: High voltages are present inside the instrument during normal operation. Do not operate the instrument with the cover removed.

ELECTROMAGNETIC INTERFERENCE

To prevent electromagnetic interference with other equipment, all used outputs should be connected to shielded loads using shielded coaxial cables. Unused outputs should be terminated with shielded coaxial terminators or with shielded coaxial dust caps, to prevent unintentional electromagnetic radiation. All cords and cables should be less than 3m in length.

MAINTENANCE

REGULAR MAINTENANCE

This instrument does not require any regular maintenance.

On occasion, one or more of the four rear-panel fuses may require replacement. All fuses can be accessed from the rear panel. See the “FUSES” section for details.

CLEANING

If desired, the interior of the instrument may be cleaned using compressed air to dislodge any accumulated dust. (See the “TOP COVER REMOVAL” section for instructions on accessing the interior.) No other cleaning is recommended.

WIRING OF AC POWER

WIRING DIAGRAMS

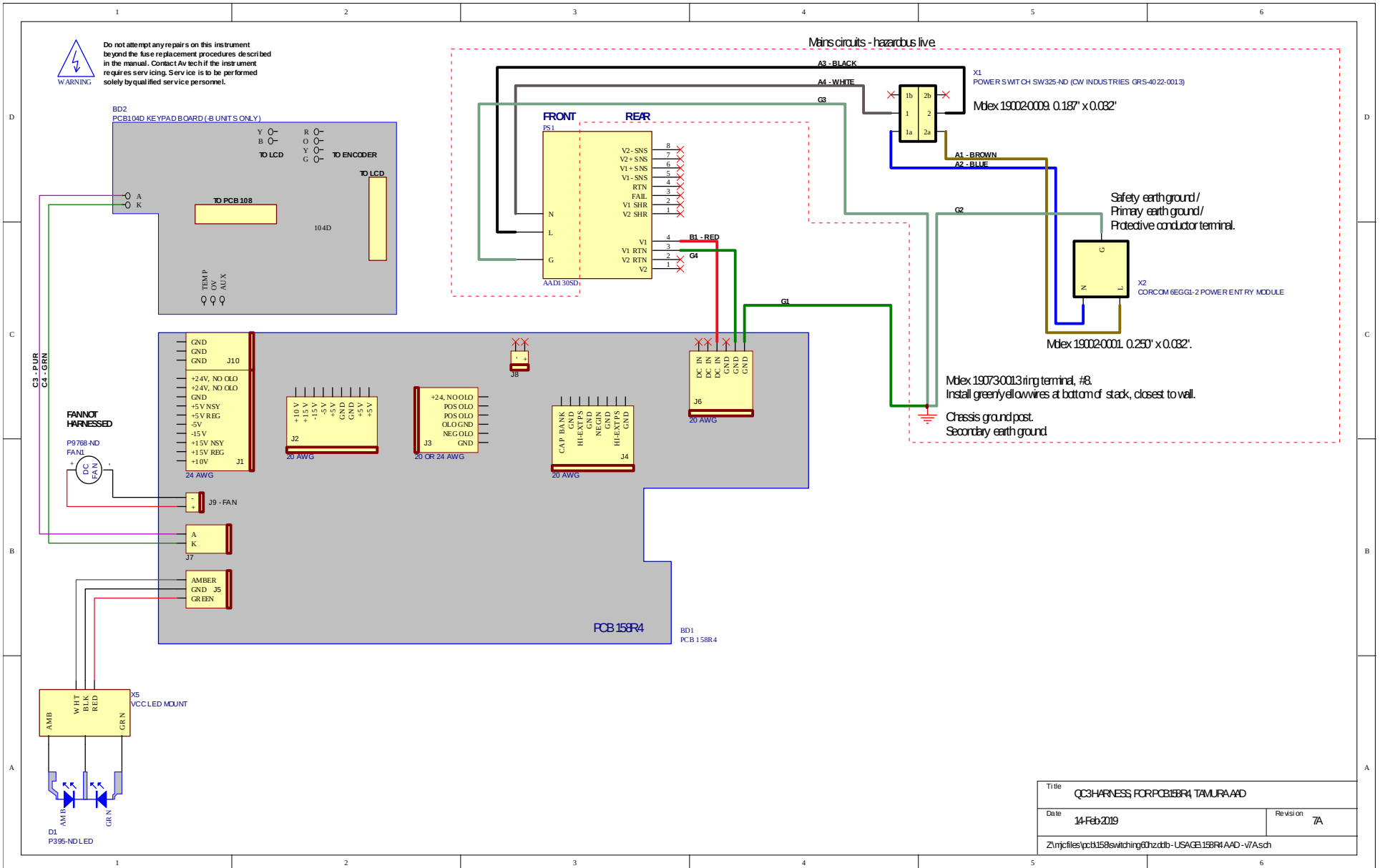

PCB 158R4 - LOW VOLTAGE POWER SUPPLY

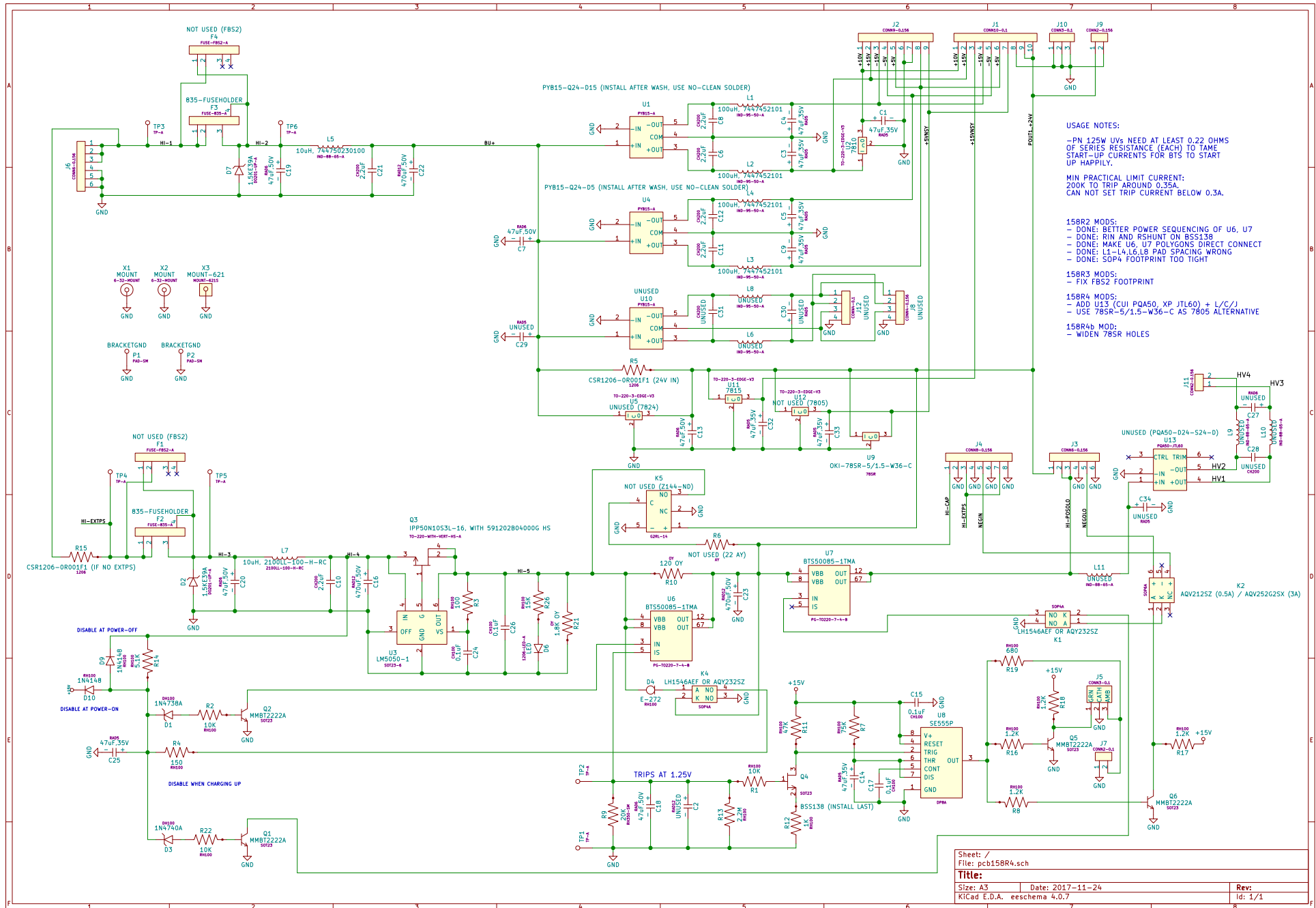

MAIN WIRING

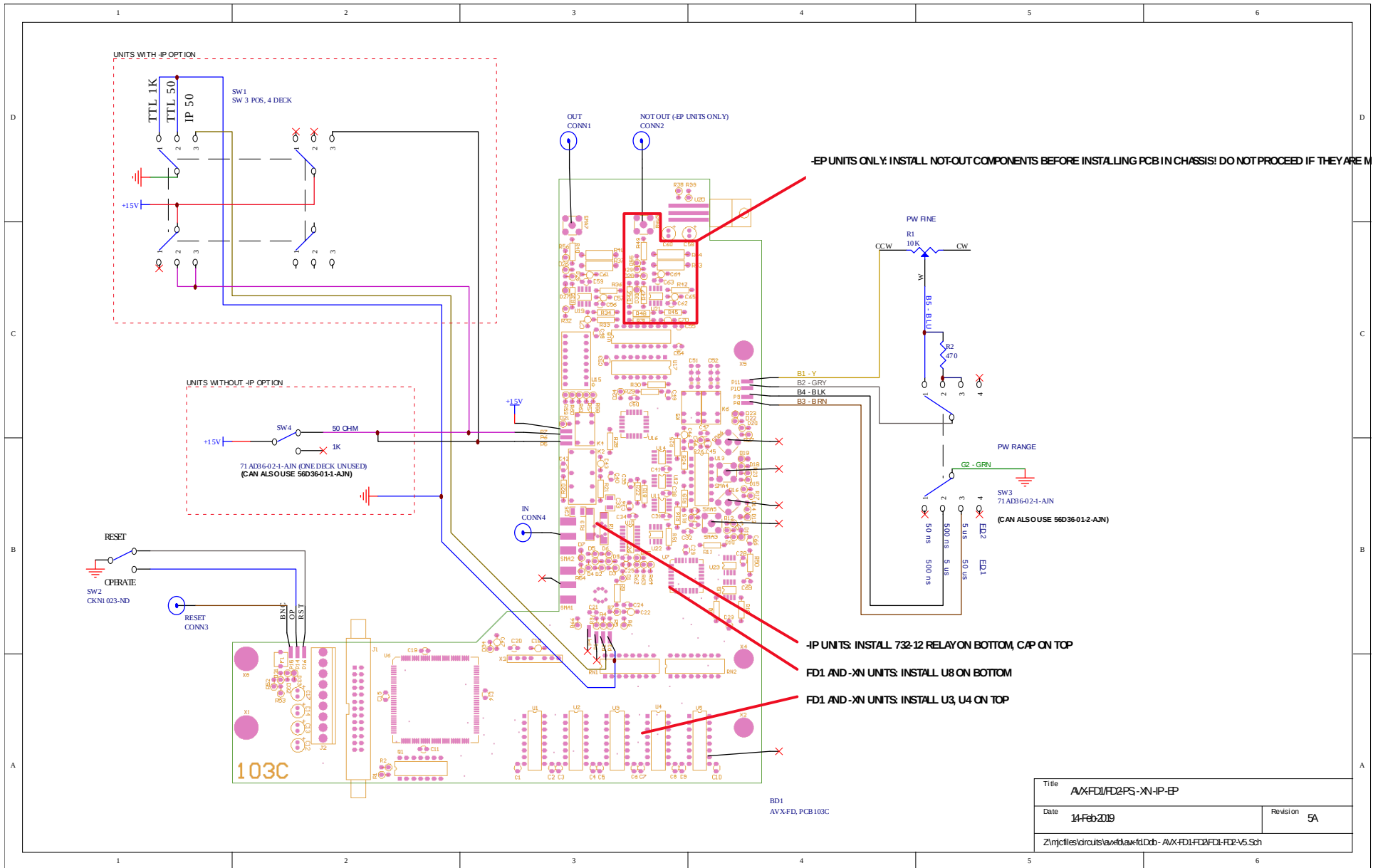

PERFORMANCE CHECK SHEET