



AVTECH ELECTROSYSTEMS LTD.

NANOSECOND WAVEFORM ELECTRONICS
SINCE 1975

□ P.O. BOX 265
OGDENSBURG, NY
U.S.A. 13669-0265

TEL: 888-670-8729 (USA & Canada) or +1-613-686-6675 (Intl)
FAX: 800-561-1970 (USA & Canada) or +1-613-686-6679 (Intl)

info@avtechpulse.com - <http://www.avtechpulse.com/>

☒ BOX 5120, LCD MERIVALE
OTTAWA, ONTARIO
CANADA K2C 3H5

INSTRUCTIONS

MODEL AVX-S1-P2-EX1

PLUG-IN SOCKET OUTPUT MODULE

SERIAL NUMBER: _____

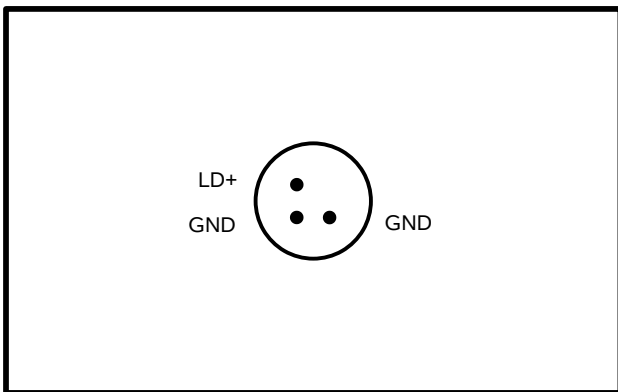

AVX-S1-P2-EX1 OUTPUT MODULE, SOCKET VIEW

**MATCHING USER-SUPPLIED
DIODE PACKAGES
(BOTTOM VIEW),
5.6 mm PACKAGE,
2.0 mm PIN CIRCLE DIAMETER**

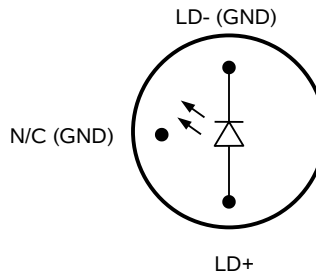

WARRANTY

Avtech Electrosystems Ltd. warrants products of its manufacture to be free from defects in material and workmanship under conditions of normal use. If, within one year after delivery to the original owner, and after prepaid return by the original owner, this Avtech product is found to be defective, Avtech shall at its option repair or replace said defective item. This warranty does not apply to units which have been disassembled, modified or subjected to conditions exceeding the applicable specifications or ratings. This warranty is the extent of the obligation assumed by Avtech with respect to this product and no other warranty or guarantee is either expressed or implied.

TECHNICAL SUPPORT

Phone: 888-670-8729 (USA & Canada) or +1-613-686-6675 (International)

Fax: 800-561-1970 (USA & Canada) or +1-613-686-6679 (International)

E-mail: info@avtechpulse.com

World Wide Web: <http://www.avtechpulse.com>

TABLE OF CONTENTS

WARRANTY.....	2
TECHNICAL SUPPORT.....	2
TABLE OF CONTENTS.....	3
INTRODUCTION.....	4
SPECIFICATIONS.....	5
REGULATORY NOTES.....	6
FCC PART 18.....	6
EC DECLARATION OF CONFORMITY.....	6
DIRECTIVE 2002/95/EC (RoHS).....	7
DIRECTIVE 2002/96/EC (WEEE).....	7
GENERAL INFORMATION.....	8
BASIC TEST ARRANGEMENT.....	8
AMPLITUDE CONTROL.....	9
COMPATIBLE PULSE GENERATORS.....	10

Manual Reference: /fileserver1/officefiles/instructword/avx-s/AVX-S1-P2-EX1,ed1.odt.

Last modified February 29, 2024.

Copyright © 2024 Avtech Electrosystems Ltd, All Rights Reserved.

INTRODUCTION

The AVX-S series of bias insertion units is designed to combine a pulse signal with a DC bias, and supply the resulting signal to a laser diode, which is inserted into a high quality socket included on the mount. The bias insertion module includes the necessary networks to match the laser diode to the pulse source, as well as networks for applying DC bias to the diode.

The AVX-S1-P2-EX1 is specifically designed to accommodate 3-pin 5.6mm diodes with the pinout illustrated below, and a dV/dI at lasing of 10 Ohms nominally (with 0-20 Ohms acceptable):

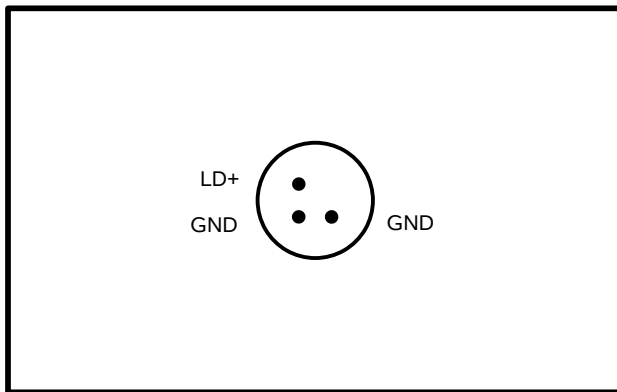

AVX-S1-P2-EX1 OUTPUT MODULE, SOCKET VIEW

**MATCHING USER-SUPPLIED
DIODE PACKAGES
(BOTTOM VIEW).
5.6 mm PACKAGE,
2.0 mm PIN CIRCLE DIAMETER**

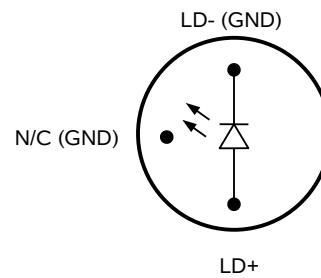

SPECIFICATIONS

Model:	AVX-S1-P2-EX1
Peak diode current (I_{PEAK}):	400 mA
Max. input amplitude:	20 Volts
Pulse width (PW):	0.4 ¹ - 200 ns
Rise time (20%-80%):	0.2 ns ¹
Pulse repetition frequency (PRF):	DC - 25 MHz
Max. bias current:	100 mA
Max. bias voltage:	50 Volts
Input impedance:	50 Ohms
N (transformer ratio ^{2,3}):	+1
$R_S + R_{DIODE}$:	50 Ohms
IN connector:	SMA female (one)
Maximum allowed power dissipation (in R_S) ⁷ :	$I_{PEAK}^2 \times R_S \times PW \times PRF \leq 1/2 \text{ Watt}$
Other connectors:	MV, MI: SMA (female), DC bias: solder terminal
Diode socket:	See later sections of this manual.
Dimensions:	H x W x D: 42 mm x 67 mm x 76 mm (1.6" x 2.6" x 3.0")
Material:	Cast aluminum, blue enamel

- 1) Lower pulse widths (to 0.2 ns) and faster rise times (0.1 ns) may be possible for laser diode packages with very low parasitic inductance. The -P0 and -P2 packages generally have very low inductance. The -P1, -P3, and -TO3 packages normally have somewhat higher parasitic inductance.
- 2) The transformer reduces the input voltage by a factor of N (approx) and increases the current by a factor of N (approx). The load resistance ($R_S + R_{DIODE}$) must equal $50\Omega / N^2$ (approx).
- 3) A polarity inverting option is available. Add the suffix -INV to the model number to specify this option. "N" is negative ($\approx -70\%$ of the standard value) when this option is installed.
- 4) Generic option. A drawing showing the diode package size and electrical pinout must be provided by the end-user, and the model number and price may change.
- 5) -P1B (specific pinout option). No further drawings are required. The socket will accept pins 8-14 of a standard butterfly package with 0.5 mm wide pins. A pulse will be applied to the diode anode (pin 10). Pins 8-9 and 11-13 will be grounded. Pin 14 will be made accessible through a solder terminal. Four mounting holes on a 8.9 x 26 mm grid will be provided. The diode parasitic resistance (dV/dI at lasing) must be < 1 Ohm. A low-bandwidth slide-on socket can also be provided for pins 1-7 of the diode, with the thermal control pins brought out to a standard DB-9 connector (-T1B option).
- 6) -P1C (specific pinout option). No further drawings are required. The socket will accept pins 8-14 of a standard butterfly package with 0.5 mm wide pins. A negative pulse will be applied to the diode cathode (pin 12). Pins 8-11 and 13-14 will be grounded. Four mounting holes on a 8.9 x 26 mm grid will be provided. The laser input impedance (dV/dI at lasing) must be 25 Ohms (+/- 5 Ohms). Not available on AVX-S3 models. A low-bandwidth slide-on socket can also be provided for pins 1-7 of the diode, with the thermal control pins brought out to a standard DB-9 connector (-T1C option).
- 7) Higher-power versions can sometimes be provided. Contact Avtech (info@avtechpulse.com) with your special requirement.
- 8) The AVX-S3A can generally be used successfully with 10 Ohm loads as well. Some applications use a slight impedance mismatch (10 Ω rather than the ideal 12.5 Ω) to obtain slightly higher output amplitudes. A small mismatch does not normally add significant waveform distortions or reflections.

REGULATORY NOTES

FCC PART 18

This device complies with part 18 of the FCC rules for non-consumer industrial, scientific and medical (ISM) equipment.

This instrument is enclosed in a rugged metal chassis and uses a filtered power entry module (where applicable). The main output signal is provided on a shielded connector that is intended to be used with shielded coaxial cabling and a shielded load. Under these conditions, the interference potential of this instrument is low.

If interference is observed, check that appropriate well-shielded cabling is used on the output connectors. Contact Avtech (info@avtechpulse.com) for advice if you are unsure of the most appropriate cabling. Also, check that your load is adequately shielded. It may be necessary to enclose the load in a metal enclosure.

If any of the connectors on the instrument are unused, they should be covered with shielded metal "dust caps" to reduce the interference potential.

This instrument does not normally require regular maintenance to minimize interference potential. However, if loose hardware or connectors are noted, they should be tightened. Contact Avtech (info@avtechpulse.com) if you require assistance.

EC DECLARATION OF CONFORMITY



We Avtech Electrosystems Ltd.
 P.O. Box 5120, LCD Merivale
 Ottawa, Ontario
 Canada K2C 3H4

declare that this pulse generator meets the intent of Directive 2004/108/EG for Electromagnetic Compatibility. Compliance pertains to the following specifications as listed in the official Journal of the European Communities:

EN 50081-1 Emission

EN 50082-1 Immunity

and that this pulse generator meets the intent of the Low Voltage Directive 72/23/EEC as amended by 93/68/EEC. Compliance pertains to the following specifications as listed in the official Journal of the European Communities:

EN 61010-1:2001 Safety requirements for electrical equipment for measurement, control, and laboratory use

DIRECTIVE 2002/95/EC (RoHS)

This instrument is exempt from Directive 2002/95/EC of the European Parliament and of the Council of 27 January 2003 on the Restriction of the use of certain Hazardous Substances (RoHS) in electrical and electronic equipment. Specifically, Avtech instruments are considered "Monitoring and control instruments" (Category 9) as defined in Annex 1A of Directive 2002/96/EC. The Directive 2002/95/EC only applies to Directive 2002/96/EC categories 1-7 and 10, as stated in the "Article 2 - Scope" section of Directive 2002/95/EC.

DIRECTIVE 2002/96/EC (WEEE)

European customers who have purchased this equipment directly from Avtech will have completed a "WEEE Responsibility Agreement" form, accepting responsibility for WEEE compliance (as mandated in Directive 2002/96/EC of the European Union and local laws) on behalf of the customer, as provided for under Article 9 of Directive 2002/96/EC.

Customers who have purchased Avtech equipment through local representatives should consult with the representative to determine who has responsibility for WEEE compliance. Normally, such responsibilities will lie with the representative, unless other arrangements (under Article 9) have been made.

Requirements for WEEE compliance may include registration of products with local governments, reporting of recycling activities to local governments, and financing of recycling activities.

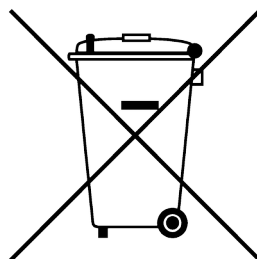

GENERAL INFORMATION

BASIC TEST ARRANGEMENT

To fully test the AVX-S1-P2-EX1, and for normal operation, the output module should be connected as shown below:

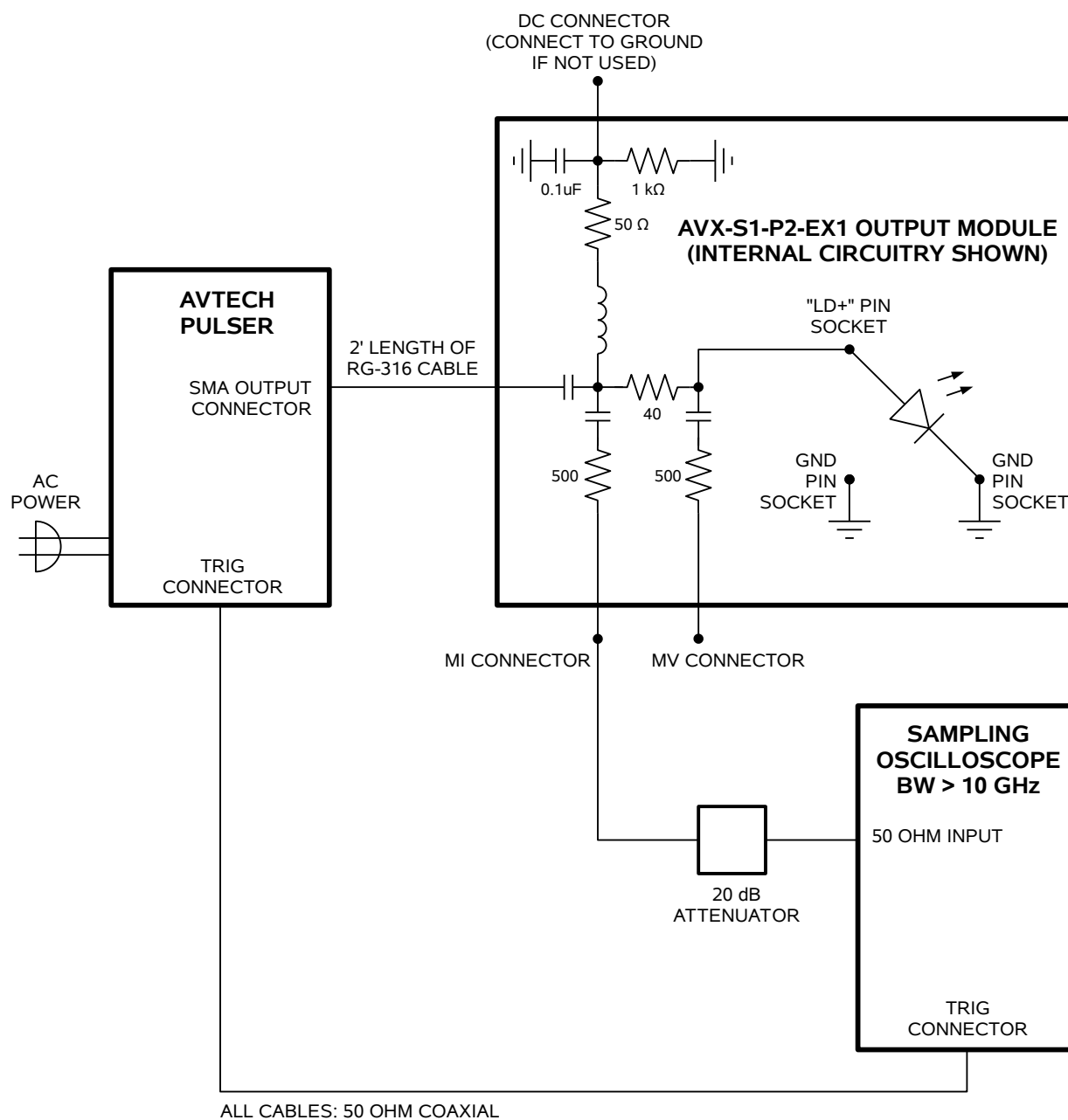

The diode load is inserted into the socket on the output module. The mechanical layout of the socket is shown below:

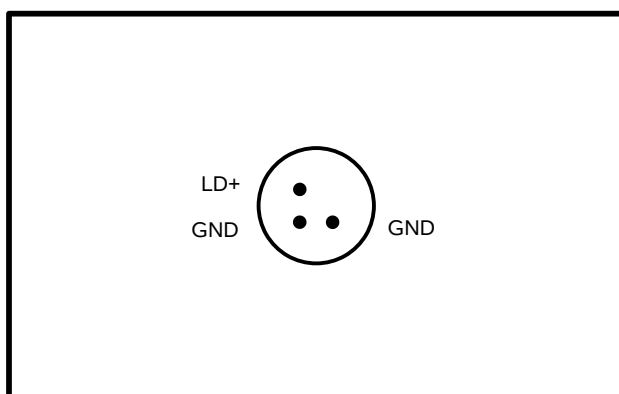

AVX-S1-P2-EX1 OUTPUT MODULE, SOCKET VIEW

**MATCHING USER-SUPPLIED
DIODE PACKAGES
(BOTTOM VIEW).
5.6 mm PACKAGE,
2.0 mm PIN CIRCLE DIAMETER**

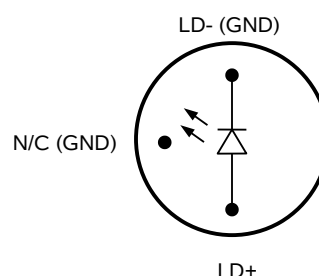

NOTE: Trim the diode leads to **no longer than 1.0 cm in length**. If the leads are longer than that, they may cause an internal short circuit in the output module, which may cause damage to the diode and the output module.

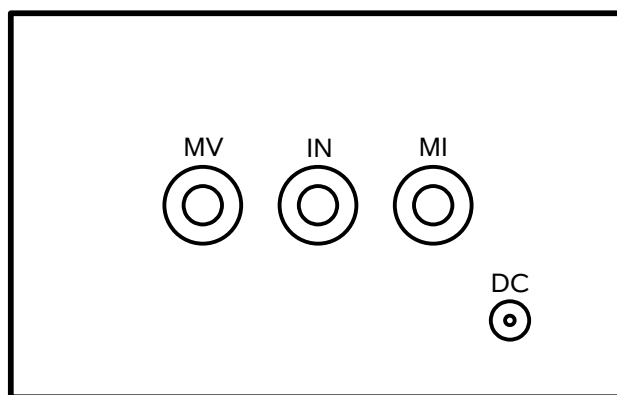

AVX-S1 OUTPUT MODULE, CONNECTOR VIEW

An oscilloscope may be used to monitor the MI and MV outputs, the locations of which are shown in the figure above. A forward DC bias may be applied to the laser diode by connecting a DC potential of 0 to +10 Volts to the DC solder terminal. The application of a small forward bias often yields a more ideal diode current waveform (as observed on the MI port). Note that the DC port must be shorted to ground if a bias is not applied.

AMPLITUDE CONTROL

When using the output module, the pulse current through the diode load is given by:

$$I_{\text{DIODE}} = (V_{\text{SET}} - V_{\text{DIODE}}) / (40\Omega + R_{\text{DIODE}})$$

where V_{SET} is the amplitude setting on the mainframe (typically between 0 and +20V), V_{DIODE} is the forward voltage drop across the diode (typically 2 to 3V), and R_{DIODE} is the diode dV/dI at lasing (ideally 10 Ohms, with 0-20 Ohms being acceptable). The 40Ω resistance is built into the AVX-S1-P2-EX1 output module.

COMPATIBLE PULSE GENERATORS

The AVX-S1-P2-EX1 is designed for use with high-speed Avtech pulse generators, such as those the in the AVP, AVPP, AVM, AVMP, AVMM, AVMR, AVN, and other families. The AVX-S1-P2-EX1 may also be suitable for use with other pulse generators. Contact Avtech (info@avtechpulse.com) if you need assistance selecting a pulse generator.

Models in the Avtech AVO-9 series include a pulse generator and an AVX-S series output module in a complete “bundle”. See <http://www.avtechpulse.com/laser/> for details.