



AVTECH ELECTROSYSTEMS LTD.

NANOSECOND WAVEFORM ELECTRONICS
SINCE 1975

P.O. BOX 265
OGDENSBURG, NY
U.S.A. 13669-0265

TEL: 888-670-8729 (USA & Canada) or +1-613-686-6675 (Intl)
FAX: 800-561-1970 (USA & Canada) or +1-613-686-6679 (Intl)

info@avtechpulse.com - <http://www.avtechpulse.com/>

BOX 5120, LCD MERIVALE
OTTAWA, ONTARIO
CANADA K2C 3H4

INSTRUCTIONS

MODELS AVX-TFR-RSMB-TO220

TEST JIG FOR USE WITH

AVTECH AVR-EBF6-B

FORWARD RECOVERY TEST SYSTEMS

SERIAL NUMBER: _____

WARRANTY

Avtech Electrosystems Ltd. warrants products of its manufacture to be free from defects in material and workmanship under conditions of normal use. If, within one year after delivery to the original owner, and after prepaid return by the original owner, this Avtech product is found to be defective, Avtech shall at its option repair or replace said defective item. This warranty does not apply to units which have been disassembled, modified or subjected to conditions exceeding the applicable specifications or ratings. This warranty is the extent of the obligation assumed by Avtech with respect to this product and no other warranty or guarantee is either expressed or implied.

TECHNICAL SUPPORT

Phone: 888-670-8729 (USA & Canada) or +1-613-686-6675 (International)

Fax: 800-561-1970 (USA & Canada) or +1-613-686-6679 (International)

E-mail: info@avtechpulse.com

World Wide Web: <http://www.avtechpulse.com>

TABLE OF CONTENTS

WARRANTY.....2

TECHNICAL SUPPORT.....2

TABLE OF CONTENTS.....3

INTRODUCTION.....4

CONNECTOR CHANGES.....4

EUROPEAN REGULATORY NOTES.....5

EC DECLARATION OF CONFORMITY.....5

DIRECTIVE 2002/95/EC (RoHS).....5

DIRECTIVE 2002/96/EC (WEEE).....5

BASIC AMPLITUDE CONTROL.....7

SETTING THE AMPLITUDE LEVELS.....8

AMPLITUDE ACCURACY.....9

INCORRECT ORIENTATION.....9

CABLE LENGTHS.....9

ACCESSIBLE VOLTAGES.....9

TEST JIG MECHANICAL ASPECTS..... 10

SAFETY INTERLOCK..... 12

WIRING DIAGRAM..... 13

Manual Reference: /files/server1/officefiles/instructword/avx-tfr/AVX-TFR-RSMB-TO220,ed1.odt.
Last modified February 29, 2024.
Copyright © 2024 Avtech Electrosystems Ltd, All Rights Reserved.

INTRODUCTION

The AVX-TFR-RSMB-TO220 test jig is designed for use with the AVR-EBF6-B series of forward recovery time test systems. The AVX-TFR-RSMB-TO220 is specifically designed to accept TO-220AB (three pin) and TO-220AC (two pin) devices. It will also accept a range of larger devices, such as TO-247 and TO-268 packages.

The test jig contains three different 3 pin sockets, which are wired in parallel, but with different pin assignments. The user should select the socket that matches the pinout of the device to be tested, and orient the device appropriately. The pin assignments are shown below:

BACK OF JIG (HINGED SIDE)

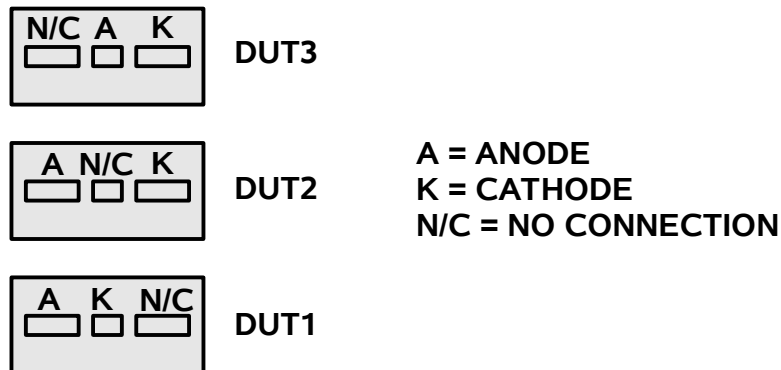

FRONT OF JIG

This test jig can be used as a replacement or an alternative for the test jigs originally supplied with the Avtech AVR-EBF6-B units.

CONNECTOR CHANGES

AVX-TFR units made in 2009 and later use BNC signal connectors. Earlier versions had SMA connectors. Units that are supplied for use with existing systems may be provided with BNC-to-SMA adapters, as appropriate.

EUROPEAN REGULATORY NOTES

EC DECLARATION OF CONFORMITY

We Avtech Electrosystems Ltd.
P.O. Box 5120, LCD Merivale
Ottawa, Ontario
Canada K2C 3H4

declare that this pulse generator meets the intent of Directive 89/336/EEC for Electromagnetic Compatibility. Compliance pertains to the following specifications as listed in the official Journal of the European Communities:

EN 50081-1 Emission

EN 50082-1 Immunity

and that this pulse generator meets the intent of the Low Voltage Directive 72/23/EEC as amended by 93/68/EEC. Compliance pertains to the following specifications as listed in the official Journal of the European Communities:

EN 61010-1:2001 Safety requirements for electrical equipment for measurement, control, and laboratory use



DIRECTIVE 2002/95/EC (RoHS)

This instrument is exempt from Directive 2002/95/EC of the European Parliament and of the Council of 27 January 2003 on the Restriction of the use of certain Hazardous Substances (RoHS) in electrical and electronic equipment. Specifically, Avtech instruments are considered "Monitoring and control instruments" (Category 9) as defined in Annex 1A of Directive 2002/96/EC. The Directive 2002/95/EC only applies to Directive 2002/96/EC categories 1-7 and 10, as stated in the "Article 2 - Scope" section of Directive 2002/95/EC.

DIRECTIVE 2002/96/EC (WEEE)

European customers who have purchased this equipment directly from Avtech will have completed a "WEEE Responsibility Agreement" form, accepting responsibility for WEEE

compliance (as mandated in Directive 2002/96/EC of the European Union and local laws) on behalf of the customer, as provided for under Article 9 of Directive 2002/96/EC.

Customers who have purchased Avtech equipment through local representatives should consult with the representative to determine who has responsibility for WEEE compliance. Normally, such responsibilities will lie with the representative, unless other arrangements (under Article 9) have been made.

Requirements for WEEE compliance may include registration of products with local governments, reporting of recycling activities to local governments, and financing of recycling activities.

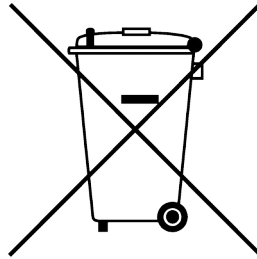

BASIC AMPLITUDE CONTROL

The AVX-TFR-RSMB-TO220 is intended for use with an Avtech AVR-EBF6-B forward recovery test system, ordered separately. Please refer to the manual supplied with the AVR-EBF6-B instrument for detailed usage instructions.

An example configuration suitable for use with the AVR-EBF6-B is shown in the figure below.

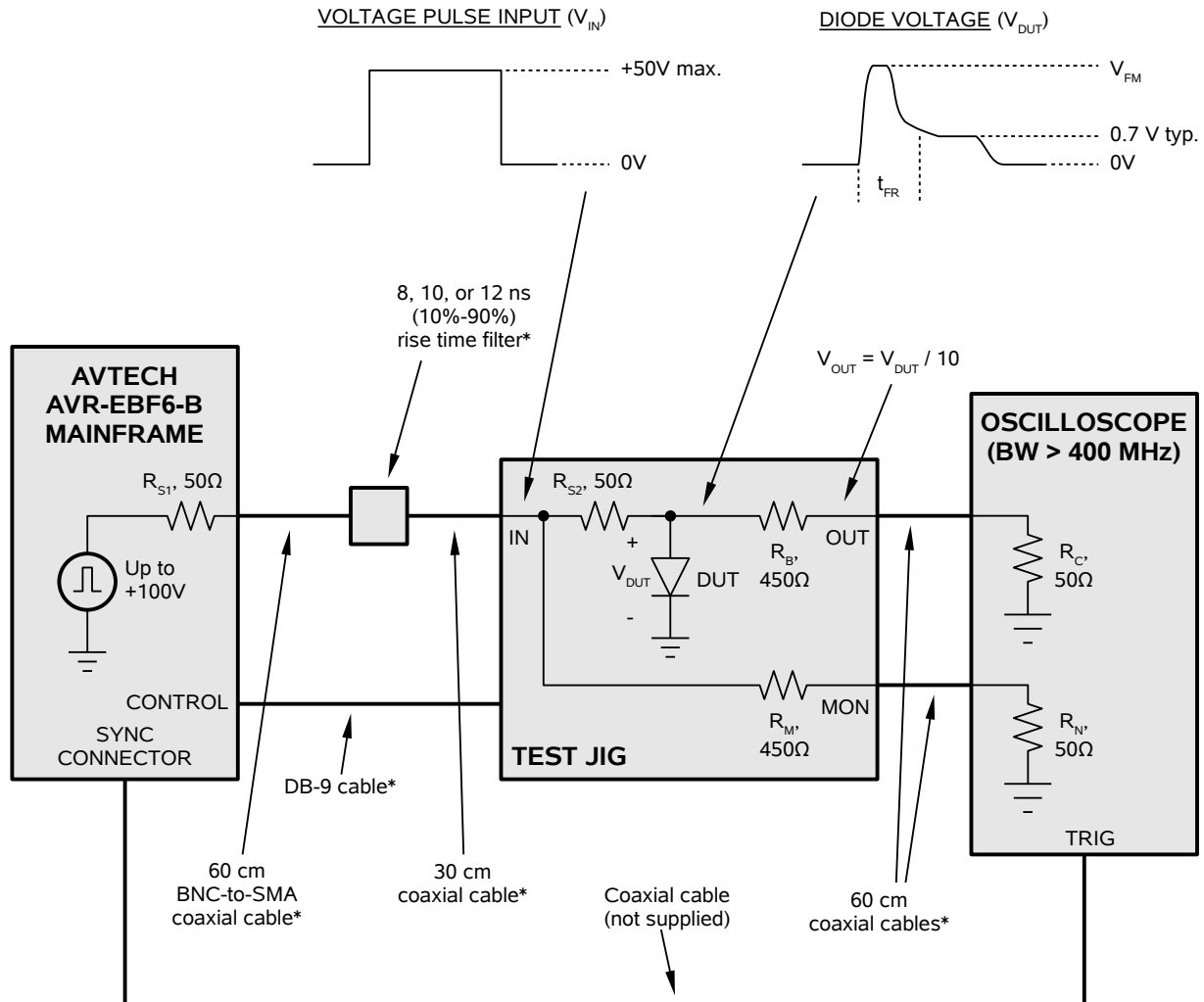

* These items are supplied with the AVR-EBF6-B. They are not supplied with separately-ordered AVX-TFR test jigs.

The mainframe connects to the rise time filter using a 60 cm length of coaxial cable.

The output of the filter connects to the test jig using a 30 cm length of coaxial cable.

A DB-9 control cable connects the mainframe to the test jig, to control the safety interlocks.

The test jig main output is fed into the 50 Ohm input of an oscilloscope by a 60 cm length of coaxial cable, as is the monitor output.

The SYNC output of the mainframe should be used to trigger the oscilloscope.

⚠ A 50 Ohm resistance (R_C in the diagram above) must be connected to ground on the output. This can be a discrete resistor, a feed-through terminator, or the input impedance of an oscilloscope (the latter method is shown in the diagram). If a high-speed sampling oscilloscope is used, the input should be protected by adding attenuator on the input.

The 450 Ohm resistance in series with the test jig output and the 50 Ohm input impedance of the oscilloscope form a 10:1 voltage, so the measured voltage is:

$$V_{OUT} = V_{DUT} / 10$$

The monitor output is similarly divided by a factor of 10, so that:

$$V_{MON} = V_{IN} / 10$$

The monitor output is provided so that the user may determine the starting point of the transient.

SETTING THE AMPLITUDE LEVELS

The amplitude pulse may be set from the front panel of the instrument, or by computer command. This amplitude is expressed in terms of the voltage present on the test jig input.

The amplitude is related to the forward diode current by:

$$I_F \approx (V_{IN} - V_{DUT}) / 50\Omega$$

where V_{DUT} is the forward voltage drop of the diode (typically 0.7V for the classic silicon PN junction diode, and usually somewhat lower for a Schottky diode).

For instance, if the desired forward current amplitude is 500 mA, the amplitude should be set at 25.7V, so that $(25.7V - 0.7V) / 50\Omega = 500$ mA. It may be necessary to adjust the amplitude iteratively to obtain the desired I_F , since V_{DUT} may not be known in advance.

AMPLITUDE ACCURACY

 Due to the variations in V_F as a function of operating conditions, the amplitude settings *should not be relied upon for any degree of accuracy*. Instead the voltage at the OUT terminal on the test jig should be monitored with a calibrated oscilloscope.

R_B can be measured directly on the test jig (with the test jig disconnected) to determine calibrated relationships, if desired. R_C is provided by the user, and can be calibrated as required.

INCORRECT ORIENTATION

The instrument and the DUT will not be damaged if the diode is installed with the incorrect orientation (i.e., with the anode and cathode reversed). However, incorrect waveforms will be generated,

CABLE LENGTHS

The cable lengths are not critical. They may be increased or decreased as desired.

The cables connecting the OUT and MON signals to the oscilloscope should have identical lengths, to avoid introducing timing skews.

ACCESSIBLE VOLTAGES

The mainframe provides pulsed voltages of up to 100V to the test jig. For this reason, the output is automatically disabled when the test jig lid is open. The lid must be closed to obtain measurements.

 Shielded cabling should be used for all connections to the "IN" and "OUT" terminals on the test jig, and the "OUT" connector on the mainframe.

 When used properly (with $R_C = 50$ Ohms), the maximum voltage on the OUT terminal will be $< 1V$, approximately. However, if R_C is not connected and the DUT is not installed, the maximum voltage will at the OUT terminal may be as high as 100V. You may need to consider whether this scenario would damage your oscilloscope, and take appropriate precautions.

TEST JIG MECHANICAL ASPECTS

The AVX-TFR-RSMB-TO220 is specifically designed to accept TO-220AB (three pin) and TO-220AC (two pin) devices. It will also accept a range of larger devices, such as TO-247 and TO-268 packages.

The test jig contains three different 3 pin sockets, which are wired in parallel, but with different pin assignments. The user should select the socket that matches the pinout of the device to be tested, and orient the device appropriately. The pin assignments are shown below:

BACK OF JIG (HINGED SIDE)



A = ANODE
K = CATHODE
N/C = NO CONNECTION



FRONT OF JIG

The full AVX-TFR-RSMB-TO220 test jig is shown below:



The IN, MON, OUT, and CONTROL connectors are on the rear of the jig, below the hinges:



SAFETY INTERLOCK

The AVX-TFR-RSMB-TO220 contains safety interlock devices, for use with the AVR-EBF6-B mainframe. The DB-9 female "CONTROL" connector should be connected to the corresponding connector on the AVR-EBF6-B mainframe using the straight-through DB-9 cable supplied with the AVR-EBF6-B.

The DB9 "CONTROL" connector pinout is as follows:

Pin 1 - To test jig switch 1.

Pin 2 - To test jig switch 2.

Pin 5 - Ground.

Pin 6 - To test jig switch 1.

Pin 7 - To test jig switch 2.

Pin 9 - Safety sensor power supply (+15V through 680 Ohms).

When the test jig lid is safely closed, Pin 1 is shorted to Pin 6, and Pin 2 is shorted to Pin 7. Switch 1 is a passive mechanical switch. Switch 2 is an active photosensor, which requires power from Pin 9.

WIRING DIAGRAM

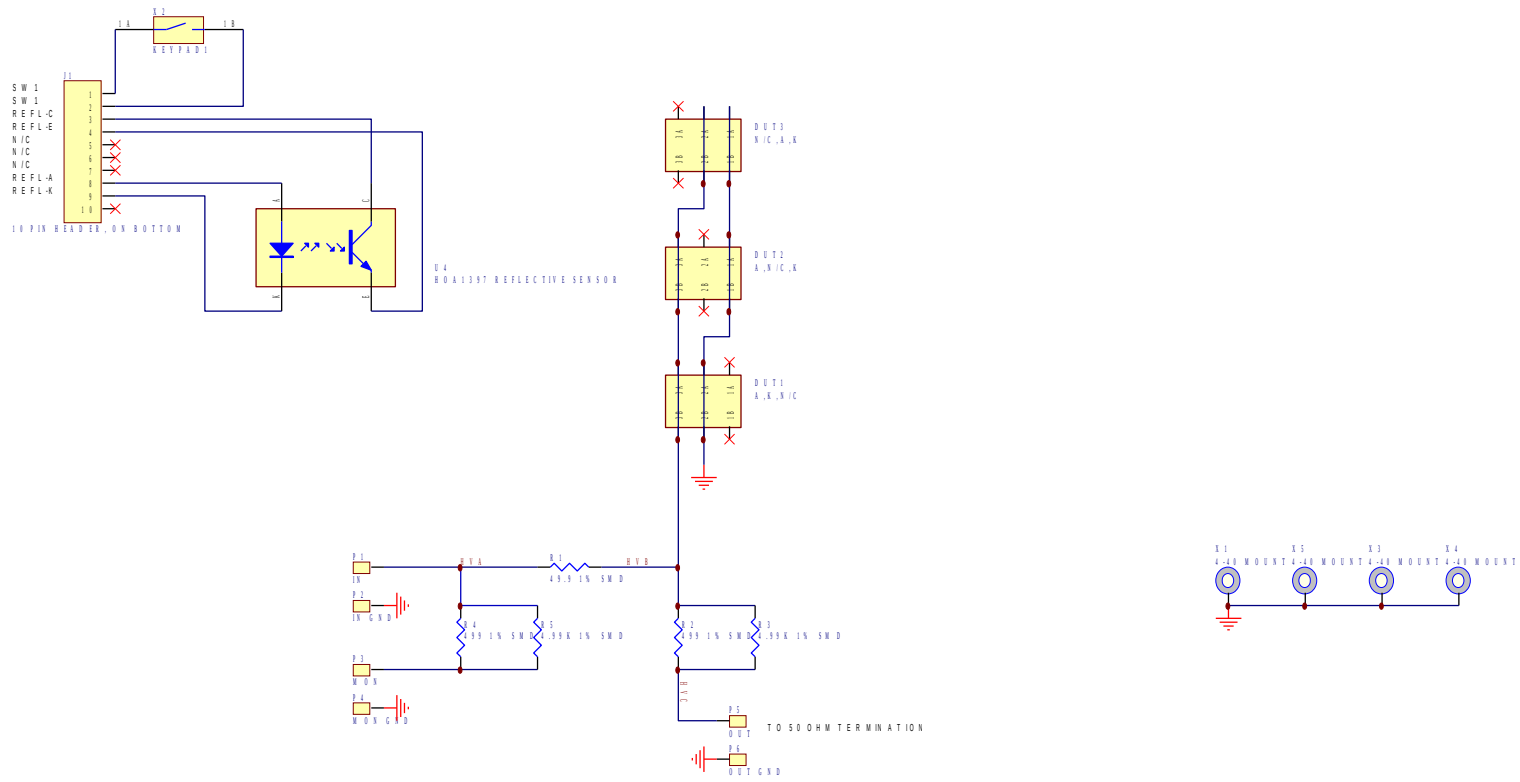

AVX-TFR-RSMB-TO 220	
Printed 15-Jun-2009	Revision 1A
Z:\m\jcf\es\p\ch1289\lfr-jigs\040 - Documents\RSMB-TO 220\IPC B199-RSMB-TO 02	