



AVTECH ELECTROSYSTEMS LTD.

NANOSECOND WAVEFORM ELECTRONICS
SINCE 1975

P.O. BOX 265
OGDENSBURG, NY
U.S.A. 13669-0265

TEL: 888-670-8729 (USA & Canada) or +1-613-686-6675 (Intl)
FAX: 800-561-1970 (USA & Canada) or +1-613-686-6679 (Intl)

info@avtechpulse.com - <http://www.avtechpulse.com/>

BOX 5120, LCD MERIVALE
OTTAWA, ONTARIO
CANADA K2C 3H4

INSTRUCTIONS

MODEL AVX-TFR-STUD
TEST JIG FOR USE WITH
AVTECH AVR-EBF6-B
FORWARD RECOVERY TEST SYSTEMS

SERIAL NUMBER: _____

WARRANTY

Avtech Electrosystems Ltd. warrants products of its manufacture to be free from defects in material and workmanship under conditions of normal use. If, within one year after delivery to the original owner, and after prepaid return by the original owner, this Avtech product is found to be defective, Avtech shall at its option repair or replace said defective item. This warranty does not apply to units which have been disassembled, modified or subjected to conditions exceeding the applicable specifications or ratings. This warranty is the extent of the obligation assumed by Avtech with respect to this product and no other warranty or guarantee is either expressed or implied.

TECHNICAL SUPPORT

Phone: 888-670-8729 (USA & Canada) or +1-613-686-6675 (International)

Fax: 800-561-1970 (USA & Canada) or +1-613-686-6679 (International)

E-mail: info@avtechpulse.com

World Wide Web: <http://www.avtechpulse.com>

TABLE OF CONTENTS

WARRANTY.....2

TECHNICAL SUPPORT.....2

TABLE OF CONTENTS.....3

INTRODUCTION.....4

REGULATORY NOTES.....5

 FCC PART 18.....5

 EC DECLARATION OF CONFORMITY.....5

 DIRECTIVE 2011/65/EU (RoHS).....6

 DIRECTIVE 2002/96/EC (WEEE).....6

BASIC AMPLITUDE CONTROL.....8

 SETTING THE AMPLITUDE LEVELS.....9

 AMPLITUDE ACCURACY.....10

 INCORRECT ORIENTATION.....10

 CABLE LENGTHS.....10

 ACCESSIBLE VOLTAGES.....10

TEST JIG MECHANICAL ASPECTS.....11

SAFETY INTERLOCK.....14

WIRING DIAGRAM.....15

Manual Reference: /files/server1/officefiles/instructword/avx-tfr/AVX-TFR-STUD,ed1.odt.
Last modified February 29, 2024.
Copyright © 2024 Avtech Electrosystems Ltd, All Rights Reserved.

INTRODUCTION

The AVX-TFR-STUD test jig is designed for use with the AVR-EBF6-B series of forward recovery time test systems, and it is designed to accept DO-4 and DO-5 standard and reverse-polarity stud packages.

This test jig can be used as a replacement or an alternative for the test jigs originally supplied with the Avtech AVR-EBF6-B units.

REGULATORY NOTES

FCC PART 18

This device complies with part 18 of the FCC rules for non-consumer industrial, scientific and medical (ISM) equipment.

This instrument is enclosed in a rugged metal chassis and uses a filtered power entry module (where applicable). The main output signal is provided on a shielded connector that is intended to be used with shielded coaxial cabling and a shielded load. Under these conditions, the interference potential of this instrument is low.

If interference is observed, check that appropriate well-shielded cabling is used on the output connectors. Contact Avtech (info@avtechpulse.com) for advice if you are unsure of the most appropriate cabling. Also, check that your load is adequately shielded. It may be necessary to enclose the load in a metal enclosure.

If any of the connectors on the instrument are unused, they should be covered with shielded metal "dust caps" to reduce the interference potential.

This instrument does not normally require regular maintenance to minimize interference potential. However, if loose hardware or connectors are noted, they should be tightened. Contact Avtech (info@avtechpulse.com) if you require assistance.

EC DECLARATION OF CONFORMITY



We Avtech Electrosystems Ltd.
 P.O. Box 5120, LCD Merivale
 Ottawa, Ontario
 Canada K2C 3H5

declare that this pulse generator meets the intent of Directive 2004/108/EG for Electromagnetic Compatibility. Compliance pertains to the following specifications as listed in the official Journal of the European Communities:

EN 50081-1 Emission

EN 50082-1 Immunity

and that this pulse generator meets the intent of the Low Voltage Directive 2006/95/EC. Compliance pertains to the following specifications as listed in the official Journal of the European Communities:

EN 61010-1:2001 Safety requirements for electrical equipment for measurement, control, and laboratory use

DIRECTIVE 2011/65/EU (RoHS)

We Avtech Electrosystems Ltd.
P.O. Box 5120, LCD Merivale
Ottawa, Ontario
Canada K2C 3H5

declare that, to the best of our knowledge, all electrical and electronic equipment (EEE) sold by the company are in compliance with Directive 2011/65/EU of the European Parliament and of the Council of 8 June 2011 on the restriction of the use of certain hazardous substances in electrical and electronic equipment (also known as “RoHS Recast”). In addition, this declaration of conformity is issued under the sole responsibility of Avtech Electrosystems Ltd. Specifically, products manufactured do not contain the substances listed in the table below in concentrations greater than the listed maximum value.

<i>Material/Substance</i>	<i>Threshold level</i>
Lead (Pb)	< 1000 ppm (0.1% by mass)
Mercury (Hg)	< 1000 ppm (0.1% by mass)
Hexavalent Chromium (Cr6+)	< 1000 ppm (0.1% by mass)
Polybrominated Biphenyls (PBB)	< 1000 ppm (0.1% by mass)
Polybrominated Diphenyl ethers (PBDE)	< 1000 ppm (0.1% by mass)
Cadmium (Cd)	< 100 ppm (0.01% by mass)

DIRECTIVE 2002/96/EC (WEEE)

European customers who have purchased this equipment directly from Avtech will have completed a “WEEE Responsibility Agreement” form, accepting responsibility for WEEE compliance (as mandated in Directive 2002/96/EC of the European Union and local laws) on behalf of the customer, as provided for under Article 9 of Directive 2002/96/EC.

Customers who have purchased Avtech equipment through local representatives should consult with the representative to determine who has responsibility for WEEE

compliance. Normally, such responsibilities will lie with the representative, unless other arrangements (under Article 9) have been made.

Requirements for WEEE compliance may include registration of products with local governments, reporting of recycling activities to local governments, and financing of recycling activities.

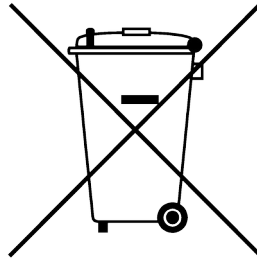

BASIC AMPLITUDE CONTROL

The AVX-TFR-STUD is intended for use with an Avtech AVR-EBF6-B forward recovery test system, ordered separately. Please refer to the manual supplied with the AVR-EBF6-B instrument for detailed usage instructions.

An example configuration suitable for use with the AVR-EBF6-B is shown in the figure below.

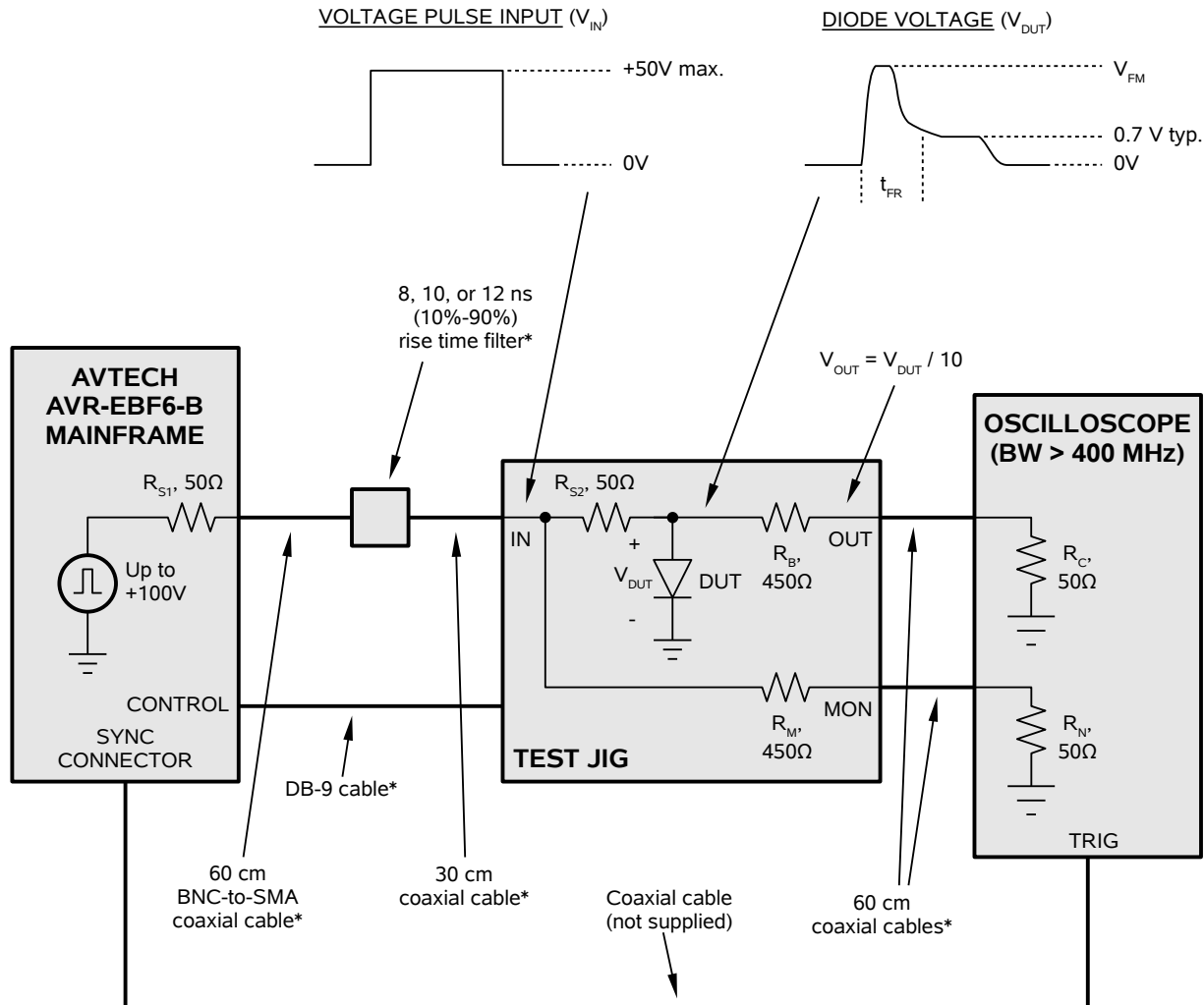

* These items are supplied with the AVR-EBF6-B. They are not supplied with separately-ordered AVX-TFR test jigs.

The mainframe connects to the rise time filter using a 60 cm length of coaxial cable.

The output of the filter connects to the test jig using a 30 cm length of coaxial cable.

A DB-9 control cable connects the mainframe to the test jig, to control the safety interlocks.

The test jig main output is fed into the 50 Ohm input of an oscilloscope by a 60 cm length of coaxial cable, as is the monitor output.

The SYNC output of the mainframe should be used to trigger the oscilloscope.

⚠ A 50 Ohm resistance (R_C in the diagram above) must be connected to ground on the output. This can be a discrete resistor, a feed-through terminator, or the input impedance of an oscilloscope (the latter method is shown in the diagram). If a high-speed sampling oscilloscope is used, the input should be protected by adding attenuator on the input.

The 450 Ohm resistance in series with the test jig output and the 50 Ohm input impedance of the oscilloscope form a 10:1 voltage, so the measured voltage is:

$$V_{OUT} = V_{DUT} / 10$$

The monitor output is similarly divided by a factor of 10, so that:

$$V_{MON} = V_{IN} / 10$$

The monitor output is provided so that the user may determine the starting point of the transient.

SETTING THE AMPLITUDE LEVELS

The amplitude pulse may be set from the front panel of the instrument, or by computer command. This amplitude is expressed in terms of the voltage present on the test jig input.

The amplitude is related to the forward diode current by:

$$I_F \approx (V_{IN} - V_{DUT}) / 50\Omega$$

where V_{DUT} is the forward voltage drop of the diode (typically 0.7V for the classic silicon PN junction diode, and usually somewhat lower for a Schottky diode).

For instance, if the desired forward current amplitude is 500 mA, the amplitude should be set at 25.7V, so that $(25.7V - 0.7V) / 50\Omega = 500$ mA. It may be necessary to adjust the amplitude iteratively to obtain the desired I_F , since V_{DUT} may not be known in advance.

AMPLITUDE ACCURACY

 Due to the variations in V_F as a function of operating conditions, the amplitude settings *should not be relied upon for any degree of accuracy*. Instead the voltage at the OUT terminal on the test jig should be monitored with a calibrated oscilloscope.

R_B can be measured directly on the test jig (with the test jig disconnected) to determine calibrated relationships, if desired. R_C is provided by the user, and can be calibrated as required.

INCORRECT ORIENTATION

The instrument and the DUT will not be damaged if the diode is installed with the incorrect orientation (i.e., with the anode and cathode reversed). However, incorrect waveforms will be generated,

CABLE LENGTHS

The cable lengths are not critical. They may be increased or decreased as desired.

The cables connecting the OUT and MON signals to the oscilloscope should have identical lengths, to avoid introducing timing skews.

ACCESSIBLE VOLTAGES

The mainframe provides pulsed voltages of up to 100V to the test jig. For this reason, the output is automatically disabled when the test jig lid is open. The lid must be closed to obtain measurements.

 Shielded cabling should be used for all connections to the "IN" and "OUT" terminals on the test jig, and the "OUT" connector on the mainframe.

 When used properly (with $R_C = 50$ Ohms), the maximum voltage on the OUT terminal will be $< 1V$, approximately. However, if R_C is not connected and the DUT is not installed, the maximum voltage will at the OUT terminal may be as high as 100V. You may need to consider whether this scenario would damage your oscilloscope, and take appropriate precautions.

TEST JIG MECHANICAL ASPECTS

The AVX-TRR-STUD accepts DO-4 and DO-5 standard and reverse-polarity stud packages. The test jig is shown below:



The photo below shows a reverse-polarity DO-4 diode (the Ruttonsha 12FLR60/F05) installed between the four spring-loaded contacts (two for the anode end, and two for the cathode end):

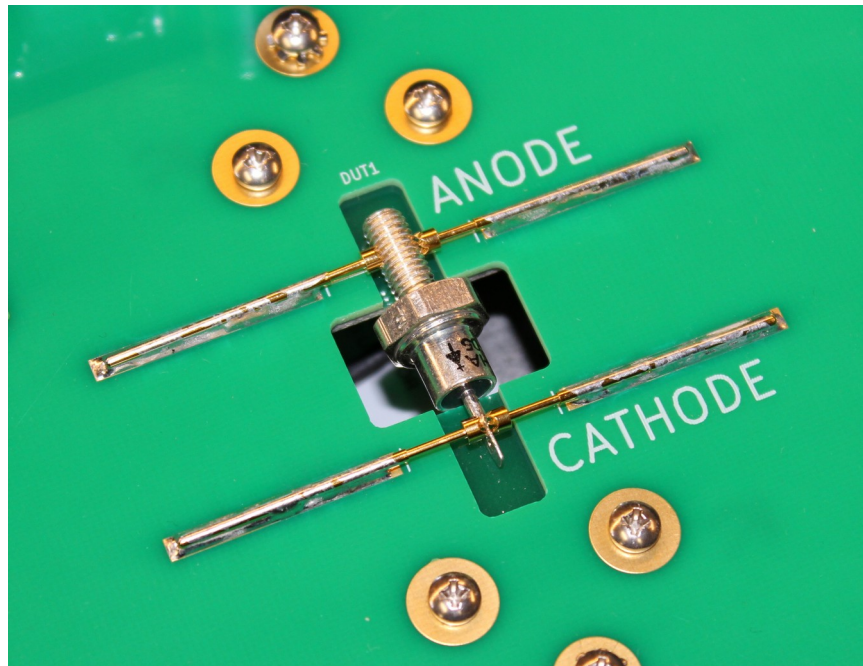

To install the diode, spread apart one pair of spring pins with your fingers or tweezers, and insert one end of the diode. Repeat on the other end.

The photo below shows a normal-polarity DO-5 diode (the Ruttonsha 40HF80) installed between the four spring-loaded contacts (two for the anode end, and two for the cathode end):

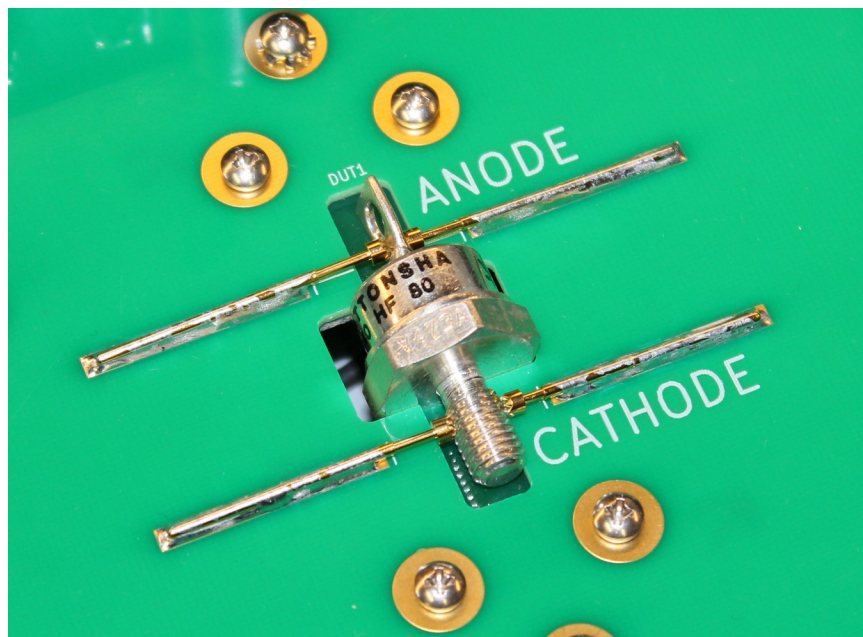

The IN, OUT, MON, and CONTROL connectors are on the rear of the jig, below the hinges:



SAFETY INTERLOCK

The AVX-TFR-STUD contains safety interlock devices, for use with the AVR-EBF6-B mainframe. The DB-9 female "CONTROL" connector should be connected to the corresponding connector on the AVR-EBF6-B mainframe using the straight-through DB-9 cable supplied with the AVR-EBF6-B.

The DB9 "CONTROL" connector pinout is as follows:

Pin 1 - To test jig switch 1.

Pin 2 - To test jig switch 2.

Pin 5 - Ground.

Pin 6 - To test jig switch 1.

Pin 7 - To test jig switch 2.

Pin 9 - Safety sensor power supply (+15V through 680 Ohms).

When the test jig lid is safely closed, Pin 1 is shorted to Pin 6, and Pin 2 is shorted to Pin 7. Switch 1 is a passive mechanical switch. Switch 2 is an active photosensor, which requires power from Pin 9.

WIRING DIAGRAM

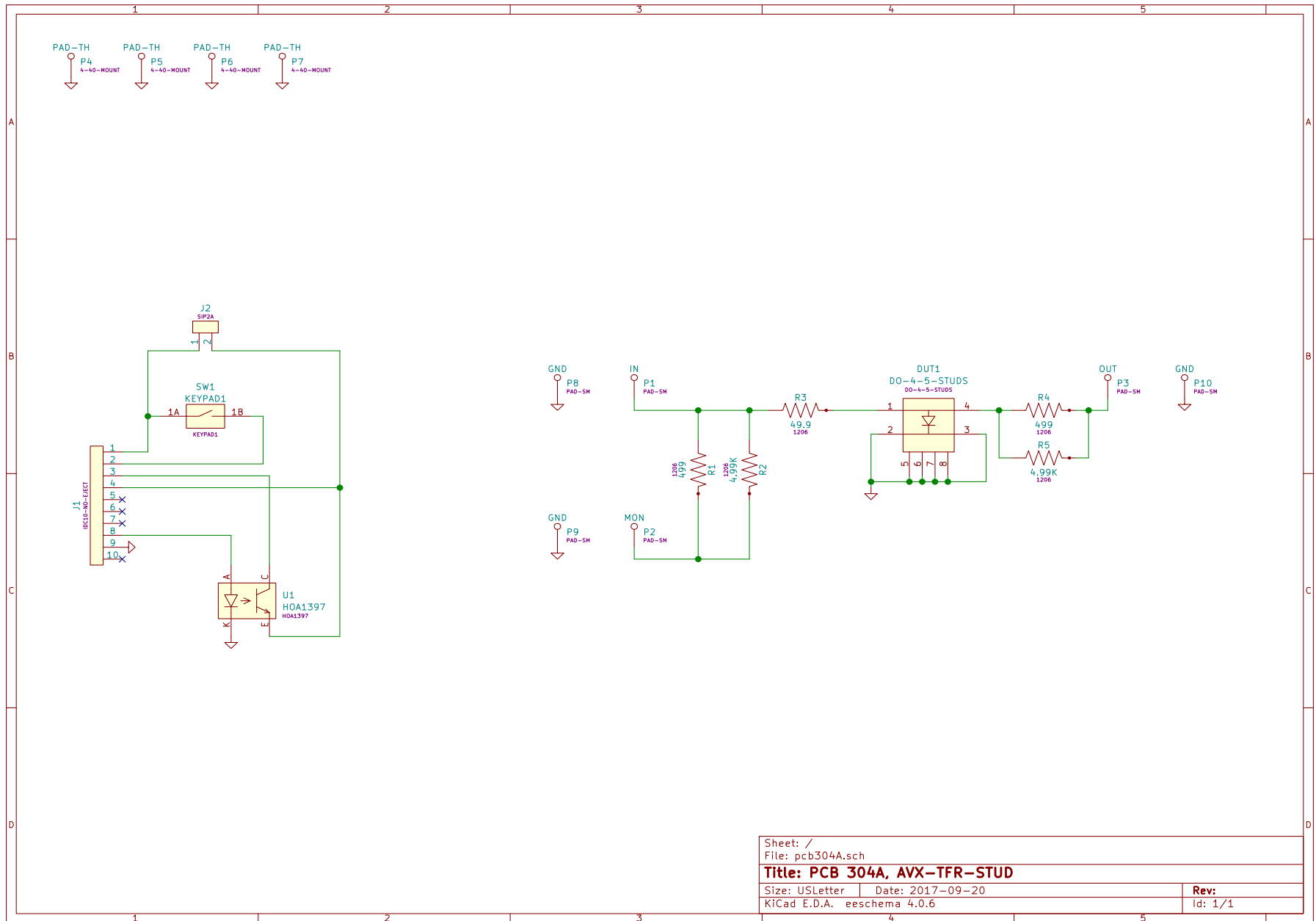

Sheet: /	
File: pcb304A.sch	
Title: PCB 304A, AVX-TFR-STUD	
Size: USLetter	Date: 2017-09-20
KiCad E.D.A. eeschema 4.0.6	Rev: 1/1