



AVTECH ELECTROSYSTEMS LTD.

NANOSECOND WAVEFORM ELECTRONICS  
SINCE 1975

P.O. BOX 265  
OGDENSBURG, NY  
U.S.A. 13669-0265

TEL: 888-670-8729 (USA & Canada) or +1-613-226-5772 (Intl)  
FAX: 800-561-1970 (USA & Canada) or +1-613-226-2802 (Intl)

info@avtechpulse.com - <http://www.avtechpulse.com/>

BOX 5120, LCD MERIVALE  
OTTAWA, ONTARIO  
CANADA K2C 3H4

## INSTRUCTIONS

MODELS AVX-TRR-BTA  
TEST JIG FOR USE WITH  
AVTECH AVR-EB4-B  
REVERSE RECOVERY TEST SYSTEMS

SERIAL NUMBER: \_\_\_\_\_

### WARRANTY

Avtech Electrosystems Ltd. warrants products of its manufacture to be free from defects in material and workmanship under conditions of normal use. If, within one year after delivery to the original owner, and after prepaid return by the original owner, this Avtech product is found to be defective, Avtech shall at its option repair or replace said defective item. This warranty does not apply to units which have been disassembled, modified or subjected to conditions exceeding the applicable specifications or ratings. This warranty is the extent of the obligation assumed by Avtech with respect to this product and no other warranty or guarantee is either expressed or implied.

### TECHNICAL SUPPORT

Phone: 888-670-8729 (USA & Canada) or +1-613-226-5772 (Intl)

Fax: 800-561-1970 (USA & Canada) or +1-613-226-2802 (Intl)

E-mail: [info@avtechpulse.com](mailto:info@avtechpulse.com)

World Wide Web: <http://www.avtechpulse.com>

TABLE OF CONTENTS

**WARRANTY.....2**

**TECHNICAL SUPPORT.....2**

**TABLE OF CONTENTS.....3**

**INTRODUCTION.....4**

**MODEL NUMBER HISTORY.....4**

**EUROPEAN REGULATORY NOTES.....5**

**EC DECLARATION OF CONFORMITY.....5**

**DIRECTIVE 2002/95/EC (RoHS).....5**

**DIRECTIVE 2002/96/EC (WEEE).....5**

**BASIC AMPLITUDE CONTROL.....7**

**SETTING THE AMPLITUDE LEVELS.....8**

**AMPLITUDE ACCURACY.....9**

**INCORRECT ORIENTATION.....9**

**ACCESSIBLE VOLTAGES.....9**

**TEST JIG MECHANICAL ASPECTS.....10**

**SAFETY INTERLOCK.....13**

**TYPICAL RESULTS.....14**

**WIRING DIAGRAM.....15**

Manual Reference: /files/server1/officefiles/instructword/avx-trr/AVX-TRR-BTA,ed1.odt.  
Last modified February 29, 2024.  
Copyright © 2024 Avtech Electrosystems Ltd, All Rights Reserved.

## INTRODUCTION

The AVX-TRR-BTA test jig is designed for use with the AVR-EB4-B series of reverse recovery time test systems. The AVX-TRR-BTA accepts the unusual package shown below:

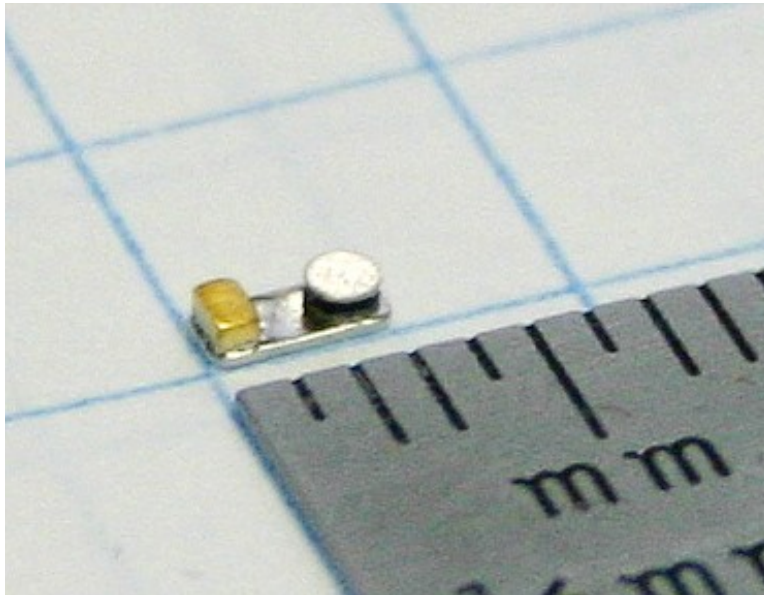

This test jig can be used as a replacement or an alternative for the test jigs originally supplied with the Avtech AVR-EB4-B units.

## MODEL NUMBER HISTORY

The AVX-TRR-BTA was originally supplied as an included accessory with the AVR-EB4-B-BTA test system. The AVX-TRR-BTA may also be ordered separately (in which case it is supplied with this manual).

## EUROPEAN REGULATORY NOTES

### EC DECLARATION OF CONFORMITY

We Avtech Electrosystems Ltd.  
P.O. Box 5120, LCD Merivale  
Ottawa, Ontario  
Canada K2C 3H4

declare that this pulse generator meets the intent of Directive 89/336/EEC for Electromagnetic Compatibility. Compliance pertains to the following specifications as listed in the official Journal of the European Communities:

EN 50081-1 Emission

EN 50082-1 Immunity

and that this pulse generator meets the intent of the Low Voltage Directive 72/23/EEC as amended by 93/68/EEC. Compliance pertains to the following specifications as listed in the official Journal of the European Communities:

EN 61010-1:2001 Safety requirements for electrical equipment for measurement, control, and laboratory use



### DIRECTIVE 2002/95/EC (RoHS)

This instrument is exempt from Directive 2002/95/EC of the European Parliament and of the Council of 27 January 2003 on the Restriction of the use of certain Hazardous Substances (RoHS) in electrical and electronic equipment. Specifically, Avtech instruments are considered "Monitoring and control instruments" (Category 9) as defined in Annex 1A of Directive 2002/96/EC. The Directive 2002/95/EC only applies to Directive 2002/96/EC categories 1-7 and 10, as stated in the "Article 2 - Scope" section of Directive 2002/95/EC.

### DIRECTIVE 2002/96/EC (WEEE)

European customers who have purchased this equipment directly from Avtech will have completed a "WEEE Responsibility Agreement" form, accepting responsibility for WEEE

compliance (as mandated in Directive 2002/96/EC of the European Union and local laws) on behalf of the customer, as provided for under Article 9 of Directive 2002/96/EC.

Customers who have purchased Avtech equipment through local representatives should consult with the representative to determine who has responsibility for WEEE compliance. Normally, such responsibilities will lie with the representative, unless other arrangements (under Article 9) have been made.

Requirements for WEEE compliance may include registration of products with local governments, reporting of recycling activities to local governments, and financing of recycling activities.

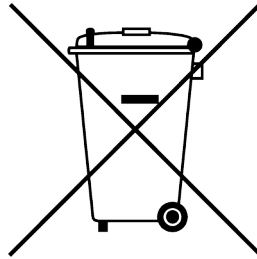

## BASIC AMPLITUDE CONTROL

The AVX-TRR-BTA is intended for use with an Avtech AVR-EB4-B reverse recovery test system, ordered separately. Please refer to the manual supplied with the AVR-EB4-B instrument for detailed usage instructions.

An example configuration suitable for use with the AVR-EB4-B is shown in the figure below. The PULSE output on the instrument mainframe is connected to the PULSE input on the test jig using BNC-to-SMA coaxial cable, and the control cable is connected using the supplied DB-9 cable. (The cables are supplied with the AVR-EB4-B.)

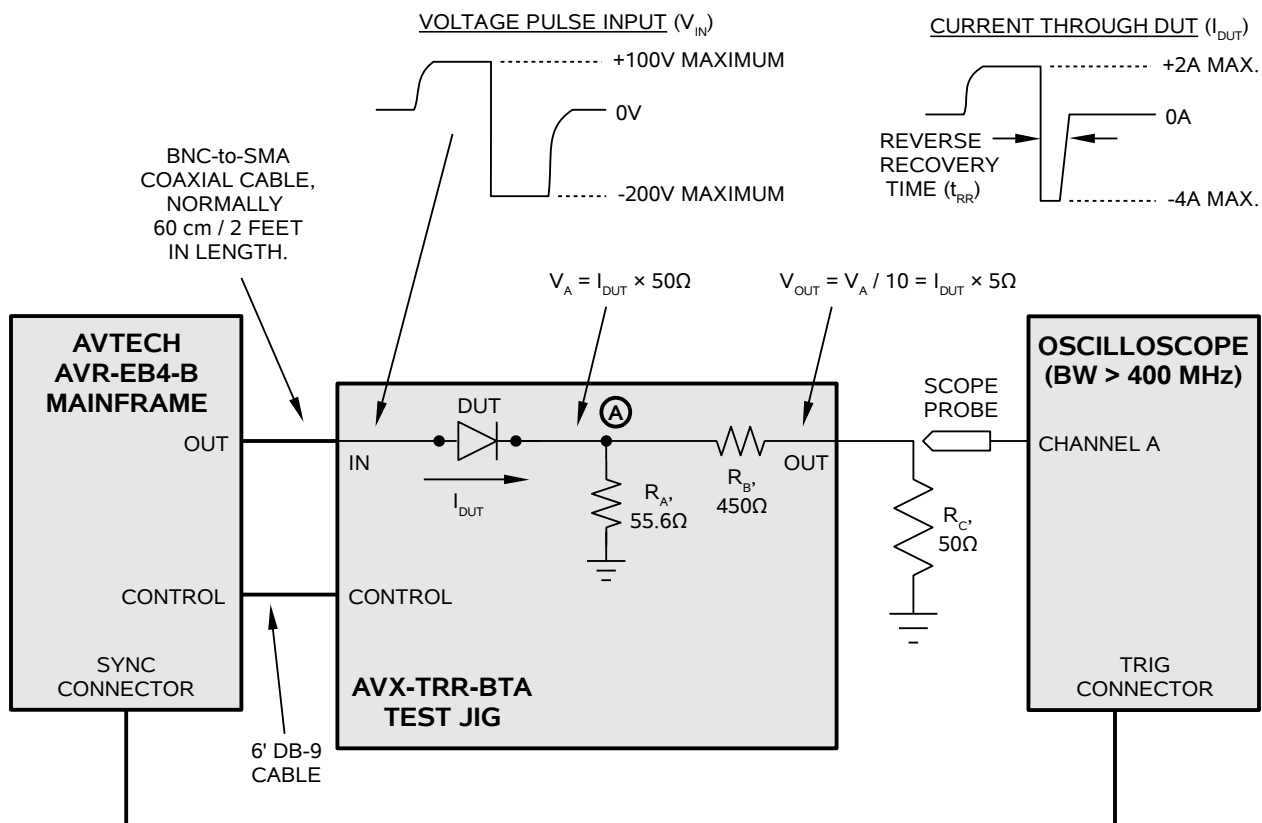

⚠ A 50 Ohm resistance ( $R_C$  in the diagram above) must be connected to ground on the output. This can be a discrete resistor, a feed-through terminator, or the input impedance of an oscilloscope. If a high-speed sampling oscilloscope is used, the input should be protected by adding attenuator on the input.

The total effective resistance of resistors  $R_A$ ,  $R_B$ , and  $R_C$  in the diagram above is 50 Ohms. Thus, the voltage at point "A" is simply given by:

$$V_A = I_{DUT} \times 50\Omega$$

where  $I_{DUT}$  is the current through the device under test. A 450 Ohm resistance ( $R_B$ ) is present in series with the measurement output. When a 50 Ohm resistance ( $R_C$ ) is installed on the output (by the user), the output voltage will be one-tenth of  $V_A$  due to the resistor-divider effect. That is:

$$V_{OUT} = V_A / 10 = I_{DUT} \times 5\Omega$$

This is the key equation for relating the observed voltage waveform to the DUT current.

### SETTING THE AMPLITUDE LEVELS

The amplitude of the positive and negative portions of the PULSE waveform may be set from the front panel of the AVR-EB4-B instrument, or by computer command. These settings are expressed in terms of the voltage present on the test jig input.

The positive voltage ("AMP1" on the front panel display) is related to the forward diode current by:

$$I_{FORWARD} \approx (AMP1 - V_F) / (50\Omega + R_{DIODE-FORWARD})$$

where  $V_F$  is the forward voltage drop of the diode (typically 0.7V for the classic silicon PN junction diode, and usually somewhat lower for a Schottky diode), and  $R_{DIODE-FORWARD}$  is the effective resistance of the diode under forward bias.

The negative voltage ("AMP2" on the front panel display) is related to the reverse diode current by:

$$I_{REVERSE} \approx AMP2 / (50\Omega + R_{DIODE-REVERSE}).$$

Where  $R_{DIODE-REVERSE}$  is the effective resistance of the diode under reverse bias.

It is important to note that  $R_{DIODE-FORWARD}$  and  $R_{DIODE-REVERSE}$  are not the same, and that they may change during the transient. Furthermore, depending on the design of the diode under test, it is possible that  $R_{DIODE-REVERSE}$  may be so high that it is impossible to achieve the full 4 Amps of reverse current. (The ideal diode would of course have  $R_{DIODE-REVERSE} = \infty$ ). The reverse voltage can actually be increased to -240V (rather than the nominal maximum of -200V) to increase the likelihood of obtaining the full 4 Amps of reverse current.

Most test procedures for measuring recovery time will use a particular ratio of forward to reverse currents - for example,  $I_{REVERSE} / I_{FORWARD} = 2$ .

Some Schottky diodes have negligible amounts of stored charge resulting from the forward bias, compared to non-Schottky devices. For these Schottky diodes, the



reverse transient will be governed by the capacitance of the device, and the reverse transient may be largely unaffected by the amplitude of the forward transient. (In other words, the  $I_{\text{REVERSE}} / I_{\text{FORWARD}}$  ratio is irrelevant). The capacitance may be so small that it becomes impossible to obtain the full -4 Amps of reverse current.

Normally, the forward and reverse amplitudes should be set near the maximum values (+100V, -200V). Performance may degrade if the amplitudes are set lower than 10% of the maximum values.

### AMPLITUDE ACCURACY

Due to the variations in  $V_F$  and  $R_{\text{DIODE-FORWARD}}$  and  $R_{\text{DIODE-REVERSE}}$  as a function of operating conditions, the AMP1 and AMP2 settings *should not be relied upon for any degree of accuracy*. Instead the voltage at the OUT terminal on the test jig should be monitored with a calibrated oscilloscope. As mentioned above,  $I_{\text{DUT}} = V / 5\Omega$ .

$R_A$  and  $R_B$  can be measured directly on the test jig (with the test jig disconnected) to determine calibrated relationships, if desired.  $R_C$  is provided by the user, and can be calibrated as required.

### INCORRECT ORIENTATION

The instrument and the DUT will not be damaged if the diode is installed with the incorrect orientation (i.e., with the anode and cathode reversed). However, incorrect waveforms will be generated,

### ACCESSIBLE VOLTAGES

The AVR-EB4-B mainframe provides pulsed voltages of up to 240V to the test jig. For this reason, the output is automatically disabled when the test jig lid is open. The lid must be closed to obtain measurements.

 Shielded cabling should be used for all connections to the "IN" and "OUT" terminals on the test jig, and the "OUT" connector on the mainframe.

 When used properly (with  $R_C = 50$  Ohms), the maximum voltage on the OUT terminal will be 24V, approximately. However, if  $R_C$  is not connected, the maximum voltage will at the OUT terminal may be as high as 240V. Avoid feeding this output directly into an oscilloscope. Always use a probe or an attenuator!

## TEST JIG MECHANICAL ASPECTS

The AVX-TRR-BTA test jig is designed to accept the unusual package shown below:

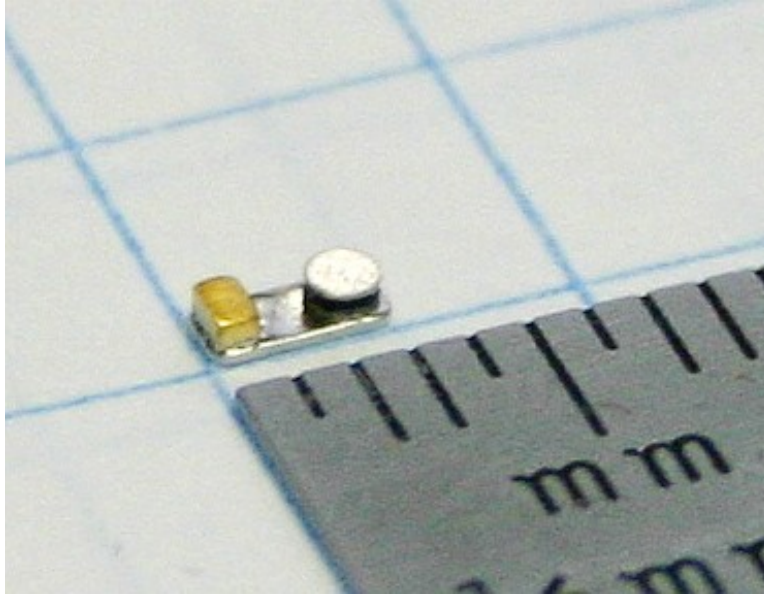

The AVX-TRR-BTA test jig is shown below:



The DUT is installed by pulling back on the chrome knob, as shown below:



The DUT is then placed on its side in the area immediately in front of the two fixed probe points, as shown in the photo above. Then slowly release the chrome knob, allowing the spring-loaded PCB to push the DUT into position against the two probe points, as shown below. The PCB silk-screening shows the proper device positioning.

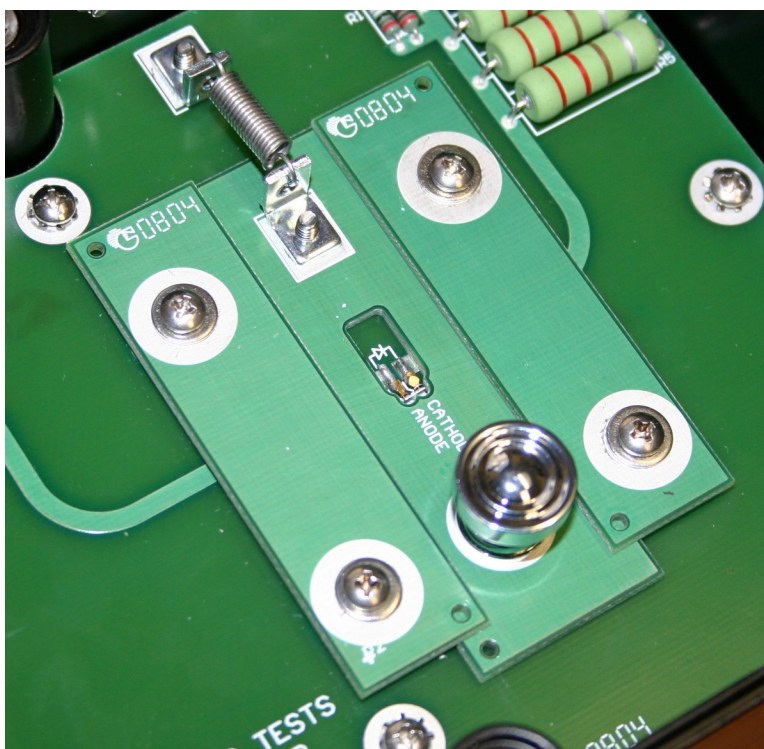

The anode pad must contact the left probe point, and the cathode pin must contact the right probe point.

The instrument and the DUT will not be damaged if the diode is installed with the incorrect orientation (i.e., with the anode and cathode reversed). However, incorrect waveforms will be generated.

The IN, OUT, and CONTROL connectors are on the rear of the jig, below the hinges:



## SAFETY INTERLOCK

The AVX-TRR-BTA contains safety interlock devices, for use with the AVR-EB4-B mainframe. The DB-9 female "CONTROL" connector should be connected to the corresponding connector on the AVR-EB4-B mainframe using the straight-through DB-9 cable supplied with the AVR-EB4-B.

The DB9 "CONTROL" connector pinout is as follows:

Pin 1 - To test jig switch 1.

Pin 2 - To test jig switch 2.

Pin 5 - Ground.

Pin 6 - To test jig switch 1.

Pin 7 - To test jig switch 2.

Pin 9 - Safety sensor power supply (+15V through 680 Ohms).

When the test jig lid is safely closed, Pin 1 is shorted to Pin 6, and Pin 2 is shorted to Pin 7. Switch 1 is a passive mechanical switch. Switch 2 is an active photosensor, which requires power from Pin 9.

## TYPICAL RESULTS

Obtaining meaningful results with the AVR-EB4-B requires care, experience, and an understanding of diode transient behavior and the impact of inductive and capacitive parasitics. To assist the user, typical results are provided below. The user should be able to reliably duplicate these results.

With a user-supplied device (part number unknown) installed in the AVX-TRR-BTA, and with the amplitudes set to generate  $I_F = +2A$  and  $I_R = -4A$ , the following results were obtained:

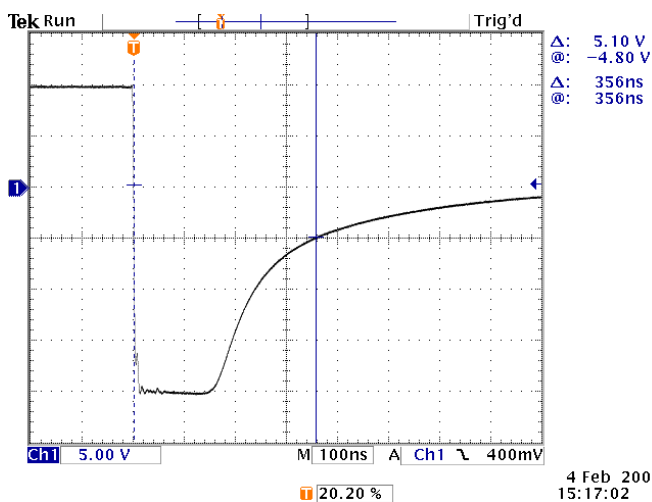

5 V/div (= 1 A/div), 100 ns/div.  
 $t_{RR}$  (at 25% of  $I_R$ ) = 356 ns.  
 S/N 11910. 60 cm cable used.

# WIRING DIAGRAM

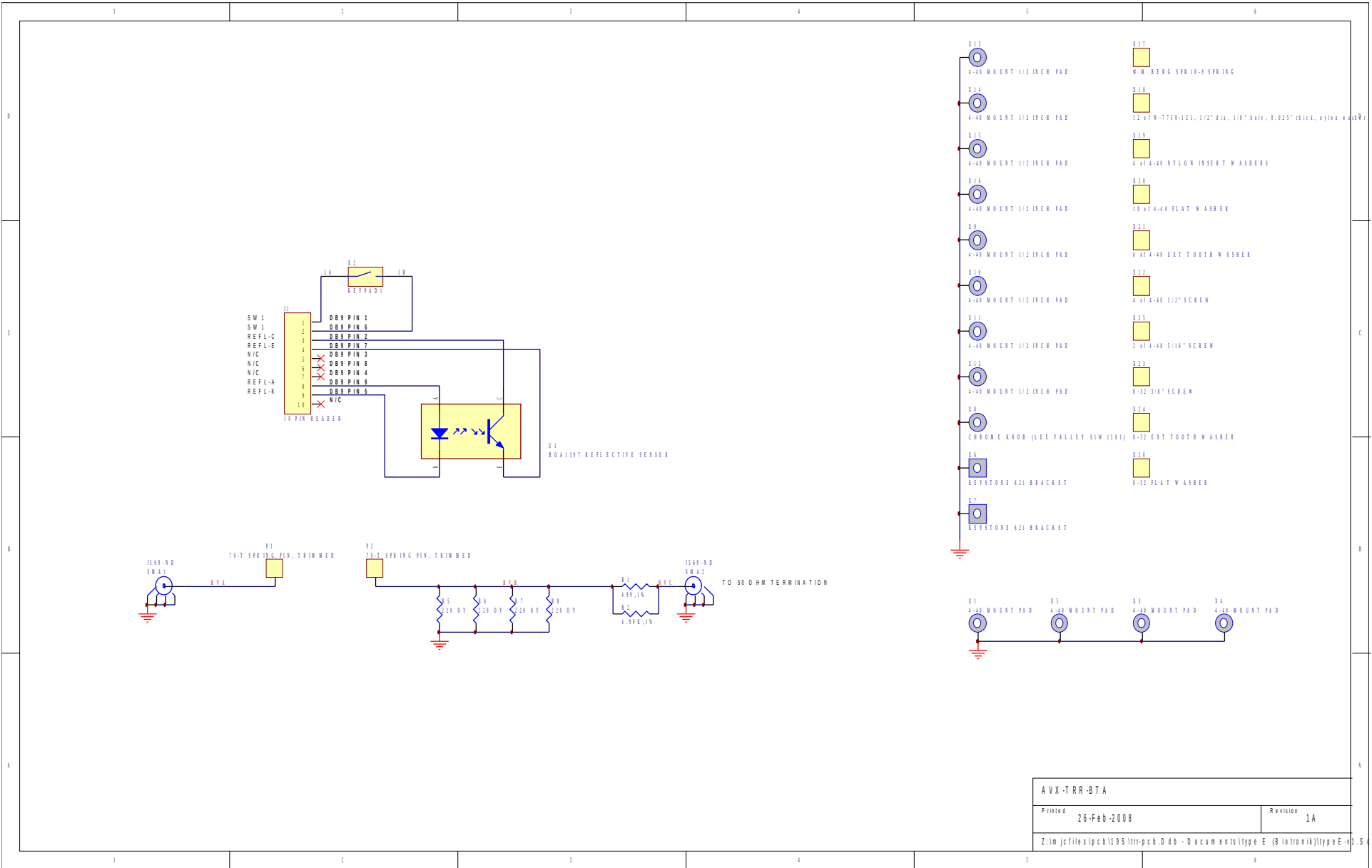

<b>AVX-TRR-BTA</b>	
Printed	Revision
26-Feb-2008	1A
Z:\m\jc\files\ipc\b1195\trr-pcb.Ddb - Documents\type.E (Biotronik)\type.E-.S	