

AVTECH ELECTROSYSTEMS LTD.

**NANOSECOND WAVEFORM ELECTRONICS
ENGINEERING . MANUFACTURING**

**P.O. BOX 265
OGDENSBURG
□ NEW YORK
13669
(315) 472-5270**

**BOX 5120 STN. 'F'
OTTAWA, ONTARIO
CANADA K2C 3H4
X (613) 226-5772
TELEX 053.4591**

INSTRUCTIONS

MODEL AV-107C-C-PN-N2 PULSE GENERATOR

S.N. :

WARRANTY

Avtech Electrosystems Ltd. warrants products of its manufacture to be free from defects in material and workmanship under conditions of normal use. If, within one year after delivery to the original owner, and after prepaid return by the original owner, this Avtech product is found to be defective, Avtech shall at its option repair or replace said defective item. This warranty does not apply to units which have been disassembled, modified or subjected to conditions exceeding the applicable specifications or ratings. This warranty is the extent of the obligation or liability assumed by Avtech with respect to this product and no other warranty or guarantee is either expressed or implied.

Fig. 1

PULSE GENERATOR TEST ARRANGEMENT

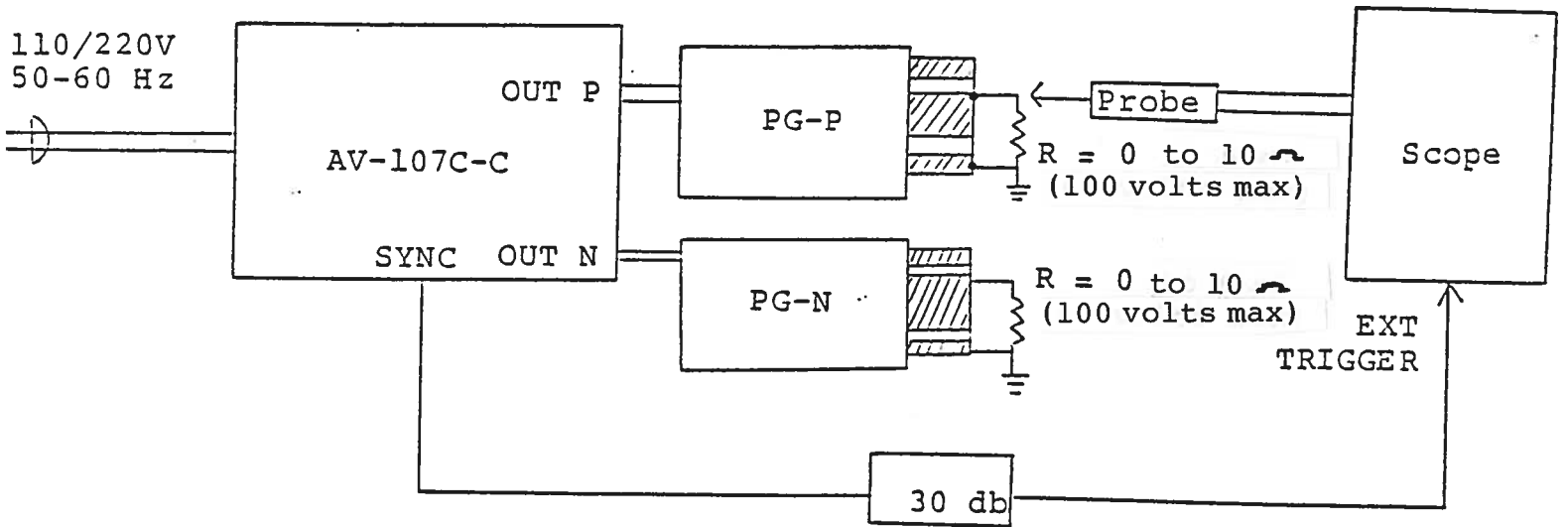

GENERAL OPERATING INSTRUCTIONS

- 1) The equipment should be connected in the general fashion shown above. Since the unit provides an output pulse rise time as low as 10 nsec a fast oscilloscope (at least 50 MHz and preferably 200 MHz) should be used to display the waveform. Alternatively, the output current may be monitored using a current probe such as the TEKTRONIX Model CT-2.
- 2) The sync output channel provides TTL level signals. To avoid overdriving the TRIG input channel of some sampling scopes, a 30 db attenuator should be placed at the input to the sampling scope trigger channel.
- 3) The desired output polarity is selected by means of the front panel POLARITY switch. With the POLARITY switch in the P position, the negative output pulse generator is rendered inactive. Likewise, with the POLARITY switch in the N position, the positive pulse generator is rendered inactive.
- 4) To obtain a stable output display the PRF control on the front panel should be set mid-range. The front panel TRIG toggle switch should be in the INT position. The front panel DELAY control and the scope triggering controls are then adjusted to obtain a stable output. The scope may then be used to set the desired PRF by rotating the PRF control and by the PRF RANGE switch. The main output is delayed with respect to the SYNC output by about 0 to 1 usec depending on the DELAY control setting.
- 5) The output terminals of the pulse generator module consists of a short length of microstrip transmission line protruding from the module chassis. The OUT terminal is the center conductor which is bounded on both sides by the ground plane (see below):

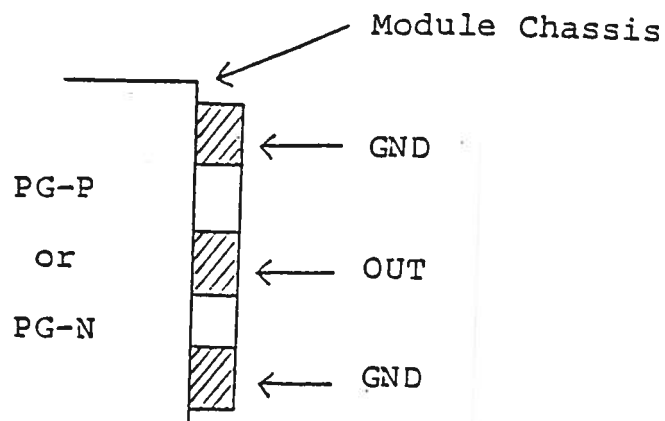

The load should be connected between the OUT and GND terminals using very short leads (≤ 0.5 cm). (See 11).

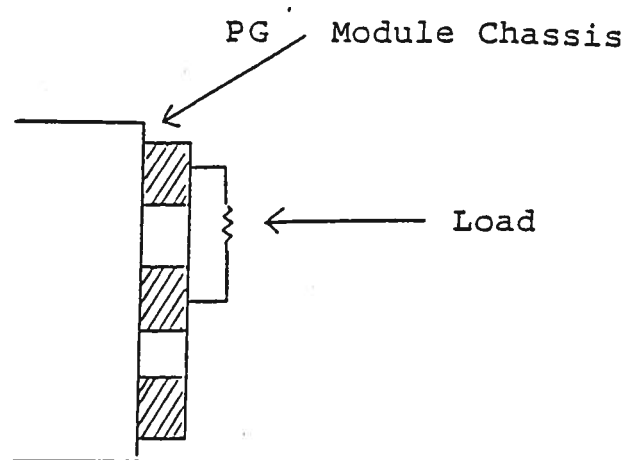

Take care to insure that during soldering the OUT conductor is not shorted to the chassis. Also, use minimal heat when soldering.

- 6) M Option. The SMA output port (M) on the PG-P and PG-N modules provides a replica of the output pulse (when connected to a fifty ohm load). The output pulse load current (Amps) and the M output voltage (Volts) are related as follows:

$$I_{LOAD} = 20 V_M$$

- 7) CAUTION: The AV-107C-C unit is designed to provide 0 to 10 ampere pulses to a load voltage in the range of 0 to 100 volts. Insure that the load can dissipate up to 0.75 KW peak power and up to 10 watts average power (at maximum amplitude and duty cycle).
- 8) The output pulse widths for the positive and negative outputs are controlled by means of the front panel PW controls (P and N).
- 9) The output pulse amplitudes for the positive and negative outputs are controlled by means of the front panel AMP P and AMP N controls. The pulse generator will supply up to 10 amperes to a load voltage as high as 100 volts.
- 10) To voltage control the output pulse width, remove the jumper wire between banana plugs A and B on the back panel and apply 0 to +10V to connector B ($R_{IN} \geq 10K$). (option).

- 11) To voltage control the output amplitude, remove the jumper wire between banana plugs A and B on the back panel and apply 0 to +10V to connector B ($R_{IN} > 10K$). (option).
- 12) An external clock may be used to control the output PRF of the unit by setting the front panel TRIG toggle switch in the EXT position and applying a 0.2 usec (approx.) TTL level pulse to the TRIG BNC connector input. For operation in this mode, the scope time base must also be triggered by the external clock rather than from the SYNC output.
- 13) The AV-107 is specifically designed for driving resistive loads and laser diode loads with series resistance. The loads should be connected directly to the microstrip line protruding from the PG module with very short leads. An example of the waveform for a 3 ohm resistive load is shown in A. The overshoot and ringing on the rising edge is due to the series inductance and high time rate of change of current. LENZ'S LAW $-(L \frac{di}{dt})$ predicts a voltage spike of 10 volts for a series inductance of 10 nh and a 10 ampere change of I in 10 nsec. The importance of short leads is therefore critical. B illustrates the output of a 7" 50 ohm cable is placed between the PG module and the leads. Note degradation of switching time. If a highly nonlinear load such as a zener diode or IMPATT diode is connected to the PG output, oscillation such as shown in C may be observed. The oscillation can be controlled by introducing some series resistance as shown in D (1 to 3 ohm). In addition, shunt capacitance (500 to 2000 pfd) placed across the diode and/or across the PG output will serve to reduce oscillation.
- 14) CAUTION: The output stage is protected against overload condition by a 0.1 A slow blow fuse on the main frame back panel. However, the output switching elements (SL12T) may fail if the unit is triggered at a PRF exceeding 10 KHz. Heating and subsequent likely failure of the output stage is reduced if the following action is taken where possible:
 - a) PRF is kept to a minimum, ie. operate in the LOW PRF range when possible rather than in the HIGH range.
 - b) Keep the output PW to a minimum.
 - c) Keep the output voltage as near to 100 volts as possible by adding series resistance to diode type loads to increase the effective output voltage.
- 15) The unit can be converted from 110 to 220V 50-60 Hz operation by adjusting the voltage selector card in the rear panel fused voltage selector cable connector assembly.

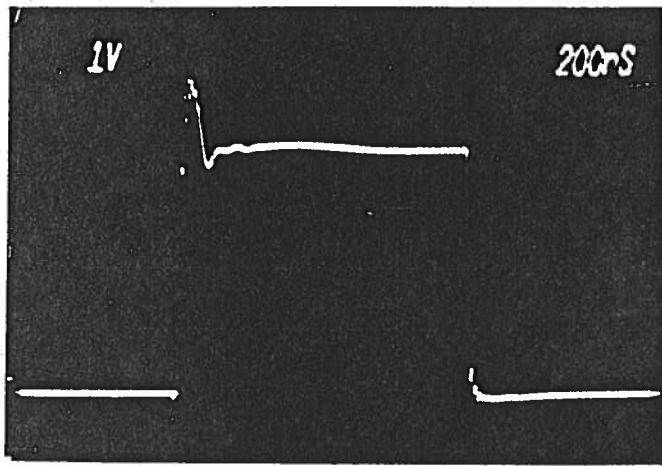

(A)

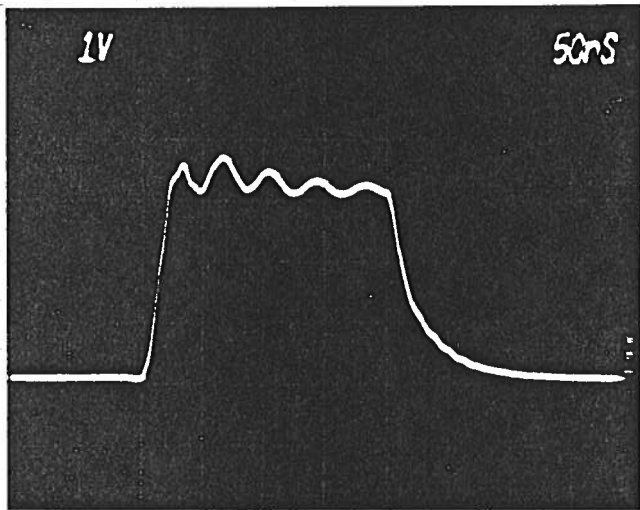
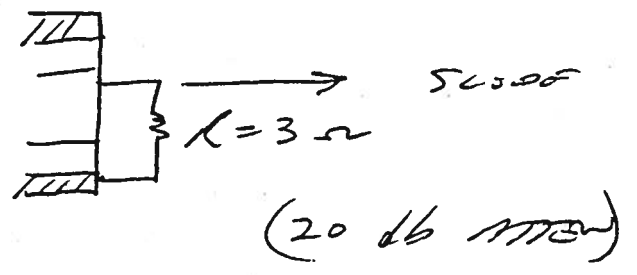

(B)

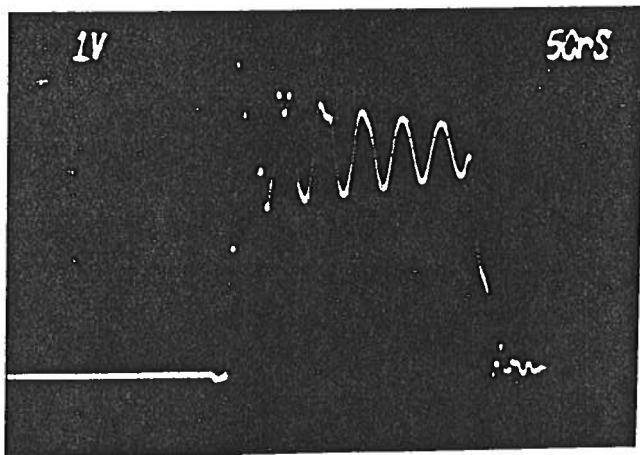
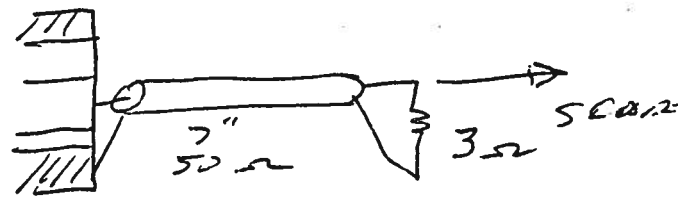

(C)

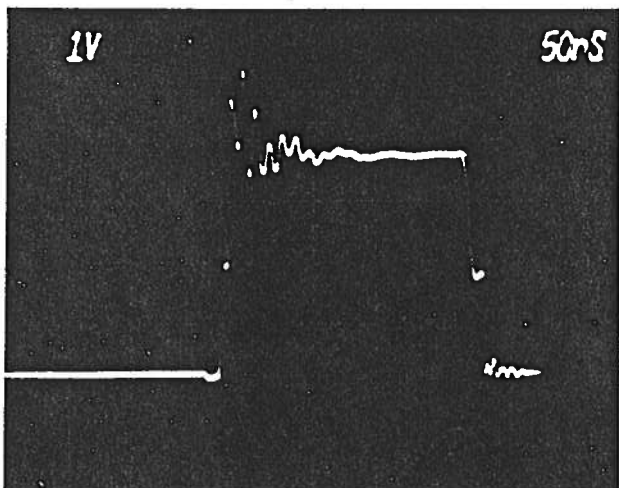
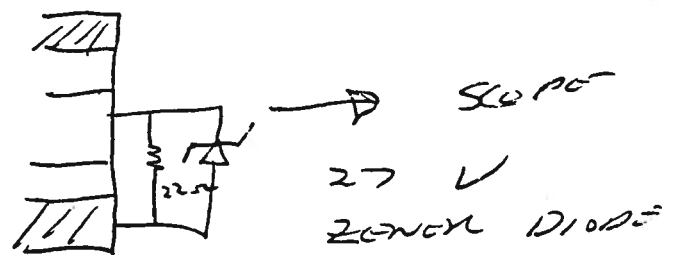

(D)

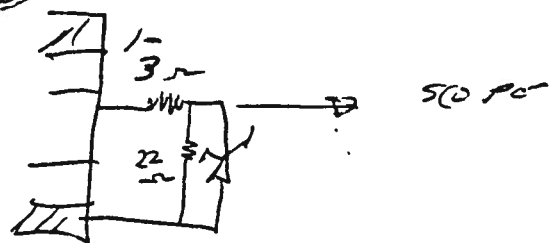
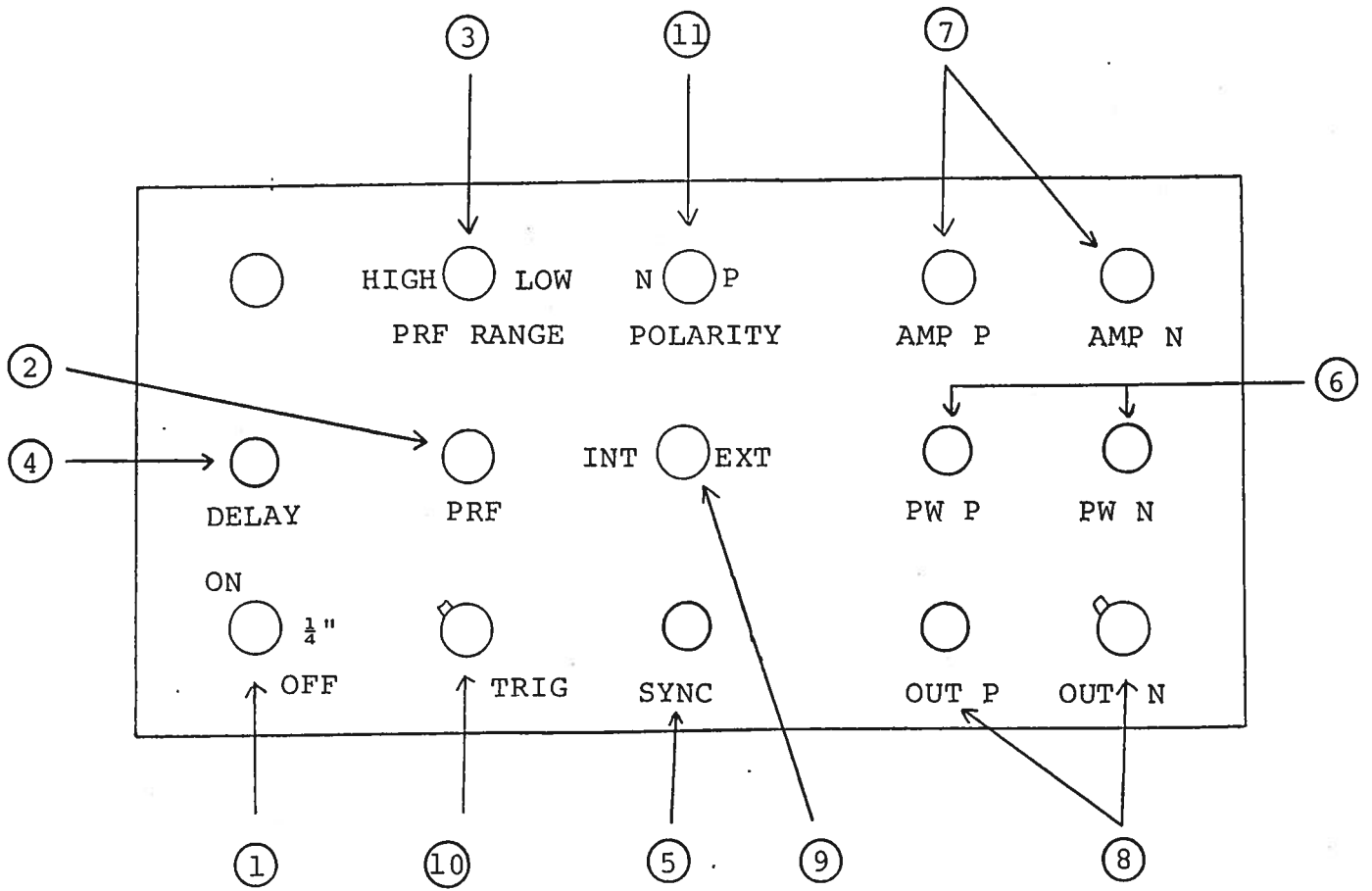

Fig. 2

FRONT PANEL CONTROLS



- (1) ON-OFF Switch. Applies basic prime power to all stages.
- (2) PRF Control. Varies PRF from about 10 Hz to about 1000
- (3) Hz (RANGE L) and 100 Hz to 10 KHz (RANGE H). The PRF should be set using an oscilloscope.
- (4) DELAY Control. Controls the relative delay between the reference output pulse provided at the SYNC output (5) and the main outputs. This delay is variable over the range of about 0 to about 1 usec.
- (5) SYNC Output. This output precedes the main output and is used to trigger the scope time base. The output is a TTL level 100 nsec (approx.) pulse capable of driving a fifty ohm load.
- (6) PW Control (P and N). One turn controls which varies the output pulse width from 50 nsec to 1.0 usec.
- (7) AMP Control (P and N). The output pulse amplitude is controlled by means of the one turn potentiometers.
- (8) OUT Connector. A multi pin connector which attaches the 2 foot cable from the pulse generator modules (AV-107C-M-N2-PG-P and AV-107C-M-N2-PG-N) to the main frame. CAUTION: Take care to insure that PG-P is connected to the P OUT connector and PG-N is connected to the N OUT connector.
- (9) EXT-INT Control. With this toggle switch in the INT position, the PRF of the unit is controlled via an internal clock which in turn is controlled by the PRF controls. With the toggle switch in the EXT position, the unit requires a 0.2 usec TTL level pulse applied at the TRIG input in order to trigger the output stages. In addition, in this mode, the scope time base must be triggered by the external trigger source.
- (10) TRIG Input. The external trigger signal is applied at this input when the EXT toggle switch is in the EXT position. The output pulse appears about 60 nsec after the application of the TRIG pulse.
- (11) POLARITY. The desired output polarity is selected by means of the POLARITY switch. With the POLARITY switch in the P position, the negative output pulse generator is rendered inactive. Likewise, with the POLARITY switch in the N position, the positive pulse generator is rendered inactive.

Fig. 3

BACK PANEL CONTROLS

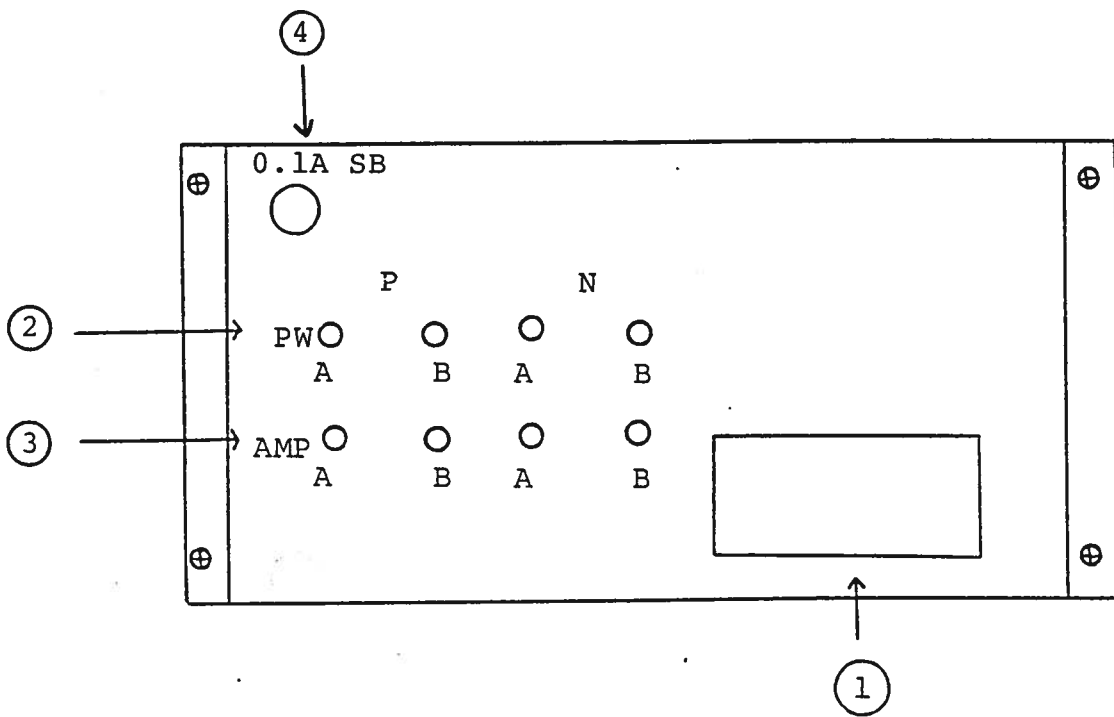

- (1) FUSED CONNECTOR, VOLTAGE SELECTOR. The detachable power cord is connected at this point. In addition, the removable cord is adjusted to select the desired input operating voltage. The unit also contains the main power fuse.
- (2) To voltage control the output pulse width, remove the jumper wire between banana plugs A and B on the back panel and apply 0 to +10V to connector B ($R_{IN} \geq 10K$). (option).
- (3) To voltage control the output amplitude, remove the jumper wire between banana plugs A and B on the back panel and apply 0 to +10V to connector B ($R_{IN} \geq 10K$). (option).
- (4) 0.1 A SB FUSE. Protects output stage against overload conditions.

ON-OFF

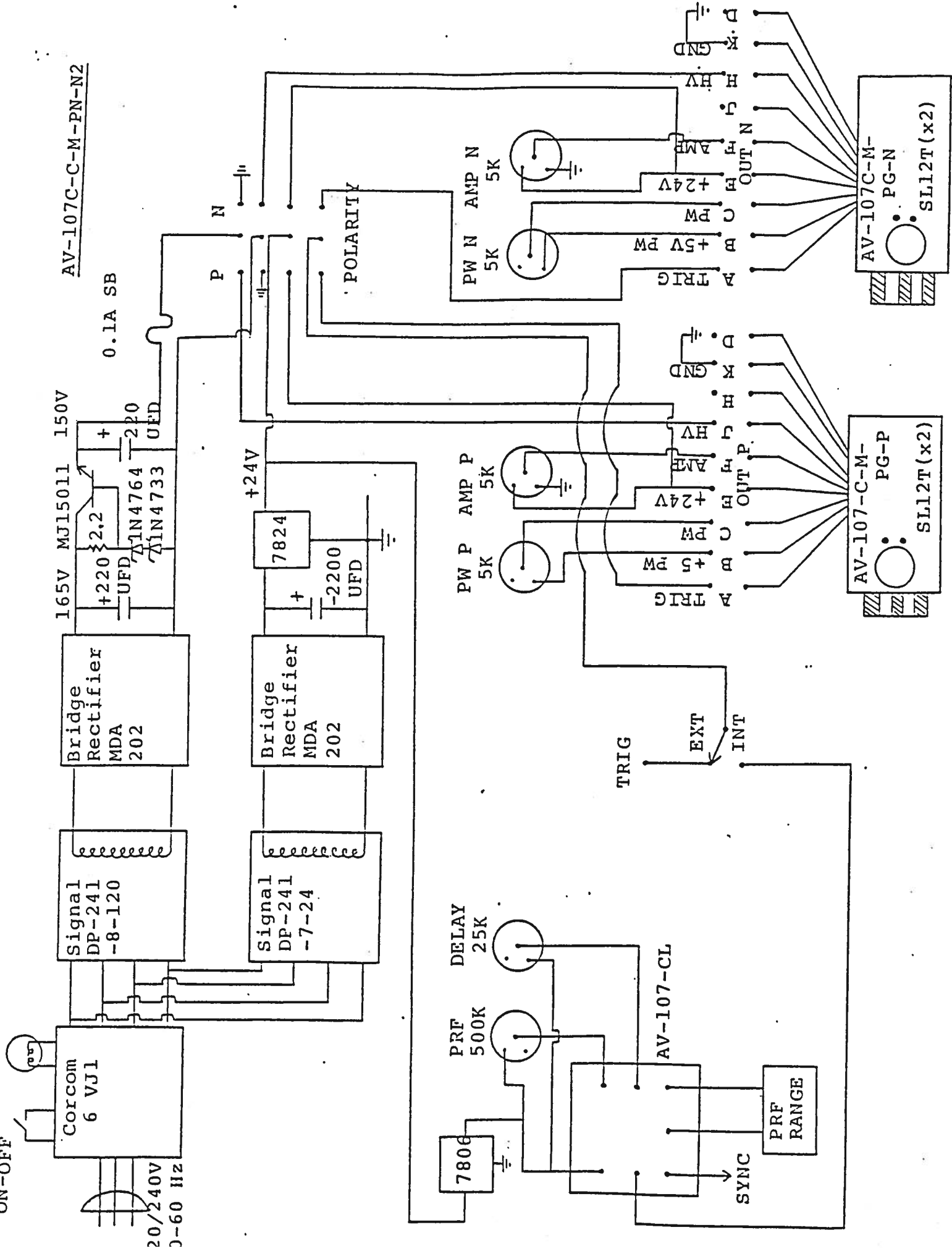

PC-107C

SL12T HEAT SINK

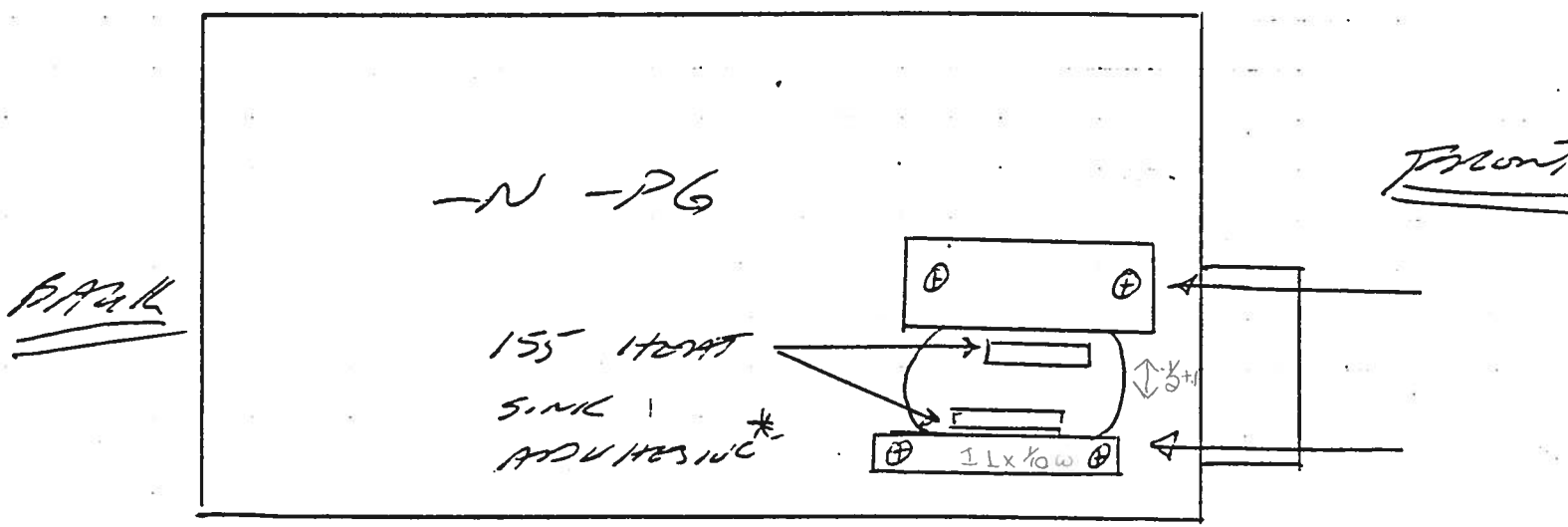
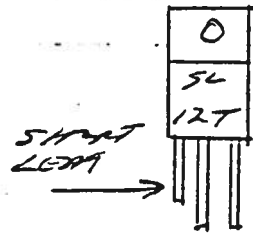
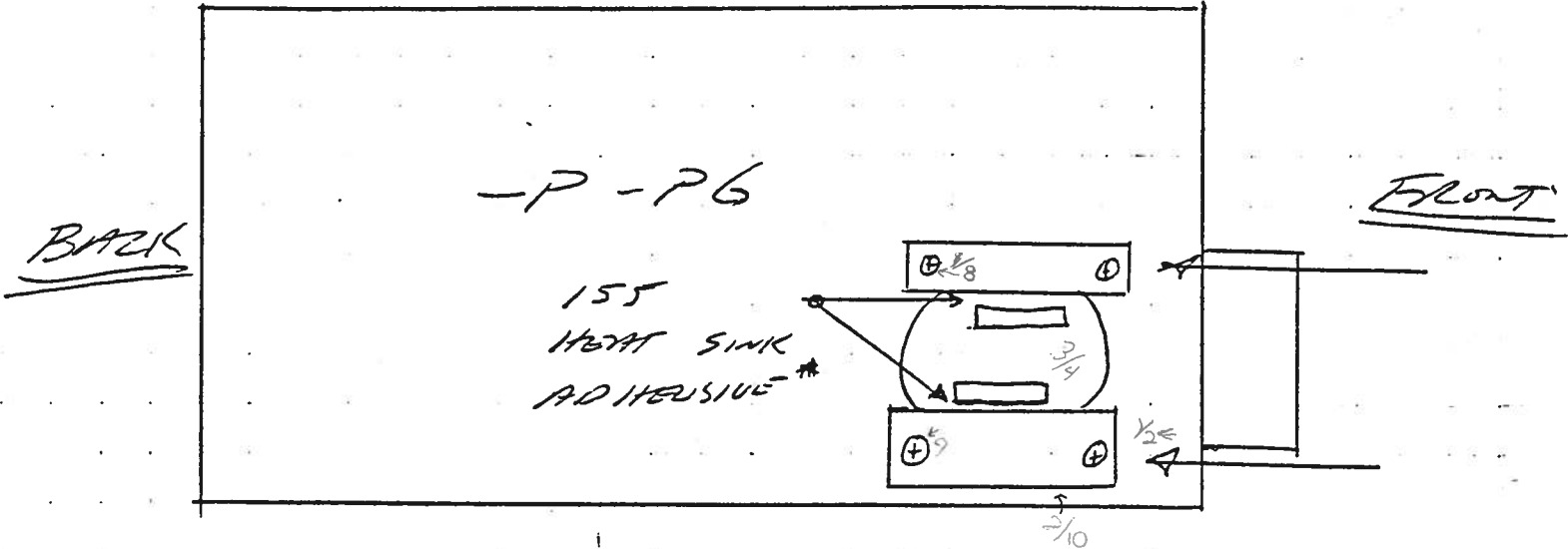

*
CAREFUL INSURE THAT
TABS OF SLIT
DO NOT CONTACT
ITS TABS.

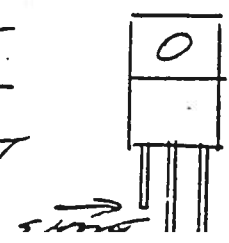

AV-107C SL12T HEAT SINKING

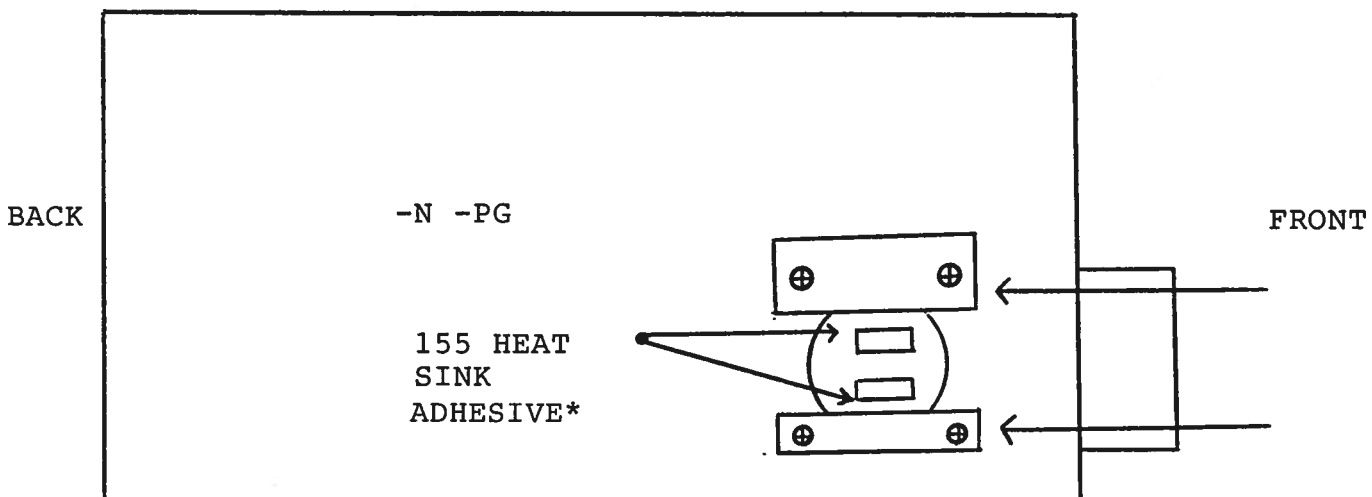
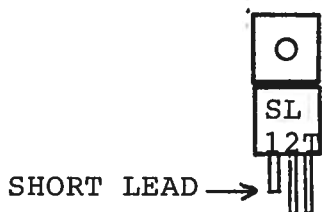
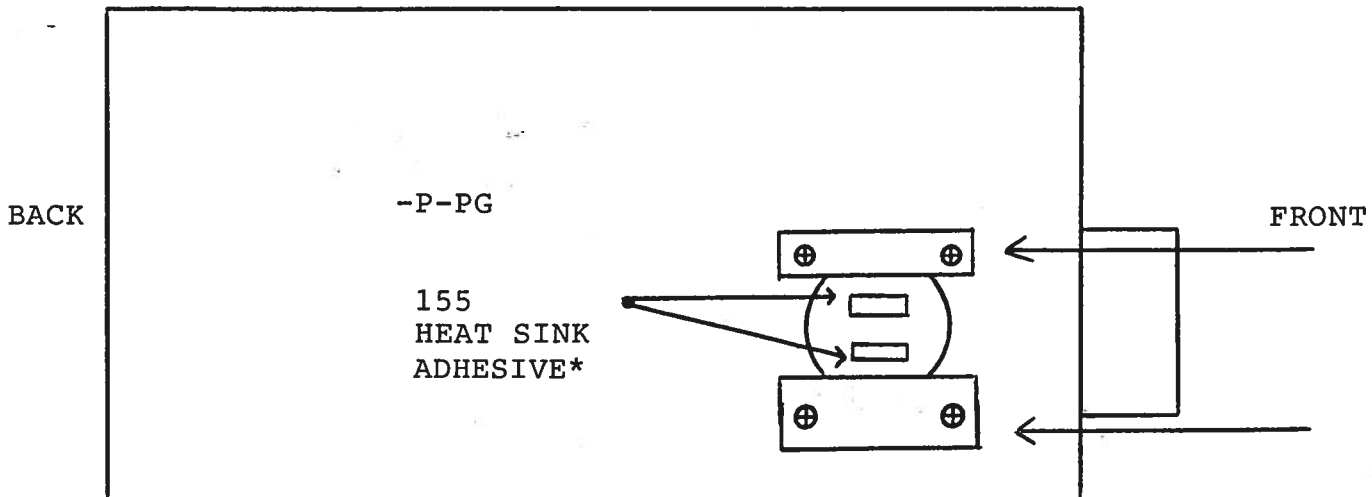

*CAUTION: INSURE THAT TABS OF SL12T DO NOT CONTACT H.S. BARS.

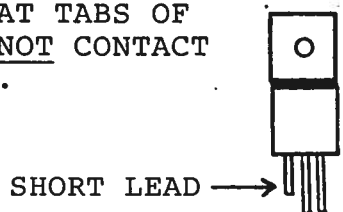

SYSTEM DESCRIPTION AND REPAIR PROCEDURE

The AV-107C-C-M-PN unit consists of the following basic modules:

- 1) AV-107C-M-PG pulse generator modules (positive and negative)
- 2) AV-107C-CL clock module
- 3) +24V power supply board
- 4) +100V power supply board

The modules are interconnected as shown in Fig. 4.

In the event of an instrument malfunction, it is most likely that the 0.10 A slow blow fuse or the main power fuse on the rear panel has blown. Replace if necessary. If the unit still does not function, it is most likely that some of the output switching elements (SL12T) may have failed due to an output short circuit condition or to a high duty cycle condition. The switching elements may be accessed by removing the cover plate on the bottom side of the -PG module. The cover plate is removed by removing the four counter sunk 6-32 Phillips screws. NOTE: First turn off the prime power. CAUTION: Briefly ground the SL12T tabs to discharge the 100 volts power supply potential. The elements may be removed from their sockets by means of a needle nosed pliers after removing the four counter sunk 2-56 Phillips screws which attach the small aluminum heat sinks to the body of the AV-107-PG module. The SL12T is a selected VMOS power transistor in a TO 220 package and may be checked on a curve tracer. If defective, replacement units should be ordered directly from Avtech. When replacing the SL12T switching elements, take care to insure that the short lead (of the three leads) is adjacent to the back of the chassis. (See following Fig.). The SL12T elements are electrically isolated from the small aluminum heat sinks but are bonded to the heat sinks using WAKEFIELD TYPE 155 HEAT SINK ADHESIVE. If the switching elements are not defective, then the four Phillips screws on the back panel should be removed. The top cover may then be slid off and the operation of the clock and power supply modules checked. The clock module is functioning properly if:

- a) 0.1 usec TTL level outputs are observed at pins 2 and 3.
- b) The PRF of the outputs can be varied over the range of 10 Hz to 10 KHz using the PRF controls.
- c) The relative delay between the pin 2 and 3 outputs can be varied by at least 1 usec by the DELAY control.

The sealed clock module must be returned to Avtech for repair or replacement if the above conditions are not observed.

Schroff

10.01.87

9

- M

- EW

- EA