

AVTECH ELECTROSYSTEMS LTD.

NANOSECOND WAVEFORM ELECTRONICS
ENGINEERING - MANUFACTURING

□ P.O. BOX 265
OGDENSBURG
NEW YORK
13669
(315) 472-5270

✕
□ BOX 5120, STN. "F"
OTTAWA, ONTARIO
CANADA K2C 3H4
TEL: (613) 226-5772
FAX: (613) 226-2802

INSTRUCTIONS

MODEL AV-107C-PS-ATT2 PULSE GENERATOR

S.N. :

WARRANTY

Avtech Electrosystems Ltd. warrants products of its manufacture to be free from defects in material and workmanship under conditions of normal use. If, within one year after delivery to the original owner, and after prepaid return by the original owner, this Avtech product is found to be defective, Avtech shall at its option repair or replace said defective item. This warranty does not apply to units which have been disassembled, modified or subjected to conditions exceeding the applicable specifications or ratings. This warranty is the extent of the obligation or liability assumed by Avtech with respect to this product and no other warranty or guarantee is either expressed or implied.

Fig. 1

PULSE GENERATOR TEST ARRANGEMENT

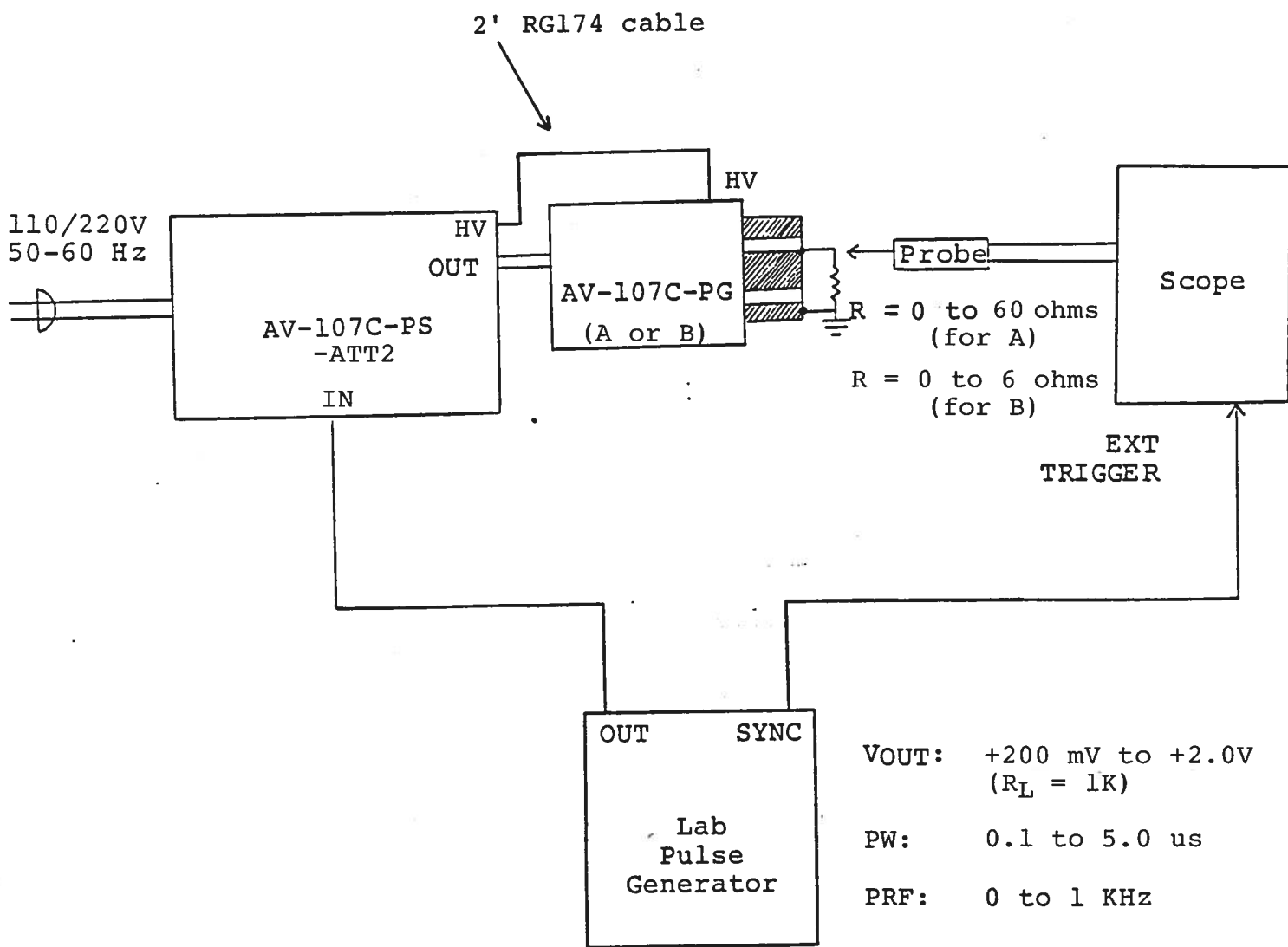

GENERAL OPERATING INSTRUCTIONS

- 1) The equipment should be connected in the general fashion shown above. Since the unit provides an output pulse rise time as low as 10 nsec a fast oscilloscope (at least 50 MHz and preferably 200 MHz) should be used to display the waveform. Alternatively, the output current may be monitored using a current probe such as the TEKTRONIX Model CT-2.
- 2) The output terminals of the pulse generator module consists of a short length of microstrip transmission line protruding from the module chassis. The OUT terminal is the center conductor which is bounded on both sides by the ground plane (see below):

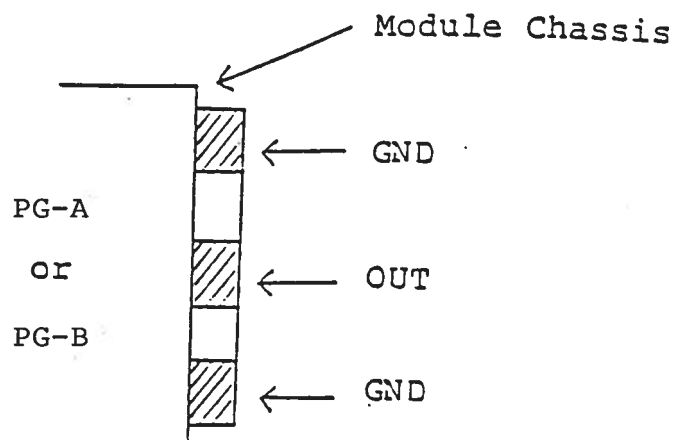

The load should be connected between the OUT and GND terminals using very short leads (\ll 0.5 cm). (See 11).

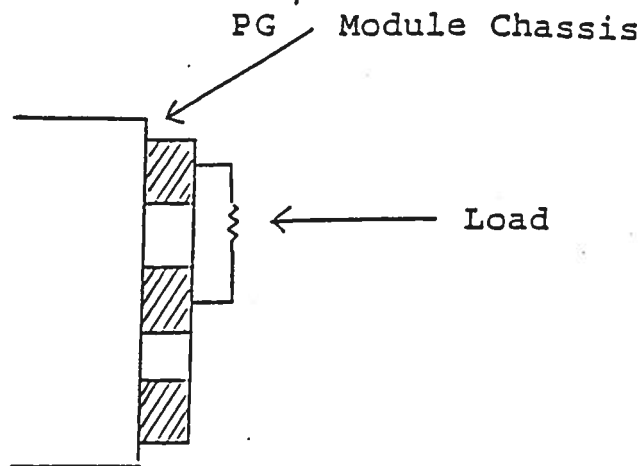

Take care to insure that during soldering the OUT conductor is not shorted to the chassis. Also, use minimal heat when soldering.

- 3) **CAUTION:** The AV-107C unit is designed to provide 0 to 10 ampere pulses to a load voltage in the range of 0 to 60 volts. Insure that the load can dissipate up to 0.75 KW peak power and up to 10 watts average power (at maximum amplitude and duty cycle).
- 4) The output pulse width is controlled by the input trigger pulse width (0.1 to 5.0 us).
- 5) The output pulse amplitude is controlled by the input trigger amplitude as follows:

V _{IN}	I _{OUT}	
	A	B
0.2V	100 mA	1.0 Amp
2.0V	1.0 Amp	10 Amp

Note that the amplitude control circuit has a time constant of tens of milliseconds and so pulse to pulse variation of the input amplitude will not be replicated at the output.

- 6) The AV-107 is specifically designed for driving resistive loads and laser diode loads with series resistance. The loads should be connected directly to the microstrip line protruding from the PG module with very short leads. An example of the waveform for a 3 ohm resistive load is shown in A. The overshoot and ringing on the rising edge is due to the series inductance and high time rate of change of current. LENZ'S LAW $-(L \frac{di}{dt})$ predicts a voltage spike of 10 volts

for a series inductance of 10 nH and a 10 ampere change of I in 10 nsec. The importance of short leads is therefore critical. B illustrates the output of a 7" 50 ohm cable is placed between the FG module and the leads. Note degradation of switching time. If a highly nonlinear load such as a zener diode or IMPATT diode is connected to the FG output, oscillation such as shown in C may be observed. The oscillation can be controlled by introducing some series resistance as shown in D (1 to 3 ohm). In addition, shunt capacitance (500 to 2000 pfd) placed across the diode and/or across the FG output will serve to reduce oscillation.

- 7) **CAUTION:** The output stage is protected against overload condition by a 1.0 A slow blow fuse on the main frame back panel. However, the output switching elements (SL12T) may fail if the unit is triggered at a PRF exceeding 1 KHz. Heating and subsequent likely failure of the output stage is reduced if the following action is taken where possible:
 - a) PRF is kept to a minimum, ie. operate in the LOW PRF range when possible rather than in the HIGH range.
 - b) Keep the output PW to a minimum.
 - c) Keep the output voltage as near to 50 volts as possible by adding series resistance to diode type loads to increase the effective output voltage.

- 8) AV-107 units with a serial number higher than 5600 are protected by an automatic overload protective circuit which controls the front panel overload light. If the unit is overloaded (by operating at an exceedingly high duty cycle or by operating into a short circuit), the protective circuit will turn the output of the instrument OFF and turn the indicator light ON. The light will stay ON (i.e. output OFF) for about 5 seconds after which the instrument will attempt to turn ON (i.e. light OFF) for about 1 second. If the overload condition persists, the instrument will turn OFF again (i.e. light ON) for another 5 seconds. If the overload condition has been removed, the instrument will turn on and resume normal operation. Overload conditions may be removed by:
 - 1) Reducing PRF (i.e. switch to a lower range)
 - 2) Reducing pulse width (i.e. switch to a lower range)

- 9) The unit can be converted from 110 to 220V 50-60 Hz operation by adjusting the voltage selector card in the rear panel fused voltage selector cable connector assembly.

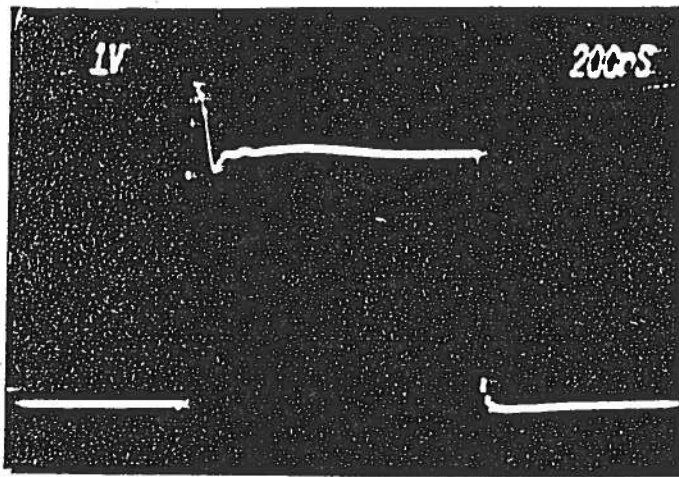

(A)

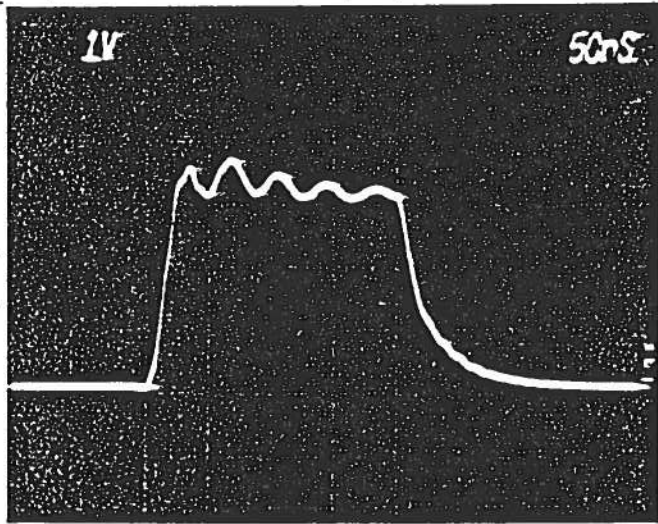
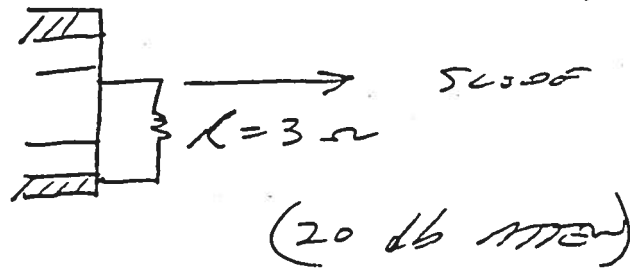

(B)

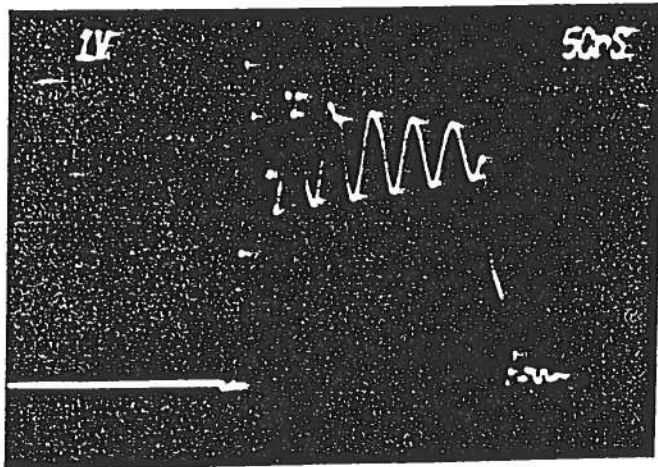
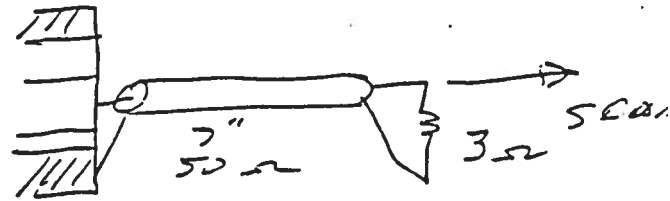

(C)

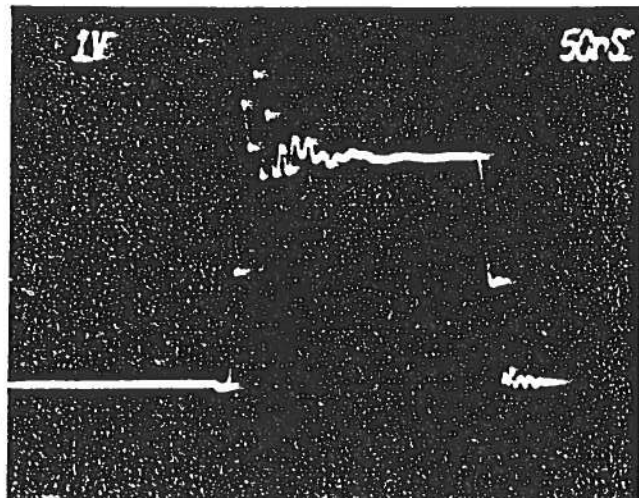
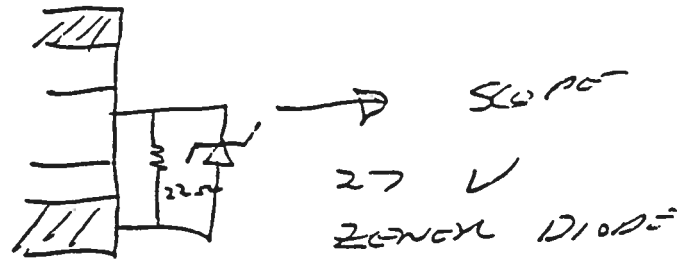

(D)

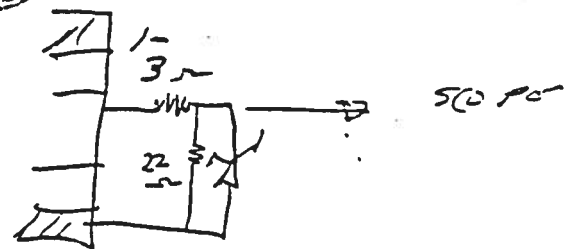
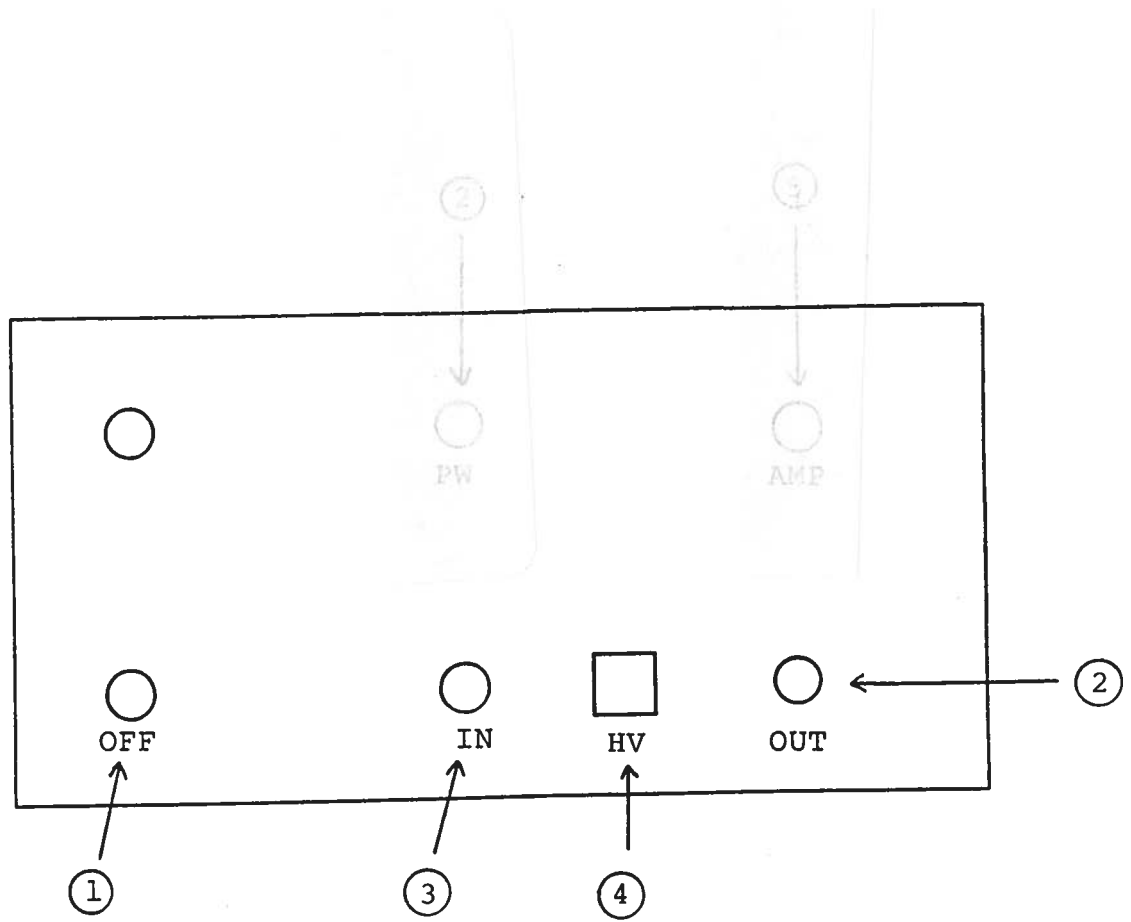

Fig. 2

FRONT PANEL CONTROLS



- (1) ON-OFF Switch. Applies basic prime power to all stages.
- (2) OUT Connector. A multi pin connector which attaches the 2 foot cable from the pulse generator module to the main frame.
- (3) IN. The external trigger signal is applied at this input.
- (4) HV OUT. A 2' long RG174 cable must connect the SMA connector to the PG module. CAUTION: The center conductor is at a potential of 120V DC.

Fig. 3

BACK PANEL CONTROLS

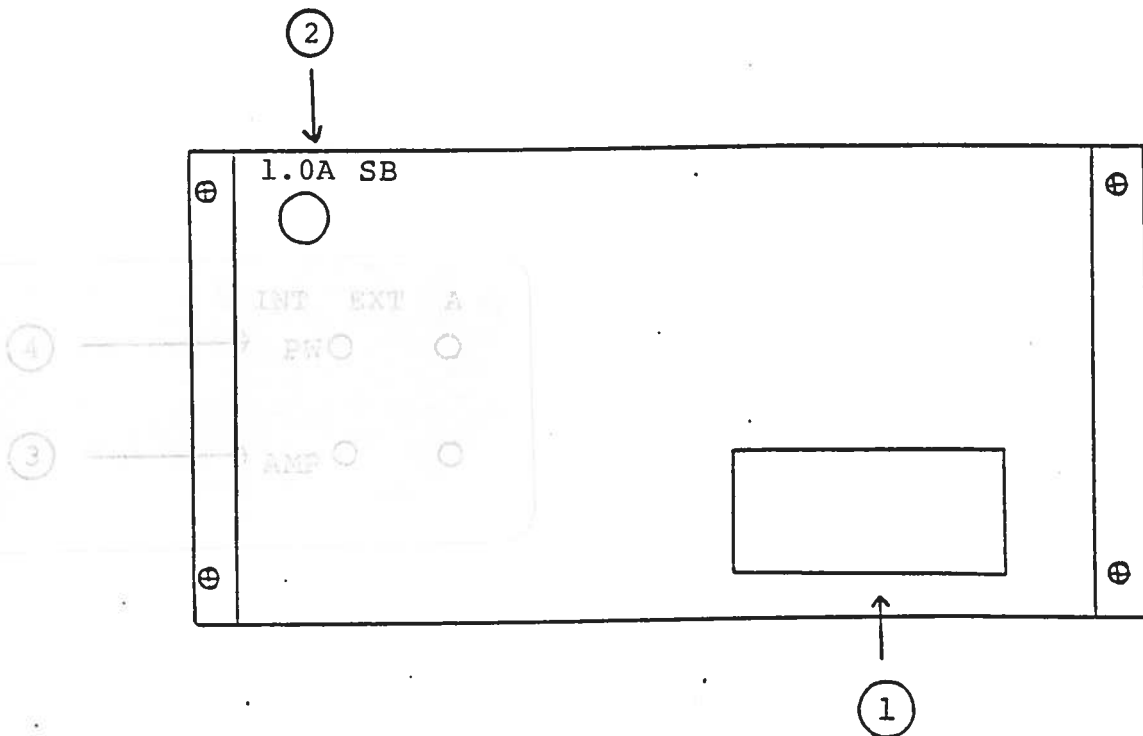

- (1) FUSED CONNECTOR, VOLTAGE SELECTOR. The detachable power cord is connected at this point. In addition, the removable cord is adjusted to select the desired input operating voltage. The unit also contains the main power fuse.
- (2) 1.0 A SB. Fuse which protects the output stage if the output duty cycle rating is exceeded.

SYSTEM DESCRIPTION AND REPAIR PROCEDURE

The AV-107C-FS unit consists of the following basic modules:

- 1) AV-107C-PG pulse generator module
- 2) +24V power supply board
- 3) ATT2-FS-EA power supply-amplitude module
- 4) ATT2-EW pulse width control module
- 5) ATT2-OL overload module

The modules are interconnected as shown in Fig. 4.

In the event of an instrument malfunction, it is most likely that the 1.0 A slow blow fuse or the main power fuse on the rear panel has blown. Replace if necessary. If the unit still does not function, it is most likely that some of the output switching elements SL12T (B unit) or SL5T (A unit) may have failed due to an output short circuit condition or to a high duty cycle condition. The switching elements may be accessed by removing the cover plate on the bottom side of the -PG module. The cover plate is removed by removing the four counter sunk 6-32 Phillips screws. NOTE: First turn off the prime power. CAUTION: Briefly ground the SL12T (or SL5T) tabs to discharge the 100 volts power supply potential. The elements may be removed from their sockets by means of a needle nosed pliers after removing the four counter sunk 2-56 Phillips screws which attach the small aluminum heat sinks to the body of the AV-107-PG module. The SL12T is a selected VMOS power transistor in a TO 220 package and may be checked on a curve tracer. If defective, replacement units should be ordered directly from Avtech. When replacing the SL12T switching elements, take care to insure that the short lead (of the three leads) is adjacent to the back of the chassis. (See following Fig.). The SL12T elements are electrically isolated from the small aluminum heat sinks but are bonded to the heat sinks using WAKEFIELD TYPE 155 HEAT SINK ADHESIVE.

AV-107C SL12T HEAT SINKING

BACK

FRONT

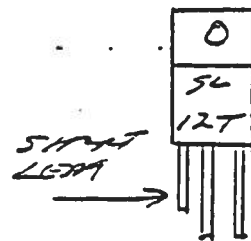
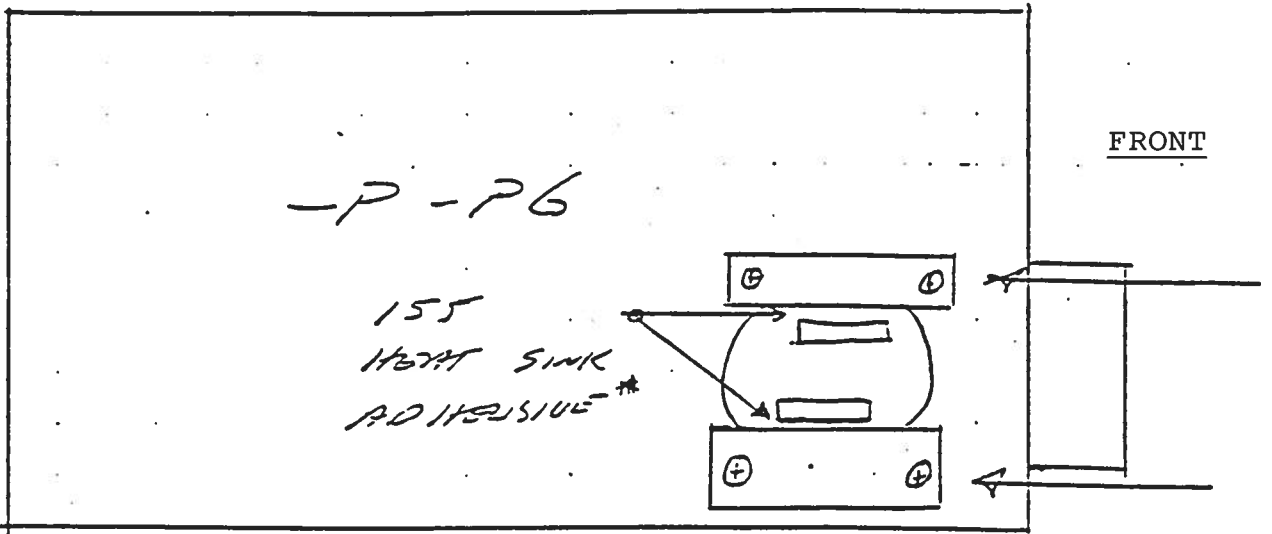

Schroff

11.08.91