

**AVTECH ELECTROSYSTEMS LTD.**

**NANOSECOND WAVEFORM ELECTRONICS  
ENGINEERING . MANUFACTURING**

□ P.O. BOX 265  
OGDENSBURG  
NEW YORK  
13669  
(315) 472-5270

BOX 5120 STN. "F"  
OTTAWA, ONTARIO  
CANADA K2C 3H4  
X  
□ (613) 226-5772  
TELEX 053.4591

INSTRUCTIONS

MODEL AV-107C-PS-M-US1-P PULSE GENERATOR

S.N. :

### WARRANTY

Avtech Electrosystems Ltd. warrants products of its manufacture to be free from defects in material and workmanship under conditions of normal use. If, within one year after delivery to the original owner, and after prepaid return by the original owner, this Avtech product is found to be defective, Avtech shall at its option repair or replace said defective item. This warranty does not apply to units which have been disassembled, modified or subjected to conditions exceeding the applicable specifications or ratings. This warranty is the extent of the obligation or liability assumed by Avtech with respect to this product and no other warranty or guarantee is either expressed or implied.

Fig. 1

PULSE GENERATOR TEST ARRANGEMENT

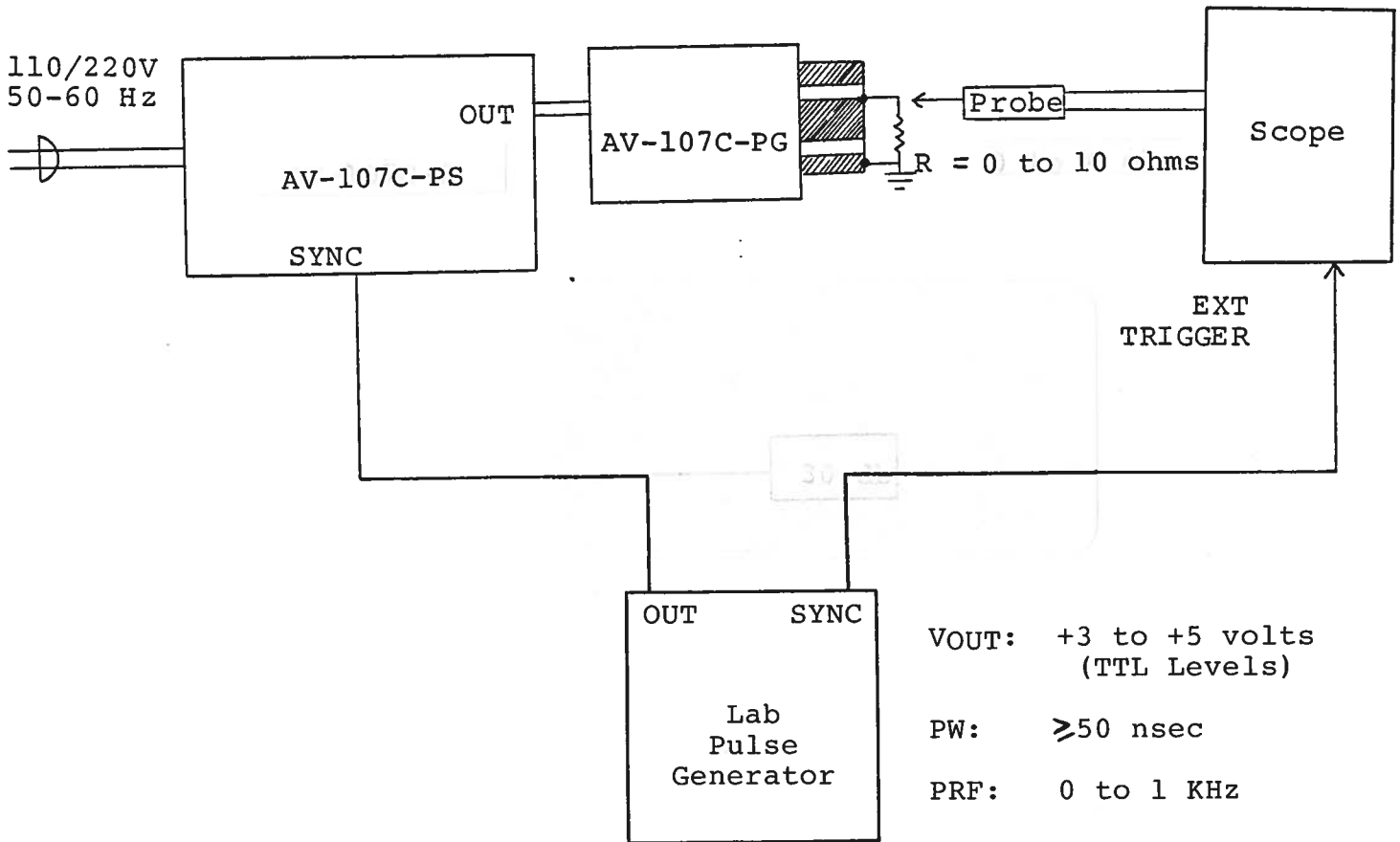

## GENERAL OPERATING INSTRUCTIONS

- 1) The equipment should be connected in the general fashion shown above. Since the unit provides an output pulse rise time as low as 10 nsec a fast oscilloscope (at least 50 MHz and preferably 200 MHz) should be used to display the waveform. Alternatively, the output current may be monitored using a current probe such as the TEKTRONIX Model CT-2.
- 2) The output pulse width is controlled by means of the front panel one turn PW control.
- 3) The output pulse amplitude is controlled by means of the front panel one turn AMP control.
- 4) The output terminals of the pulse generator module consists of a short length of microstrip transmission line protruding from the module chassis. The OUT terminal is the center conductor which is bounded on both sides by the ground plane (see below):

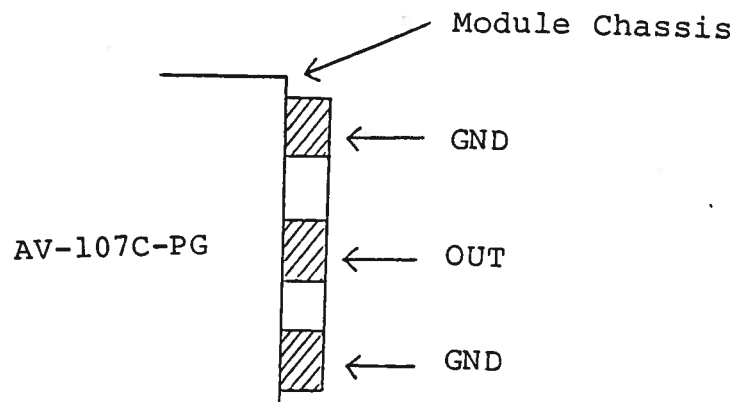

The load should be connected between the OUT and GND terminals using very short leads ( $\ll 0.5$  cm). The voltage across the load may be monitored by connecting a length of 80 mil semi-rigid 50 ohm cable as shown below (or by means of a high impedance scope probe). The current may be monitored using a current probe such as the TEKTRONIX Model CT-2.

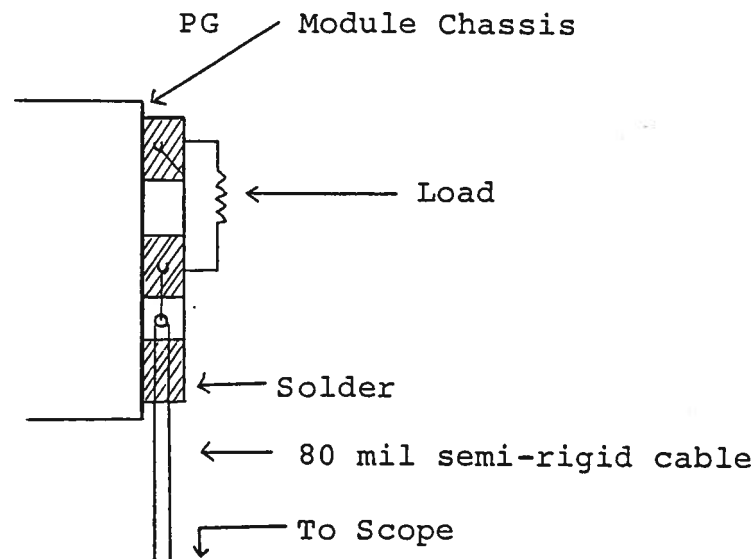

Take care to insure that during soldering the OUT conductor is not shorted to the chassis. Also, use minimal heat when soldering.

- 5) M Option. The SMA output port (M) on the AV-107-PG module provides a replica of the output pulse (when connected to a fifty ohm load). The output pulse load current and the M output voltage are related as follows:

$$I_{LOAD} = 20 V_M$$

- 6) CAUTION: The AV-107-C unit is designed to provide 0 to +10 ampere pulses to a load voltage in the range of 0 to +100 volts. If possible, the load voltage should be monitored as near as possible to 100 volts (eg. by adding series resistance) since this reduces the heating of the output switching elements and thus reduces the likelihood of failure of the SL12T switching elements (see Repair Section).

Fig. 2

FRONT PANEL CONTROLS

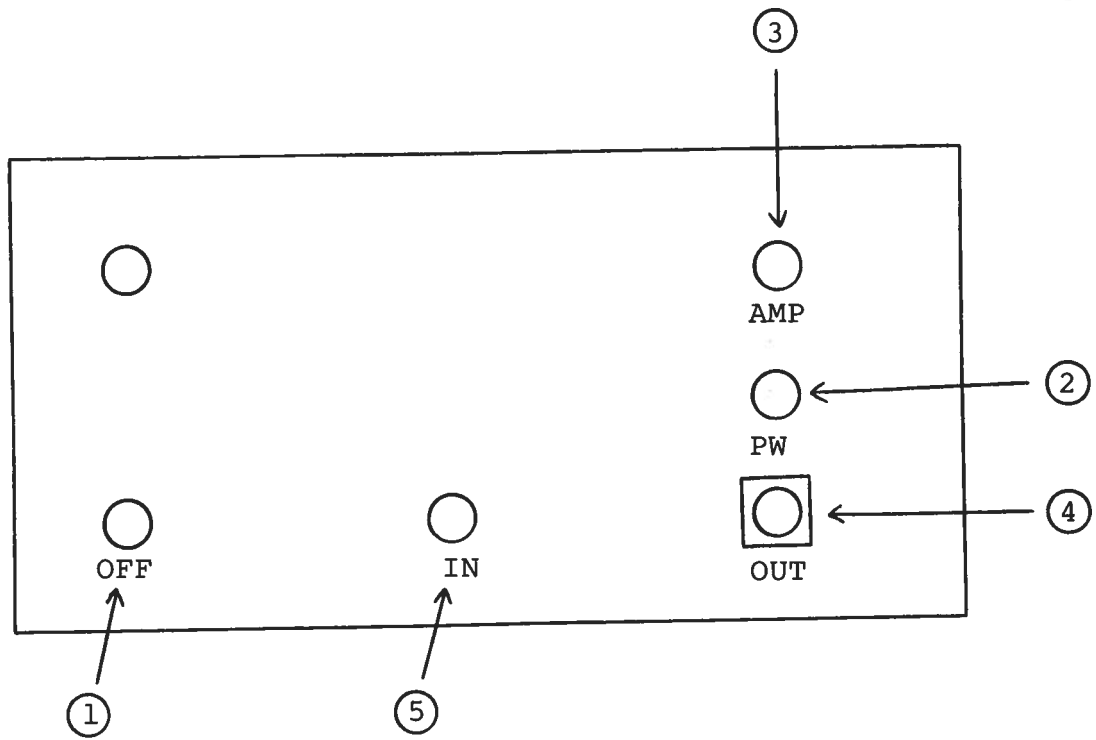

- (1) ON-OFF Switch. Applies basic prime power to all stages.
- (2) PW Control. A one turn control which varies the output pulse width from 50 nsec to 5.0 usec.
- (3) AMP Control. The output pulse amplitude is controlled by means of the one turn potentiometer (AMP).
- (4) OUT Connector. A multi pin connector which attaches the 2 foot cable from the pulse generator module to the main frame.
- (5) IN. The external trigger signal is applied at this input.

Fig. 3

BACK PANEL CONTROLS

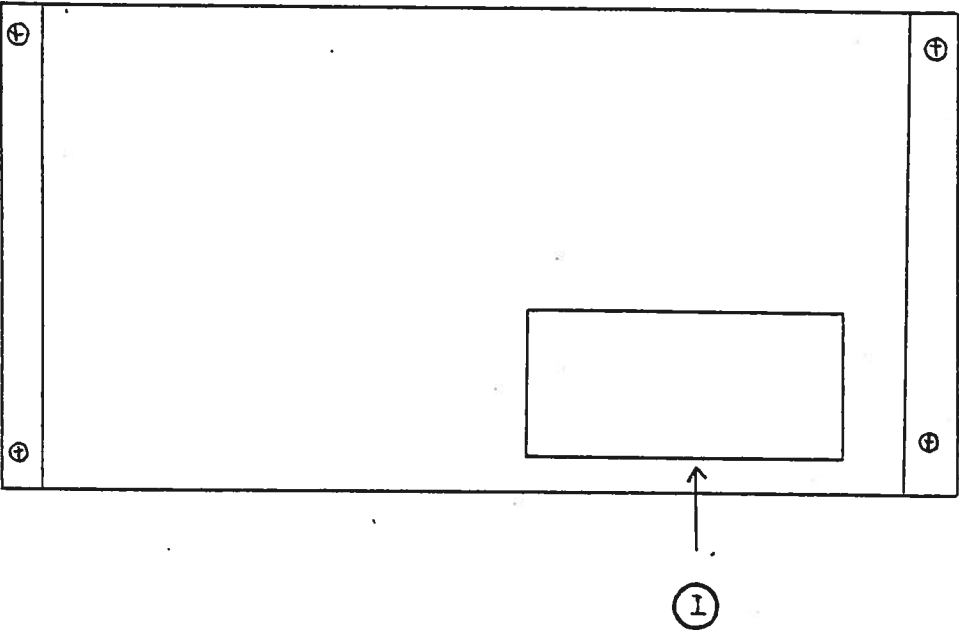



- (1) FUSED CONNECTOR, VOLTAGE SELECTOR. The detachable power cord is connected at this point. In addition, the removable cord is adjusted to select the desired input operating voltage. The unit also contains the main power fuse.

## SYSTEM DESCRIPTION AND REPAIR PROCEDURE

The AV-107C-PS unit consists of the following basic modules:

- 1) AV-107C-PG pulse generator module
- 2) +24V power supply board
- 3) +135V power supply board
- 4) -15 volts power supply module

The modules are interconnected as shown in Fig. 4.

In the event of an instrument malfunction, it is most likely that some of the output switching elements (SL12T) may have failed due to an output short circuit condition or to a high duty cycle condition. The switching elements may be accessed by removing the cover plate on the bottom side of the -PG module. The cover plate is removed by removing the four counter sunk 6-32 Phillips screws. NOTE: First turn off the prime power. CAUTION: Briefly ground the SL12T tabs to discharge the 135 volts power supply potential. The elements may be removed from their sockets by means of a needle nosed pliers after removing the four counter sunk 2-56 Phillips screws which attach the small aluminum heat sinks to the body of the AV-107-PG module. The SL12T is a selected VMOS power transistor in a TO 220 package and may be checked on a curve tracer. If defective, replacement units should be ordered directly from Avtech. When replacing the SL12T switching elements, take care to insure that the short lead (of the three leads) is adjacent to the black dot on the chassis. The SL12T elements are electrically isolated from the small aluminum heat sinks but are bonded to the heat sinks using WAKEFIELD TYPE 155 HEAT SINK ADHESIVE. If the switching elements are not defective, then the four Phillips screws on the back panel should be removed. The top cover may then be slid off and the operation of the clock and power supply modules checked. The clock module is functioning properly if:

- a) 0.1 usec TTL level outputs are observed at pins 2 and 3.
- b) The PRF of the outputs can be varied over the range of 2 Hz to 5 KHz using the PRF controls.
- c) The relative delay between the pin 2 and 3 outputs can be varied by at least 1 usec by the DELAY control.

The sealed clock module must be returned to Avtech for repair or replacement if the above conditions are not observed.

ON-OFF

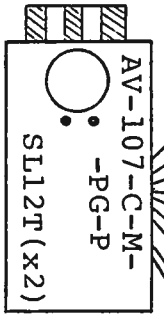
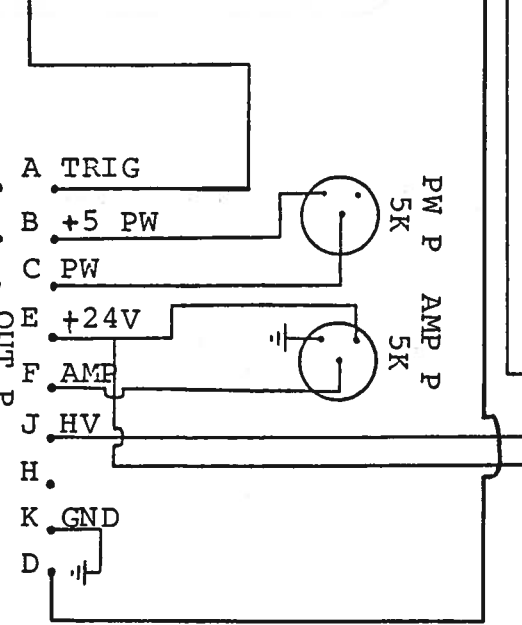
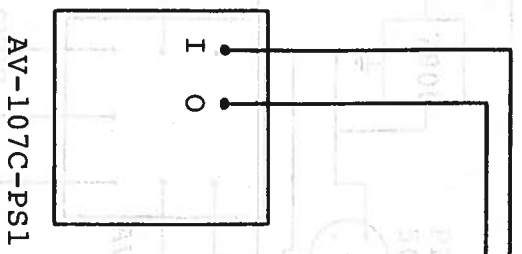
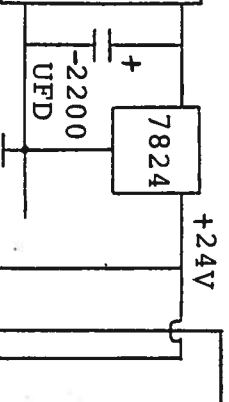
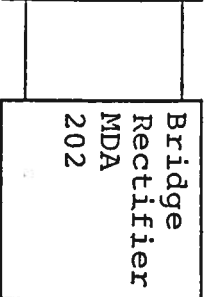
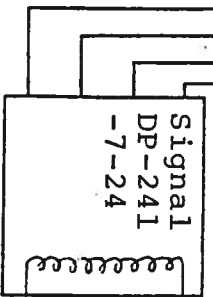
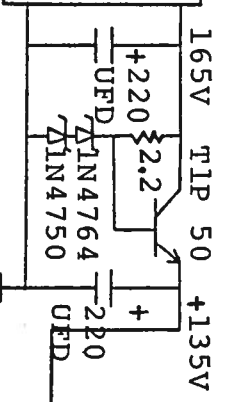
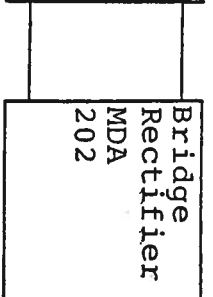
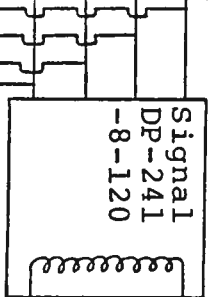
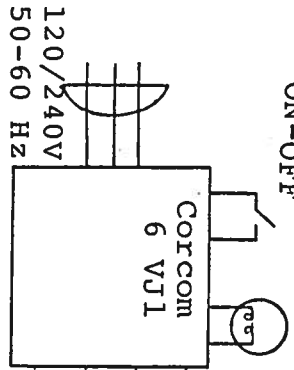

AV-107C-PS

