



AVTECH ELECTROSYSTEMS LTD.

NANOSECOND WAVEFORM ELECTRONICS
SINCE 1975

P.O. BOX 265
OGDENSBURG, NY
U.S.A. 13669-0265
TEL: (315) 472-5270
FAX: (613) 226-2802

TEL: 1-800-265-6681
FAX: 1-800-561-1970
U.S.A. & CANADA

e-mail: info@avtechpulse.com

BOX 5120 STN. F
OTTAWA, ONTARIO
CANADA K2C 3H4
TEL: (613) 226-5772
FAX: (613) 226-2802

PRELIMINARY INSTRUCTIONS
(REVISION 3)

MODEL AV-108-LUM1 LASER DIODE DRIVER

S.N.: 7215 (MOD1)

WARRANTY

Avtech Electrosystems Ltd. warrants products of its manufacture to be free from defects in material and workmanship under conditions of normal use. If, within one year after delivery to the original owner, and after prepaid return by the original owner, this Avtech product is found to be defective, Avtech shall at its option repair or replace said defective item. This warranty does not apply to units which have been disassembled, modified or subjected to conditions exceeding the applicable specifications or ratings. This warranty is the extent of the obligation or liability assumed by Avtech with respect to this product and no other warranty or guarantee is either expressed or implied.

MODIFICATION SUMMARY

Relative to SN 7215 (Dec. 94), this unit (SN 7215, MOD1) includes the following major modifications:

- 1) Gain control circuit modified to provide a linear relationship between input control voltage and output current. New circuit provides repeatable rise time from unit to unit.
- 2) Current limit function redesign so as to eliminate spurious oscillations and high input current for $V_{IN} > 5$ Volts and to provide abrupt hard adjustable limiting (355 design).
- 3) Temperature limit circuit set to trigger at about $+60^{\circ}\text{C}$. On previous version, was set at about 45°C .

Fig. 1 INPUT CONNECTIONS

MODEL AV-108-LUM1

POSITRON CONNECTOR PIN-OUT

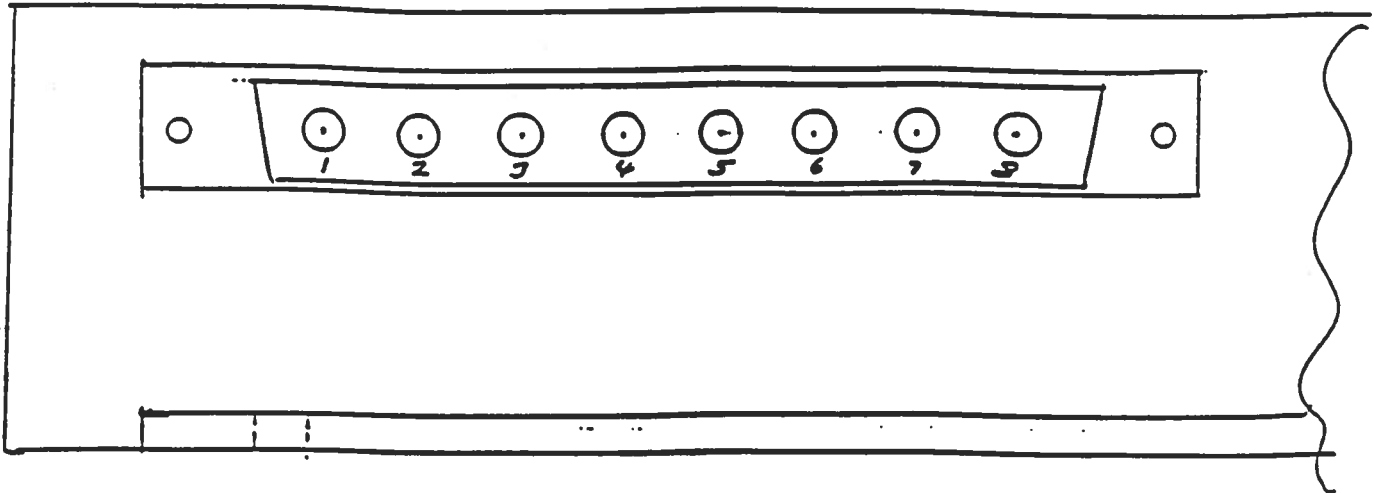

The PIN functions and characteristics are as follows:

- 1) TRIG IN, TTL, COAX. Input resistance set to 2.0K. Output pulse width is equal to the input pulse width.
- 2) AMP CONTROL, COAX. Input resistance set to 2.0K. 0 to +5 VDC causes output current to vary from 0 to up to +100 Amps, (depending on the setting of the current limit pot, see Fig. 3). Amp control circuit rise time about 2 us.
- 3) CURRENT MONITOR, COAX. Provides a voltage replica (to $R_L \geq 50$ Ohms) of the output current waveform.
- 4) +24 VDC POWER CONTACT (NOT COAX). Apply +24 VDC, (400 mA max) between the terminal and PIN 5. This supply powers all the timing and control circuits.
- 5) GROUND FOR 24 VDC (NOT COAX). See 4.
- 6) -12 VDC POWER CONTACT (NOT COAX). Apply -12 VDC (20 Amperes max) between the terminal and PIN 7. This supply powers the output stage. At maximum peak output (100 Amperes), maximum pulse width (1 ms) and max duty cycle (20%), the -12 VDC power supply must provide an average current of 20 Amperes. The output waveform will exhibit near zero droop.

- 7) GROUND FOR -12 VDC (NOT COAX). See 6.
- 8) SPARE COAX. No connection is made to this pin.

The POSITRONIC connector part numbers are as follows:

Male Shell (on Chassis): CBD8W8M000T20
Female Shell (on Cable): CBD8W8F000E0
Cable Inserts: Coax: FS4104D
Power Contacts: FS4012D

Fig. 2 OUTPUT CONNECTIONS

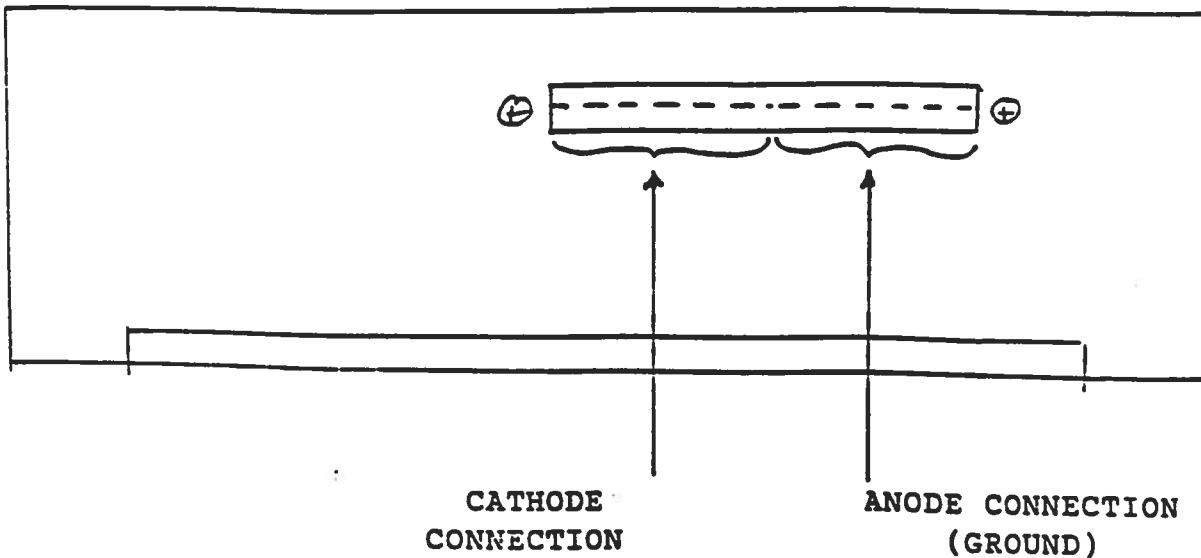

An Amp WAVECRIMP 765206-3 connector is affixed to the chassis and mates to a WAVECRIMP 765191-1 plug. The diode anode and cathode should be connected as shown in Fig. 2. The driver was tested with a 2 foot section of WAVECRIMP cable between the diode and the driver. A rise time of 8 us was observed. With a cable length of one foot, the rise time should be less than 5 us.

Fig. 3

CURRENT LIMIT CONTROL AND QUIESCENT CURRENT CONTROL

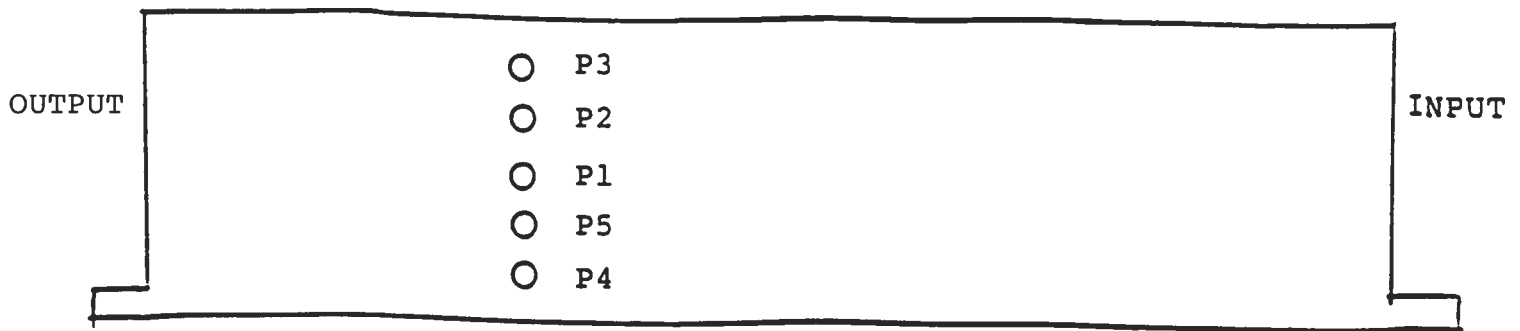

- P4) CURRENT LIMIT CONTROL. A ten turn trim pot is accessible if the 4-40 Phillips screw is removed. With the trim pot set fully CW, a +5 Volt input on the amplitude output (PIN 2, see Fig. 1) will result in a peak output of 100 Amps. With the trim pot set fully CCW, the peak output is about 10 Amperes (for +5 VDC in). This unit was shipped with the pot set fully CW (i.e. 100 Amps). (Increasing the input voltage beyond +5V will not increase the output).
- P5) QUIESCENT PULSE CURRENT CONTROL. Removing the 4-40 Phillips screw provides access to a ten turn trim pot which determines the quiescent pulse current (i.e. the pulse current which flows during the TRIG IN pulse width interval when the AMP voltage is set to zero). Note that the quiescent current between the TRIG IN pulses is set to zero (using P2). At the time of shipping, the output quiescent pulse current was set to zero. CW rotation of the P5 pot causes the quiescent pulse current to increase (to as much as 50 Amperes).

- P3) TEMPERATURE LIMIT CONTROL. A ten turn trim pot is accessible if the 4-40 Phillips screw is removed. Clockwise rotation of the trim pot lowers the temperature at which the sensing circuit overrides the amplitude control feature and reduces the peak output to zero. At the time of shipping, the control was set to trigger when the case of the output transistor reached +60°C. If it is found that the sensing circuit is triggering unnecessarily, then rotate the screw 1 or 2 times counter clockwise. Note that after the sensing current triggers (and reduces the output amplitude to zero) it will automatically reset after the internal temperature falls.
- P2) QUIESCENT CURRENT CONTROL. A ten turn control for factory adjustment of quiescent current level between trigger pulses. Set to zero at time of shipping.
- P1) CURRENT GAIN CONTROL. A ten turn pot for factory adjustment of 100 Ampere out for 5 Volts in.

BASIC GAIN CALIBRATION PROCEDURE

- 1) Rotate P4 fully CW.
- 2) Set V_{IN} at +5 Volts and adjust P1 to obtain 100 Amps out.
- 3) Set V_{IN} at +1 Volts and adjust P2 to obtain 20 Amperes out.
- 4) Repeat step 2 and then step 3 to confirm that 100 and 20 Amp values are still obtained.
- 5) To limit the maximum output to 70 Amperes do either A) or B):
 - A) Set V_{IN} at +5 Volts to obtain 100 Amps and then rotate P4 CCW until output amplitude decreases to 70 Amperes. To insure linear operation up to 70 Amperes, the P4 pot should then be rotated CW a few times.
 - B) Set V_{IN} to +5 Volts and rotate the pot P1 to set the output to 70 Amperes. Note that increasing V_{IN} beyond 5.0 Volts will cause the output to exceed 70 Amperes and note also that 1 Volt in will not provide 20 Amperes.

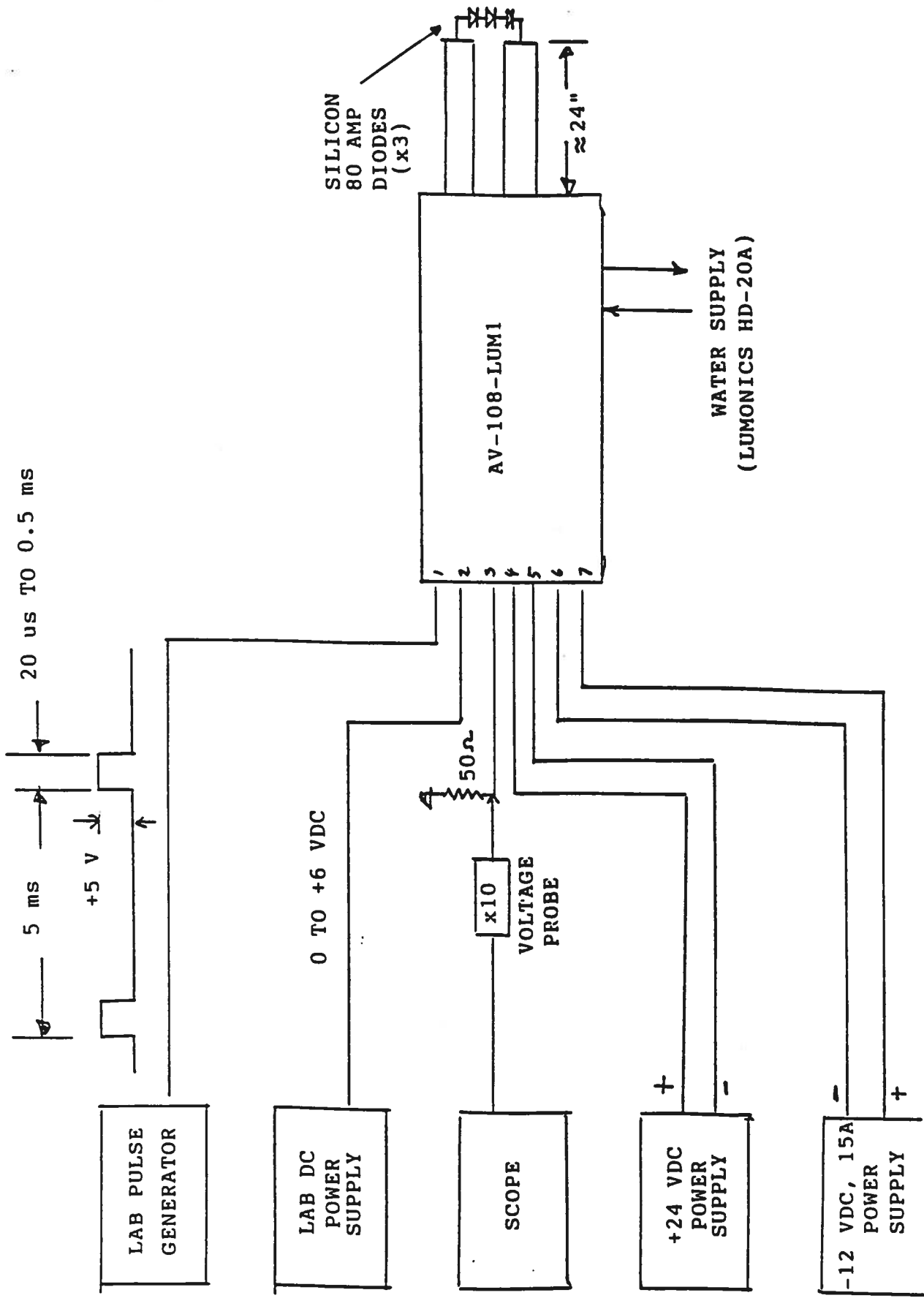
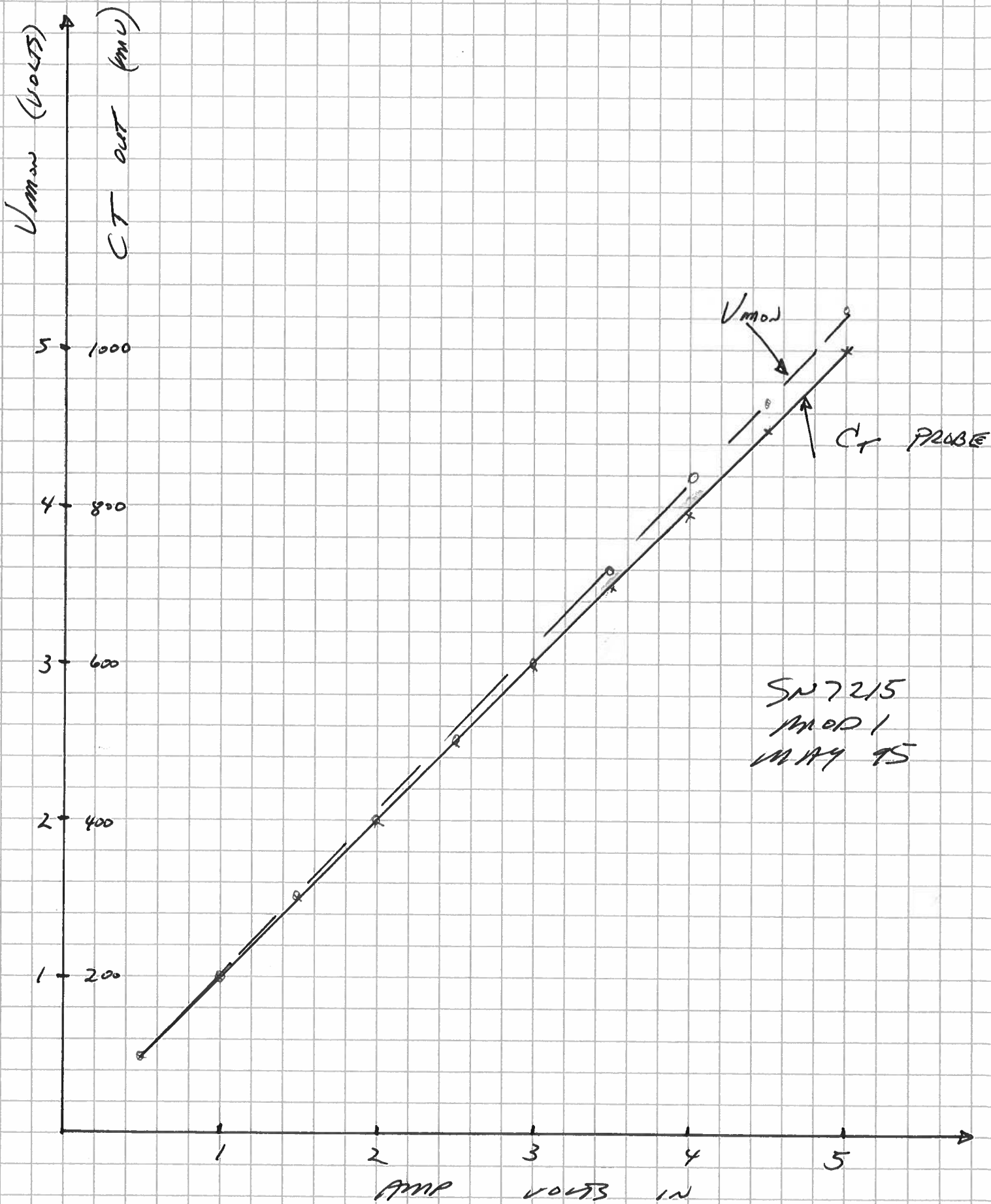

Fig. 5 SYSTEM TEST SET-UP

The basic arrangement shown in Fig. 5 was used to confirm the general operation of the unit. The turn on procedure was as follows:

- 1) Contact to water supply and turn on water.
- 2) Set lab pulse generator to +5V, 20 us, 200 Hz.
- 3) Set Amp control power supply to 0V (PIN 2).
- 4) Turn on +24 VDC power supply. Should draw about 450 mA.
- 5) Turn on -12 VDC power supply. Should draw zero current.
- 6) Gradually increase the Amp control supply from 0 to +1.0 Volts. The monitor output should provide a rectangular output pulse (of 1 Volt = 20 Amperes) and the -12 VDC power supply should supply a low current.
- 7) Increase the Amp control supply to +5 Volts. The monitor output should give a +5 Volt pulse (i.e. 100 Amperes) and the -12 VDC power supply should be supplying about 0.5 Amperes.
- 8) Increase the pulse width to 0.7 ms. The current drawn from the -12 V power supply should increase to 14 Amperes.
- 9) Decrease the Amp control voltage to zero and the -12 V supply current should reduce to zero as well.



PULSE GENERATOR
PERFORMANCE CHECK

Model: *AV-108-Lum 1*

S.N.: *7215 (MOD 1)*

Date: *MAY 29 95*

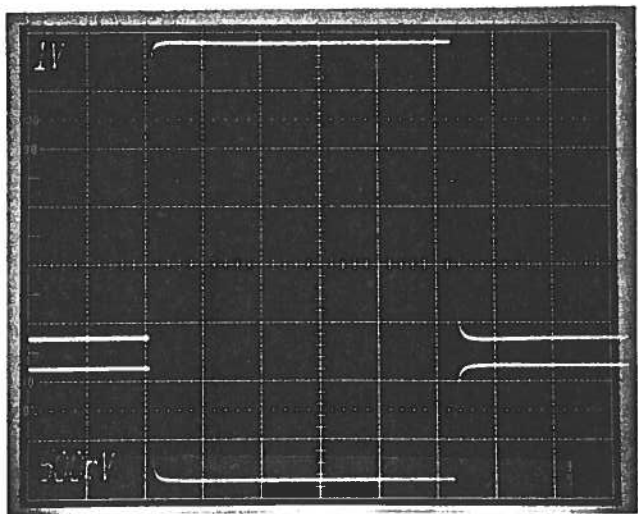

V_{max}
CT
PROBE

- a) Output signal amplitude:
0 TO +100 AMP
- b) Pulse width:
10 μ S TO 1.0 MS
- c) Rise time:
20% MAX DUTY CYCLE
 ≤ 74)
- d) Fall time:
 $\leq 7 \mu$ S
- e) PRF:
0 TO 1 KHz
- f) Jitter, stability:
20% MAX DUTY CYCLE
OK

Ⓜ *100 μ S/DIV, $\bar{I} = 14$ AMP*
 $\Delta \bar{I} = 100$ AMP
TOP: V_{max} out
DOT: ION PHYSICS PROBE out

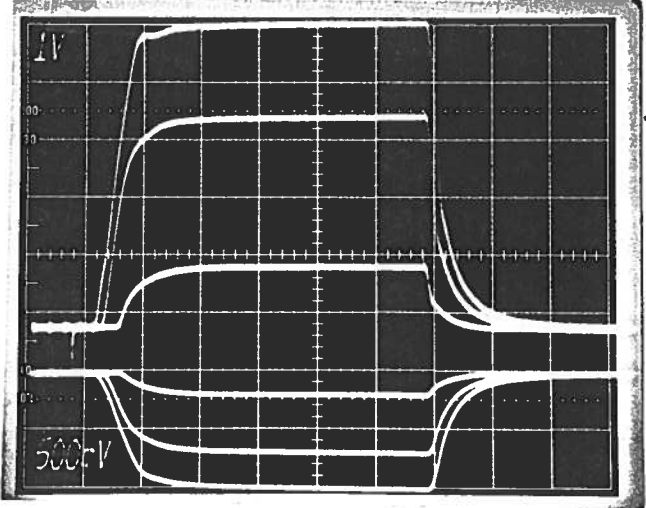

- g) Prime power:
U_{in} = 5.00V a) *+24VDC, 500mA*
U_{in} = 3.50V b) *-12VDC, 20 AMP*
U_{in} = 1.00V

Ⓜ *10 μ S/DIV $\bar{I} = 1.0$ AMP*
 $\Delta \bar{I} = 100, 70 \text{ \& } 20$ AMP

[Signature]

May 29/95

Disk: AV-108

Name: 7215MOD1.INS