



AVTECH ELECTROSYSTEMS LTD.

NANOSECOND WAVEFORM ELECTRONICS
SINCE 1975

P.O. BOX 265
OGDENSBURG, NY
U.S.A. 13669-0265
TEL: (315) 472-5270
FAX: (613) 226-2802

TEL: 1-800-265-6681
FAX: 1-800-561-1970
U.S.A. & CANADA

e-mail: info@avtechpulse.com

BOX 5120 STN. F
OTTAWA, ONTARIO
CANADA K2C 3H4
TEL: (613) 226-5772
FAX: (613) 226-2802

INSTRUCTIONS

MODEL AV-149-BW2-2K-APD-SP1-B TRANSIMPEDANCE AMPLIFIER

S.N.:

WARRANTY

Avtech Electrosystems Ltd. warrants products of its manufacture to be free from defects in material and workmanship under conditions of normal use. If, within one year after delivery to the original owner, and after prepaid return by the original owner, this Avtech product is found to be defective, Avtech shall at its option repair or replace said defective item. This warranty does not apply to units which have been disassembled, modified or subjected to conditions exceeding the applicable specifications or ratings. This warranty is the extent of the obligation or liability assumed by Avtech with respect to this product and no other warranty or guarantee is either expressed or implied.

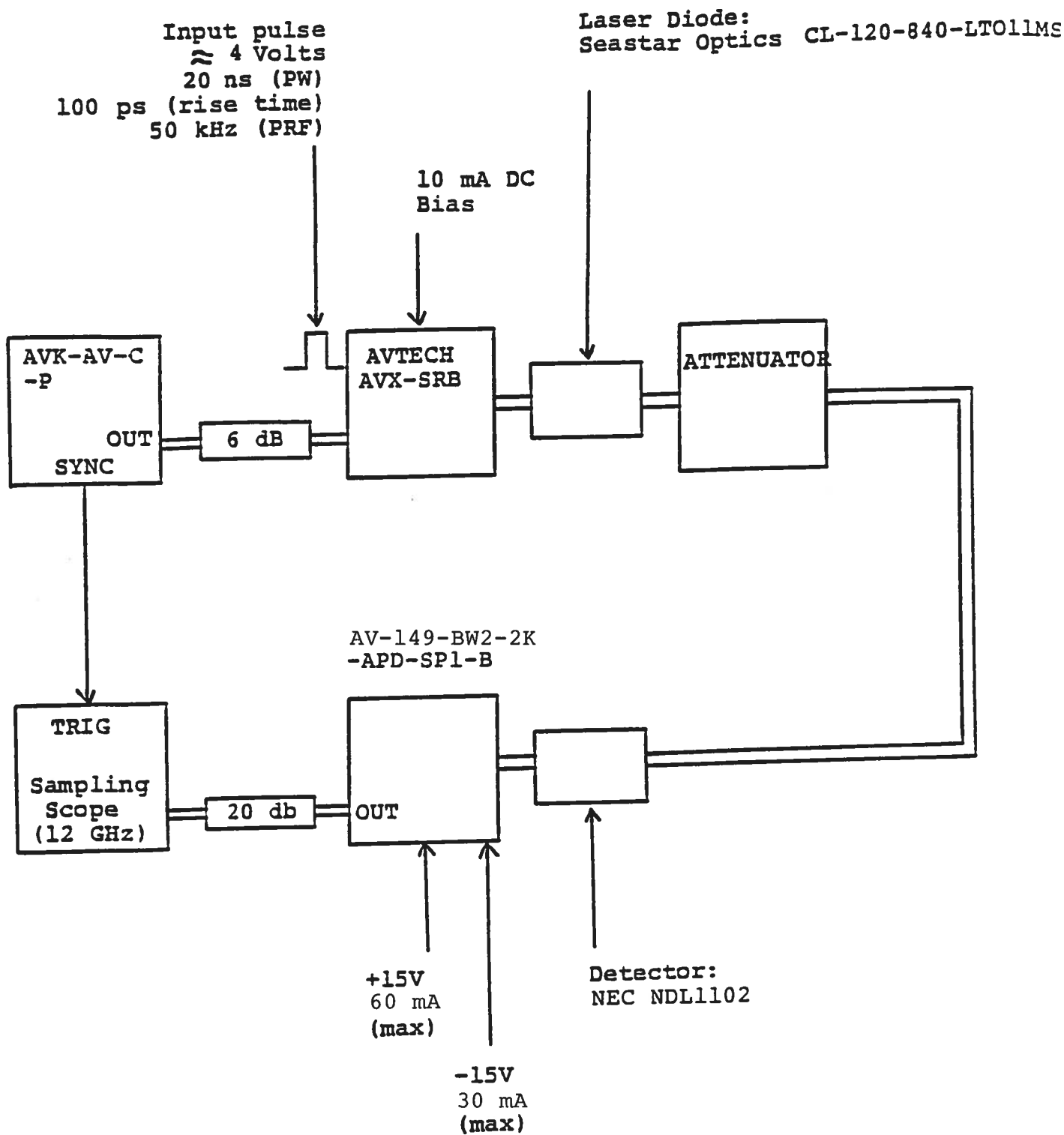

Fig. 1

BASIC TEST SET-UP (PULSE MODE)

GENERAL OPERATING INSTRUCTIONS

- 1) The basic operation of the amplifier was confirmed using the pulse mode test arrangement shown in Fig. 1.
- 2) The AV-149 amplifier requires a prime power of ± 15 VDC (60 mA max).
- 3) The bias voltage for the APD may be varied from about +20 Volts to +228 using the 10 turn "BIAS ADJ" screw. Note clockwise rotation of the screw reduces the bias voltage while counterclockwise rotation increases the bias voltage. At the time of shipping this voltage was set to +50 Volts (as measured at the red "BIAS" banana terminal adjacent to the "BIAS ADJ" screw).
- 4) The DC offset on the output may be varied from -1.0 to +1.0 Volt using the ten turn OS control. Clockwise rotation of the pot shifts the offset more negative. At the time of shipping the offset was set to zero.
- 5) To test the AV-149 in a sweep frequency mode (DC to 150 MHz) the AVK-AV-C and the sampling scope should be replaced by a network analyzer.
- 6) **CAUTION:** The amplifier will be damaged if the anode and cathode connections are reversed. Also, the photodiode must not be installed or removed once the ± 15 V prime power is on and the breakdown voltage of the diode must exceed the applied bias levels. The warranty does not apply to failures resulting from abuses related to the above.
- 7) The leads of the photo diode should not be inserted more than 1.0 cm into the socket.
- 8) The ± 15 VDC supply should be turned off when installing or removing the photo diode.
- 9) For additional information:

Tel: (613) 226-5772
Fax: (613) 226-2802

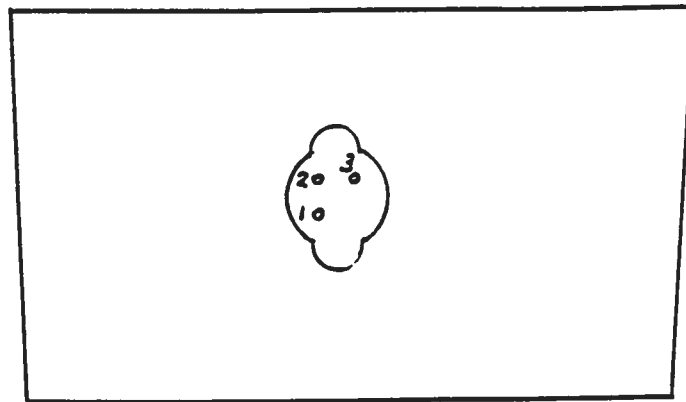

Fig. 2 DIODE SOCKET PIN CONNECTIONS

- 1) ANODE
- 2) CASE
- 3) CATHODE

Nov 7/96

Disk: AV-

Name: 149BW22K.INS