



AVTECH ELECTROSYSTEMS LTD.

NANOSECOND WAVEFORM ELECTRONICS
SINCE 1975

☐ P.O. BOX 265
OGDENSBURG, NY
U.S.A. 13669-0265
TEL: (315) 472-5270
FAX: (613) 226-2802

TEL: 1-800-265-6681
FAX: 1-800-561-1970

e-mail: info@avtechpulse.com
<http://www.avtechpulse.com>

☐ P.O. BOX 5120 STN. F
OTTAWA, ONTARIO
CANADA K2C 3H4
TEL: (613) 226-5772
FAX: (613) 226-2802

INSTRUCTIONS

MODEL AV-151F-C

0 to 2 AMP, 20 kHz

**CURRENT-OUTPUT
FUNCTION GENERATOR
and
VOLTAGE-TO-CURRENT
CONVERTER**

SERIAL NUMBER: _____

WARRANTY

Avtech Electrosystems Ltd. warrants products of its manufacture to be free from defects in material and workmanship under conditions of normal use. If, within one year after delivery to the original owner, and after prepaid return by the original owner, this Avtech product is found to be defective, Avtech shall at its option repair or replace said defective item. This warranty does not apply to units which have been disassembled, modified or subjected to conditions exceeding the applicable specifications or ratings. This warranty is the extent of the obligation assumed by Avtech with respect to this product and no other warranty or guarantee is either expressed or implied.

TECHNICAL SUPPORT

Phone: 613-226-5772 or 1-800-265-6681

Fax: 613-226-2802 or 1-800-561-1970

E-mail: info@avtechpulse.com

World Wide Web: <http://www.avtechpulse.com>

TABLE OF CONTENTS

WARRANTY	2
TECHNICAL SUPPORT	2
TABLE OF CONTENTS	3
INTRODUCTION	4
SPECIFICATIONS	4
INSTALLATION	5
VISUAL CHECK	5
PLUGGING IN THE INSTRUMENT	5
FRONT PANEL CONTROLS	6
REAR PANEL CONTROLS	8
GENERAL INFORMATION	9
BASIC PULSE CONTROL – INTERNAL MODE	9
BASIC PULSE CONTROL – EXTERNAL MODE	9
TOP COVER REMOVAL	10
RACK MOUNTING	10
OPEN AND SHORT CIRCUITS	10
OPERATIONAL CHECK	11
MAINTENANCE	13
CALIBRATION	13
NULLING CONSTANT CURRENT OFFSETS WITH TP2	13
ADJUSTING OUTPUT IMPEDANCE WITH TP3	13
OTHER REGULAR MAINTENANCE	14
POWER FAILURE AND FUSE REPLACEMENT	14
PERFORMANCE CHECK SHEET	16

INTRODUCTION

The Model AV-151F-C function generator can produce square, sine, and triangle wave outputs at frequencies up to 20 kHz, with amplitudes of 0 to $\pm 2A$, and a DC offset of 0 to $\pm 0.5A$.

When supplied with an external voltage input, the AV-151F-C may be used as a DC to 20 kHz variable-gain voltage-to-current converter/amplifier. The gain is variable from 0 to +1 Amp/Volt.

The Model AV-151F-C function generator is a current-output generator. The current amplitude is largely independent of the load voltage. For proper operation, the load voltage ($V_{LOAD} = I_{LOAD} \times R_{LOAD}$) must lie in the range of -5V to +5V.

SPECIFICATIONS

Model:	AV-151F-C
Output amplitude (max):	± 2.0 Amps
Compliance voltage:	± 5 Volts
Frequency:	DC to 20 kHz
Waveforms:	sine, square, triangle
DC offset:	± 0.5 Amps
Rise time (for max output):	10 μ s
Ext trig mode:	Input amplitude for maximum output: ± 2 Volts
Connectors:	BNC
Power requirement:	120/240 Volts (switchable) 50 - 60 Hz
Dimensions:	100 mm x 215 mm x 375 mm (3.9" x 8.5" x 14.8")

INSTALLATION

VISUAL CHECK

After unpacking the instrument, examine to ensure that it has not been damaged in shipment. Visually inspect all connectors, knobs, liquid crystal displays (LCDs), and the handles. Confirm that a power cord and two instrumentation manuals (this manual and the "OP1B Interface Programming Manual") are with the instrument. If the instrument has been damaged, file a claim immediately with the company that transported the instrument.

PLUGGING IN THE INSTRUMENT

Examine the rear of the instrument. There will be a male power receptacle, a fuse holder and the edge of the power selector card visible. Confirm that the power selector is in the correct orientation - it should be marked either 120 or 240, indicating whether it expects 120V AC or 240V AC. If it is not set for the proper voltage, remove the fuse and then grasp the card with a pair of pliers and remove it. Rotate horizontally through 180 degrees. Reinstall the card and the correct fuse. In the 120V setting, a 1A slow blow fuse is required. In the 240V setting, a 0.5A slow blow fuse is required.

FRONT PANEL CONTROLS

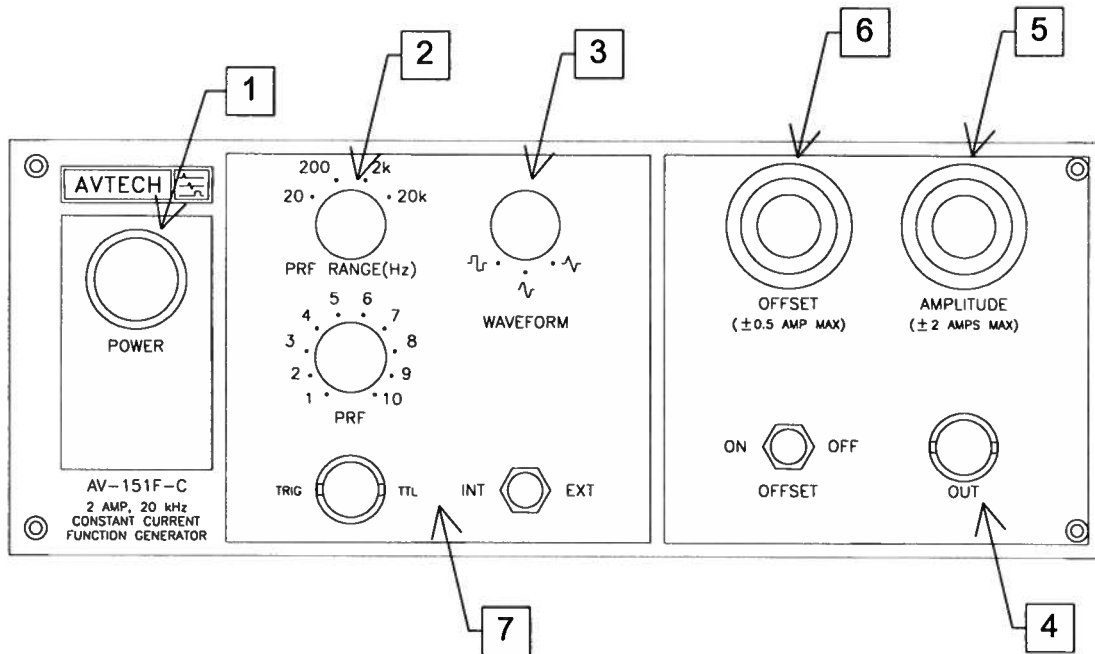

1. **POWER Switch.** The POWER push button switch applies AC prime power to the primaries of the transformer, turning the instrument on. The push button lamp (#382 type) is connected to the +15V DC supply.
2. **PRF Controls.** Varies output pulse repetition frequency (PRF) as follows:

Range 1	2 to 20 Hz
Range 2	20 to 200 Hz
Range 3	200 to 2000 Hz
Range 4	2000 to 20000 Hz
3. **WAVEFORM Switch.** This 3-position switch selects between square, sine or triangular output at the main output.
4. **OUT Connector.** This BNC connector provides the main output signal.
5. **AMPLITUDE Control.** This ten-turn control determines amplitude of the signal at the main output.
6. **OFFSET Control.** This ten-turn control allows a DC offset to be added to the signal on the main output. ON-OFF switch turns the DC offset feature on or off.

7. INT-EXT, TRIG. With this two-position switch in the INT position, the frequency and shape of the 20 Hz to 200 kHz component on the main output are determined by controls (2) and (3). Also, in this position a ± 10 Volt square wave (with an output impedance of 1 k Ω) is provided at the TRIG BNC connector for the purpose of triggering a scope.

When the two-position switch is in the EXT position, the AV-151F-C may be used as a DC-20 kHz variable-gain voltage-to-current converter/amplifier. The gain is variable from 0 to +1 Amp/Volt. The required input signal is applied at TRIG for this mode of operation.

REAR PANEL CONTROLS

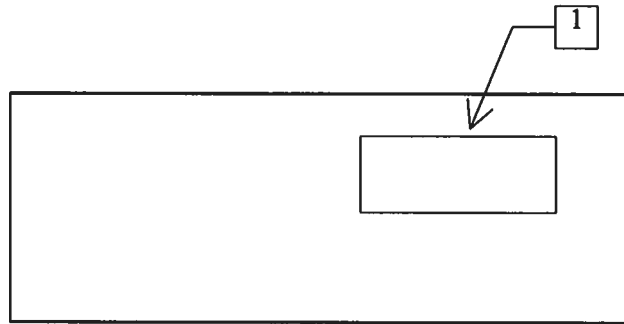

1. AC POWER INPUT. A three-pronged recessed male connector is provided on the back panel for AC power connection to the instrument. Also contained in this assembly is a 1A slow blow fuse and a removable card that can be removed and repositioned to switch between 120V AC in and 240V AC in.

GENERAL INFORMATION

BASIC PULSE CONTROL – INTERNAL MODE

Operation in the internal mode is straightforward. The output may be set to be a triangle, sine, or square wave, as illustrated below:

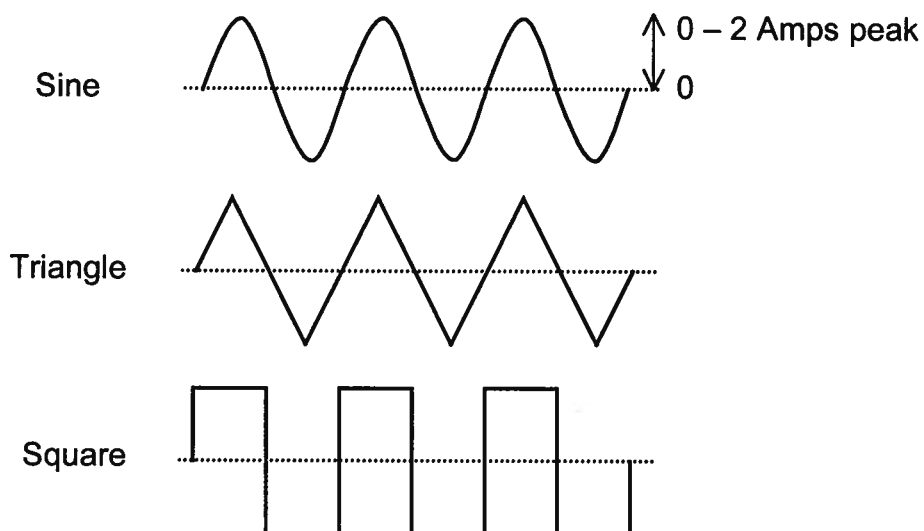

A DC offset may also be added:

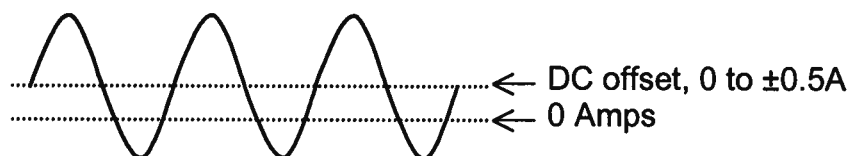

BASIC PULSE CONTROL – EXTERNAL MODE

When the "INT/EXT" switch is in the "EXT" position, the AV-151F-C may be used as a DC-20 kHz variable-gain voltage-to-current converter/amplifier. The gain is variable from 0 to +1 Amp/Volt, and is adjusted by rotating the amplitude control.

The required voltage input signal is applied at TRIG for this mode of operation.

This mode is illustrated below:

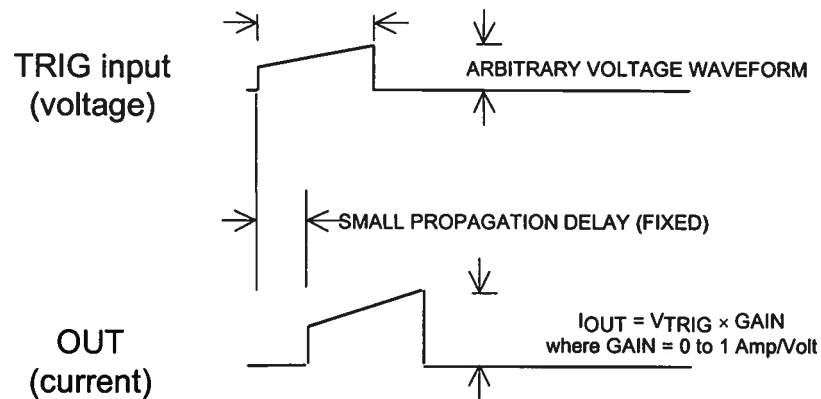

Caution: In this mode, the RMS (root mean square) output current must not exceed 1.7 Amps, and the peak output current must not exceed $\pm 2A$. If these limits are exceeded, the internal fuses may fail. See the "Maintenance" section for details on fuse replacement.

TOP COVER REMOVAL

The top cover of the instrument may be removed by removing the four Phillips screws on the top panel. With these four screws removed, the top panel may be slid off by pulling it towards the rear.

The instrument should not be accessed internally unless it has been turned off for ten minutes, to allow all internal capacitors to discharge. The internal capacitor bank stores a considerable amount of energy.

RACK MOUNTING

A rack mounting kit is available. The -R5 rack mount kit may be installed after first removing the one Phillips screw on the side panel adjacent to the front handle.

OPEN AND SHORT CIRCUITS

The AV-151F-C will operate properly into a short circuit to ground, or into an open (i.e., unconnected) circuit.

OPERATIONAL CHECK

This section describes a sequence to confirm the basic operation of the instrument. It should be performed after receiving the instrument. It is a useful learning exercise as well.

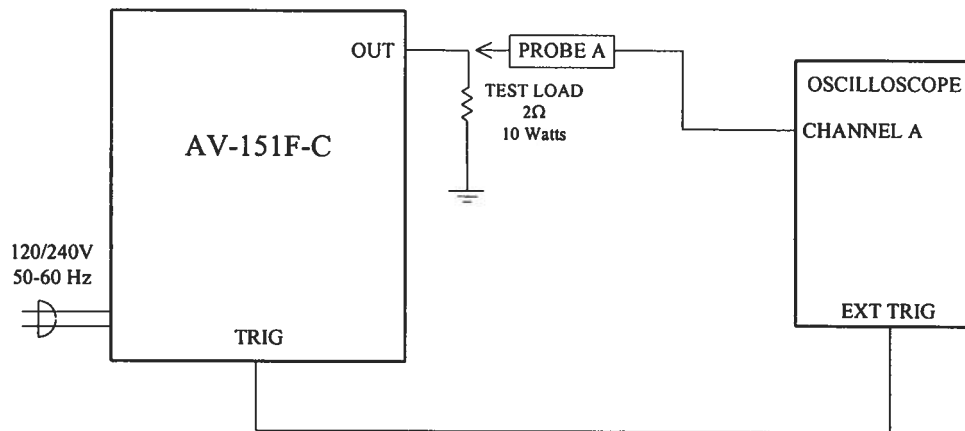

Basic Test Arrangement

- 1) Connect a 10W, 2Ω test load between the OUT connector and ground.
- 2) Connect a cable from the SYNC OUT connector to the TRIG input of an oscilloscope. Set the oscilloscope to trigger externally.
- 3) Connect one oscilloscope probe (channel A) to the OUT load. On the oscilloscope, set the channel A vertical scale to 2 V/div, and the horizontal scale to 20 μs/div.
- 4) Turn on the AV-151F-C.
- 5) Set the PRF range switch to the 20 kHz range, and rotate the PRF fine control fully clockwise.
- 6) Set the INT/EXT switch to "INT".
- 7) Set the waveform switch to the sine wave position.
- 8) Set the Offset ON/OFF switch to "OFF".
- 9) Rotate the amplitude ten-turn dial to its maximum setting.
- 10) Observe the oscilloscope. You should see a sine wave with a 50 us period, and 8V peak-to-peak amplitude.

- 11) Observe the waveform as you switch between the sine, triangle, and square wave modes using the waveform switch.
- 12) Switch the Offset ON/OFF switch to "ON", and rotate the offset ten-turn dial. The output waveform should shift vertically on the oscilloscope.
- 13) This completes the operational check.

If additional assistance is required:

Tel: (613) 226-5772, Fax: (613) 226-2802
Email: info@avtechpulse.com

MAINTENANCE

CALIBRATION

The output stage has five trimming potentiometers ("trimpots") that can be used to adjust the performance of the output circuit. These trimpots are preset at the factory and should not normally require adjusting after delivery. (If your facility requires periodic calibration of all instruments, we suggest a 2 year interval between adjustments.) These controls can be accessed by removing the top panel of the instrument, and by locating the output-stage module. The output module is illustrated in the figure below.

The locations of the trimpots (designated TP1-TP5) are shown below. All should be accessible through the heatsinking.

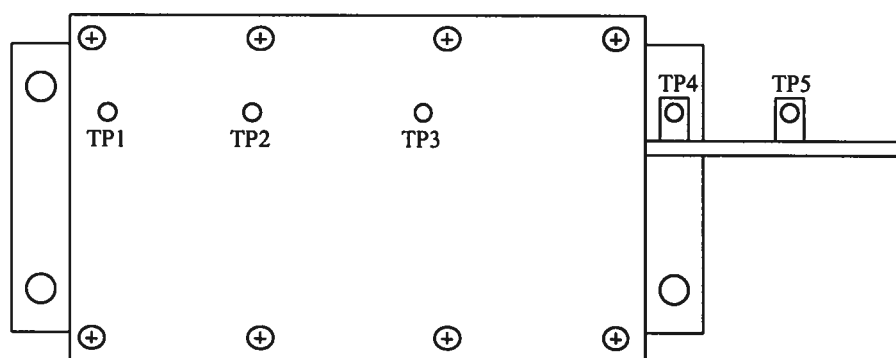

Location of Trimpots

In the AV-151F-C model, only TP2 and TP3 are active.

NULLING CONSTANT CURRENT OFFSETS WITH TP2

If a small constant current offset is observed on one of the main outputs, TP2 can be rotated to reduce it to zero.

ADJUSTING OUTPUT IMPEDANCE WITH TP3

Ideally, the outputs of the pulsed current sources should be independent of the output voltages, within the $-5V$ to $+5V$ compliance voltage range. This condition represents infinite output impedance. If a load voltage/output current dependence is present, the output impedance needs to be adjusted.

To adjust the output impedance, connect a 10W, 2.0Ω load to the output. Set the output amplitude to maximum (i.e. 4 Amps, peak-to-peak), and the waveform to "square".

Observe the load voltage on an oscilloscope. The load voltage should have a peak-to-peak amplitude of approximately 8V (i.e. $4A \times 2\Omega = 8V$). Note the exact value. Now replace the 2.0Ω load with a 1.0Ω load. The load voltage should fall by to approximately 4V (i.e. $4A \times 1.0\Omega = 4V$). Note the exact value. If the second voltage is not exactly one-half of the first voltage, adjust TP3 and repeat *both* measurements (2.0Ω and 1.0Ω) again. Repeat as required.

OTHER REGULAR MAINTENANCE

The fan grille, located on the bottom of the instrument, should be cleaned once a year so that it does not become blocked. To clean the grille, use a high-power vacuum cleaner.

POWER FAILURE AND FUSE REPLACEMENT

This instrument has three fuses (plus one spare). One, which protects the AC input, is located in the rear-panel power entry module, as described in the "Rear Panel Controls" section of this manual. If the power appears to have failed, check the AC fuse first.

The other two fuses (plus one spare) are located on the internal DC power supply, as shown below:

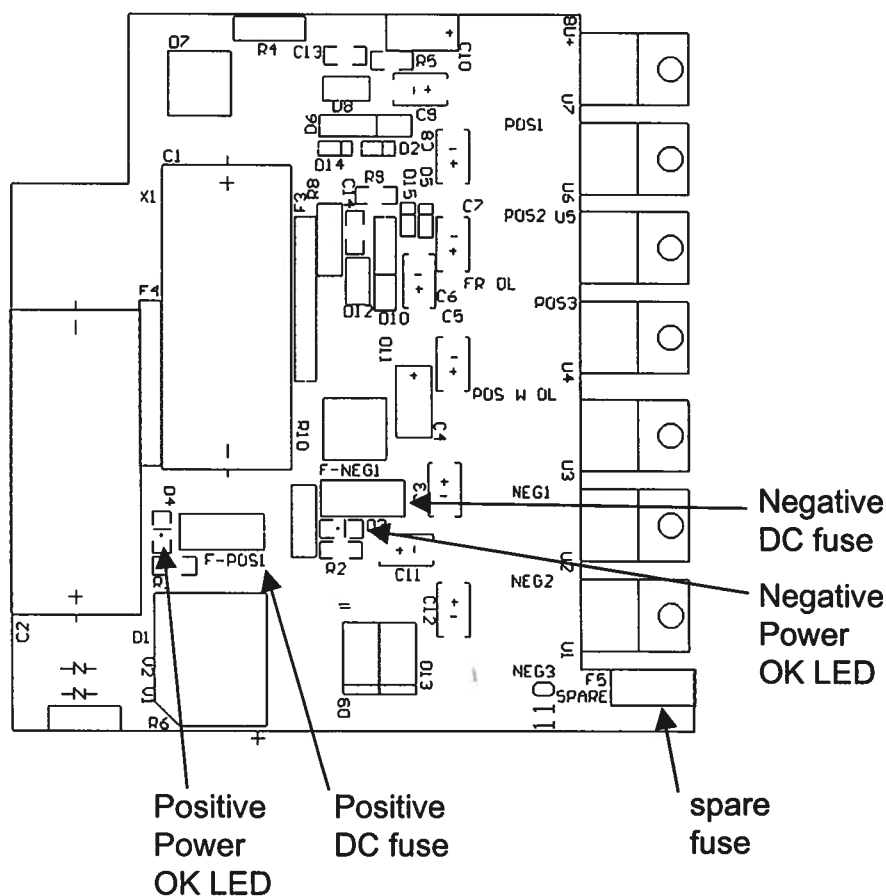

The spare fuse may be used to replace one of the other fuses, if required.

The three fuses on this circuit board are 2A slow-blow fuses, Littlefuse part number R452002. (This fuse can be ordered from Digikey, www.digikey.com. The Digikey part number is F1345CT-ND).

If you suspect that the DC fuses are blown, follow this procedure:

1. Remove the top cover.
2. Locate the two "Power OK" LEDs on the power supply circuit board, as illustrated above.
3. Turn on the instrument.
4. Observe the "Power OK" LEDs. If the fuses are not blown, the two LEDs will be lit (bright red). If one of the LEDs is not lit, the fuse next to it has blown.
5. Turn off the instrument.
6. If a fuse is blown, use needle-nose pliers to remove the blown fuse from its surface-mount holder.
7. Replace the fuse.

PERFORMANCE CHECK SHEET