



AVTECH ELECTROSYSTEMS LTD.

NANOSECOND WAVEFORM ELECTRONICS
SINCE 1975

P.O. BOX 265
OGDENSBURG, NY
U.S.A. 13669-0265
TEL: (315) 472-5270
FAX: (613) 226-2802

TEL: 1-800-265-6681
FAX: 1-800-561-1970

e-mail: info@avtechpulse.com
<http://www.avtechpulse.com/>

BOX 5120, LCD MERIVALE
OTTAWA, ONTARIO
CANADA K2C 3H4
TEL: (613) 226-5772
FAX: (613) 226-2802

INSTRUCTIONS

MODEL AV-112B-PS

0 to $\pm 135V$, 50 kHz

VARIABLE-GAIN

LINEAR AMPLIFIER

SERIAL NUMBER: _____

WARRANTY

Avtech Electrosystems Ltd. warrants products of its manufacture to be free from defects in material and workmanship under conditions of normal use. If, within one year after delivery to the original owner, and after prepaid return by the original owner, this Avtech product is found to be defective, Avtech shall at its option repair or replace said defective item. This warranty does not apply to units which have been disassembled, modified or subjected to conditions exceeding the applicable specifications or ratings. This warranty is the extent of the obligation assumed by Avtech with respect to this product and no other warranty or guarantee is either expressed or implied.

TECHNICAL SUPPORT

Phone: 613-226-5772 or 1-800-265-6681

Fax: 613-226-2802 or 1-800-561-1970

E-mail: info@avtechpulse.com

World Wide Web: <http://www.avtechpulse.com>

TABLE OF CONTENTS

WARRANTY	2
TECHNICAL SUPPORT	2
TABLE OF CONTENTS	3
INTRODUCTION	5
AVAILABLE OPTIONS	5
HIGH-VOLTAGE PRECAUTIONS	6
SPECIFICATIONS	7
EC DECLARATION OF CONFORMITY	8
INSTALLATION	9
VISUAL CHECK	9
POWER RATINGS	9
CONNECTION TO THE POWER SUPPLY	9
ENVIRONMENTAL CONDITIONS	9
FUSES	10
AC FUSE REPLACEMENT	10
DC FUSE REPLACEMENT	11
FUSE RATINGS	11
FRONT PANEL CONTROLS	12
REAR PANEL CONTROLS	13
GENERAL INFORMATION	14
BASIC CONTROL	14
MINIMIZING WAVEFORM DISTORTIONS	15
USE LOW-INDUCTANCE LOADS	15
FACTORY TEST LOAD	15
OPERATIONAL CHECK	16
MECHANICAL INFORMATION	18
TOP COVER REMOVAL	18
RACK MOUNTING	18
MAINTENANCE	19
REGULAR MAINTENANCE	19
CLEANING	19

PERFORMANCE CHECK SHEET.....20

Manual Reference: T:\instructword\av-112\AV-112B-PS, edition 1.sxw.
Last modified December 3, 2003.
Copyright © 2003 Avtech Electrosystems Ltd, All Rights Reserved.

INTRODUCTION

The AV-112B-PS is a variable-gain linear amplifier. The gain may be adjusted from +1 to +68. The input range is 0 to $\pm 2\text{V}$, and the output range is 0 to $\pm 135\text{V}$. The output can drive load impedances of $500\ \Omega$ and higher, producing average output powers of up to 40 Watts. The amplifier bandwidth is 50 kHz. The rise and fall times are less than 2 μs .

This instrument is intended for use in research and development laboratories.

AVAILABLE OPTIONS

-R5 Option: This is the optional rack-mounting kit. The R5 rack-mount kit may also be ordered separately.

HIGH-VOLTAGE PRECAUTIONS

 **CAUTION:** This instrument provides output voltages as high as ± 135 Volts, so extreme caution must be employed when using this instrument. The instrument should only be used by individuals who are thoroughly skilled in high voltage laboratory techniques. The following precaution should always be observed:

1. Keep exposed high-voltage wiring to an absolute minimum.
2. Wherever possible, use shielded connectors and cabling.
3. Connect and disconnect loads and cables only when the amplifier is turned off.
4. Keep in mind that all cables, connectors, oscilloscope probes, and loads must have an appropriate voltage rating.
5. Do not attempt any repairs on the instrument, beyond the fuse replacement procedures described in this manual. Contact Avtech technical support (see page 2 for contact information) if the instrument requires servicing.

SPECIFICATIONS

Model:	AV-112B-PS
Output Amp. (max):	± 135 Volts
Load impedance:	$\geq 500 \Omega$
Bandwidth:	50 kHz
Voltage gain (variable):	$\times 1$ to $\times 68$
Input range ² :	0 to ± 2 Volts (1 k Ω input impedance)
Rise time (for max output):	2.0 μ s
Output power, max.	40 Watts
Connectors:	BNC
Power:	100 - 240 Volts, 50-60 Hz
Dimensions:	100 mm x 430 mm x 375 mm (3.9" x 17" x 14.8")

EC DECLARATION OF CONFORMITY

We

Avtech Electrosystems Ltd.
P.O. Box 5120, LCD Merivale
Ottawa, Ontario
Canada K2C 3H4

declare that this pulse generator meets the intent of Directive 89/336/EEC for Electromagnetic Compatibility. Compliance pertains to the following specifications as listed in the official Journal of the European Communities:

EN 50081-1 Emission

EN 50082-1 Immunity

and that this pulse generator meets the intent of the Low Voltage Directive 72/23/EEC as amended by 93/68/EEC. Compliance pertains to the following specifications as listed in the official Journal of the European Communities:

EN 61010-1:2001 Safety requirements for electrical equipment for measurement, control, and laboratory use



INSTALLATION

VISUAL CHECK

After unpacking the instrument, examine to ensure that it has not been damaged in shipment. Visually inspect all connectors, knobs, and handles. Confirm that a power cord is with the instrument. If the instrument has been damaged, file a claim immediately with the company that transported the instrument.

POWER RATINGS

This instrument is intended to operate from 100 - 240 V, 50 - 60 Hz.

The maximum power consumption is 115 Watts. Please see the "FUSES" section for information about the appropriate AC and DC fuses.

This instrument is an "Installation Category II" instrument, intended for operation from a normal single-phase supply.

CONNECTION TO THE POWER SUPPLY

An IEC-320 three-pronged recessed male socket is provided on the back panel for AC power connection to the instrument. One end of the detachable power cord that is supplied with the instrument plugs into this socket. The other end of the detachable power cord plugs into the local mains supply. Use only the cable supplied with the instrument. The mains supply must be earthed, and the cable used to connect the instrument to the mains supply must provide an earth connection. (The supplied cable does this.)

ENVIRONMENTAL CONDITIONS

This instrument is intended for use under the following conditions:

1. indoor use;
2. altitude up to 2 000 m;
3. temperature 5 °C to 40 °C;
4. maximum relative humidity 80 % for temperatures up to 31 °C decreasing linearly to 50 % relative humidity at 40 °C;
5. Mains supply voltage fluctuations up to ± 10 % of the nominal voltage;
6. no pollution or only dry, non-conductive pollution.

FUSES

This instrument contains four fuses. All are accessible from the rear-panel. Two protect the AC prime power input, and two protect the internal DC power supplies. The locations of the fuses on the rear panel are shown in the figure below:

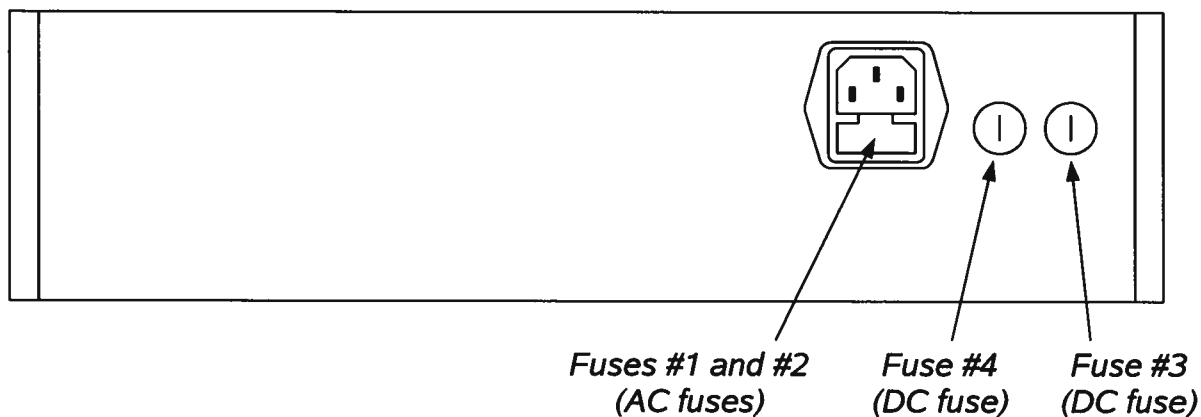

AC FUSE REPLACEMENT

To physically access the AC fuses, the power cord must be detached from the rear panel of the instrument. The fuse drawer may then be extracted using a small flat-head screwdriver, as shown below:

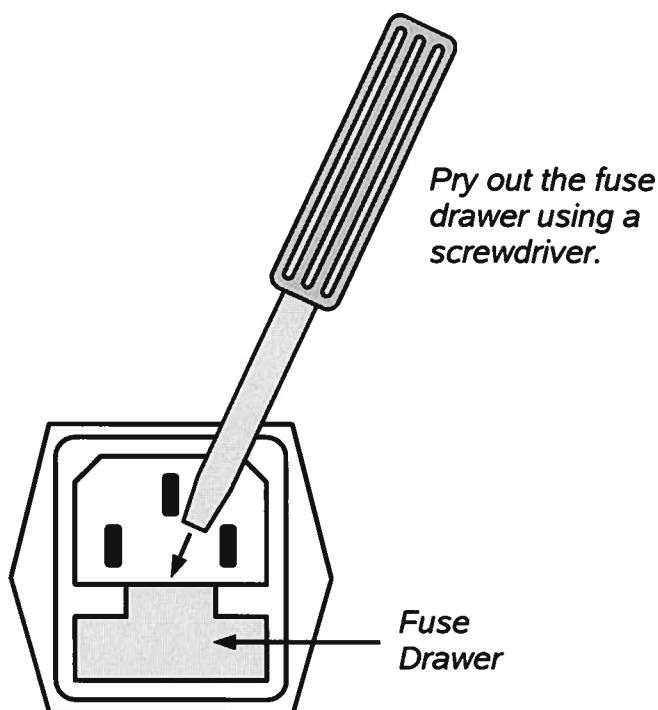

DC FUSE REPLACEMENT

The DC fuses may be replaced by inserting the tip of a flat-head screwdriver into the fuse holder slot, and rotating the slot counter-clockwise. The fuse and its carrier will then pop out.

FUSE RATINGS

The following table lists the required fuses:

Fuses	Nominal Mains Voltage	Rating	Case Size	Manufacturer's Part Number (Wickmann)	Distributor's Part Number (Digi-Key)
#1, #2 (AC)	115 V	1.0A, 250V, Time-Delay	5×20 mm	1951100000	WK5048-ND
	230 V	0.5A, 250V, Time-Delay	5×20 mm	1950500000	WK5041-ND
#3 (DC)	N/A	4.0A, 250V, Time-Delay	5×20 mm	1951400000	WK5062-ND
#4 (DC)	N/A	4.0A, 250V, Time-Delay	5×20 mm	1951400000	WK5062-ND

The fuse manufacturer is Wickmann (<http://www.wickmann.com/>).

Replacement fuses may be easily obtained from Digi-Key (<http://www.digikey.com/>) and other distributors.

FRONT PANEL CONTROLS

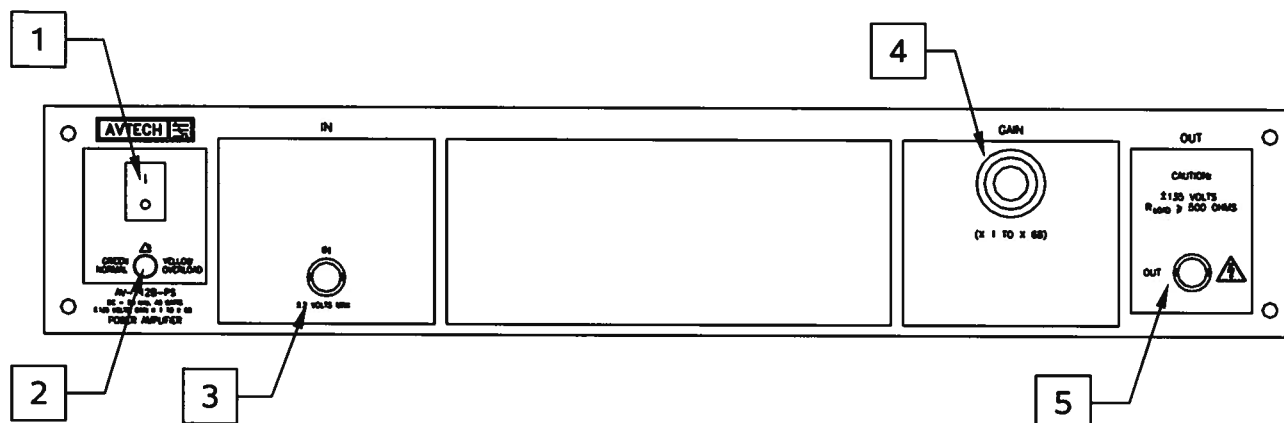

1. **POWER Switch**. This is the main power switch. When turning the instrument on, there may be a delay of several seconds before the instrument appears to respond.
2. **OVERLOAD Indicator**. When the instrument is powered, this indicator is normally green, indicating normal operation. If this indicator is yellow, an internal automatic overload protection circuit has been tripped. If the unit is overloaded (by operating at an exceedingly high duty cycle or by operating into a very low impedance), the protective circuit will disable the output of the instrument and turn the indicator light yellow. The light will stay yellow (i.e. output disabled) for about 5 seconds after which the instrument will attempt to re-enable the output (i.e. light green) for about 1 second. If the overload condition persists, the output will be disabled again (i.e. light yellow) for another 5 seconds. If the overload condition has been removed, the instrument will resume normal operation.

This overload indicator may flash yellow briefly at start-up. This is not a cause for concern.

3. **IN Connector**. The input signal is applied to this connector. The input impedance is approximately 1 k Ω . The input must not exceed $\pm 2V$.
4. **GAIN Dial**. This ten-turn dial is used to vary the amplifier gain between +1 and +68.
5. **OUT Connector**. This BNC connector provides the main output signal. The output is an amplified version of the input on (3). The gain (V_{OUT}/V_{IN}) is controlled by (4).

 **Caution:** Voltages as high as $\pm 135V$ may be present on the center conductor of this output connector. Avoid touching this conductor. Connect to this connector using standard coaxial cable, to ensure that the center conductor is not exposed.

REAR PANEL CONTROLS

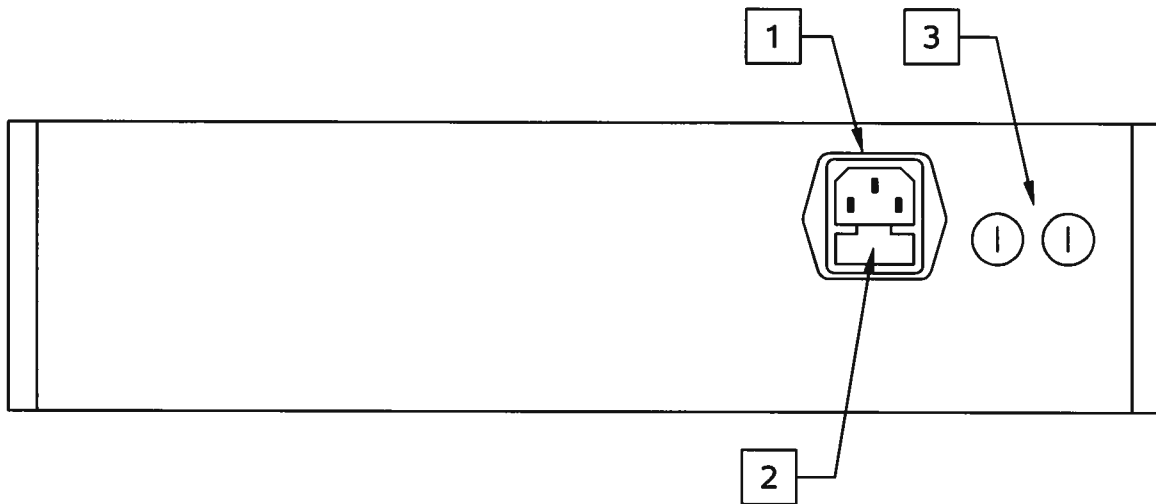

1. AC POWER INPUT. An IEC-320 C14 three-pronged recessed male socket is provided on the back panel for AC power connection to the instrument. One end of the detachable power cord that is supplied with the instrument plugs into this socket.
2. AC FUSE DRAWER. The two fuses that protect the AC input are located in this drawer. Please see the “FUSES” section of this manual for more information.
3. DC FUSES. These two fuses protect the internal DC power supplies. Please see the “FUSES” sections of this manual for more information.

GENERAL INFORMATION

BASIC CONTROL

The AV-112B-PS is a DC-50 kHz variable-gain linear amplifier. The gain is variable from +1 to +68, and is adjusted by rotating the "GAIN" control.

The required voltage input signal is applied at the "IN" connector.

This mode is illustrated below:

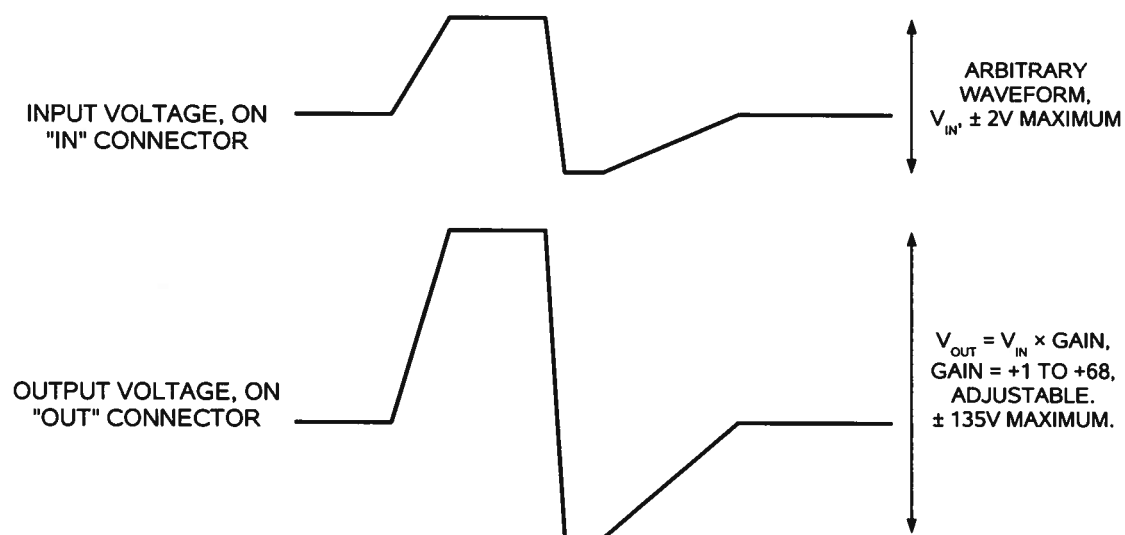

MINIMIZING WAVEFORM DISTORTIONS

USE LOW-INDUCTANCE LOADS

Lenz's Law predicts that for an inductive voltage spike will be generated when the current through an inductance changes. Specifically, $V_{\text{SPIKE}} = L \times dI_{\text{LOAD}}/dt$, where L is the inductance, I_{LOAD} is the load current change, and t is time. For this reason, it is important to keep any parasitic in the load low. This means keeping wiring short, and using low inductance components. In particular, wire-wound resistors should be avoided.

FACTORY TEST LOAD

Factory tests are conducted using a 500 Ω , 40 Watt load. This load is constructed using twenty 10 k Ω , 2 Watt low-inductance resistors in parallel. This load is shown below:

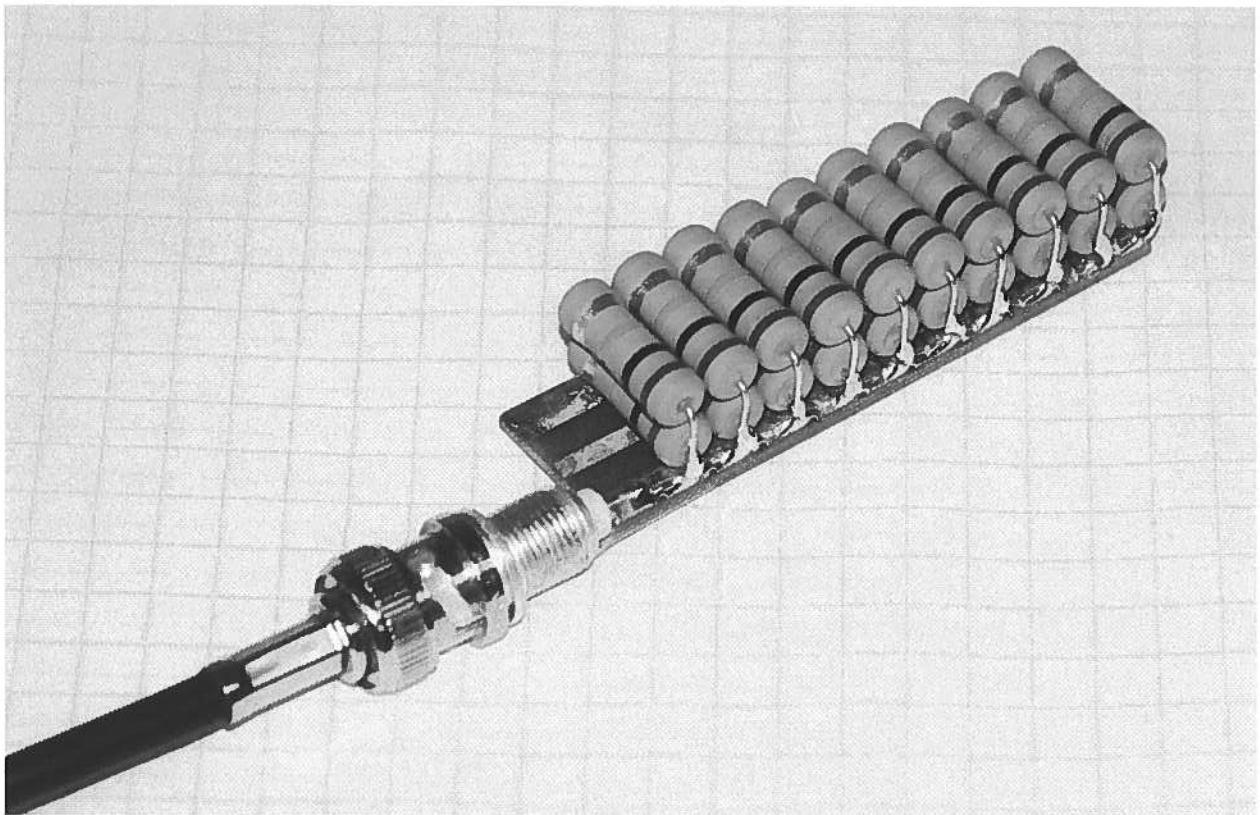

The individual 10 k Ω , 2 Watt low-inductance resistors are Ohmite OY103K parts (see <http://www.ohmite.com/> for details).

OPERATIONAL CHECK

This section describes a sequence to confirm the basic operation of the instrument. It should be performed after receiving the instrument. It is a useful learning exercise as well.

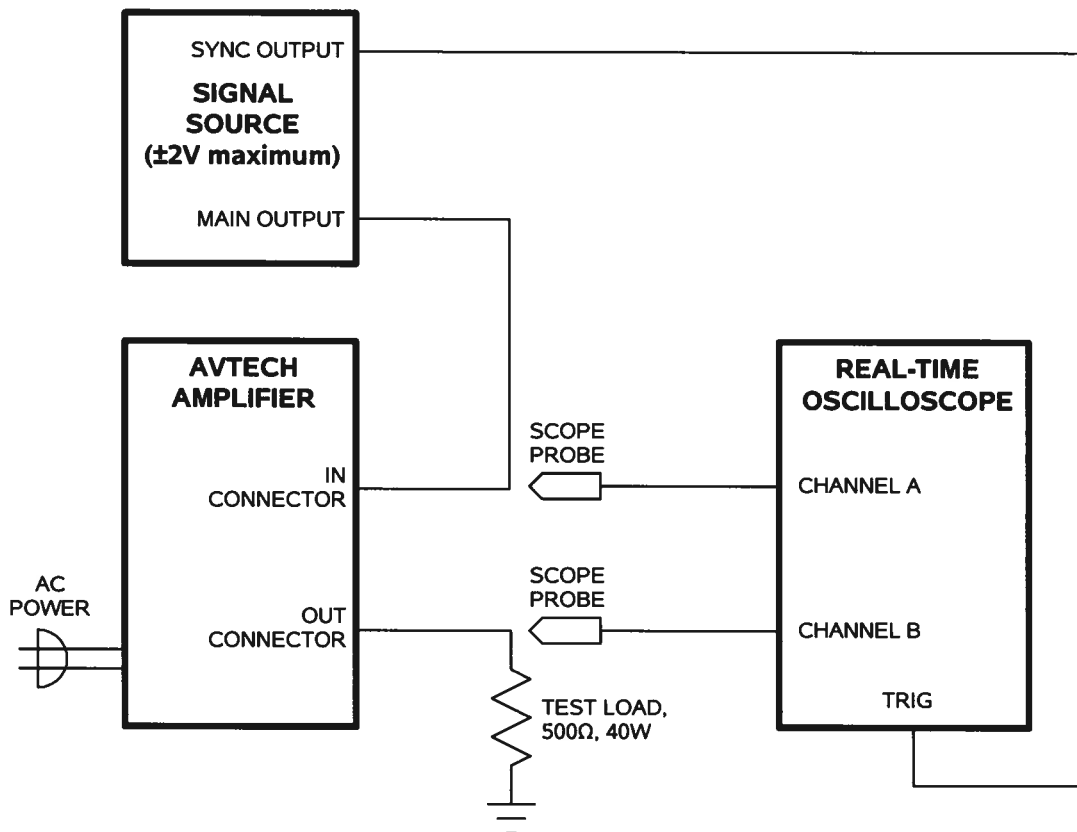

Basic Test Arrangement

- Connect a 500Ω, 40W test load between the OUT connector and ground. (See the "Factory Test Load" section for recommended resistors.) Confirm that the oscilloscope and the test load are rated for 135 Volt operation.
- Set the signal generator to produce a ±2V, 10 kHz waveform. Connect a cable from the SYNC connector of the signal generator to the TRIG input of an oscilloscope. Set the oscilloscope to trigger externally. Connect the main output of the signal generator to the input of the amplifier.
- Connect one oscilloscope probe (channel A) to the output of the signal generator. Set the Channel A vertical scale to 1 V/div.

- Connect one oscilloscope probe (channel B) to the 500 Ω load. On the oscilloscope, set the channel A vertical scale to 50 V/div, and the horizontal scale to 50 μ s/div.
- Set the gain control to minimum (0.0). Turn on the amplifier and the signal generator.
- Channel A should show a ± 2 V, 10 kHz waveform from the signal generator. Rotate the gain control to its maximum setting. The Channel B waveform should increase to ± 135 V, and have a shape similar to that of the Channel A waveform.
- This completes the operational check.

If additional assistance is required:

Tel: (613) 226-5772

Fax: (613) 226-2802

Email: info@avtechpulse.com

MECHANICAL INFORMATION

TOP COVER REMOVAL

If necessary, the interior of the instrument may be accessed by removing the four Phillips screws on the top panel. With the four screws removed, the top cover may be slid back (and off).

Always disconnect the power cord before opening the instrument.

There are no user-adjustable internal circuits. For repairs other than fuse replacement, please contact Avtech (info@avtechpulse.com) to arrange for the instrument to be returned to the factory for repair.

 **Caution:** High voltages are present inside the instrument during normal operation. Do not operate the instrument with the cover removed.

RACK MOUNTING

A rack mounting kit is available. The -R5 rack mount kit may be installed after first removing the one Phillips screw on the side panel adjacent to the front handle.

MAINTENANCE

REGULAR MAINTENANCE

This instrument does not require any regular maintenance.

On occasion, one or more of the four rear-panel fuses may require replacement. All fuses can be accessed from the rear panel. See the "FUSES" section for details.

CLEANING

If desired, the interior of the instrument may be cleaned using compressed air to dislodge any accumulated dust. (See the "TOP COVER REMOVAL" section for instructions on accessing the interior.) No other cleaning is recommended.

Dec 3 103 ed 1