



AVTECH ELECTROSYSTEMS LTD.

NANOSECOND WAVEFORM ELECTRONICS
SINCE 1975

P.O. BOX 265
OGDENSBURG, NY
U.S.A. 13669-0265
TEL: (315) 472-5270
FAX: (613) 226-2802

TEL: 1-800-265-6681
FAX: 1-800-561-1970

e-mail: info@avtechpulse.com
<http://www.avtechpulse.com>

P.O. BOX 5120 STN. F
OTTAWA, ONTARIO
CANADA K2C 3H4
TEL: (613) 226-5772
FAX: (613) 226-2802

*Pgs 24-26
are in color
→ use inkjet*

INSTRUCTIONS

MODEL AV-155C-C

0 to 2 A AMPLITUDE, 0 to 500 mA OFFSET,
0 to 4V COMPLIANCE, 50 ns RISE TIME

PULSED CONSTANT CURRENT GENERATOR

SERIAL NUMBER: _____

WARRANTY

Avtech Electrosystems Ltd. warrants products of its manufacture to be free from defects in material and workmanship under conditions of normal use. If, within one year after delivery to the original owner, and after prepaid return by the original owner, this Avtech product is found to be defective, Avtech shall at its option repair or replace said defective item. This warranty does not apply to units which have been disassembled, modified or subjected to conditions exceeding the applicable specifications or ratings. This warranty is the extent of the obligation assumed by Avtech with respect to this product and no other warranty or guarantee is either expressed or implied.

TECHNICAL SUPPORT

Phone: 613-226-5772 or 1-800-265-6681

Fax: 613-226-2802 or 1-800-561-1970

E-mail: info@avtechpulse.com

World Wide Web: <http://www.avtechpulse.com>

TABLE OF CONTENTS

WARRANTY.....	2
TECHNICAL SUPPORT.....	2
TABLE OF CONTENTS.....	3
INTRODUCTION.....	5
SPECIFICATIONS.....	6
EC DECLARATION OF CONFORMITY.....	7
INSTALLATION.....	8
VISUAL CHECK.....	8
POWER RATINGS.....	8
CONNECTION TO THE POWER SUPPLY.....	8
ENVIRONMENTAL CONDITIONS.....	8
FUSES.....	9
AC FUSE REPLACEMENT.....	9
DC FUSE REPLACEMENT.....	10
FUSE RATINGS.....	10
FRONT PANEL CONTROLS.....	11
REAR PANEL CONTROLS.....	14
GENERAL INFORMATION.....	15
BASIC PULSE CONTROL.....	15
INTERNAL TRIGGERING.....	15
EXTERNAL TRIGGERING, "EXT B" MODE.....	16
EXTERNAL TRIGGERING, "EXT C" MODE (PWIN=PWOUT).....	17
EXTERNAL TRIGGERING, "EXT A" MODE (VOLTAGE-TO-CURRENT CONVERTER).....	18
MECHANICAL INFORMATION.....	20
TOP COVER REMOVAL.....	20
RACK MOUNTING.....	20
ELECTROMAGNETIC INTERFERENCE.....	20
LOAD PROTECTION.....	21
PROTECTING DIODE LOADS.....	21
NEVER APPLY AN EXTERNAL VOLTAGE TO THE OUTPUT.....	21
LENZ'S LAW AND INDUCTIVE VOLTAGE SPIKES.....	22
ATTACHING AND DETACHING LOADS.....	22
OPEN AND SHORT CIRCUITS.....	22

CONNECTING THE LOAD FOR OPTIMUM PERFORMANCE.....	23
EXAMPLE – ATTACHING A DIODE LOAD.....	24
EXAMPLE – ATTACHING A DIODE LOAD WITH A SERIES RESISTOR.....	25
EXAMPLE – TWO WAYS OF MEASURING CURRENT.....	25
SUGGESTED RESISTORS.....	26
OPERATIONAL CHECK.....	27
CALIBRATION ADJUSTMENTS - INTERNAL TRIMPOTS.....	29
NULLING CONSTANT CURRENT OFFSETS.....	29
NULLING AMPLITUDE-DEPENDENT CURRENT OFFSETS.....	29
NULLING CONSTANT MONITOR OFFSETS.....	29
ADJUSTING OUTPUT IMPEDANCE.....	30
ADJUSTING MONITOR CALIBRATION.....	30
MAINTENANCE.....	31
REGULAR MAINTENANCE.....	31
CLEANING.....	31
PERFORMANCE CHECK SHEET.....	32

Manual Reference: T:\instructword\lav-155\lav-155c-c, edition f.sxw

INTRODUCTION

The Model AV-155C-C pulsed constant current generator is capable of producing pulses with amplitudes as high as ± 2 A into load voltages up to ± 4 V, with 50 ns rise and fall times. A DC offset in the range of 0 to ± 500 mA may be added to the pulse output. (The offset must have the same polarity as the amplitude.)

The internal trigger source can be used to trigger the instrument at frequencies between 10 Hz and 1 MHz. An external TTL trigger pulse or the front-panel pushbutton can also be used to trigger the instrument.

The external trigger function offers considerable flexibility. Several modes are available:

- Voltage-to-current amplifier mode. In this case, the output signal $I_{OUT} \approx V_{AMP} \times 500$ mA/V, and the output current waveform tracks the input voltage waveform. The output follows the input by a minimal fixed delay.
- $PW_{OUT} = PW_{IN}$ mode. The output pulse width tracks the input pulse width, but the amplitude is controlled by the front panel settings. The output follows the input by a minimal fixed delay. The external trigger is TTL-level.
- Normal external trigger mode. The output pulse width and amplitude are controlled by the front panel settings. The output follows the input by a programmable delay. The external trigger is TTL-level.

The Model AV-155C-C pulse generator is a current pulser. The current amplitude is largely independent of the load voltage. For proper operation, the load voltage, where $V_{LOAD} = |I_{LOAD} \times R_{LOAD}|$, must not exceed 4V.

This instrument is intended for use in research and development laboratories.

SPECIFICATIONS

Model:	AV-155C-C ¹
Amplitude ^{3,4} :	
Pulse:	2.0 A
DC offset:	500 mA
Peak:	2.5 A
Pulse width:	100 ns to 1 ms
Pulse repetition frequency (PRF):	0 to 1.0 MHz
Duty cycle (max):	
Internal trigger:	90%
External trigger:	100%
Rise time ⁸ :	≤ 50 ns
Fall time ⁸ :	≤ 50 ns
Polarity:	positive and negative
Output current regulation: (load voltage change from 0 V to 4 V)	≤ 1 %
Load voltage range: (compliance voltage)	0 to 4 Volts
Overshoot ⁸ :	≤ 5%
Jitter: (Ext trig in to pulse out)	< ± 100 ps ± 0.03% of sync delay
Trigger required (Volts, Amps): (Ext trig A mode) ⁵	$I_{OUT} = V_{IN} \times 0.5 \text{ VOLTS/AMP}$
Trigger required: (Ext trig B & C modes) ⁶	TTL, PW > 50 ns
Sync delay:	Variable 0 to 1 ms, sync out to pulse out, Advance or delay
Sync output:	+3 Volts, 50 ns, will drive 50 Ohm loads
Monitor output:	Back-panel SMA connector provides (to 50 Ohm) a coincident replica of the diode current.
Connectors:	
OUT	SMA 50 Ohm cable and AV-LZ1 cable with solder terminals (or optional socket mounting ⁷)
TRIG	BNC
MONITOR	SMA
SYNC	BNC
Power requirement:	115/230 Volts (switchable) 50 - 60 Hz
Dimensions: (H x W x D)	100 mm x 215 mm x 375 mm (3.9" x 8.5" x 14.8")
Chassis material:	anodized aluminum, with blue plastic trim
Mounting:	Any
Temperature range:	+10° to +40°C

- 1) -C suffix indicates stand-alone lab instrument with internal clock and line powering.
- 2) -B suffix indicates IEEE-488.2 GPIB and RS-232 control of amplitude, DC bias, pulse width, PRF and delay. (See page 8).
- 3) For analog electronic control of amplitude or DC offset, suffix the model number with -EA or -EO. Electronic control units also include standard front-panel controls.
- 4) Minimum useful amplitude is 5% of full-scale.
- 5) $R_{in} \geq 500 \Omega$.
- 6) $R_{in} \geq 1k\Omega$.
- 7) To specify socket mounting, add suffix -S5 to the model number and describe the diode package type (e.g. TO-18) and the required pin connections (e.g. anode, cathode, ground, etc.). See page 75 for readily available package mounting. Contact Avtech for special or different packages.
- 8) Valid when using the supplied AV-LZ line to connect to a matched load (i.e., load impedance equals AV-LZ characteristic impedance), at amplitudes greater than 5% of full-scale. Rise and fall times will increase for higher impedance loads, and at amplitudes below 5% of rated maximum. Rise and falls times are measured between 20% and 80% amplitude transition points.

EC DECLARATION OF CONFORMITY

We

Avtech Electrosystems Ltd.
P.O. Box 5120, LCD Merivale
Ottawa, Ontario
Canada K2C 3H4

declare that this pulse generator meets the intent of Directive 89/336/EEC for Electromagnetic Compatibility. Compliance pertains to the following specifications as listed in the official Journal of the European Communities:

EN 50081-1 Emission

EN 50082-1 Immunity

and that this pulse generator meets the intent of the Low Voltage Directive 72/23/EEC as amended by 93/68/EEC. Compliance pertains to the following specifications as listed in the official Journal of the European Communities:

EN 61010-1:2001 Safety requirements for electrical equipment for measurement, control, and laboratory use



INSTALLATION

VISUAL CHECK

After unpacking the instrument, examine to ensure that it has not been damaged in shipment. Visually inspect all connectors, knobs, and handles. Confirm that a power cord, an instrumentation manual (this manual), a 6" RG-174 output cable, and an AV-LZ1 output cable are with the instrument. If the instrument has been damaged, file a claim immediately with the company that transported the instrument.

POWER RATINGS

This instrument is intended to operate from 115 / 230 V \pm 10%, 50-60 Hz. The instrument automatically switches between these two levels. Note, however, that different fuses are required for the two ranges, as described in the "FUSES" section.

The maximum power consumption is 90 Watts. This instrument is an "Installation Category II" instrument, intended for operation from a normal single-phase supply.

CONNECTION TO THE POWER SUPPLY

An IEC-320 three-pronged recessed male socket is provided on the back panel for AC power connection to the instrument. One end of the detachable power cord that is supplied with the instrument plugs into this socket. The other end of the detachable power cord plugs into the local mains supply. Use only the cable supplied with the instrument. The mains supply must be earthed, and the cable used to connect the instrument to the mains supply must provide an earth connection. (The supplied cable does this.)

ENVIRONMENTAL CONDITIONS

This instrument is intended for use under the following conditions:

1. indoor use;
2. altitude up to 2 000 m;
3. temperature 5 °C to 40 °C;
4. maximum relative humidity 80 % for temperatures up to 31 °C decreasing linearly to 50 % relative humidity at 40 °C;
5. Mains supply voltage fluctuations up to \pm 10 % of the nominal voltage;
6. no pollution or only dry, non-conductive pollution.

FUSES

This instrument contains four fuses. All are accessible from the rear-panel. Two protect the AC prime power input, and two protect the internal DC power supplies. The locations of the fuses on the rear panel are shown in the figure below:

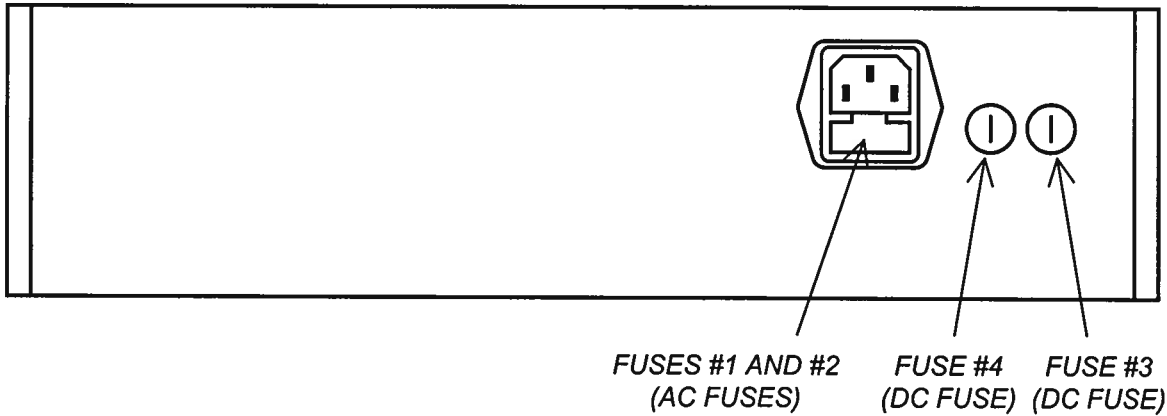

AC FUSE REPLACEMENT

To physically access the AC fuses, the power cord must be detached from the rear panel of the instrument. The fuse drawer may then be extracted using a small flat-head screwdriver, as shown below:

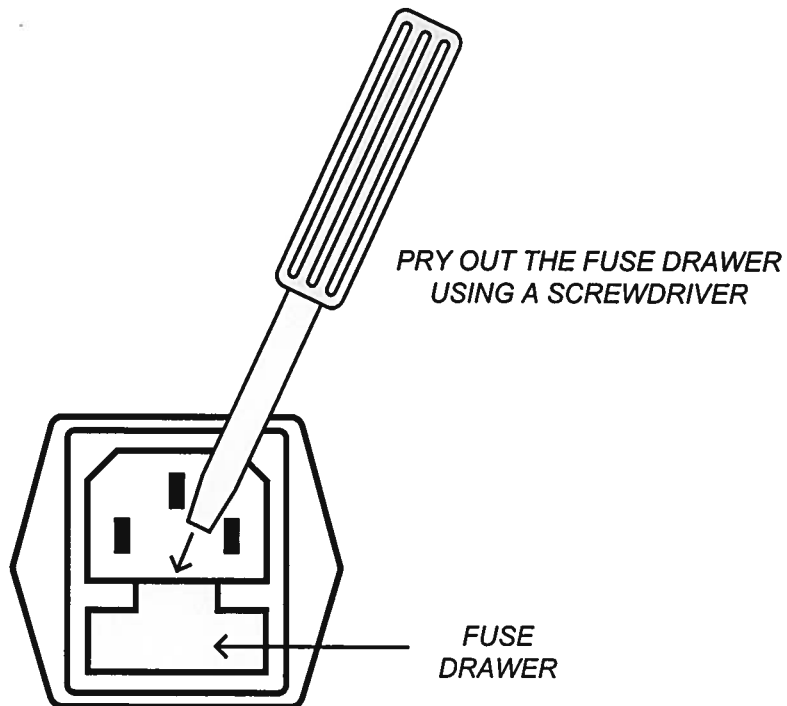

DC FUSE REPLACEMENT

The DC fuses may be replaced by inserting the tip of a flat-head screwdriver into the fuse holder slot, and rotating the slot counter-clockwise. The fuse and its carrier will then pop out.

FUSE RATINGS

The following table lists the required fuses:

Fuses	Mains Voltage	Rating	Case Size	Manufacturer's Part Number (Wickmann)	Distributor's Part Number (Digi-Key)
#1, #2 (AC)	115 V	0.8A, 250V, Time-Delay	5 x 20 mm	1950800000	WK5046-ND
	230 V	0.5A, 250V, Time-Delay	5 x 20 mm	1950500000	WK5041-ND
#3 (DC)	115/230V	3.15A, 250V, Time-Delay	5 x 20 mm	1951315000	WK5124-ND
#4 (DC)	115/230V	3.15A, 250V, Time-Delay	5 x 20 mm	1951315000	WK5124-ND

The fuse manufacturer is Wickmann (<http://www.wickmann.com/>).

Replacement fuses may be easily obtained from Digi-Key (<http://www.digikey.com/>) and other distributors.

FRONT PANEL CONTROLS

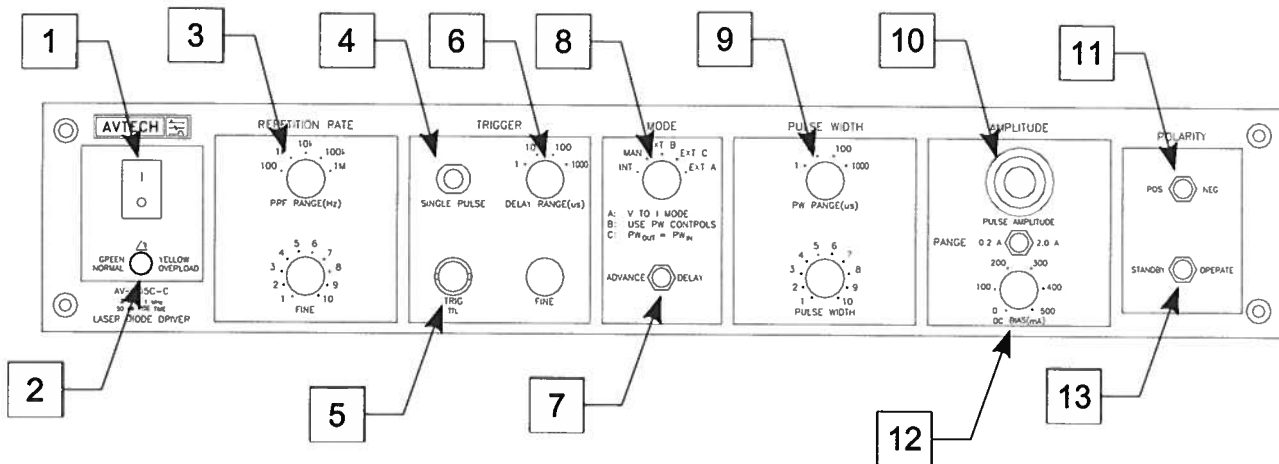

- 1. POWER Switch.** The POWER push button switch applies AC prime power to the primaries of the transformer, turning the instrument on. The push button lamp (#382 type) is connected to the internal +15V DC supply.
- 2. OVERLOAD Indicator.** When the instrument is powered, this indicator is normally green, indicating normal operation. If this indicator is yellow, an internal automatic overload protection circuit has been tripped. If the unit is overloaded (by operating at an exceedingly high duty cycle or by operating into a very low impedance), the protective circuit will disable the output of the instrument and turn the indicator light yellow. The light will stay yellow (i.e. output disabled) for about 5 seconds after which the instrument will attempt to re-enable the output (i.e. light green) for about 1 second. If the overload condition persists, the output will be disabled again (i.e. light yellow) for another 5 seconds. If the overload condition has been removed, the instrument will resume normal operation.

This overload indicator may flash yellow briefly at start-up. This is not a cause for concern.

Note that the output stage will safely withstand a short-circuited load condition.

- 3. REPETITION RATE Controls.** The rotary switch marked "RANGE" selects the pulse repetition rate for the internally triggered mode. The vernier (labeled "FINE") provides continuously variable control of each range. There are five ranges and the instrument is set to the rate indicated on the front panel when the vernier is in the "MAX" position.

10 Hz - 100 Hz
 100 Hz - 1 kHz
 1 kHz - 10 kHz
 10 kHz - 100 kHz

100 kHz - 1.0 MHz

4. SINGLE PULSE Push Button. The "SINGLE PULSE" push button will trigger the instrument manually for one cycle of output, when the "MODE" switch is in the "MAN" position. Otherwise, the push button has no effect.
5. TRIG Connector. When the "MODE" switch is in the "EXT A", "EXT B", or "EXT C" position, this connector is an input. The external trigger is applied to this connector.

When operating in the "INT" mode, this connector is an output. A SYNC output is generated on this connector, to synchronize oscilloscopes or other measurement systems.

6. DELAY Controls. The rotary switch selects one of four ranges, and the vernier provides continuously variable control of each range. The instrument is set to the delay indicated on the front panel when the vernier is in the fully-clockwise position.

100 ns - 1 us
 1 us - 10 us
 10 us - 100 us
 100 us - 1 ms

7. ADVANCE/DELAY Switch. With this switch in the DELAY position, the leading edge of the output pulse precedes the leading edge of the SYNC output. When in the ADVANCE position, the leading edge of the SYNC output precedes the leading edge of the main output.
8. MODE Switch. In the "INT" position the instrument is internally triggered and the TRIG connector provides a SYNC output which allows one to trigger other instruments, such as oscilloscopes.

In the "MAN" a single pulse can be generated by pressing the "SINGLE PULSE" push button. The TRIG connector is not used in this mode.

In the "EXT A" position the instrument acts as a voltage-to-current converter, and the output current (I_{OUT}) is related to the voltage on the TRIG connector (V_{TRIG}) by $I_{OUT} = V_{TRIG} \times 0.5 \text{ Amp/Volt}$.

In the "EXT B" position the instrument is triggered by a TTL-level pulse on the TRIG connector. The output parameters (pulse width, delay, and amplitude) are determined by the front panel settings.

In the "EXT C" position the instrument is triggered by a TTL-level pulse on the TRIG connector. The output pulse occurs with nominally zero delay, and the output pulse width is approximately equal to the input pulse width. The amplitude is controlled by the front panel settings.

9. PULSE WIDTH Controls. The rotary switch selects one of four ranges, and the vernier provides continuously variable control of each range. The instrument is set to the pulse width indicated on the front panel when the vernier is in the fully-clockwise position.

100 ns - 1 us
1 us - 10 us
10 us - 100 us
100 us - 1 ms

10. AMPLITUDE Controls. A two-position switch controls the amplitude full-scale range. The full-scale range may be set to 200 mA or 2 A.

The ten turn amplitude vernier provides continuously variable control of the peak amplitude of the main output from 0 to the full-scale range value, as set by the range switch.

11. POLARITY Switch. This control switches the output polarity (+ or -).

12. DC BIAS (OFFSET) Control. This control varies the output offset, between 0 and 500 mA.

13. STANDBY/OPERATE Switch. When this switch is in the "STANDBY" position, the output is shorted to ground. It is recommended that this mode be used whenever connecting or disconnecting loads, or turning the instrument on or off.

The output operates normally in the "OPERATE" mode.

REAR PANEL CONTROLS

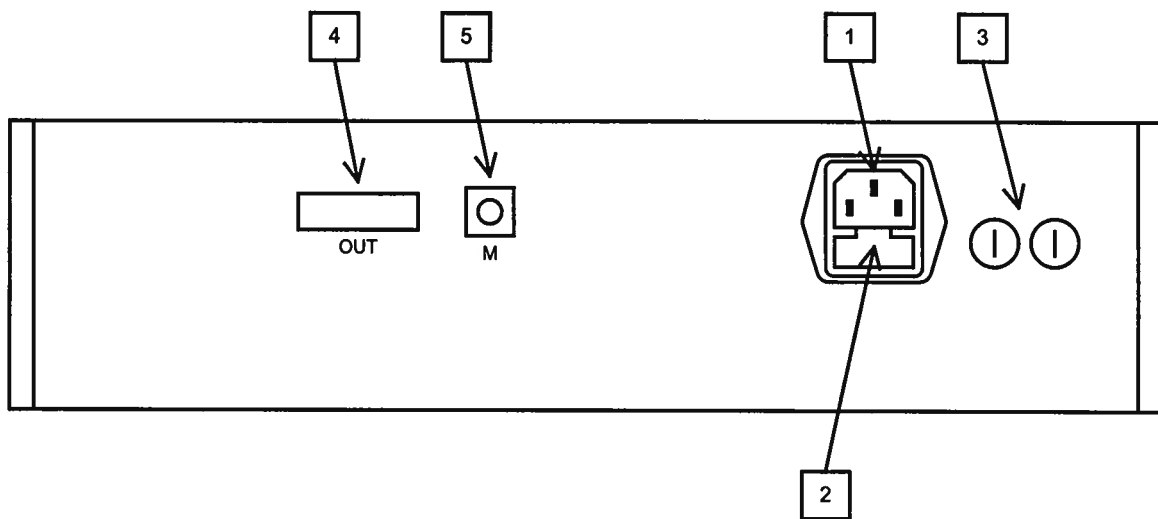

1. **AC POWER INPUT.** An IEC-320 three-pronged recessed male socket is provided on the back panel for AC power connection to the instrument. One end of the detachable power cord that is supplied with the instrument plugs into this socket.
2. **AC FUSE DRAWER.** The two fuses that protect the AC input are located in this drawer. Please see the "FUSES" section of this manual for more information.
3. **DC FUSES.** These two fuses protect the internal DC power supplies. Please see the "FUSES" sections of this manual for more information.
4. **OUT.** This is the main output. The LZ1 transmission line or the RG174 transmission line plugs into this socket. The upper side of the socket ("UP") is the signal line. The lower side ("DOWN") is connected to ground.
5. **MON.** This is a current monitor output. This output provides a voltage waveform that is proportional to the current waveform on the output. The monitor relationship is:

$$V_{\text{MON}} = I_{\text{OUT}} \times 1\Omega, \text{ for a load of } > 1 \text{ k}\Omega. \text{ (The monitor output can also drive a } 50\Omega \text{ load, but the output voltage will be reduced by a factor of 2. This output is short-circuit protected.)}$$

GENERAL INFORMATION

BASIC PULSE CONTROL

This instrument can be triggered by several sources - its own internal clock, an external TTL trigger signal, or by the front-panel "SINGLE PULSE" pushbutton. In any case, three output channels respond to the trigger: OUT, SYNC, and MON. The OUT channel is the signal that is applied to the load. Its amplitude and pulse width are variable. The SYNC pulse is a fixed-width TTL-level reference pulse used to trigger oscilloscopes or other measurement systems. When the delay is set to a positive value the SYNC pulse precedes the OUT pulse. When the delay is set to a negative value the SYNC pulse follows the OUT pulse. The MON output is a voltage waveforms that is proportional to the current waveform on OUT. $V_{MON} = I_{OUT} \times 1\Omega$, for monitor loads of $> 1\text{ k}\Omega$.

The different trigger modes are detailed below. Positive outputs (i.e., generated by a "-P" or "-PN" unit) are shown in the waveform diagrams, but the principles are the same for negative instruments.

INTERNAL TRIGGERING

These pulses are illustrated below for a positive delay, and internal triggering:

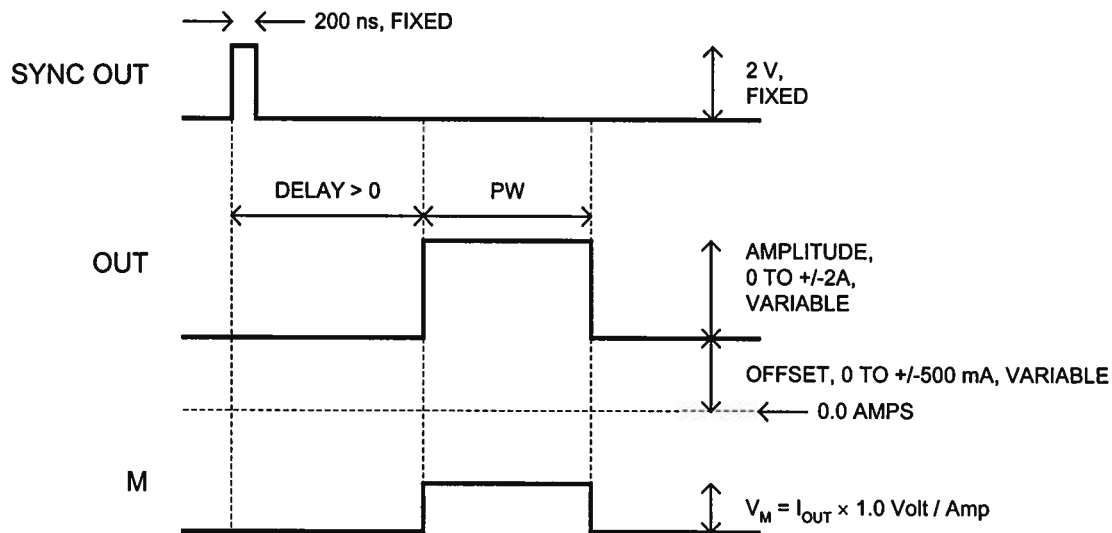

Basic Output Pulses for Delay > 0

The order of the output pulses is reversed for negative delays:

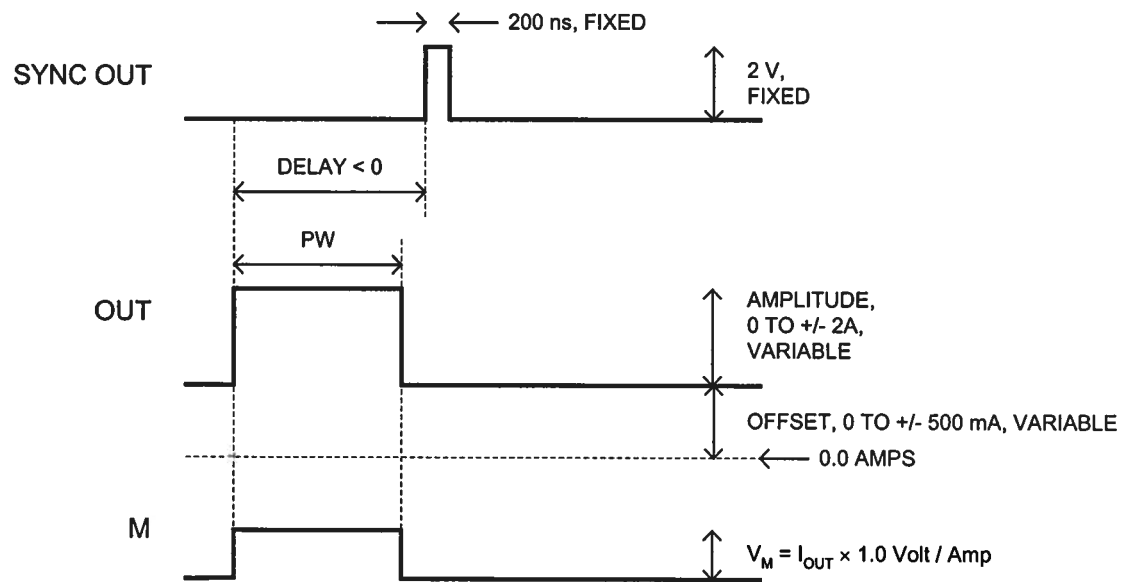

Basic Output Pulses for Delay < 0

The delay, pulse width, amplitude and frequency of the OUT pulse can be varied with front panel controls.

EXTERNAL TRIGGERING, "EXT B" MODE

When the triggering is set to the "EXT B" mode, a TTL-level pulse on the TRIG input will trigger the pulse generator, as shown below:

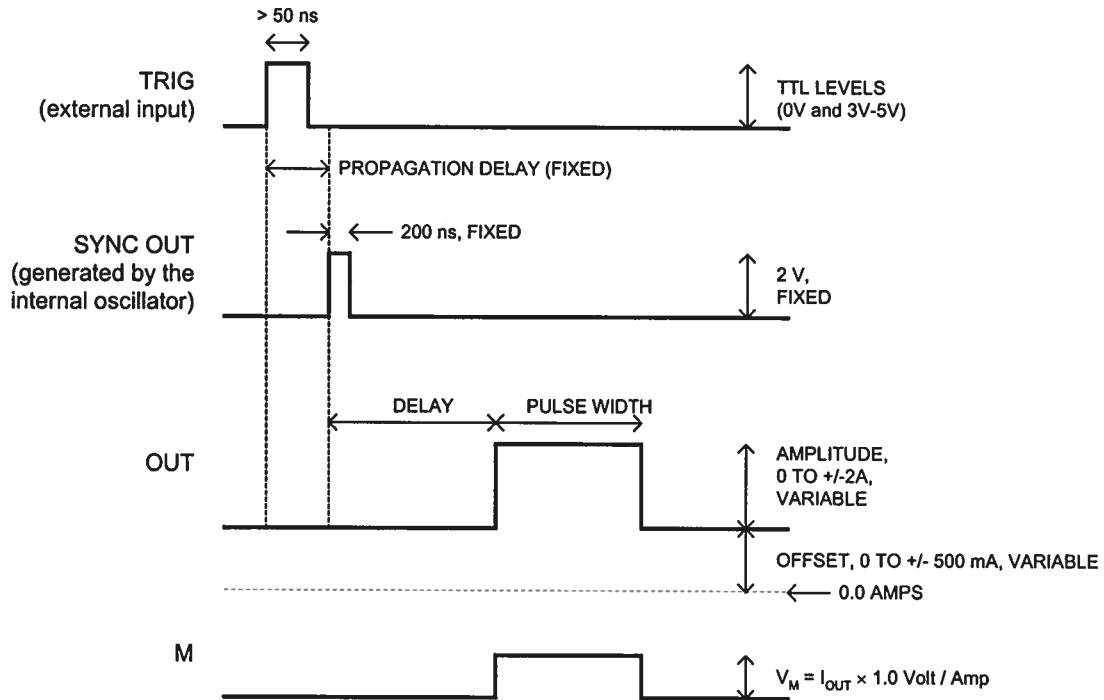

In this mode, the delay, pulse width, and amplitude of the OUT pulse can be varied with front panel controls.

EXTERNAL TRIGGERING. "EXT C" MODE ($PW_{IN}=PW_{OUT}$)

When the triggering is set to "EXT A" mode, a TTL-level pulse on the TRIG input will trigger the pulse generator, as shown below:

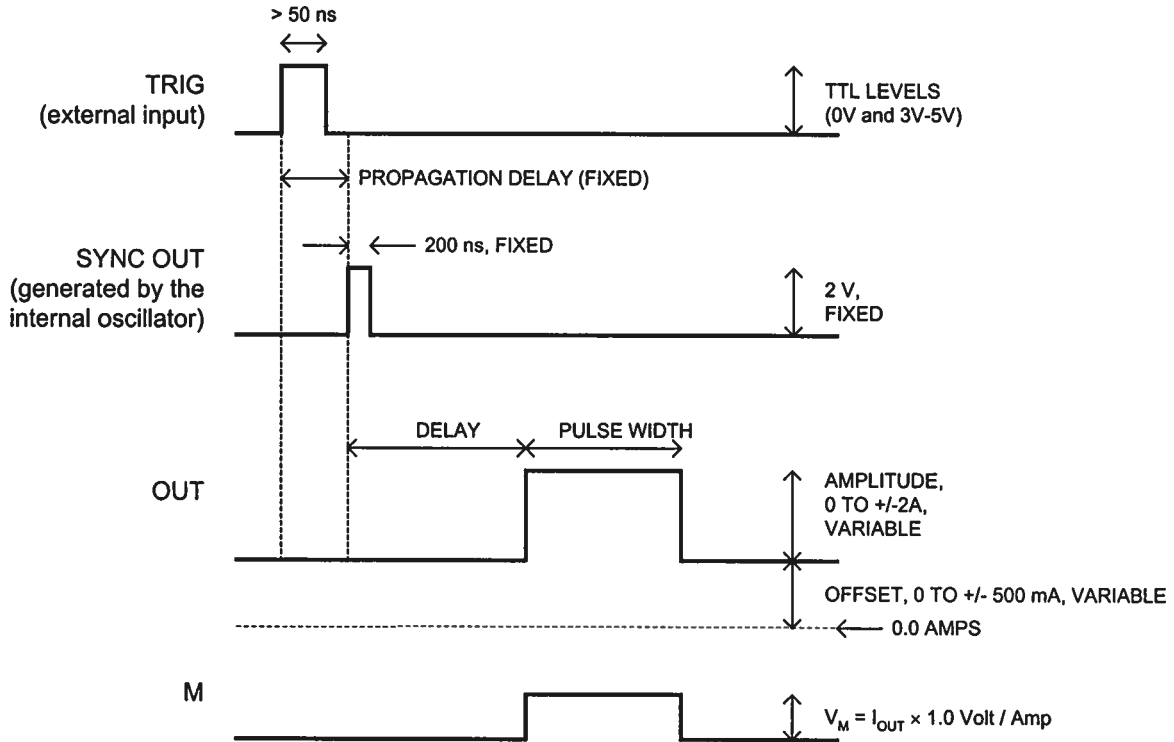

In this mode, the output pulse width is approximately equal to the pulse width of the TTL-level trigger pulse on the TRIG input. The output pulse is generated after a short propagation delay. The delay is not variable. The amplitude of the OUT pulse can be varied with front panel controls.

EXTERNAL TRIGGERING, "EXT A" MODE (VOLTAGE-TO-CURRENT CONVERTER)

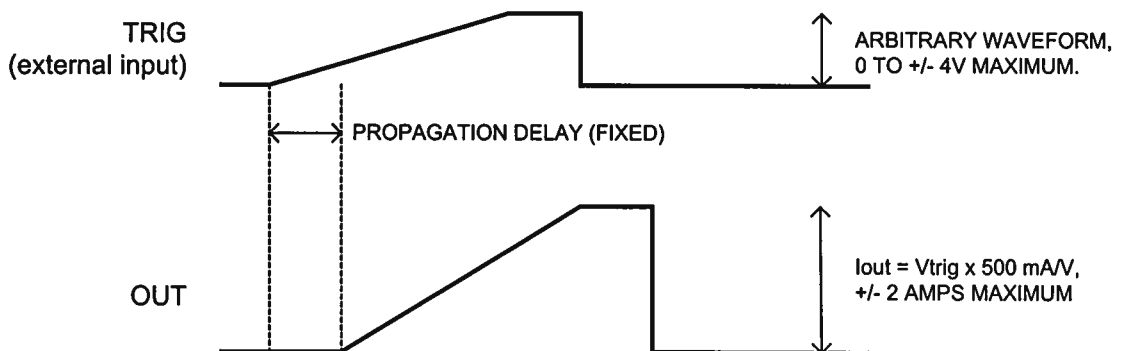

When the triggering is set to "EXT A" mode, the instrument acts as a fixed-gain voltage-to-current amplifier, and the output current is: $I_{OUT} = V_{AMP} \times 500$ mA/V, where V_{AMP} is the voltage waveform on the AMP connector. This is illustrated below:





In this mode, the output pulse width and amplitude are determined by the signal on the AMP connector. The SYNC output is not useful in this mode.

The input in this mode is always positive, regardless of whether the instrument is positive, negative, or dual-polarity.



MECHANICAL INFORMATION

TOP COVER REMOVAL

If necessary, the interior of the instrument may be accessed by removing the four Phillips screws on the top panel. With the four screws removed, the top cover may be slid back (and off).

Always disconnect the power cord before opening the instrument.

There are no user-adjustable internal circuits. For repairs other than fuse replacement, please contact Avtech (info@avtechpulse.com) to arrange for the instrument to be returned to the factory for repair.

 Caution: High voltages are present inside the instrument during normal operation. Do not operate the instrument with the cover removed.

RACK MOUNTING

A rack mounting kit is available. The -R5 rack mount kit may be installed after first removing the one Phillips screw on the side panel adjacent to the front handle.

ELECTROMAGNETIC INTERFERENCE

To prevent electromagnetic interference with other equipment, all used outputs should be connected to shielded 50Ω loads using shielded 50Ω coaxial cables. Unused outputs should be terminated with shielded 50Ω BNC terminators or with shielded BNC dust caps, to prevent unintentional electromagnetic radiation. All cords and cables should be less than 3m in length.

LOAD PROTECTION

PROTECTING DIODE LOADS

It is possible for a small offset current to be generated on the output, if the trimpots (see the "Calibration Adjustments" section) are not correctly adjusted. This can lead to the development of a negative voltage on a diode load. If the diode breakdown voltage is less than 15V, breakdown can occur. If your load is sensitive to this, the load should be protected by adding a low-capacitance shunt Schottky diode, as illustrated below:

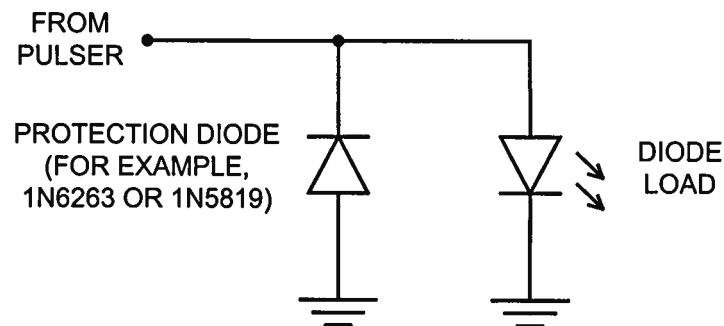

The previous diagram assumes that the diode is to be driven with a positive current. This circuit will prevent the output voltage going below approximately -0.5V.

The equivalent circuit for negative output currents is shown below:

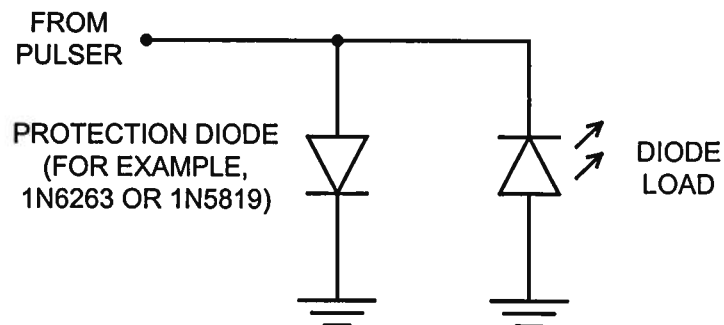

NEVER APPLY AN EXTERNAL VOLTAGE TO THE OUTPUT

Externally generated potentials must never be applied to the output.

LENZ'S LAW AND INDUCTIVE VOLTAGE SPIKES

This instrument is designed to pulse resistive and diode loads and will exhibit a large output spike when used to drive a load with significant inductance (as predicted by LENZ'S LAW). For this reason the load should be connected to the output using low inductance leads (as short as possible and as heavy a gauge as possible).

The voltage developed across an inductance L (in Henries), when the current is changing at a rate given by di_{LOAD} / dt (in Amps/sec), is: $V_{SPIKE} = L di_{LOAD} / dt$.

ATTACHING AND DETACHING LOADS

To avoid damaging the loads connected to main outputs, the loads should only be connected to or removed from the instrument when:

- the instrument is off
- the instrument is on, but the "STANDBY/OPERATE" switch is in the STANDBY position.

Do not connect loads when the instrument is on and the outputs are turned on. This can cause sparking.

CHANGING PARAMETERS WHEN A LOAD IS ATTACHED

If your load is easily damaged, reduce the amplitude and offset settings to zero, and switch the instrument to STANDBY mode before changing the timing parameters, especially if you need to change a timing range setting. This protects the loads from possible short transient effects.

OPEN AND SHORT CIRCUITS

The AV-155C-C will operate properly into a short circuit to ground. Operation into an open circuit will not damage the instrument in any way.

CONNECTING THE LOAD FOR OPTIMUM PERFORMANCE

This instrument is supplied with two types of output cables, which can be plugged in the the OUT socket on the rear panel:

- The LZ1 flexible flat transmission line, which has a 1Ω characteristic impedance (Z_0).
- A 6" RG174 coaxial transmission line, which has a 50Ω characteristic impedance (Z_0).

For both cables, the end that plugs into the rear panel is marked with an "UP" side and a "DOWN" side. (The UP side is the signal output, and the DOWN side is ground.)

The LZ1 transmission line is terminated with a small circuit board, as shown below:

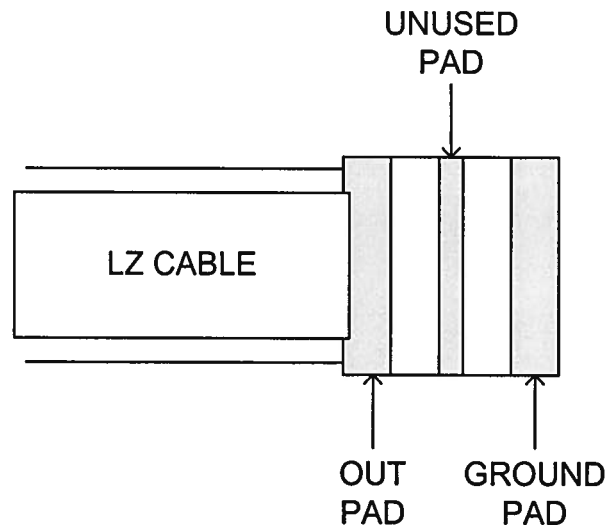

To obtain the very best waveform, it is important that the characteristic impedance of the transmission line used to connect the load to the pulser be well matched to the load impedance. This will minimize transmission line reflections.

Thus, when connecting to a low-impedance load, like a laser diode, the LZ1 line will provide the best performance. However, the LZ1 line may be physically awkward to use. If increased rise time or waveform ringing can be tolerated, the 6" length of RG-174 cable may be used instead.

For more information regarding connection methods, see "Technical Brief No. 1 - How to Connect Loads to your Pulsed Constant Current Generator for Optimum Performance", online at <http://www.avtechpulse.com/appnote>.

EXAMPLE – ATTACHING A DIODE LOAD

The two photos below show a laser diode soldered between the top-side out pad and the bottom-side ground plane:

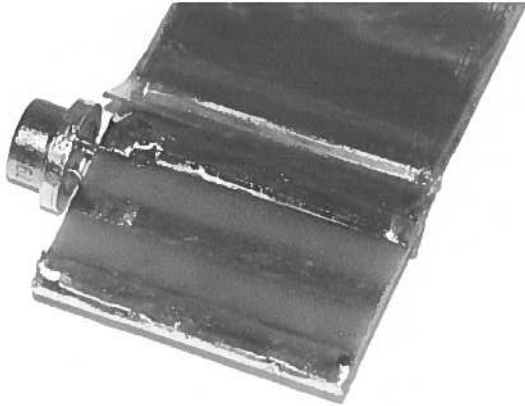

Top View – The diode anode is soldered to the OUT pad.

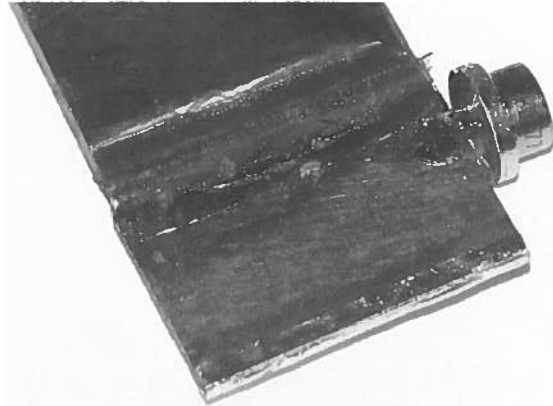

Bottom View – The diode cathode is soldered to the ground plane.

The arrangement shown above will produce best results if the resistance of the diode is approximately equal to the characteristic impedance of the transmission line. If the diode resistance is lower, then a series resistor should be installed. This is illustrated in the next section.

For maximum performance, the lead lengths are as short as possible. The photo below, in contrast, shows the wrong way to connect a diode load:

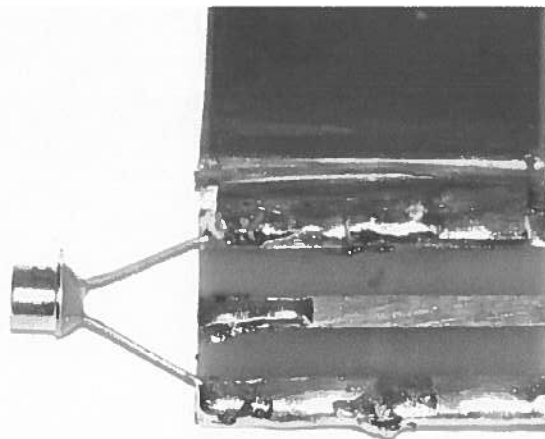

Wrong Way To Connect a Diode. The leads are too long!

In the above photo, approximately 1 inch of lead length is present in the circuit. The inductance of such leads is approximately 10 nH / inch. This may add significant distortion to the waveform, which can be estimated using Lenz's Law ($V = L \, di/dt$). See the "LENZ'S LAW AND INDUCTIVE VOLTAGE SPIKES" section for more details.

EXAMPLE – ATTACHING A DIODE LOAD WITH A SERIES RESISTOR

As noted above, it may be desirable to add a resistance in series with a diode load. (This is required on voltage pulsers, but optional on current pulsers.) This can be conveniently implemented by using the unconnected middle pad as a connection point, as shown in the photo below:

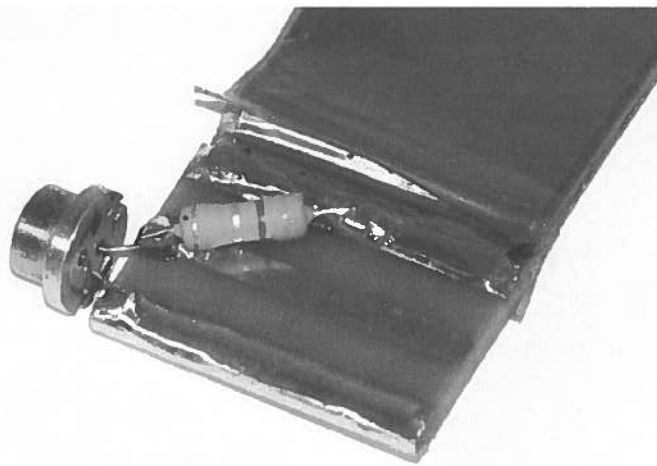

In this set-up, one end of the resistor has been soldered to the OUT pad. The other end is soldered to the anode of the diode. The diode cathode is soldered to ground.

See the "SUGGESTED RESISTORS" section for more about appropriate resistors.

EXAMPLE – TWO WAYS OF MEASURING CURRENT

The photo below shows a resistive load installed between the top-side OUT and GND pads. Also, two methods of measuring the current are shown.

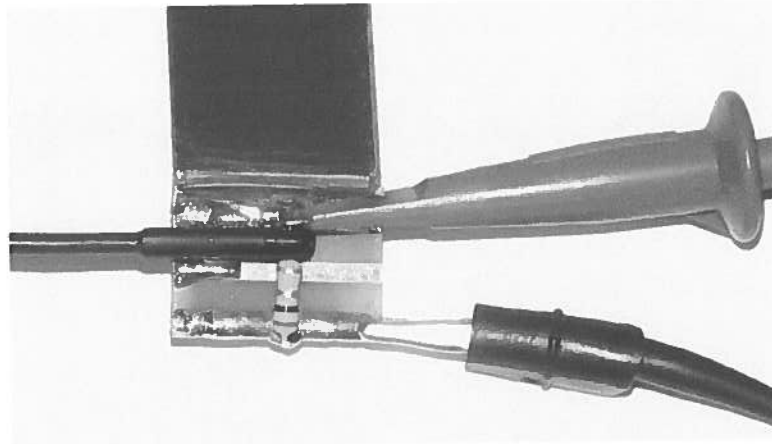

On the right side of the photo, an oscilloscope probe (and ground clip) are connected across the resistor. The current waveform can be calculated from the observed voltage waveform using Ohm's Law. However, the parasitic inductance of the resistor can distort the waveform slightly. For some applications, a current probe may yield better measurements.

On the left side of the photo, an Integrated Sensor Technologies (<http://www.isensortech.com/>) model 711 current probe is shown. A short length of the resistor lead has been fed through the donut-shaped probe. The other end of the probe is connected to an oscilloscope. The waveform observed on the oscilloscope is proportional to the current measured by the probe.

SUGGESTED RESISTORS

Avtech recommends two types of resistors for use in medium-current pulsed applications.

The RCD RSF1A and RSF2B series of low-inductance 1W and 2W resistors are well-suited for low-to-medium current applications. They are available with resistances as low as 0.1 Ohms. The RSF1A is relatively small, physically. See <http://www.rcd-comp.com/> for more information.

The Ohmite OX and OY series of low-inductance 1W and 2W resistors are well-suited for medium-to-high current applications. They are extremely rugged, and are less prone to fail when abused, compared to the RSF1A and RSF2B series. However, they are larger in size. See <http://www.ohmite.com/> for more information. These resistors are readily available from Digi-Key (<http://www.digikey.com/>).

It is generally advisable to connect several resistors in parallel to achieve a low resistance, because this has the added benefit of also lowering the total effective inductance.

OPERATIONAL CHECK

This section describes a sequence to confirm the basic operation of the instrument. It should be performed after receiving the instrument. It is a useful learning exercise as well.

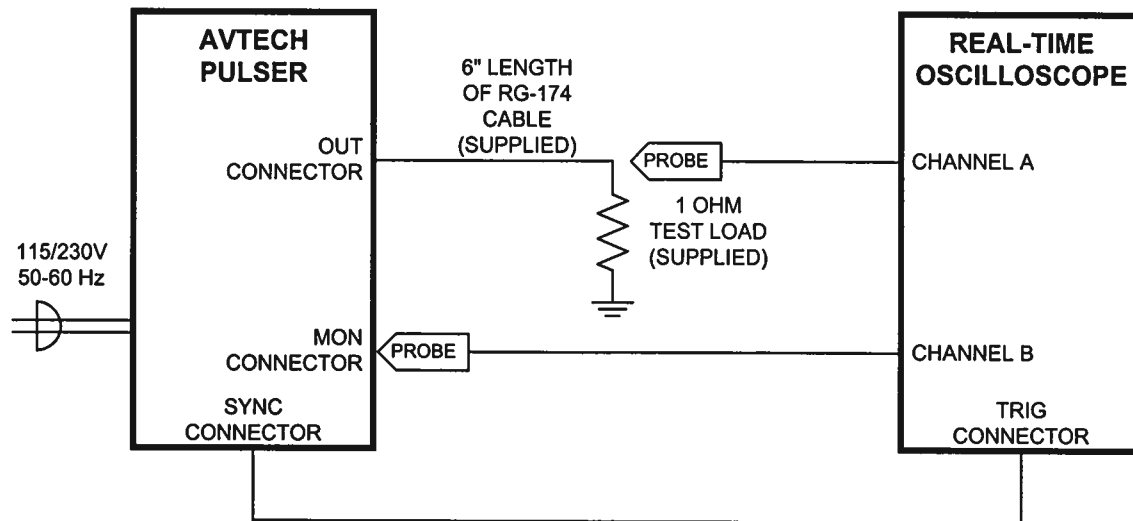

Basic Test Arrangement

- 1) Insert the card-end of the supplied RG-174 cable into the rear-panel "OUT" slot connector of the AV-155C-C. Attached the supplied connectorized 1 Ohm test load to the other end of the RG-174 cable.
- 2) Connect a cable from the TRIG connector to the TRIG input of an oscilloscope. Set the oscilloscope to trigger externally.
- 3) Connect one oscilloscope probe (channel A) to the signal side of the test load. Connect the other probe to the MON output (on the rear panel). On the oscilloscope, set the channel A vertical scale to 1 V/div, the channel B vertical scale to 1 V/div, and the horizontal scale to 200 ns/div.
- 4) Turn on the AV-155C-C.
- 5) To set the AV-155C-C to trigger from the internal clock at a PRF of 10 kHz, set the repetition frequency range switch to 10 kHz, and rotate the FINE vernier control fully clockwise.
- 6) To set the OUT pulse width to 500 ns, set the pulse width range switch to 1 us, and rotate the FINE vernier control to halfway between minimum and maximum.

- 7) At this point, nothing should appear on the oscilloscope.
- 8) Switch the STANDBY/OPERATE switch to "OPERATE".
- 9) Switch the amplitude range switch to "2A". Rotate the amplitude vernier to its maximum setting.
- 10) Set the offset control fully counter-clockwise.
- 11) On the oscilloscope, you should see pulses with 2V of amplitude (i.e., $2A \times 1\Omega$), approximately 500 ns pulse width, and 10 kHz repetition rate. Some distortion may be observed on the leading and falling edges, due to the use of the non-optimal RG-174 cable.
- 12) This completes the operational check.

If additional assistance is required:

Tel: (613) 226-5772,
Fax: (613) 226-2802
Email: info@avtechpulse.com

CALIBRATION ADJUSTMENTS - INTERNAL TRIMPOTS

The output module has five trimming potentiometers ("trimpots") that can be used to adjust the performance of the output. These trimpots are preset at the factory and should not normally require adjusting after delivery. These controls can be accessed by removing the top panel of the instrument, and by locating the output-stage module. It is near the rear of the instrument.

The locations of the trimpots (designated TP1-TP5) are shown below. All should be accessible through any heatsinking.

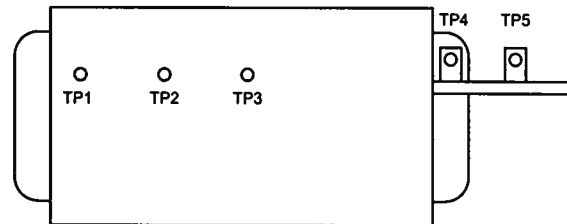

Location of Trimpots

These trimpots can be used to adjust or calibrate the followings properties:

- Current offsets on the main outputs.
- Voltage offsets on the monitor outputs.
- Monitor calibration.
- Output impedance.

NULLING CONSTANT CURRENT OFFSETS

If a small constant current offset is observed on one of the main outputs, TP2 can be rotated to reduce it to zero.

NULLING AMPLITUDE-DEPENDENT CURRENT OFFSETS

If a small amplitude-dependent current offset is observed on one of the main outputs, TP1 can be rotated to null it out. Rotate TP1 while adjusting the output amplitude from the front panel, until the offset does not vary with amplitude.

NULLING CONSTANT MONITOR OFFSETS

If a small constant voltage offset is observed on one of the monitor outputs, TP5 can be rotated to reduce it to zero.

ADJUSTING OUTPUT IMPEDANCE

Ideally, the outputs of the pulsed current sources should be independent of the output voltages, within the 0 to $\pm 4\text{V}$ compliance voltage range. This condition represents infinite output impedance. If a load voltage/output current dependence is present, the output impedance needs to be adjusted.

To adjust the output impedance, connect a 1Ω load to the output to be adjusted. Set the output amplitude to 2A and observe the load voltage on an oscilloscope. The load voltage should have an amplitude of approximately 2V (i.e. $2\text{A} \times 1\Omega = 2\text{V}$). Note the exact value. Now replace the 1Ω load with a 0.5Ω load. The load voltage should fall by to approximately 1V (i.e. $2\text{A} \times 0.5\Omega = 1\text{V}$). Note the exact value. If the second voltage is not exactly one-half of the first voltage, adjust TP3 and repeat *both* measurements (1Ω and 0.5Ω) again. Repeat as required.

ADJUSTING MONITOR CALIBRATION

Just as the current amplitude of the main outputs can exhibit a load-voltage dependence, the voltage amplitude of the current monitors can also exhibit such a dependence if not adjusted properly.

To null out the monitor load voltage dependence, connect a 1Ω load to the main output. Set the output amplitude to 2A and observe the monitor voltage on an oscilloscope. The monitor voltage should have an amplitude of approximately 2V. Note the exact value. Now replace the 1Ω load with a 0.5Ω load. The monitor voltage should not change, since the current amplitude has not changed. Note the exact value. If the second voltage is not exactly equal to the first voltage, adjust TP4 and repeat *both* measurements (1Ω and 0.5Ω) again. Repeat as required.

MAINTENANCE

REGULAR MAINTENANCE

This instrument does not require any regular maintenance.

On occasion, one or more of the four rear-panel fuses may require replacement. All fuses can be accessed from the rear panel. See the "FUSES" section for details.

CLEANING

If desired, the interior of the instrument may be cleaned using compressed air to dislodge any accumulated dust. (See the "TOP COVER REMOVAL" section for instructions on accessing the interior.) No other cleaning is recommended.

May 1, 2003