



AVTECH ELECTROSYSTEMS LTD.

NANOSECOND WAVEFORM ELECTRONICS
SINCE 1975

P.O. BOX 265
OGDENSBURG, NY
U.S.A. 13669-0265

TEL: 888-670-8729 (USA & Canada) or +1-613-226-5772 (Intl)
FAX: 800-561-1970 (USA & Canada) or +1-613-226-2802 (Intl)

info@avtechpulse.com - <http://www.avtechpulse.com/>

BOX 5120, LCD MERIVALE
OTTAWA, ONTARIO
CANADA K2C 3H4

INSTRUCTIONS

MODEL AVB2-TE-C

0 TO 200 VOLTS (PEAK-TO-PEAK),

10-100 MHz CENTER FREQUENCY

MONOCYCLE GENERATOR

SERIAL NUMBER: _____

WARRANTY

Avtech Electrosystems Ltd. warrants products of its manufacture to be free from defects in material and workmanship under conditions of normal use. If, within one year after delivery to the original owner, and after prepaid return by the original owner, this Avtech product is found to be defective, Avtech shall at its option repair or replace said defective item. This warranty does not apply to units which have been disassembled, modified or subjected to conditions exceeding the applicable specifications or ratings. This warranty is the extent of the obligation assumed by Avtech with respect to this product and no other warranty or guarantee is either expressed or implied.

TECHNICAL SUPPORT

Phone: 888-670-8729 (USA & Canada) or +1-613-226-5772 (Intl)

Fax: 800-561-1970 (USA & Canada) or +1-613-226-2802 (Intl)

E-mail: info@avtechpulse.com

World Wide Web: <http://www.avtechpulse.com>

TABLE OF CONTENTS

WARRANTY.....	2
TECHNICAL SUPPORT.....	2
TABLE OF CONTENTS.....	3
INTRODUCTION.....	5
AVAILABLE OPTIONS.....	6
HIGH-VOLTAGE PRECAUTIONS.....	6
SPECIFICATIONS.....	7
EUROPEAN REGULATORY NOTES.....	8
EC DECLARATION OF CONFORMITY.....	8
DIRECTIVE 2002/95/EC (RoHS).....	8
DIRECTIVE 2002/96/EC (WEEE).....	8
INSTALLATION.....	10
VISUAL CHECK.....	10
POWER RATINGS.....	10
CONNECTION TO THE POWER SUPPLY.....	10
PROTECTION FROM ELECTRIC SHOCK.....	11
ENVIRONMENTAL CONDITIONS.....	11
FUSES.....	13
AC FUSE REPLACEMENT.....	13
DC FUSE REPLACEMENT.....	14
FUSE RATINGS.....	14
FRONT PANEL CONTROLS.....	15
REAR PANEL CONTROLS.....	17
GENERAL INFORMATION.....	18
BASIC TEST ARRANGEMENT.....	18
BASIC PULSE CONTROL.....	18
-PN OPTION.....	20
-PI OPTION.....	20
MINIMIZING WAVEFORM DISTORTIONS.....	21
USE 50Ω TRANSMISSION LINES AND LOADS.....	21
USE LOW-INDUCTANCE LOADS.....	21
PROTECTING YOUR INSTRUMENT.....	22

TURN OFF INSTRUMENT WHEN NOT IN USE.....	22
DO NOT EXCEED 10 kHz.....	22
USE A 50 OHM LOAD.....	22
MECHANICAL INFORMATION.....	23
TOP COVER REMOVAL.....	23
RACK MOUNTING.....	23
ELECTROMAGNETIC INTERFERENCE.....	23
MAINTENANCE.....	24
REGULAR MAINTENANCE.....	24
CLEANING.....	24
PERFORMANCE CHECKSHEET.....	25

Manual Reference: T:\instructword\avb\AVB2-TE-C,edition2.odt.
Last modified October 11, 2006.
Copyright © 2006 Avtech Electrosystems Ltd, All Rights Reserved.

INTRODUCTION

The AVB2-TE-C is a high performance monocycle generator. The output amplitude is variable up to 200 Volts peak-to-peak into 50 Ω (falling to 150 V_{P-P} above 80 MHz). The center frequency of the output may be varied from 10 to 100 MHz. The repetition frequency is variable from 1 Hz to 10 kHz.

On standard models, the positive portion of the monocycle precedes the negative portion. The -PN option allows this to be order to be reversed, using a front-panel switch. The -PI option also includes this polarity reversal mode, and adds an additional mode where polarity phase of every second monocycle is reversed. That is, the monocycle polarity alternates as +/-, -/+, +/-, -/+, etc. This is particularly useful for pulse inversion Doppler imaging applications.

The output is designed to drive 50 Ω loads. (A 50 Ω load is required for proper operation.) The output is AC-coupled.

This instrument is intended for use in research, development, test and calibration laboratories by qualified personnel.

AVAILABLE OPTIONS

-EA Option: the amplitude can be controlled by an externally generated 0 to +10V analog control voltage.

-PN Option: On standard models, the positive portion of the monocycle precedes the negative portion. The -PN option allows this to be order to be reversed.

-PI Option: The -PI option includes the “-PN” option, and adds an additional mode where polarity phase of every second monocycle is reversed. That is, the monocycle polarity alternates as +/-, -/+, +/-, -/+, etc. This is particularly useful for pulse inversion Doppler imaging applications.

-R5 Option: This is the optional rack-mounting kit. The R5 rack-mount kit may also be ordered separately.

HIGH-VOLTAGE PRECAUTIONS

 **CAUTION:** This instrument provides output voltages as high as ± 100 Volts, so extreme caution must be employed when using this instrument. The instrument should only be used by individuals who are thoroughly skilled in high voltage laboratory techniques. The following precaution should always be observed:

1. Keep exposed high-voltage wiring to an absolute minimum.
2. Wherever possible, use shielded connectors and cabling.
3. Connect and disconnect loads and cables only when the amplifier is turned off.
4. Keep in mind that all cables, connectors, oscilloscope probes, and loads must have an appropriate voltage rating.
5. Do not attempt any repairs on the instrument, beyond the fuse replacement procedures described in this manual. Contact Avtech technical support (see page 2 for contact information) if the instrument requires servicing.

SPECIFICATIONS

Model:	AVB2-TE-C ¹
Center Freq. Range (MHz):	10-100
Center Freq. Tuning:	Tunes full range, using a front-panel one-turn control ³ .
Amplitude ^{3,4} : (into 50 Ohms)	0 to 200 Volts ⁷ , peak-to-peak
Max. pulse repetition rate:	10 kHz
Spurious signals:	26 dB (WRT peak)
Phase / Polarity:	Standard units: Positive portion leads, negative portion lags. Not adjustable. With -PN option: Positive or negative leads, switchable. With -PI option: Positive or negative leads, switchable. Also, the the unit may be set to invert the polarity phase for every second trigger (e.g., for pulse inversion Doppler imaging applications).
Propagation delay:	≤ 300 ns (Ext trig in to pulse out)
Jitter:	± 35ps ± 0.015% of sync delay (Ext trig in to pulse out)
Trigger required:	Ext trig mode: +5 Volts, 50 to 500 ns (TTL)
Sync delay:	Sync out to pulse out: Variable 0 to 200 ns
Sync output:	+ 3 Volts, 200 ns (100 ns for -B units), will drive 50 Ohm loads
Connectors:	Out, Trig/Sync: BNC
Power requirements:	100 - 240 Volts, 50 - 60 Hz
Dimensions (H x W x D):	100 mm x 430 mm x 375 mm (3.9" x 17" x 14.8")
Chassis material:	Anodized aluminum, with blue plastic trim.
Mounting:	Bench-top use. Add -R5 option for rack-mount kit.
Temperature range:	+5°C to +40°C

- 1) -C suffix indicates stand-alone lab instrument with internal clock and line powering. (See <http://www.avtechpulse.com/formats> for additional details of the basic instrument formats).
- 2) -B suffix indicates IEEE-488.2 GPIB and RS-232 control of amplitude, pulse width, PRF and delay (See <http://www.avtechpulse.com/gpib>).
- 3) For electronic control (0 to +10V) of amplitude or frequency suffix the model number with -EA or -EF. (The -EF option is not available on -B units). Electronic control units also include the standard front-panel controls.
- 4) For operation at amplitudes of less than 10% of full-scale, best results will be obtained by setting the amplitude near full-scale and using external attenuators on the output.
- 5) Add the suffix -TNT to the model number to specify the Telnet / Ethernet control option.
- 6) Specify desired output connector at time of ordering by adding the suffix -SHV, -MHV, or -NC. If unspecified, it will be supplied with SHV connectors.
- 7) Falls to 150V peak-to-peak for center frequencies above 80 MHz.

EUROPEAN REGULATORY NOTES

EC DECLARATION OF CONFORMITY

We Avtech Electrosystems Ltd.
P.O. Box 5120, LCD Merivale
Ottawa, Ontario
Canada K2C 3H4

declare that this pulse generator meets the intent of Directive 89/336/EEC for Electromagnetic Compatibility. Compliance pertains to the following specifications as listed in the official Journal of the European Communities:

EN 50081-1 Emission

EN 50082-1 Immunity

and that this pulse generator meets the intent of the Low Voltage Directive 72/23/EEC as amended by 93/68/EEC. Compliance pertains to the following specifications as listed in the official Journal of the European Communities:

EN 61010-1:2001 Safety requirements for electrical equipment for measurement, control, and laboratory use



DIRECTIVE 2002/95/EC (RoHS)

This instrument is exempt from Directive 2002/95/EC of the European Parliament and of the Council of 27 January 2003 on the Restriction of the use of certain Hazardous Substances (RoHS) in electrical and electronic equipment. Specifically, Avtech instruments are considered "Monitoring and control instruments" (Category 9) as defined in Annex 1A of Directive 2002/96/EC. The Directive 2002/95/EC only applies to Directive 2002/96/EC categories 1-7 and 10, as stated in the "Article 2 - Scope" section of Directive 2002/95/EC.

DIRECTIVE 2002/96/EC (WEEE)

European customers who have purchased this equipment directly from Avtech will have completed a "WEEE Responsibility Agreement" form, accepting responsibility for

WEEE compliance (as mandated in Directive 2002/96/EC of the European Union and local laws) on behalf of the customer, as provided for under Article 9 of Directive 2002/96/EC.

Customers who have purchased Avtech equipment through local representatives should consult with the representative to determine who has responsibility for WEEE compliance. Normally, such responsibilities will lie with the representative, unless other arrangements (under Article 9) have been made.

Requirements for WEEE compliance may include registration of products with local governments, reporting of recycling activities to local governments, and financing of recycling activities.

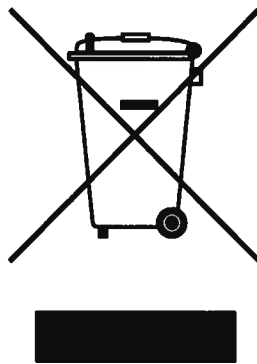

INSTALLATION

VISUAL CHECK

After unpacking the instrument, examine to ensure that it has not been damaged in shipment. Visually inspect all connectors, knobs, and handles. Confirm that a power cord is with the instrument. If the instrument has been damaged, file a claim immediately with the company that transported the instrument.

POWER RATINGS

This instrument is intended to operate from 100 - 240 V, 50 - 60 Hz.

The maximum power consumption is 57 Watts. Please see the "FUSES" section for information about the appropriate AC and DC fuses.

This instrument is an "Installation Category II" instrument, intended for operation from a normal single-phase supply.

CONNECTION TO THE POWER SUPPLY

An IEC-320 three-pronged recessed male socket is provided on the back panel for AC power connection to the instrument. One end of the detachable power cord that is supplied with the instrument plugs into this socket. The other end of the detachable power cord plugs into the local mains supply. Use only the cable supplied with the instrument. The mains supply must be earthed, and the cord used to connect the instrument to the mains supply must provide an earth connection. (The supplied cord does this.)

 **Warning:** Failure to use a grounded outlet may result in injury or death due to electric shock. This product uses a power cord with a ground connection. It must be connected to a properly grounded outlet. The instrument chassis is connected to the ground wire in the power cord.

The table below describes the power cord that is normally supplied with this instrument, depending on the destination region:

Destination Region	Description	Manufacturer	Part Number
Continental Europe	European CEE 7/7 "Schuko" 230V, 50Hz	Volex (http://www.volex.com)	17850-C3-326
		Qualtek (http://www.qualtekusa.com)	319004-T01
United Kingdom	BS 1363, 230V, 50Hz	Qualtek (http://www.qualtekusa.com)	370001-E01
Switzerland	SEV 1011, 2 30V, 50Hz	Volex (http://www.volex.com)	2102H-C3-10
Israel	SI 32, 220V, 50Hz	Volex (http://www.volex.com)	2115H-C3-10
North America, and all other areas	NEMA 5-15, 120V, 60 Hz	Qualtek (http://www.qualtekusa.com)	312007-01

PROTECTION FROM ELECTRIC SHOCK

 Operators of this instrument must be protected from electric shock at all times. The owner must ensure that operators are prevented access and/or are insulated from every connection point. In some cases, connections must be exposed to potential human contact. Operators must be trained to protect themselves from the risk of electric shock. This instrument is intended for use by qualified personnel who recognize shock hazards and are familiar with safety precautions required to avoid possibly injury. In particular, operators should:

1. Keep exposed high-voltage wiring to an absolute minimum.
2. Wherever possible, use shielded connectors and cabling.
3. Connect and disconnect loads and cables only when the instrument is turned off.
4. Keep in mind that all cables, connectors, oscilloscope probes, and loads must have an appropriate voltage rating.
5. Do not attempt any repairs on the instrument, beyond the fuse replacement procedures described in this manual. Contact Avtech technical support (see page 2 for contact information) if the instrument requires servicing. Service is to be performed solely by qualified service personnel.

ENVIRONMENTAL CONDITIONS

This instrument is intended for use under the following conditions:

1. indoor use;
2. altitude up to 2 000 m;
3. temperature 5 °C to 40 °C;

4. maximum relative humidity 80 % for temperatures up to 31 °C decreasing linearly to 50 % relative humidity at 40 °C;
5. Mains supply voltage fluctuations up to ± 10 % of the nominal voltage;
6. no pollution or only dry, non-conductive pollution.

FUSES

This instrument contains four fuses. All are accessible from the rear-panel. Two protect the AC prime power input, and two protect the internal DC power supplies. The locations of the fuses on the rear panel are shown in the figure below:

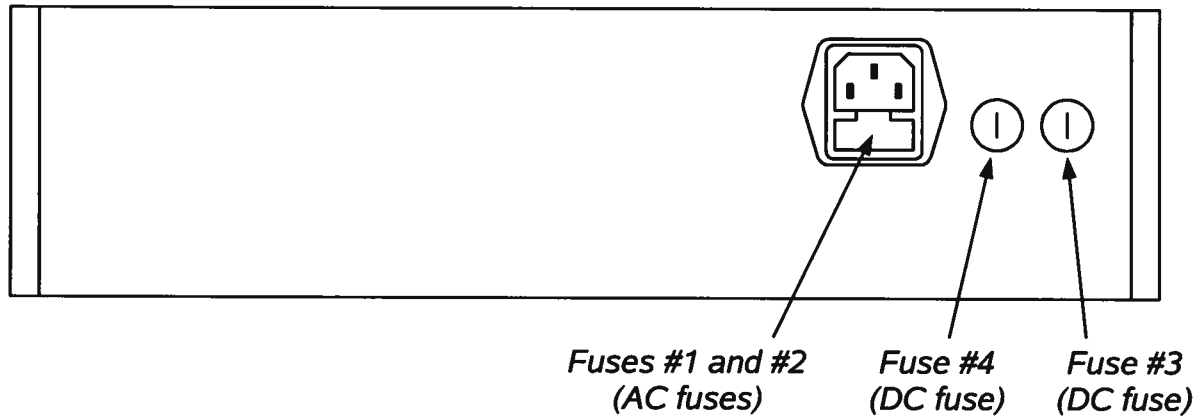

AC FUSE REPLACEMENT

To physically access the AC fuses, the power cord must be detached from the rear panel of the instrument. The fuse drawer may then be extracted using a small flat-head screwdriver, as shown below:

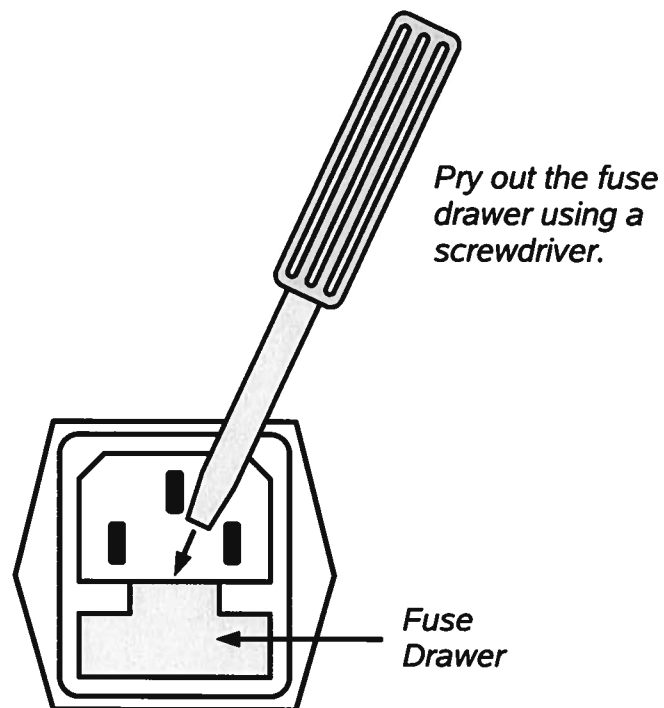

DC FUSE REPLACEMENT

The DC fuses may be replaced by inserting the tip of a flat-head screwdriver into the fuse holder slot, and rotating the slot counter-clockwise. The fuse and its carrier will then pop out.

FUSE RATINGS

The following table lists the required fuses:

Fuses	Nominal Mains Voltage	Rating	Case Size	Recommended Replacement Part	
				Littelfuse Part Number	Digi-Key Stock Number
#1, #2 (AC)	100-240V	0.5A, 250V, Time-Delay	5×20 mm	0218.500HXP	F2416-ND
#3 (DC)	N/A	0.8A, 250V, Time-Delay	5×20 mm	0218.800HXP	F2418-ND
#4 (DC)	N/A	0.5A, 250V, Time-Delay	5×20 mm	0218.500HXP	F2416-ND

The recommended fuse manufacturer is Littelfuse (<http://www.littelfuse.com>).

Replacement fuses may be easily obtained from Digi-Key (<http://www.digikey.com>) and other distributors.

FRONT PANEL CONTROLS

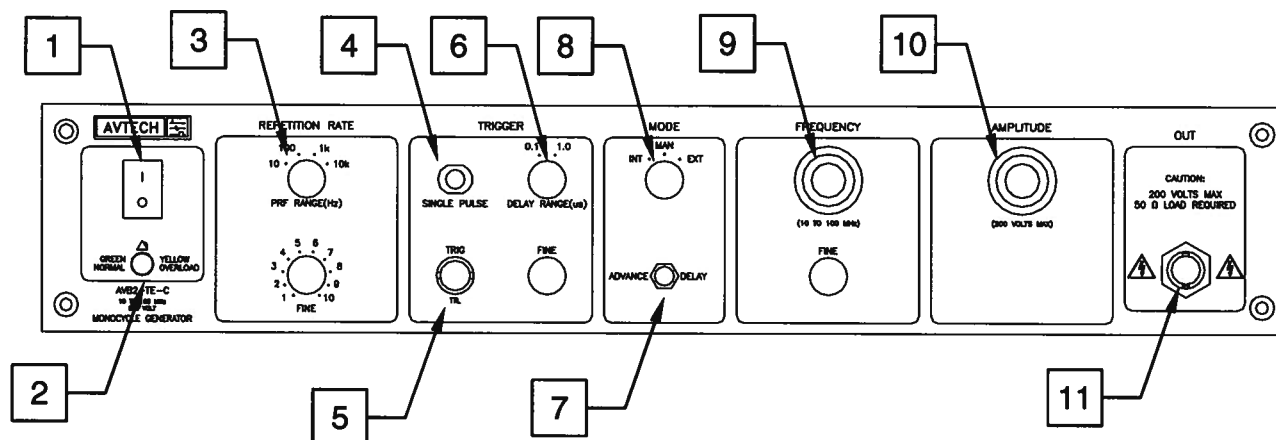

1. **POWER Switch.** This is the main power switch. When turning the instrument on, there may be a delay of several seconds before the instrument appears to respond.
2. **OVERLOAD Indicator.** When the instrument is powered, this indicator is normally green, indicating normal operation. If this indicator is yellow, an internal automatic overload protection circuit has been tripped. If the unit is overloaded (by operating at an exceedingly high duty cycle or by operating into a very low impedance), the protective circuit will disable the output of the instrument and turn the indicator light yellow. The light will stay yellow (i.e. output disabled) for about 5 seconds after which the instrument will attempt to re-enable the output (i.e. light green) for about 1 second. If the overload condition persists, the output will be disabled again (i.e. light yellow) for another 5 seconds. If the overload condition has been removed, the instrument will resume normal operation.

This overload indicator may flash yellow briefly at start-up. This is not a cause for concern.
3. **PRF Range Switch and Vernier.** This switch sets the pulse repetition frequency (PRF) range of the internal oscillator. The marked value of each position is the upper limit of the range, approximately. The vernier dial directly below the switch varies the PRF within the set range.
4. **SINGLE PULSE Push Button.** The "SINGLE PULSE" push button will trigger the instrument manually for one cycle of output, when the "MODE" switch is in the "MAN" position. Otherwise, the push button has no effect.
5. **TRIG Connector.** When the "MODE" switch is in the "EXT" position, this connector is an input. The external trigger (50 ns or wider, TTL levels) is applied to this connector.

When operating in the "INT" mode, this connector is an output. A SYNC output is

generated on this connector, to synchronize oscilloscopes or other measurement systems.

6. Delay Range Switch and Vernier. This switch and one-turn dial sets the delay between the main output and the TRIG output. The marked value of each switch position is the upper limit of the range, approximately. The vernier dial directly below the switch varies the delay within the set range.
7. ADVANCE/DELAY Switch. With this switch in the DELAY position, the leading edge of the output pulse precedes the leading edge of the TRIG output. When in the ADVANCE position, the leading edge of the TRIG output precedes the leading edge of the main output.
8. MODE Switch. In the "INT" position the instrument is internally triggered and the TRIG connector provides a SYNC output which allows one to trigger other instruments, such as oscilloscopes.

In the "MAN" position a single pulse can be generated by pressing the "SINGLE PULSE" push button. The TRIG connector is not used in this mode.

In the "EXT" position the instrument is triggered by a TTL-level pulse on the TRIG connector.

9. FREQUENCY Controls. These dials vary the center frequency of the waveform (not the pulse repetition frequency) between 10 and 100 MHz.

The "FINE" control varies the "dead space" between the positive and negative pulses, and should initially be set to mid-range. When generating frequencies close to 100 MHz, it will be necessary to set this control fully counter-clockwise.

10. AMPLITUDE Controls. This ten-turn dial provides continuously variable control of the peak amplitude of the main output from 0 to the full-scale range value.
11. OUT CONNECTOR. This BNC connector provides the main output signal, into load impedances of 50Ω or higher.

 **Caution:** Voltages as high as ±100V may be present on the center conductor of this output connector. Avoid touching this conductor. Connect to this connector using standard coaxial cable, to ensure that the center conductor is not exposed.

Units with the -PN or -PI Options will have an additional switch controlling the polarity phase. On standard models, the positive portion of the monocycle precedes the negative portion. The -PN option allows this to be order to be reversed, using a front-panel switch. The -PI option also includes this polarity reversal mode, and adds an additional mode where polarity phase of every second monocycle is reversed. That is, the monocycle polarity alternates as +/-, -/+, +/-, -/+, etc.

REAR PANEL CONTROLS

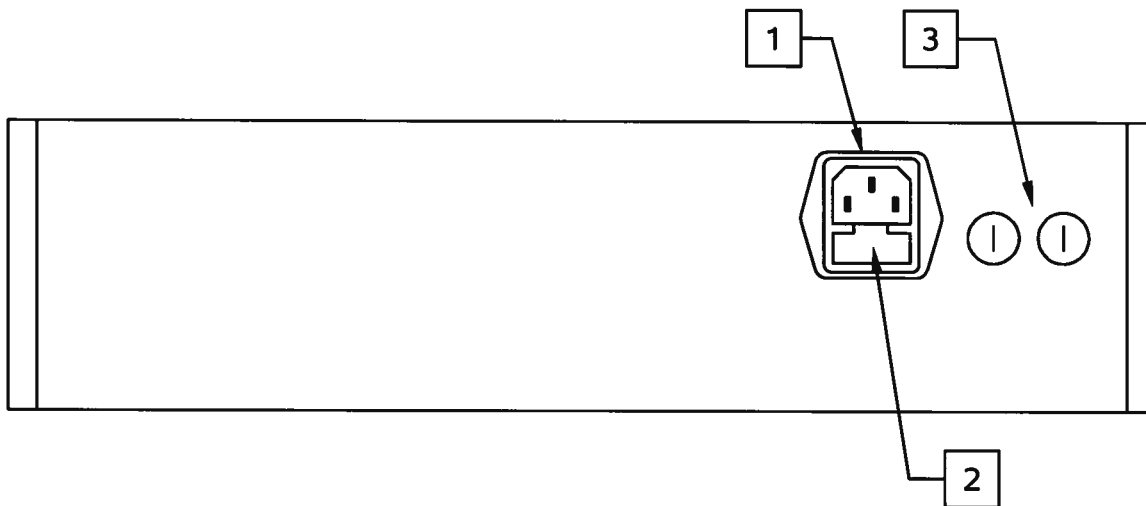

- 1) AC POWER INPUT. An IEC-320 C14 three-pronged recessed male socket is provided on the back panel for AC power connection to the instrument. One end of the detachable power cord that is supplied with the instrument plugs into this socket.
- 2) AC FUSE DRAWER. The two fuses that protect the AC input are located in this drawer. Please see the “FUSES” section of this manual for more information.
- 3) DC FUSES. These two fuses protect the internal DC power supplies. Please see the “FUSES” sections of this manual for more information.

When triggering externally, the instrument can be set such that the output pulse width tracks the pulse width on this input, or the output pulse width can be set independently.

GENERAL INFORMATION

BASIC TEST ARRANGEMENT

The AVB2-TE-C should be tested with a sampling oscilloscope with a bandwidth of at least 2 GHz to properly observe the high-speed waveform. (The cables and attenuators must also have a bandwidth of at least 2 GHz.) A typical test arrangement is shown below:

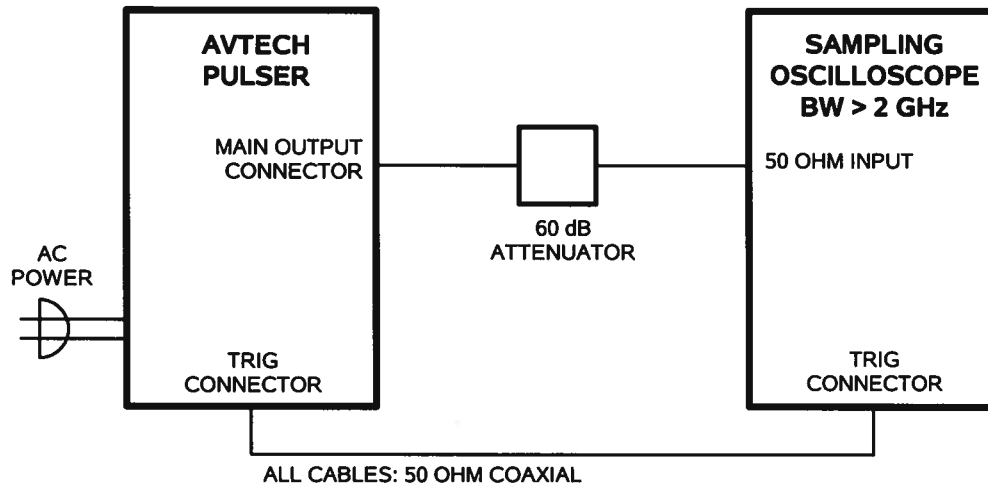

The attenuators are required to prevent damage to the sampling oscilloscope. A 60 dB attenuator with sufficient voltage rating should be used on the main output.

BASIC PULSE CONTROL

This instrument can be triggered by its own internal clock or by an external TTL trigger signal. When triggered internally, two mainframe output channels respond to the trigger: OUT and SYNC.

- OUT. This is the main output. The maximum output voltage is 50V.
- TRIG. The TRIG pulse is a fixed-width TTL-level reference pulse used to trigger oscilloscopes or other measurement systems.

When the ADVANCE/DELAY switch is set to "ADVANCE", the TRIG output precedes the main output. These pulses are illustrated below:

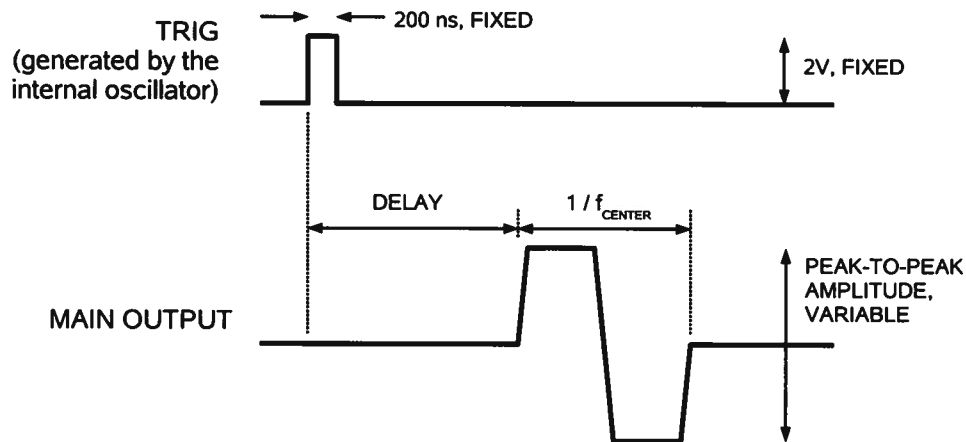

When the ADVANCE/DELAY switch is set to "DELAY", the TRIG output occurs after the main output. This illustrated below:

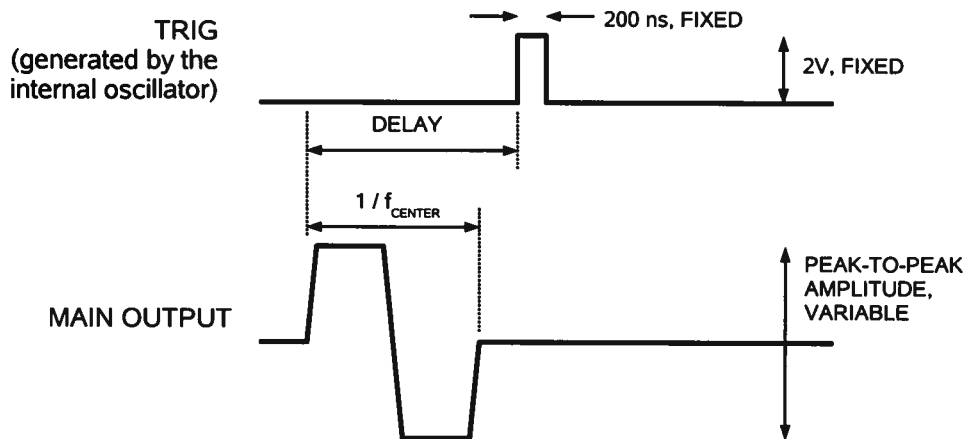

When triggered externally, the TRIG connector acts as an input. The delay controls do not function in this mode. This illustrated below:

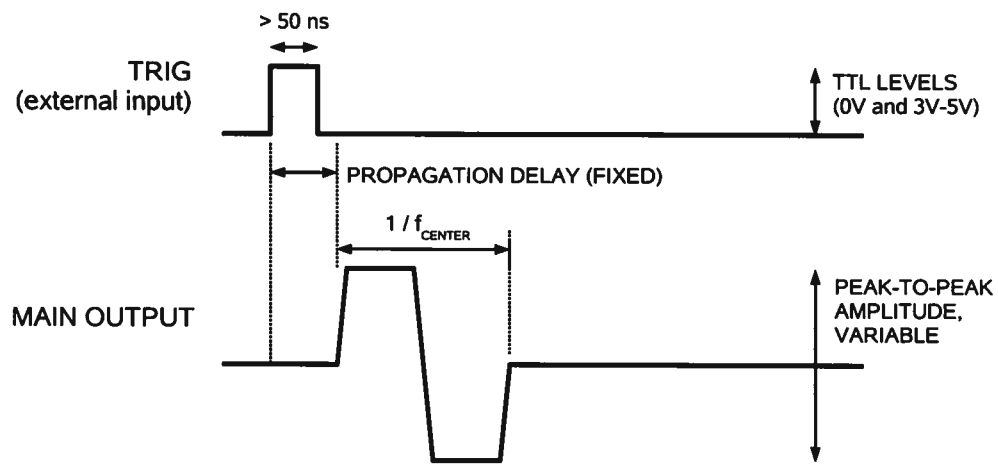

-PN OPTION

Instruments with the -PN option can set the instrument so that the negative portion of the waveform precedes the positive portion. For instance, in this mode, the internally-triggered delayed waveform would look like:

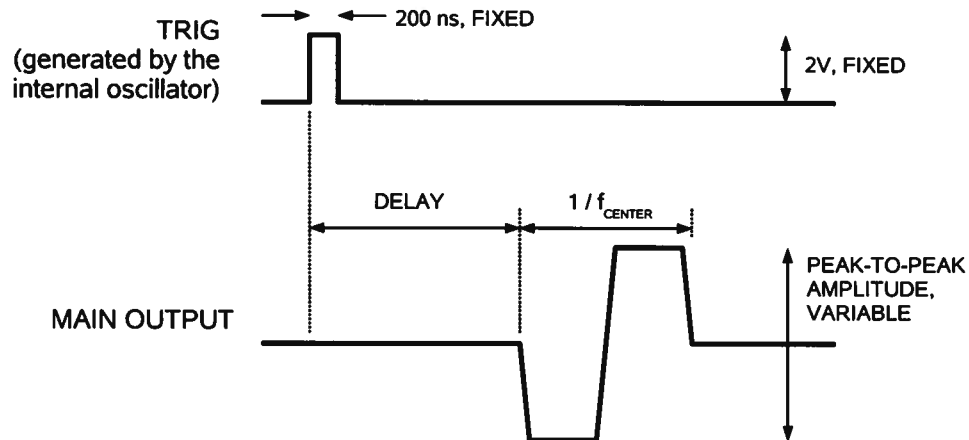

-PI OPTION

The -PI option also includes the -PN polarity reversal mode described above, and adds an additional mode where polarity phase of every second monocyte is reversed. That is, the monocyte polarity alternates as +/-, -/+, +/-, -/+, etc. For instance, in this mode, the output waveform would look like:

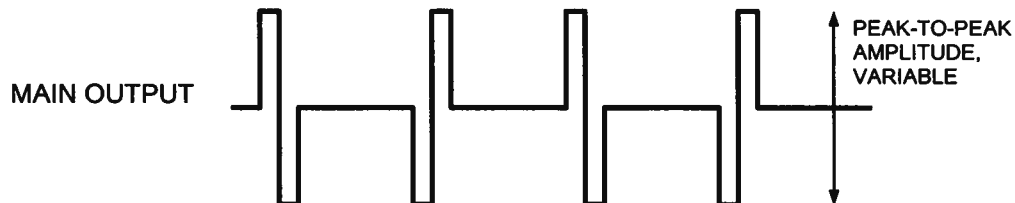

MINIMIZING WAVEFORM DISTORTIONS

USE 50Ω TRANSMISSION LINES AND LOADS

Connect the load to the pulse generator with 50Ω transmission lines (e.g. RG-58 or RG-174 cable).

This instrument requires a 50Ω load for proper operation. It will not properly drive a high-impedance load. The output stage will be damaged if it is operated into an open circuit (or any other high impedance). Failures due to improper output loading are not covered by the warranty.

USE LOW-INDUCTANCE LOADS

Lenz's Law predicts that for an inductive voltage spike will be generated when the current through an inductance changes. Specifically, $V_{\text{SPIKE}} = L \times dI_{\text{LOAD}}/dt$, where L is the inductance, I_{LOAD} is the load current change, and t is time. For this reason, it is important to keep any parasitic in the load low. This means keeping wiring short, and using low inductance components. In particular, wire-wound resistors should be avoided.

PROTECTING YOUR INSTRUMENT

TURN OFF INSTRUMENT WHEN NOT IN USE

The lifetime of the switching elements in the pulse generator module is proportional to the running time of the instrument. For this reason the prime power to the instrument should be turned off when the instrument is not in use. In the case of failure, the switching elements are easily replaced following the procedure described in a following section.

DO NOT EXCEED 10 kHz

The output stage may be damaged if triggered by an external signal at a pulse repetition frequency greater than 10 kHz.

USE A 50 OHM LOAD

The output stage may be damaged if the output is not terminated into a 50 Ω load.

MECHANICAL INFORMATION

TOP COVER REMOVAL

If necessary, the interior of the instrument may be accessed by removing the four Phillips screws on the top panel. With the four screws removed, the top cover may be slid back (and off).

 Always disconnect the power cord and allow the instrument to sit unpowered for 10 minutes before opening the instrument. This will allow any internal stored charge to discharge.

There are no user-adjustable internal circuits. For repairs other than fuse replacement, please contact Avtech (info@avtechpulse.com) to arrange for the instrument to be returned to the factory for repair. Service is to be performed solely by qualified service personnel.

 Caution: High voltages are present inside the instrument during normal operation. Do not operate the instrument with the cover removed.

RACK MOUNTING

A rack mounting kit is available. The -R5 rack mount kit may be installed after first removing the one Phillips screw on the side panel adjacent to the front handle.

ELECTROMAGNETIC INTERFERENCE

To prevent electromagnetic interference with other equipment, all used outputs should be connected to shielded loads using shielded coaxial cables. Unused outputs should be terminated with shielded coaxial terminators or with shielded coaxial dust caps, to prevent unintentional electromagnetic radiation. All cords and cables should be less than 3m in length.

MAINTENANCE

REGULAR MAINTENANCE

This instrument does not require any regular maintenance.

On occasion, one or more of the four rear-panel fuses may require replacement. All fuses can be accessed from the rear panel. See the “FUSES” section for details.

CLEANING

If desired, the interior of the instrument may be cleaned using compressed air to dislodge any accumulated dust. (See the “TOP COVER REMOVAL” section for instructions on accessing the interior.) No other cleaning is recommended.

at 12/06