



**AVTECH ELECTROSYSTEMS LTD.**

NANOSECOND WAVEFORM ELECTRONICS  
SINCE 1975

P.O. BOX 265  
OGDENSBURG, NY  
U.S.A. 13669-0265  
TEL: (315) 472-5270  
FAX: (315) 883-1328

TEL: 1-800-265-6681  
FAX: 1-800-561-1970

e-mail: [info@avtechpulse.com](mailto:info@avtechpulse.com)  
<http://www.avtechpulse.com/>

BOX 5120, LCD MERIVALE  
OTTAWA, ONTARIO  
CANADA K2C 3H4  
TEL: (613) 226-5772  
FAX: (613) 226-2802

INSTRUCTIONS

MODEL AVIR-4-C

0 TO 200 VOLTS, 20 kHz

HIGH SPEED PULSE GENERATOR

WITH 1-2 ns RISE TIMES

SERIAL NUMBER: \_\_\_\_\_

### WARRANTY

Avtech Electrosystems Ltd. warrants products of its manufacture to be free from defects in material and workmanship under conditions of normal use. If, within one year after delivery to the original owner, and after prepaid return by the original owner, this Avtech product is found to be defective, Avtech shall at its option repair or replace said defective item. This warranty does not apply to units which have been disassembled, modified or subjected to conditions exceeding the applicable specifications or ratings. This warranty is the extent of the obligation assumed by Avtech with respect to this product and no other warranty or guarantee is either expressed or implied.

### TECHNICAL SUPPORT

Phone: 613-226-5772 or 1-800-265-6681

Fax: 613-226-2802 or 1-800-561-1970

E-mail: [info@avtechpulse.com](mailto:info@avtechpulse.com)

World Wide Web: <http://www.avtechpulse.com>

## TABLE OF CONTENTS

<b>WARRANTY.....</b>	<b>2</b>
<b>TECHNICAL SUPPORT.....</b>	<b>2</b>
<b>TABLE OF CONTENTS.....</b>	<b>3</b>
<b>INTRODUCTION.....</b>	<b>5</b>
<b>AVAILABLE OPTIONS.....</b>	<b>5</b>
<b>SPECIFICATIONS.....</b>	<b>6</b>
<b>EUROPEAN REGULATORY NOTES.....</b>	<b>7</b>
<b>EC DECLARATION OF CONFORMITY.....</b>	<b>7</b>
<b>DIRECTIVE 2002/95/EC (RoHS).....</b>	<b>7</b>
<b>DIRECTIVE 2002/96/EC (WEEE).....</b>	<b>7</b>
<b>INSTALLATION.....</b>	<b>9</b>
<b>VISUAL CHECK.....</b>	<b>9</b>
<b>POWER RATINGS.....</b>	<b>9</b>
<b>CONNECTION TO THE POWER SUPPLY.....</b>	<b>9</b>
<b>PROTECTION FROM ELECTRIC SHOCK.....</b>	<b>10</b>
<b>ENVIRONMENTAL CONDITIONS.....</b>	<b>10</b>
<b>FUSES.....</b>	<b>12</b>
<b>AC FUSE REPLACEMENT.....</b>	<b>12</b>
<b>DC FUSE REPLACEMENT.....</b>	<b>13</b>
<b>FUSE RATINGS.....</b>	<b>13</b>
<b>FRONT PANEL CONTROLS.....</b>	<b>14</b>
<b>REAR PANEL CONTROLS.....</b>	<b>16</b>
<b>GENERAL INFORMATION.....</b>	<b>18</b>
<b>BASIC TEST ARRANGEMENT.....</b>	<b>18</b>
<b>GENERAL OPERATING NOTES.....</b>	<b>18</b>
<b>MINIMIZING WAVEFORM DISTORTIONS.....</b>	<b>20</b>
<b>USE 50 OHM TRANSMISSION LINES AND LOADS.....</b>	<b>20</b>
<b>USE LOW-INDUCTANCE LOADS.....</b>	<b>20</b>
<b>PREVENTING DAMAGE.....</b>	<b>20</b>
<b>MECHANICAL INFORMATION.....</b>	<b>21</b>
<b>TOP COVER REMOVAL.....</b>	<b>21</b>
<b>RACK MOUNTING.....</b>	<b>21</b>

<b>ELECTROMAGNETIC INTERFERENCE.....</b>	<b>21</b>
<b><i>MAINTENANCE.....</i></b>	<b>22</b>
<b>REGULAR MAINTENANCE.....</b>	<b>22</b>
<b>CLEANING.....</b>	<b>22</b>
<b><i>WIRING DIAGRAMS.....</i></b>	<b>23</b>
<b>WIRING OF AC POWER, 1/2.....</b>	<b>23</b>
<b>WIRING OF AC POWER, 2/2.....</b>	<b>24</b>
<b>PCB 158K - LOW VOLTAGE POWER SUPPLY, 1/3.....</b>	<b>25</b>
<b>PCB 158K - LOW VOLTAGE POWER SUPPLY, 2/3.....</b>	<b>26</b>
<b>PCB 158K - LOW VOLTAGE POWER SUPPLY, 3/3.....</b>	<b>27</b>
<b>PCB 168B - HIGH VOLTAGE DC POWER SUPPLY.....</b>	<b>28</b>
<b>PCB 80B - TIMING BOARD (1/2).....</b>	<b>29</b>
<b>PCB 80B - TIMING BOARD (2/2).....</b>	<b>30</b>
<b>MAIN WIRING - TIMING CONTROL.....</b>	<b>31</b>
<b>MAIN WIRING.....</b>	<b>32</b>
<b><i>PERFORMANCE CHECK SHEET.....</i></b>	<b>33</b>

Manual Reference: T:\instructword\avir\AVIR-4-Cedd.odt.  
 Last modified March 22, 2006.  
 Copyright © 2006 Avtech Electrosystems Ltd, All Rights Reserved.

## INTRODUCTION

The AVIR-4-C is a high performance instrument capable of generating up to 200V into 50Ω loads at repetition rates up to 20 kHz. The output pulse width is variable from 2 to 200 ns. The rise time is fixed at less than 1 ns for pulse widths less than 10 ns, and less than 2 ns for pulse widths of 10-200 ns. The fall time is less than 2 ns, for all pulse widths.

Instruments with the "-P" model suffix can generate 0 to +200V, whereas instruments with the "-N" model suffix can generate 0 to -200V. Instruments with the "-PN" suffix can generate both polarities.

The output is designed to drive 50Ω loads. (A 50Ω load is required for proper operation.) The output is AC-coupled.

This instrument is intended for use in research, development, test and calibration laboratories by qualified personnel.

## AVAILABLE OPTIONS

This instrument is available with several options:

-EA Option: the amplitude can be controlled by an externally generated 0 to +10V analog control voltage.

-EW Option: the pulse width can be controlled by an externally generated 0 to +10V analog control voltage.

-M Option: a monitor output is provided.

-OS Option: an externally generated DC offset can be added to the output.

## SPECIFICATIONS

Model:	AVIR-4-C <sup>1</sup>
Amplitude <sup>3,4,5</sup> :	0 to 200 Volts (50Ω load required)
Pulse width (FWHM) <sup>4</sup> :	2 - 200 ns
Max. rise time: (20%-80%)	1 ns (PW<10ns) 2 ns (PW≥10ns)
Max. fall time: (80%-20%)	2 ns
PRF:	0 to 20 kHz
Polarity <sup>6</sup> :	Positive or negative or both (specify)
Propagation delay:	≤ 100 ns (Ext trig in to pulse out)
Jitter:	± 35ps ± 0.015% of sync delay (Ext trig in to pulse out)
DC offset or bias insertion:	Optional <sup>9</sup> . Apply required DC offset or bias in the range of ± 50 Volts (250 mA max) to back panel solder terminal..
Trigger required:	Ext trig mode: + 5 Volts, 50 ns or wider (TTL)
Sync delay:	Sync out to pulse out, variable 0 to ± 500 ns
Sync output	+3 Volts, 200 ns, will drive 50 Ohm loads
Connectors:	Out: SMA Trig/Sync: BNC
Power requirement:	100 - 240 Volts, 50 - 60 Hz
Dimensions (H x W x D):	100 × 430 × 375 mm (3.9 × 17 × 14.8")
Chassis material:	cast aluminum frame & handles, blue vinyl on aluminum cover plates
Temperature range:	+5°C to +40°C

- 1) -C suffix indicates stand-alone lab instrument with internal clock and line powering.
- 2) -B suffix indicates IEEE-488.2 GPIB and RS-232 control of amplitude, pulse width, PRF and delay (see <http://www.avtechpulse.com/gpib> for details).
- 3) For electronic control (0 to +10V) of amplitude, suffix the model number with -EA. Includes standard front-panel controls. Not available on AVIR-4 models.
- 4) For 10-turn dial control of pulse width (or amplitude) suffix model number with -PWT (or -AT). Not applicable for -B units.
- 5) For operation at amplitudes of less than 10% of full-scale, best results will be obtained by setting the amplitude near full-scale and using external attenuators on the output.
- 6) Indicate desired polarity by suffixing model number with -P or -N (i.e. positive or negative) or -PN for dual polarity option. Polarity reversal is achieved by means of a two-position switch.
- 7) Add the suffix -TNT to the model number to specify the Internet control (Telnet and Web) option.
- 8) Add the suffix -BR to the model number to specify the burst mode option. See <http://www.avtechpulse.com/options/br> for details about this option.
- 9) For DC offset option suffix model number with -OS.

## EUROPEAN REGULATORY NOTES

### EC DECLARATION OF CONFORMITY

We                    Avtech Electrosystems Ltd.  
                         P.O. Box 5120, LCD Merivale  
                         Ottawa, Ontario  
                         Canada K2C 3H4

declare that this pulse generator meets the intent of Directive 89/336/EEC for Electromagnetic Compatibility. Compliance pertains to the following specifications as listed in the official Journal of the European Communities:

EN 50081-1 Emission

EN 50082-1 Immunity

and that this pulse generator meets the intent of the Low Voltage Directive 72/23/EEC as amended by 93/68/EEC. Compliance pertains to the following specifications as listed in the official Journal of the European Communities:

EN 61010-1:2001 Safety requirements for electrical equipment for measurement, control, and laboratory use



### DIRECTIVE 2002/95/EC (RoHS)

This instrument is exempt from Directive 2002/95/EC of the European Parliament and of the Council of 27 January 2003 on the Restriction of the use of certain Hazardous Substances (RoHS) in electrical and electronic equipment. Specifically, Avtech instruments are considered "Monitoring and control instruments" (Category 9) as defined in Annex 1A of Directive 2002/96/EC. The Directive 2002/95/EC only applies to Directive 2002/96/EC categories 1-7 and 10, as stated in the "Article 2 - Scope" section of Directive 2002/95/EC.

### DIRECTIVE 2002/96/EC (WEEE)

European customers who have purchased this equipment directly from Avtech will have completed a "WEEE Responsibility Agreement" form, accepting responsibility for

WEEE compliance (as mandated in Directive 2002/96/EC of the European Union and local laws) on behalf of the customer, as provided for under Article 9 of Directive 2002/96/EC.

Customers who have purchased Avtech equipment through local representatives should consult with the representative to determine who has responsibility for WEEE compliance. Normally, such responsibilities will lie with the representative, unless other arrangements (under Article 9) have been made.

Requirements for WEEE compliance may include registration of products with local governments, reporting of recycling activities to local governments, and financing of recycling activities.

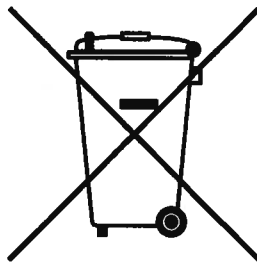



## INSTALLATION

### VISUAL CHECK

After unpacking the instrument, examine to ensure that it has not been damaged in shipment. Visually inspect all connectors, knobs, and handles. Confirm that a power cord and an instrumentation manual (this manual), are with the instrument. If the instrument has been damaged, file a claim immediately with the company that transported the instrument.

### POWER RATINGS

This instrument is intended to operate from 100 - 240 V, 50 - 60 Hz.

The maximum power consumption is 57 Watts. Please see the "FUSES" section for information about the appropriate AC and DC fuses.

This instrument is an "Installation Category II" instrument, intended for operation from a normal single-phase supply.

### CONNECTION TO THE POWER SUPPLY

An IEC-320 three-pronged recessed male socket is provided on the back panel for AC power connection to the instrument. One end of the detachable power cord that is supplied with the instrument plugs into this socket. The other end of the detachable power cord plugs into the local mains supply. Use only the cable supplied with the instrument. The mains supply must be earthed, and the cord used to connect the instrument to the mains supply must provide an earth connection. (The supplied cord does this.)

 **Warning:** Failure to use a grounded outlet may result in injury or death due to electric shock. This product uses a power cord with a ground connection. It must be connected to a properly grounded outlet. The instrument chassis is connected to the ground wire in the power cord.

The table below describes the power cord that is supplied with this instrument, depending on the destination region:

Destination Region	Description	Manufacturer	Part Number
Continental Europe	European CEE 7/7 "Schuko" 230V, 50Hz	Volex ( <a href="http://www.volex.com">http://www.volex.com</a> )	17850-C3-326
United Kingdom	BS 1363, 230V, 50Hz	Volex ( <a href="http://www.volex.com">http://www.volex.com</a> )	17962-C3-10
Switzerland	SEV 1011, 230V, 50Hz	Volex ( <a href="http://www.volex.com">http://www.volex.com</a> )	2102H-C3-10
Israel	SI 32, 220V, 50Hz	Volex ( <a href="http://www.volex.com">http://www.volex.com</a> )	2115H-C3-10
North America, and all other areas	NEMA 5-15, 120V, 60 Hz	Volex ( <a href="http://www.volex.com">http://www.volex.com</a> )	17250-B1-10
		Qualtek ( <a href="http://www.qualtekusa.com">http://www.qualtekusa.com</a> )	312007-01

## PROTECTION FROM ELECTRIC SHOCK

 Operators of this instrument must be protected from electric shock at all times. The owner must ensure that operators are prevented access and/or are insulated from every connection point. In some cases, connections must be exposed to potential human contact. Operators must be trained to protect themselves from the risk of electric shock. This instrument is intended for use by qualified personnel who recognize shock hazards and are familiar with safety precautions required to avoid possibly injury. In particular, operators should:

1. Keep exposed high-voltage wiring to an absolute minimum.
2. Wherever possible, use shielded connectors and cabling.
3. Connect and disconnect loads and cables only when the instrument is turned off.
4. Keep in mind that all cables, connectors, oscilloscope probes, and loads must have an appropriate voltage rating.
5. Do not attempt any repairs on the instrument, beyond the fuse replacement procedures described in this manual. Contact Avtech technical support (see page 2 for contact information) if the instrument requires servicing. Service is to be performed solely by qualified service personnel.

## ENVIRONMENTAL CONDITIONS

This instrument is intended for use under the following conditions:

- a) indoor use;
- b) altitude up to 2 000 m;
- c) temperature 5 °C to 40 °C;
- d) maximum relative humidity 80 % for temperatures up to 31 °C decreasing linearly to 50 % relative humidity at 40 °C;
- e) Mains supply voltage fluctuations up to  $\pm 10$  % of the nominal voltage;

f) no pollution or only dry, non-conductive pollution.

## FUSES

This instrument contains four fuses. All are accessible from the rear-panel. Two protect the AC prime power input, and two protect the internal DC power supplies. The locations of the fuses on the rear panel are shown in the figure below:

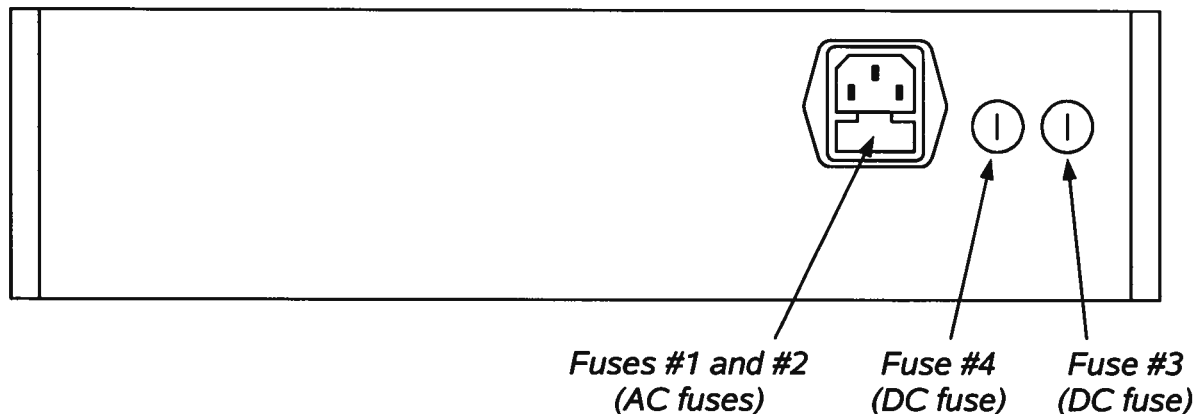

### AC FUSE REPLACEMENT

To physically access the AC fuses, the power cord must be detached from the rear panel of the instrument. The fuse drawer may then be extracted using a small flat-head screwdriver, as shown below:

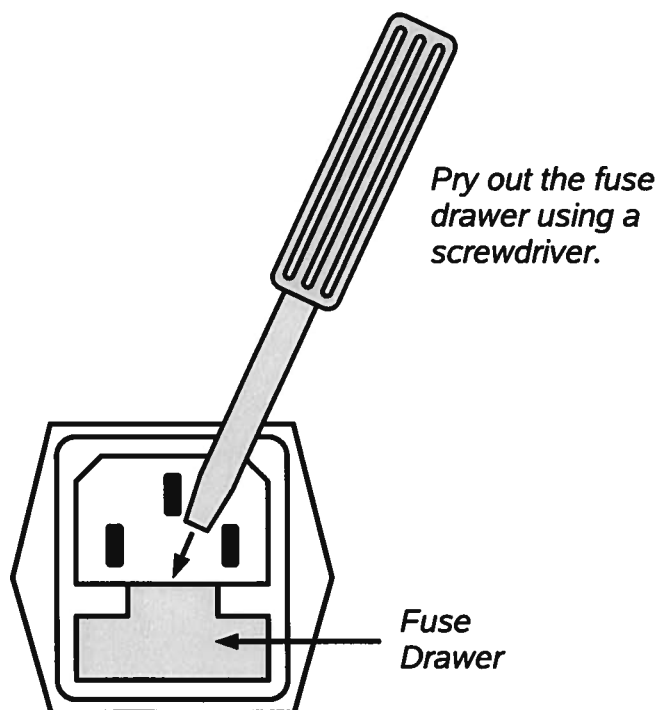

## DC FUSE REPLACEMENT

The DC fuses may be replaced by inserting the tip of a flat-head screwdriver into the fuse holder slot, and rotating the slot counter-clockwise. The fuse and its carrier will then pop out.

## FUSE RATINGS

The following table lists the required fuses:

Fuses	Nominal Mains Voltage	Rating	Case Size	Recommended Replacement Part	
				Littelfuse Part Number	Digi-Key Stock Number
#1, #2 (AC)	100-240V	0.5A, 250V, Time-Delay	5×20 mm	0218.500HXP	F2416-ND
#3 (DC)	N/A	1.6A, 250V, Time-Delay	5×20 mm	021801.6HXP	F2424-ND
#4 (DC)	N/A	0.8A, 250V, Time-Delay	5×20 mm	0218.800HXP	F2418-ND

The recommended fuse manufacturer is Littelfuse (<http://www.littelfuse.com>).

Replacement fuses may be easily obtained from Digi-Key (<http://www.digikey.com>) and other distributors.

## FRONT PANEL CONTROLS

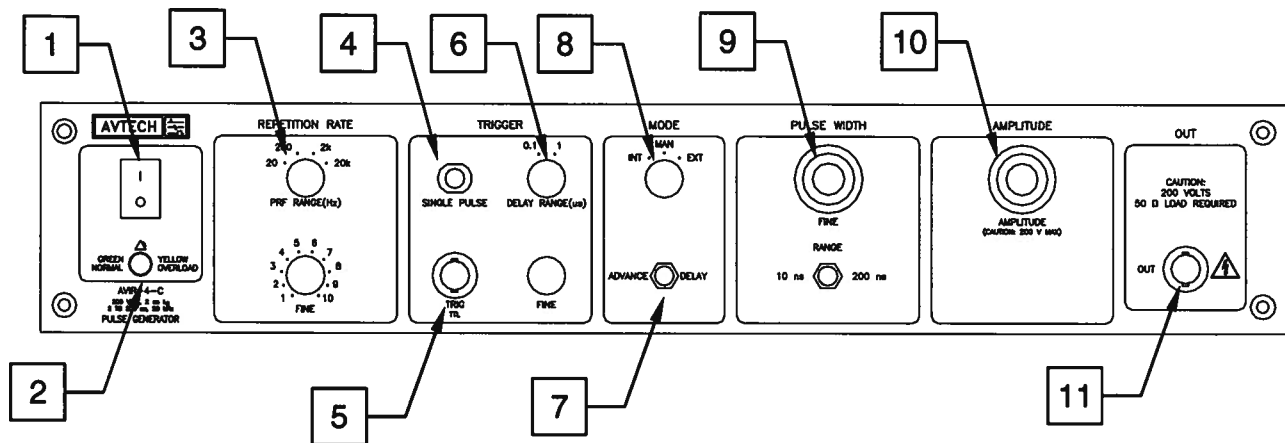

1. **POWER Switch.** This is the main power switch.
2. **OVERLOAD Indicator.** When the instrument is powered, this indicator is normally green, indicating normal operation. If this indicator is yellow, an internal automatic overload protection circuit has been tripped. If the unit is overloaded (by operating at an exceedingly high duty cycle or by operating into a very low impedance), the protective circuit will disable the output of the instrument and turn the indicator light yellow. The light will stay yellow (i.e. output disabled) for about 5 seconds after which the instrument will attempt to re-enable the output (i.e. light green) for about 1 second. If the overload condition persists, the output will be disabled again (i.e. light yellow) for another 5 seconds. If the overload condition has been removed, the instrument will resume normal operation.

This overload indicator may flash yellow briefly at start-up. This is not a cause for concern.

3. **PRF Range Switch and Vernier.** This switch sets the pulse repetition frequency (PRF) range of the internal oscillator. The marked value of each position is the upper limit of the range, approximately. The vernier dial directly below the switch varies the PRF within the set range.
4. **SINGLE PULSE Push Button.** The "SINGLE PULSE" push button will trigger the instrument manually for one cycle of output, when the "MODE" switch is in the "MAN" position. Otherwise, the push button has no effect.
5. **TRIG Connector.** When the "MODE" switch is in the "EXT" position, this connector is an input. The external trigger (50 ns or wider, TTL levels) is applied to this connector.

When operating in the "INT" mode, this connector is an output. A SYNC output is generated on this connector, to synchronize oscilloscopes or other measurement

systems.

6. Delay Range Switch and Vernier. This switch and one-turn dial sets the delay between the main output and the TRIG output. The marked value of each switch position is the upper limit of the range, approximately. The vernier dial directly below the switch varies the delay within the set range.
7. ADVANCE/DELAY Switch. With this switch in the DELAY position, the leading edge of the output pulse precedes the leading edge of the TRIG output. When in the ADVANCE position, the leading edge of the TRIG output precedes the leading edge of the main output.
8. MODE Switch. In the "INT" position the instrument is internally triggered and the TRIG connector provides a SYNC output which allows one to trigger other instruments, such as oscilloscopes.

In the "MAN" position a single pulse can be generated by pressing the "SINGLE PULSE" push button. The TRIG connector is not used in this mode.

In the "EXT" position the instrument is triggered by a TTL-level pulse on the TRIG connector. The output parameters (pulse width, delay, and amplitude) are determined by the front panel settings.

9. Pulse Width Range Switch and Vernier. This switch and ten-turn dial set the pulse width of the the main output. The marked value of each switch position is the upper limit of the range, approximately. The vernier dial directly below the switch varies the delay within the set range.
10. AMPLITUDE Controls. This ten-turn dial provides continuously variable control of the peak amplitude of the main output from 0 to the full-scale range value.
11. OUT CONNECTOR. This BNC connector provides the main output signal, into load impedances of 50 $\Omega$ .

 Caution: Voltages as high as  $\pm 200\text{V}$  may be present on the center conductor of this output connector. Avoid touching this conductor. Connect to this connector using standard coaxial cable, to ensure that the center conductor is not exposed.

## REAR PANEL CONTROLS

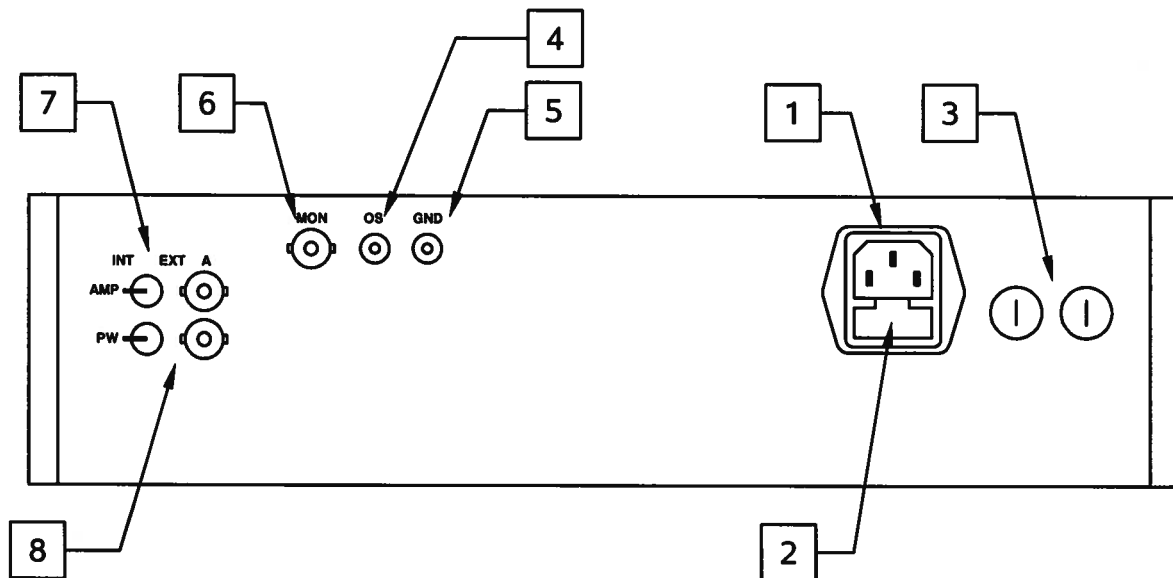

1. **AC POWER INPUT.** An IEC-320 C14 three-pronged recessed male socket is provided on the back panel for AC power connection to the instrument. One end of the detachable power cord that is supplied with the instrument plugs into this socket.
2. **AC FUSE DRAWER.** The two fuses that protect the AC input are located in this drawer. Please see the “FUSES” section of this manual for more information.
3. **DC FUSES.** These two fuses protect the internal DC power supplies. Please see the “FUSES” sections of this manual for more information.
4. **OS INPUT CONNECTOR.** (Present on units with -OS option only.) A DC offset in the range of  $\pm 50\text{V}$  (250 mA max) may be applied to this solder terminal. The DC offset will appear on the output. When this feature is not used, the OS input should be connected to ground (using the adjacent GND connector). This is especially important when driving loads containing a diode.
5. **GND CONNECTOR.** (Present on units with -OS option only.) This solder terminal is connected to ground. It may be used to ground the OS input connector.
6. **MON OUTPUT CONNECTOR.** (Present on units with -M option only.) This SMA connector output provides a 20 dB attenuated coincident replica of main output, for monitoring purposes.
7. **AMP SWITCH & INPUT.** (Present on units with -EA option only.) To control the output amplitude with an external voltage, set the rear-panel switch to the “EXT” position and apply 0 to +10V to the adjacent connector ( $R_{IN} \geq 10\text{k}\Omega$ ).



8. PW SWITCH & INPUT. (Present on units with -EW option only.) To control the output pulse width with an external voltage, set the rear-panel switch to the "EXT" position and apply 0 to +10V to the adjacent connector ( $R_{IN} \geq 10k\Omega$ ).

## GENERAL INFORMATION

### BASIC TEST ARRANGEMENT

The AVIR-4-C should be tested with a sampling oscilloscope with a bandwidth of at least 2 GHz to properly observe the high-speed waveform. A typical test arrangement is shown below:

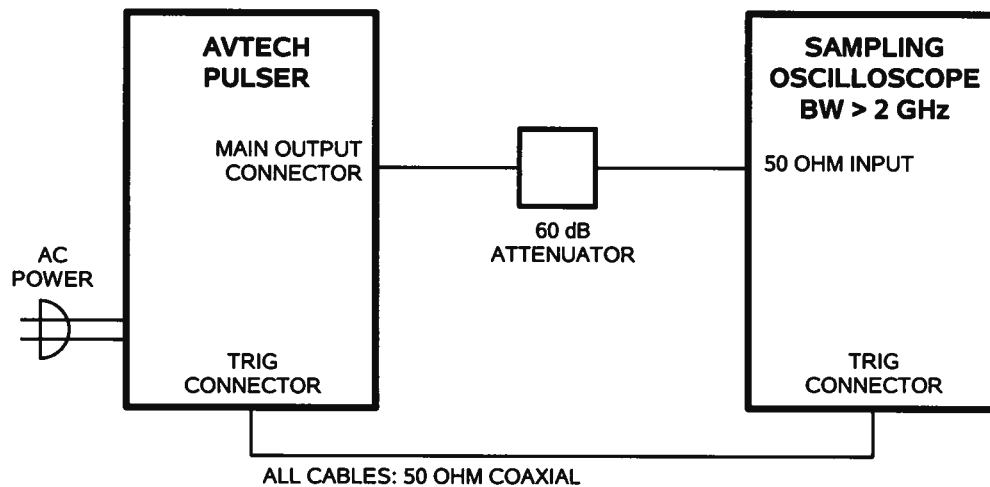

The attenuator is required to prevent damage to the sampling oscilloscope.

### GENERAL OPERATING NOTES

- 1) The bandwidth capability of components and instruments used to display the pulse generator output signal (attenuators, cables, connectors, etc.) should exceed 2 GHz.
- 2) The use of a 60 dB attenuator at the sampling scope vertical input channel will ensure a peak input signal to the sampling scope of less than 1 Volt.
- 3) The TRIG output channel provides TTL level signals. The TRIG output precedes the main output when the front panel ADVANCE-DELAY switch is in the ADVANCE position. The TRIG output lags the main output when the switch is in the DELAY position.
- 4) To obtain a stable output display the PRF control on the front panel should be set mid-range. The front panel MODE switch should be in the INT position. The DELAY controls and the scope triggering controls are then adjusted to obtain a stable output. The scope may then be used to set the desired PRF by rotating the PRF controls.
- 5) The output pulse width is controlled by means of the front panel one-turn PW control and the two-position range switch as follows. The two ranges are 2-10 ns and 10-200 ns.

- 6) The output pulse amplitude is normally controlled by means of the front panel AMP control. To voltage-control the output amplitude, set the rear panel switch in the EXT position and apply 0 to +10V to connector B ( $R_{IN} > 10K$ ). (-EA option).
- 7) To DC offset the output pulse connect a DC power supply set to required DC offset value to the back panel terminals marked OS. The maximum attainable DC offset voltage is 50 Volts / 250 mA (for units with the -OS option only).

## MINIMIZING WAVEFORM DISTORTIONS

### USE 50 OHM TRANSMISSION LINES AND LOADS

Connect the load to the pulse generator with 50Ω transmission lines (e.g. RG-58 or RG-174 cable).

This instrument requires a 50Ω load for proper operation. It will not properly drive a high-impedance load. The output stage will be damaged if it is operated into an open circuit (or any other high impedance). Failures due to improper output loading are not covered by the warranty.

### USE LOW-INDUCTANCE LOADS

Lenz's Law predicts that for an inductive voltage spike will be generated when the current through an inductance changes. Specifically,  $V_{\text{SPIKE}} = L \frac{dI_{\text{LOAD}}}{dt}$ , where  $L$  is the inductance,  $I_{\text{LOAD}}$  is the load current change, and  $t$  is time. For this reason, it is important to keep any parasitic in the load low. This means keeping wiring short, and using low inductance components. In particular, wire-wound resistors should be avoided.

## PREVENTING DAMAGE

The AVIR-4-C may fail if triggered at a PRF greater than 20 kHz.

This unit is designed to operate into a load impedance of 50 Ohms and the output stage will be damaged if it is operated into an open circuit (or any other high impedance). Failures due to improper output loading are not covered by the warranty.

The lifetime of the switching elements in the pulse generator module is proportional to the running time of the instrument. For this reason the prime power to the instrument should be turned off when the instrument is not in use.

## MECHANICAL INFORMATION

### TOP COVER REMOVAL

If necessary, the interior of the instrument may be accessed by removing the four Phillips screws on the top panel. With the four screws removed, the top cover may be slid back (and off).

 Always disconnect the power cord and allow the instrument to sit unpowered for 10 minutes before opening the instrument. This will allow any internal stored charge to discharge.

There are no user-adjustable internal circuits. For repairs other than fuse replacement, please contact Avtech ([info@avtechpulse.com](mailto:info@avtechpulse.com)) to arrange for the instrument to be returned to the factory for repair. Service is to be performed solely by qualified service personnel.

 Caution: High voltages are present inside the instrument during normal operation. Do not operate the instrument with the cover removed.

### RACK MOUNTING

A rack mounting kit is available. The -R5 rack mount kit may be installed after first removing the one Phillips screw on the side panel adjacent to the front handle.

### ELECTROMAGNETIC INTERFERENCE

To prevent electromagnetic interference with other equipment, all used outputs should be connected to shielded loads using shielded coaxial cables. Unused outputs should be terminated with shielded coaxial terminators or with shielded coaxial dust caps, to prevent unintentional electromagnetic radiation. All cords and cables should be less than 3m in length.

## MAINTENANCE

### REGULAR MAINTENANCE

This instrument does not require any regular maintenance.

On occasion, one or more of the four rear-panel fuses may require replacement. All fuses can be accessed from the rear panel. See the "FUSES" section for details.

### CLEANING

If desired, the interior of the instrument may be cleaned using compressed air to dislodge any accumulated dust. (See the "TOP COVER REMOVAL" section for instructions on accessing the interior.) No other cleaning is recommended.







# PCB 158K - LOW VOLTAGE POWER SUPPLY, 1/3

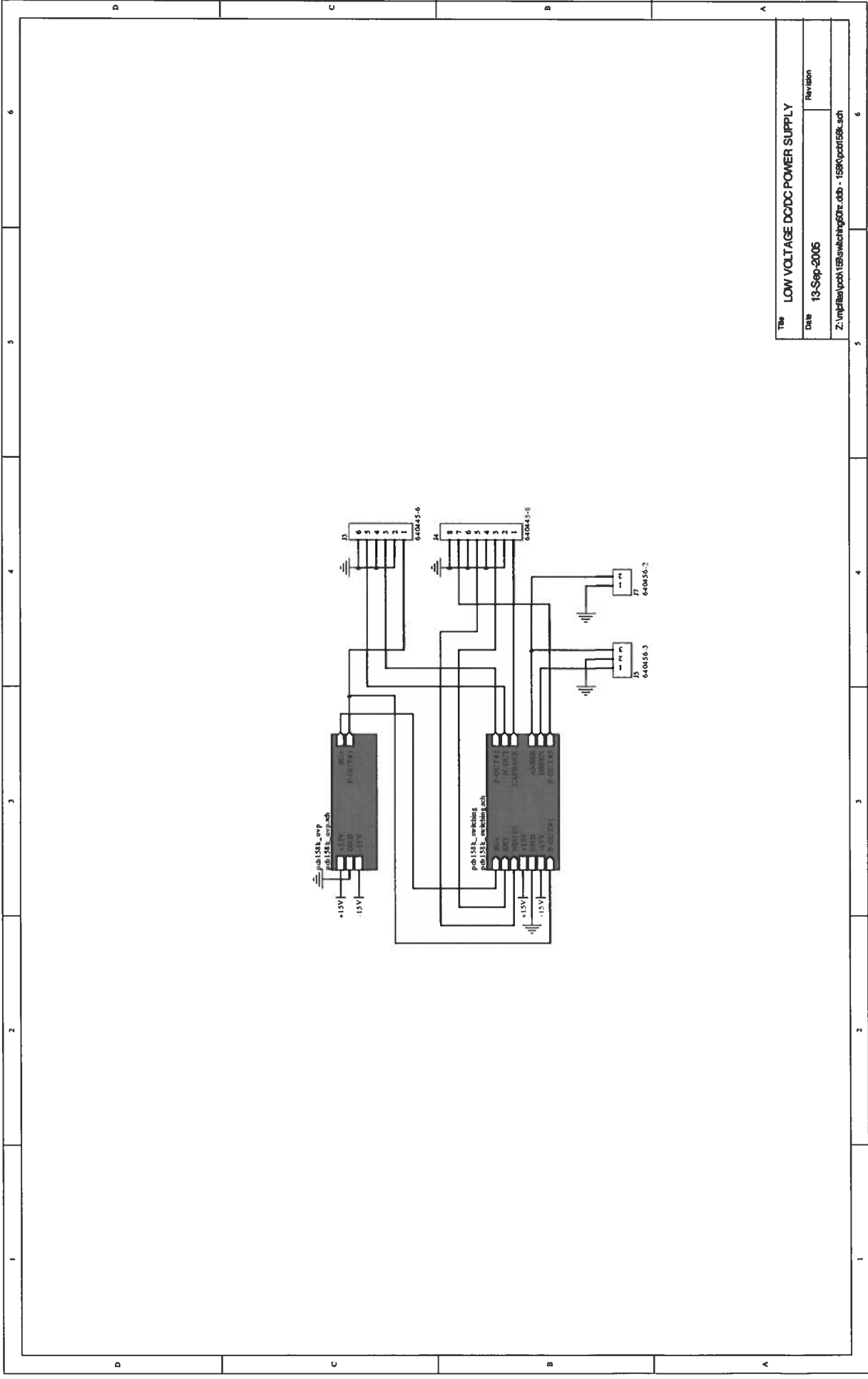

Title		LOW VOLTAGE DC/DC POWER SUPPLY
Date	13-Sep-2005	Revision
Z:\mpfiles\pach\158\switching60tr.dcb - 158K\pcb158k.sch		

# PCB 158K - LOW VOLTAGE POWER SUPPLY, 2/3

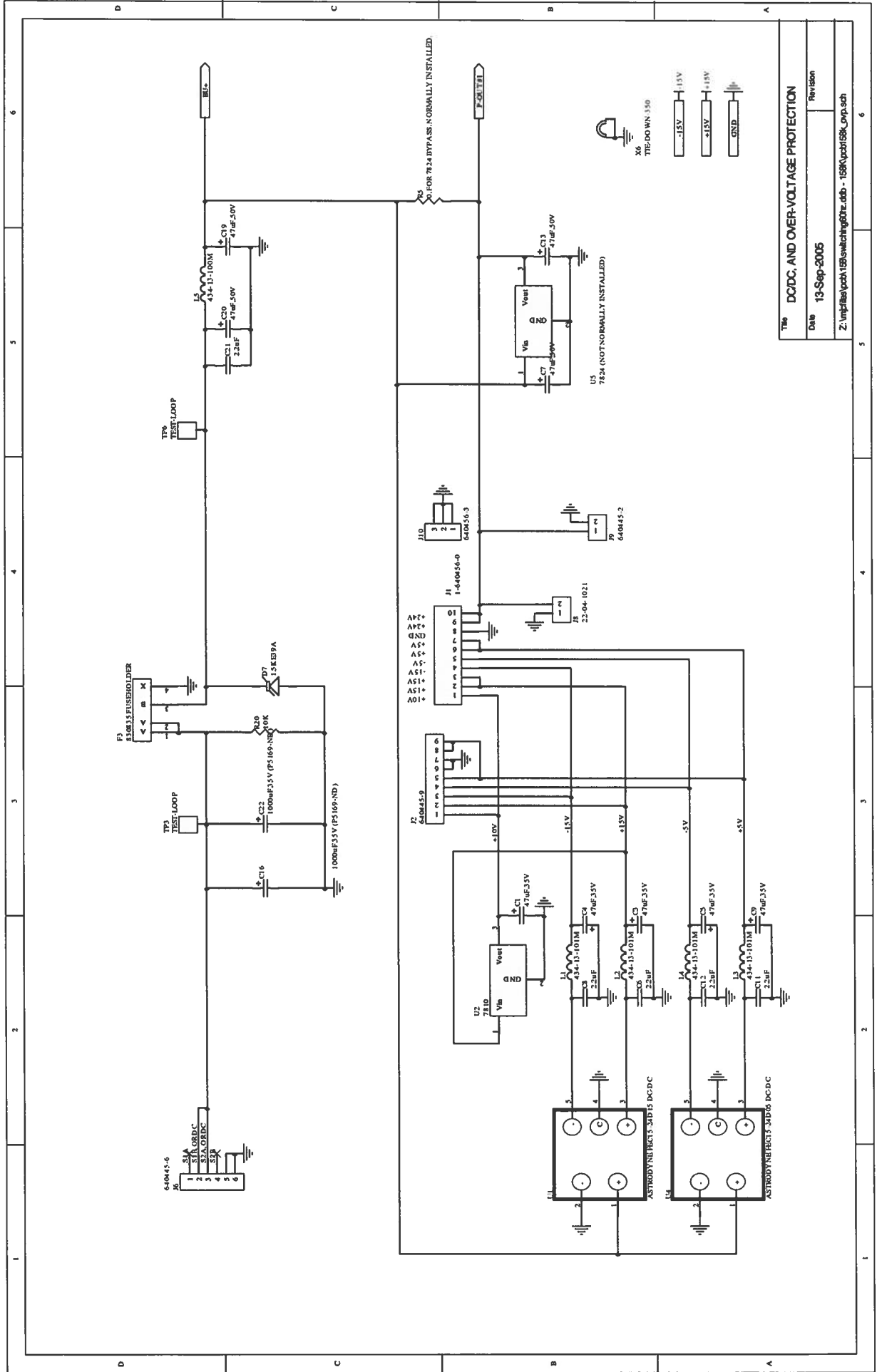

Title	DC/DC, AND OVER-VOLTAGE PROTECTION
Date	13-Sep-2005
Revision	
Z:\mp\lisa\pcb\158\switching02r.cdb - 158K\pcb\158K_dry.sch	

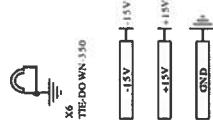

FOR 724 BTPA.SS. NORMALLY INSTALLED.

U3 724 (NOT NORMALLY INSTALLED)

J1 1-640456-0

J2 640455-9

U2 7310

U3 724 (NOT NORMALLY INSTALLED)



# PCB 168B - HIGH VOLTAGE DC POWER SUPPLY

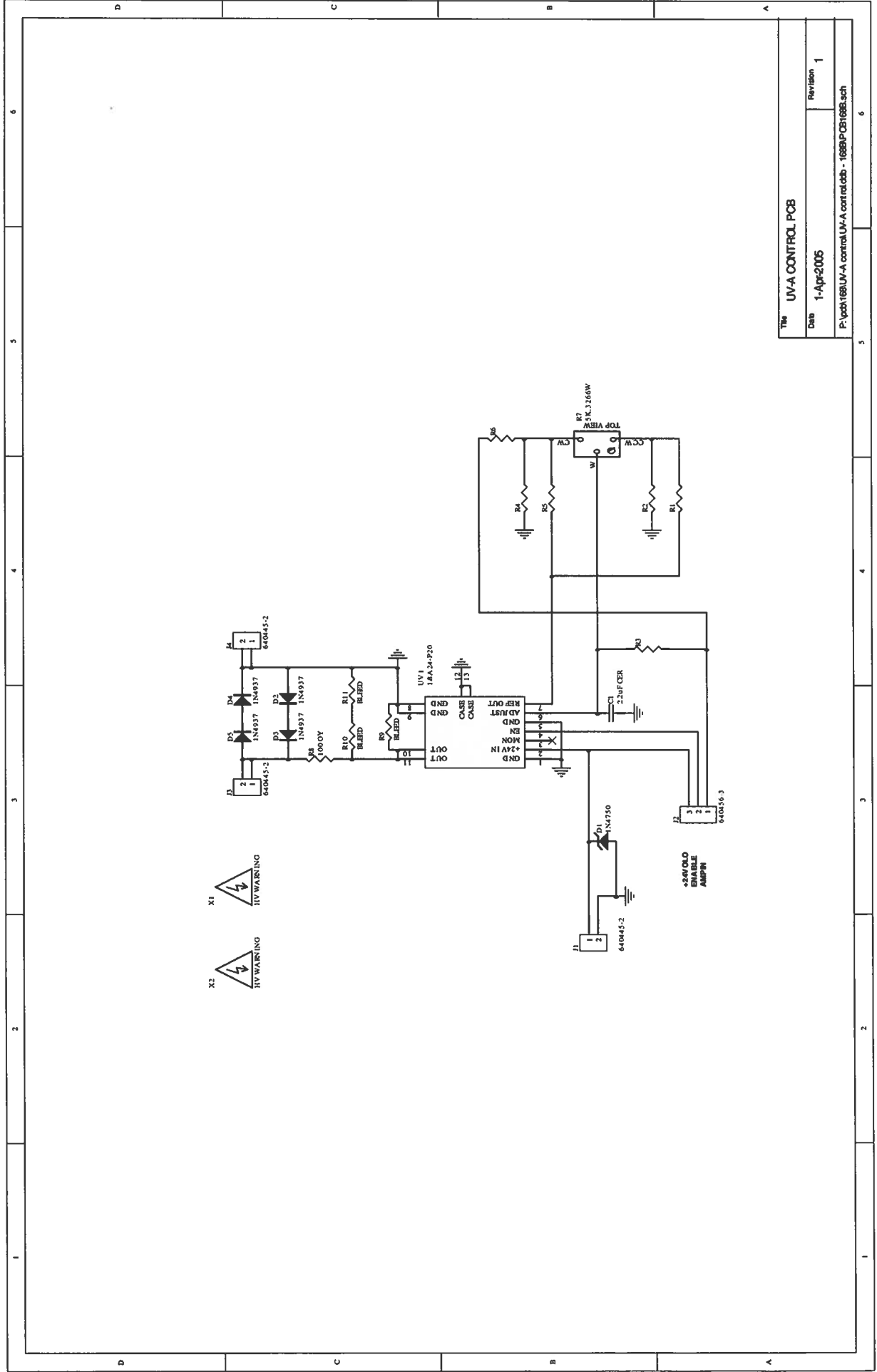

Title	UV-A CONTROL PCB
Date	1-Apr-2005
Revision	1
P:\pcb\168UV-A control UV-A control.cdb - 168B.PCB168B.sch	

# PCB 80B - TIMING BOARD (1/2)

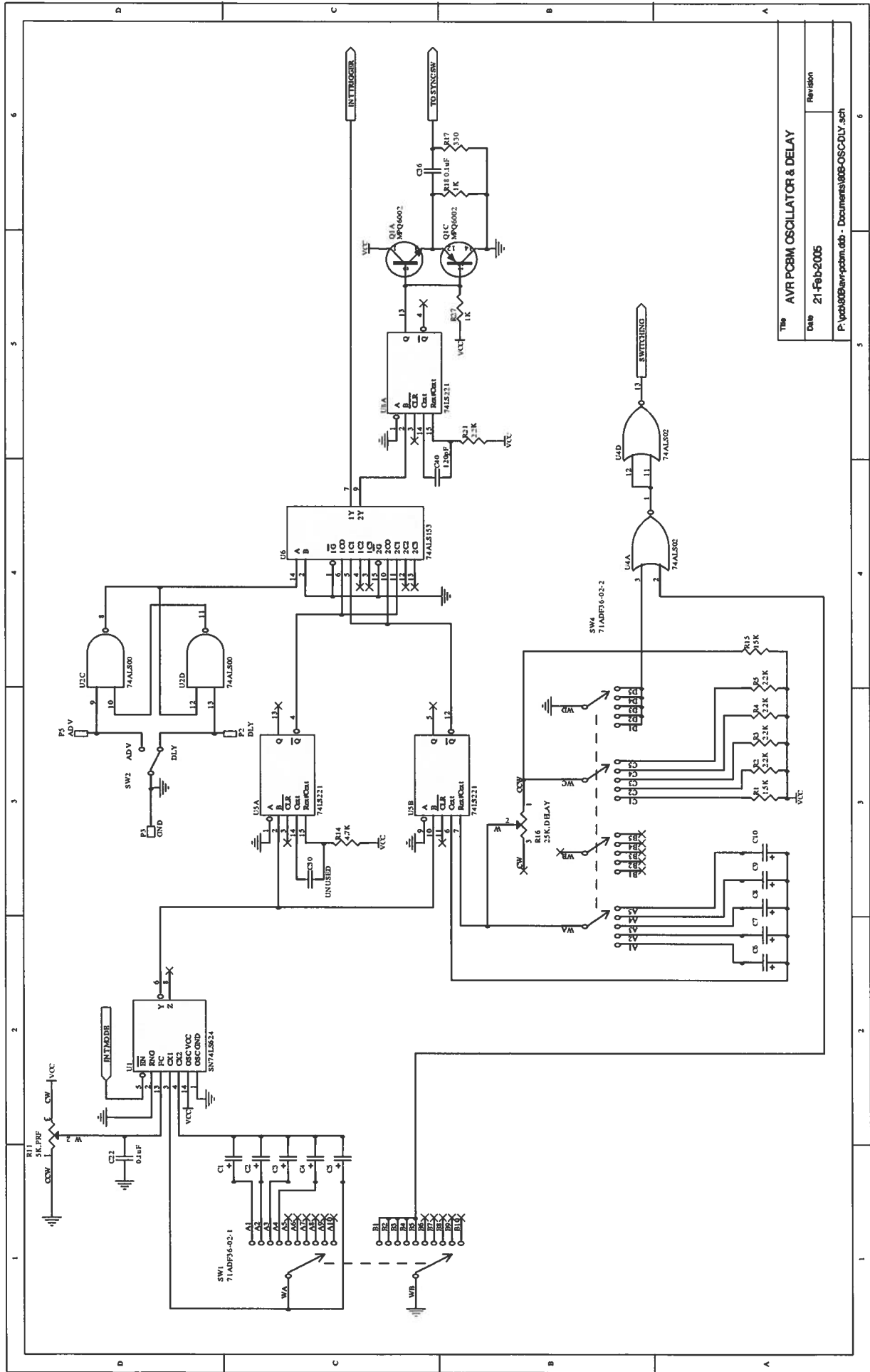

The AVR PCB8M OSCILLATOR & DELAY  
 Date 21-Feb-2005  
 Revision  
 P:\pcb8m\avr-pcbm.ddb - Documents\00B-OSCDLY.sch

# PCB 80B - TIMING BOARD (2/2)

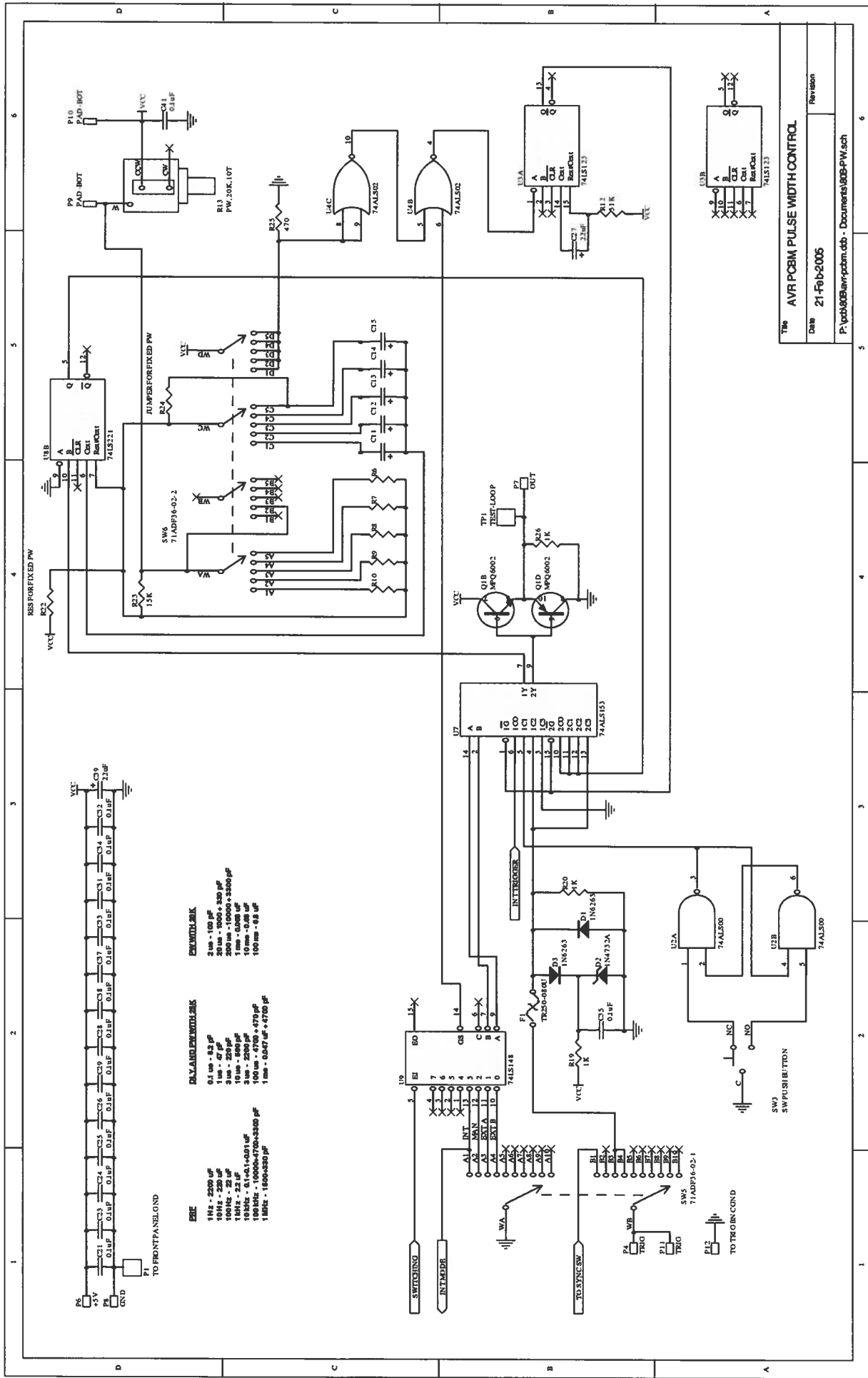

Title AVR PCB8M PULSE WIDTH CONTROL  
 Date 21-Feb-2005  
 Revision  
 P:\proj80B\avr-pcbm.dbb - Document\80B-PW.sch

# MAIN WIRING - TIMING CONTROL

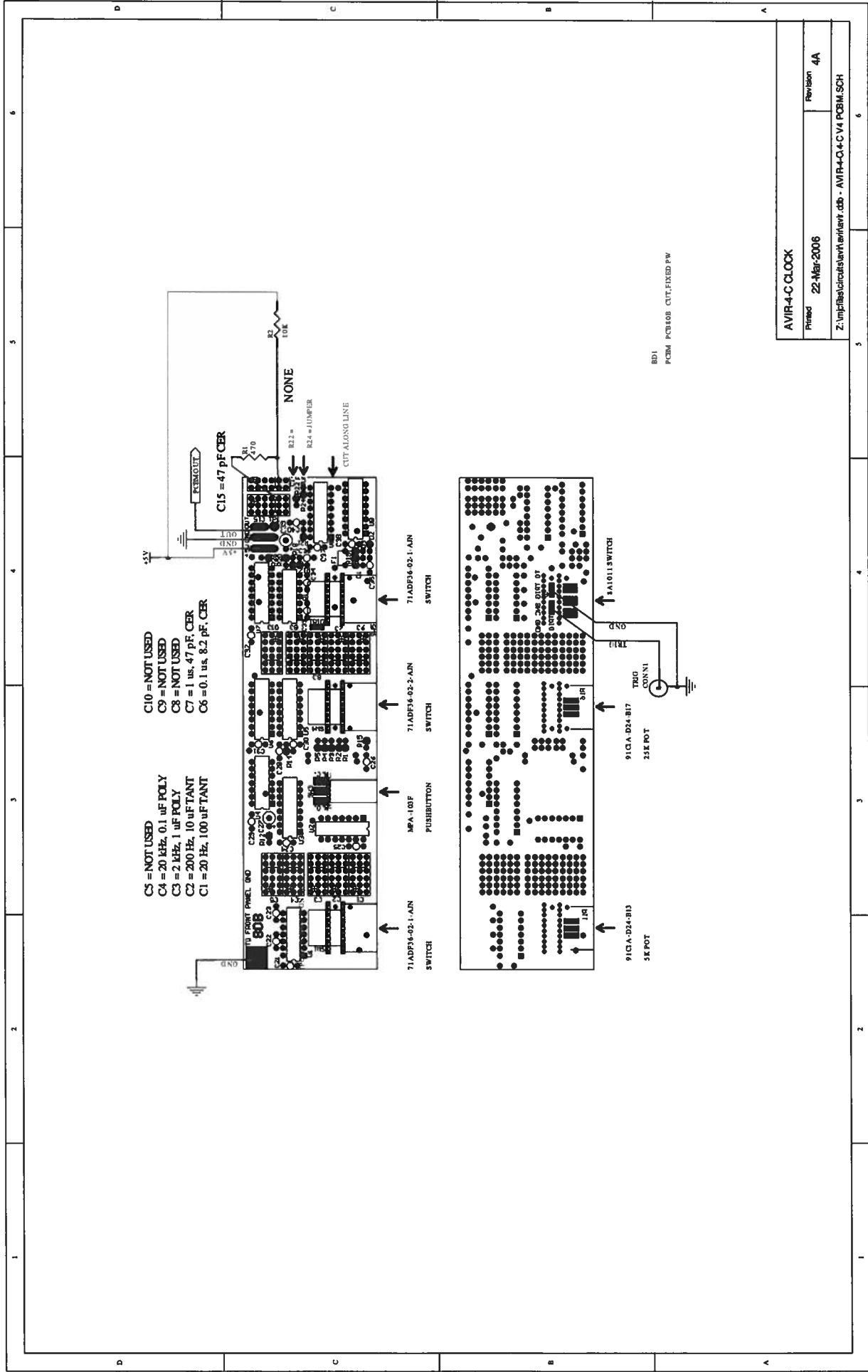

# MAIN WIRING

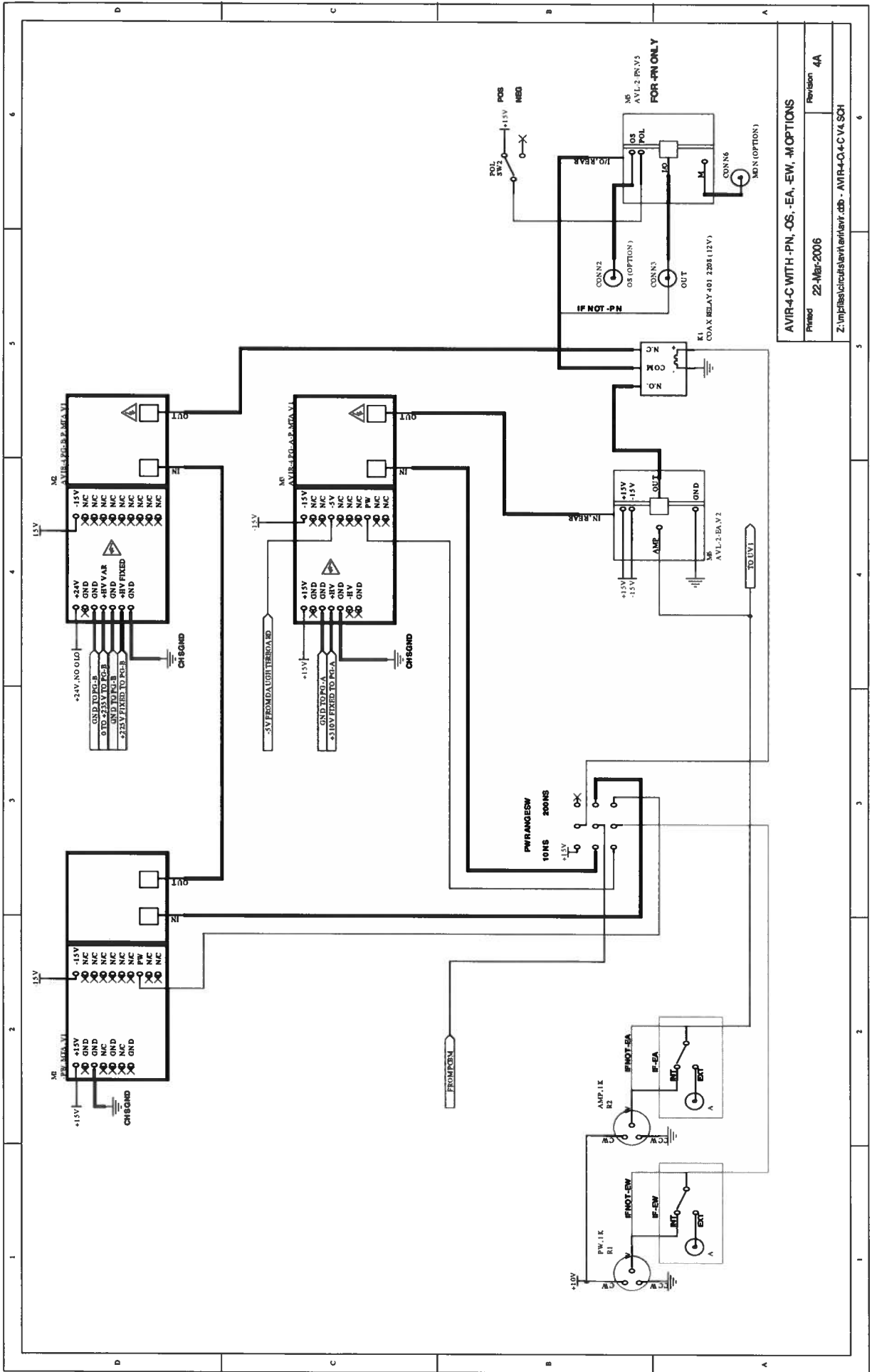

AVIR-4-C WITH -PN, -OS, -EA, -EW, -M OPTIONS

Printed 22-Mar-2006 Revision 4A

Z:\mp\basic\cslaw\avr4c.dwg - AVIR-4-C V4 SCH



March 22/06