



AVTECH ELECTROSYSTEMS LTD.

NANOSECOND WAVEFORM ELECTRONICS
SINCE 1975

□ P.O. BOX 265
OGDENSBURG, NY
U.S.A. 13669-0265
TEL: (315) 472-5270
FAX: (613) 226-2802

TEL: 1-800-265-6681
FAX: 1-800-561-1970
e-mail: info@avtechpulse.com
<http://www.avtechpulse.com>

□ P.O. BOX 5120 STN. F
OTTAWA, ONTARIO
CANADA K2C 3H4
TEL: (613) 226-5772
FAX: (613) 226-2802

INSTRUCTIONS

MODEL AVL-3A-C

0 TO 300 VOLTS, 5 kHz

HIGH SPEED PULSE GENERATOR

WITH 600 ps RISE TIME, 3 ns FALL TIME

SERIAL NUMBER: _____

WARRANTY

Avtech Electrosystems Ltd. warrants products of its manufacture to be free from defects in material and workmanship under conditions of normal use. If, within one year after delivery to the original owner, and after prepaid return by the original owner, this Avtech product is found to be defective, Avtech shall at its option repair or replace said defective item. This warranty does not apply to units which have been disassembled, modified or subjected to conditions exceeding the applicable specifications or ratings. This warranty is the extent of the obligation assumed by Avtech with respect to this product and no other warranty or guarantee is either expressed or implied.

TECHNICAL SUPPORT

Phone: 613-226-5772 or 1-800-265-6681

Fax: 613-226-2802 or 1-800-561-1970

E-mail: info@avtechpulse.com

World Wide Web: <http://www.avtechpulse.com>

TABLE OF CONTENTS

WARRANTY	2
TECHNICAL SUPPORT	2
TABLE OF CONTENTS	3
INTRODUCTION	4
AVAILABLE OPTIONS	4
SPECIFICATIONS	5
INSTALLATION	6
VISUAL CHECK	6
PLUGGING IN THE INSTRUMENT	6
FRONT PANEL CONTROLS	8
GENERAL INFORMATION	11
BASIC TEST ARRANGEMENT	11
BASIC PULSE CONTROL	11
GENERATING NEGATIVE OUTPUTS	13
MINIMIZING WAVEFORM DISTORTIONS	14
USE 50Ω TRANSMISSION LINES AND LOADS	14
USE LOW-INDUCTANCE LOADS	14
PREVENTING DAMAGE	14
OPTIONS	15
-OS OPTION	15
-M OPTION	15
MECHANICAL INFORMATION	16
TOP COVER REMOVAL	16
ELECTROMAGNETIC INTERFERENCE	16
PERFORMANCE CHECK SHEET	17

INTRODUCTION

The AVL-3A-C is a high performance instrument capable of generating up to +300V into 50 Ω loads at repetition rates up to 5 kHz. The output pulse width is variable from 5 to 100 ns, and the sync delay is variable up to ± 200 ns. The rise time is less than 600 ns, and the fall time is 3 ns.

The output is designed to drive 50 Ω loads. (A 50 Ω load is required for proper operation.) The output is AC-coupled.

AVAILABLE OPTIONS

The AVL-3A-C is available with several options:

"-OS" Option: an externally generated DC offset can be added to the output.

"-M" Option: a monitor output is provided.

SPECIFICATIONS

Model:	AVL-3A-C ¹
Amplitude ^{2,3} : (50 Ohm load)	0 to 300 Volts
Rise time ⁴ :	< 600 ps
Fall time:	< 3 ns
Pulse width ² :	5 to 100 ns
PRF:	0 to 5 kHz
Polarity ⁵ :	Positive (For negative output see Note 5.)
Propagation delay:	< 350 ns standard (100 ns optional ⁶). (Ext trig in to pulse out)
Jitter:	± 100 ps (Ext trig in to pulse out)
DC offset or bias insertion:	Option available. Apply required DC offset or bias in the range of ± 50 Volts, (250 mA max) to back panel solder terminal. See note 7.
Trigger required:	Ext trig mode: + 5 Volt, 50 to 500 ns (TTL)
Sync delay:	Sync out to pulse out: Variable 0 to 200 ns
Sync output:	+2 Volts, 200 ns, will drive 50 Ohm loads
Monitor output option ⁸ :	Provides a 20 dB attenuated coincident replica of main output
Connectors:	Out: SMA, Trig: BNC, Sync: BNC, Monitor: SMA
Dimensions: (H x W x D)	100 mm x 215 mm x 375 mm (3.9" x 8.5" x 14.8")
Other:	For power requirements, chassis material, mounting, and temperature range, see the AVL-2 data sheet, page 36.

- 1) -C suffix indicates stand-alone lab instrument with internal clock and line powering. For electronic control (0 to +10V) of amplitude, suffix model number with -EA. Electronic control units also include the standard front-panel one-turn controls. Available for AVL-3B-C only.
- 2) For operation at amplitudes of less than 10% of full-scale, best results will be obtained by setting the amplitude near full-scale and using external attenuators on the output.
- 3) For rise time variable up to 10 ns in ns increments via a ten-position switch suffix model number with -T. Not available for AVL-3A-C.
- 4) To obtain a negative output use Models AVX-1 or AVX-3 inverting transformer (see page 100).
- 5) For 100 ns propagation delay option, add suffix -TN. Not available for AVL-3A-C.
- 6) For DC offset option suffix model number with -OS.
- 7) For monitor option add suffix -M.

INSTALLATION

VISUAL CHECK

After unpacking the instrument, examine to ensure that it has not been damaged in shipment. Visually inspect all connectors, knobs, and handles. Confirm that a power cord is with the instrument. If the instrument has been damaged, file a claim immediately with the company that transported the instrument.

PLUGGING IN THE INSTRUMENT

Examine the rear of the instrument. There will be a male power receptacle, a fuse holder and the edge of the power selector card visible. Confirm that the power selector card is in the correct orientation.

For AC line voltages of 110-120V, the power selector card should be installed so that the "120" marking is visible from the rear of the instrument, as shown below:

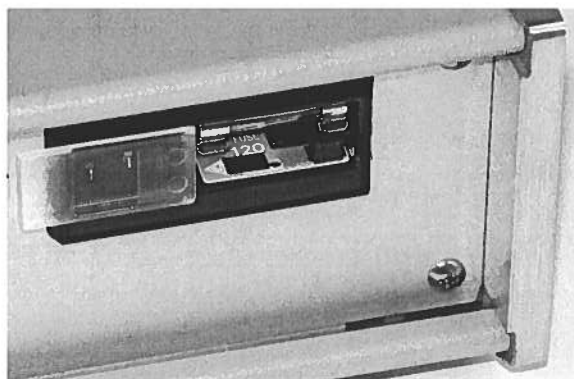

For AC line voltages of 220-240V, the power selector card should be installed so that the "240" marking is visible from the rear of the instrument, as shown below:

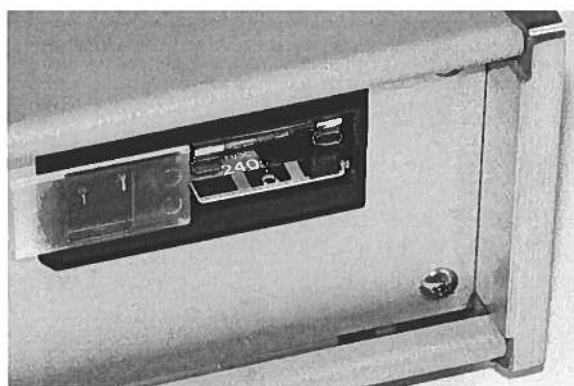

If it is not set for the proper voltage, remove the fuse and then grasp the card with a pair of pliers and remove it. Rotate horizontally through 180 degrees. Reinstall the card and the correct fuse.

In the 120V setting, a 0.5A slow blow fuse is required. In the 240V setting, a 0.25A slow blow fuse is required.

FRONT PANEL CONTROLS

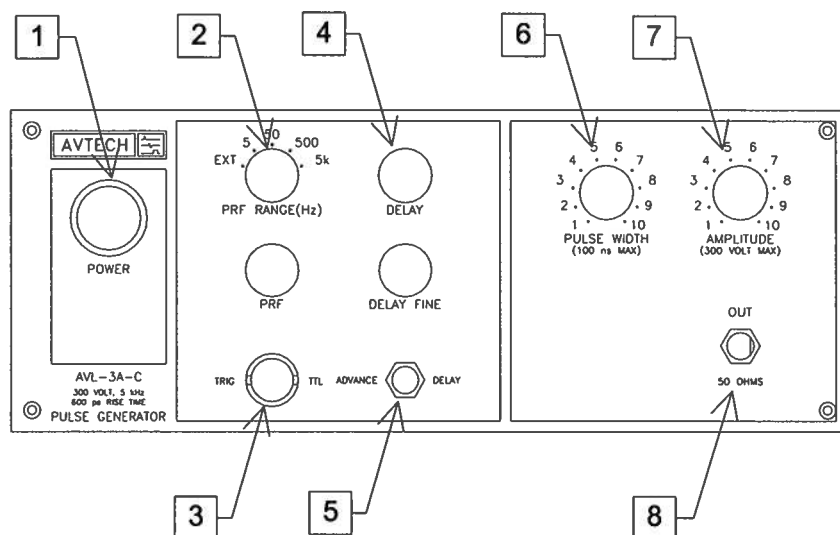

1. **POWER Switch.** The POWER push button switch applies AC prime power to the primaries of the transformer, turning the instrument on. The push button lamp is connected to the internal +15V DC supply.
2. **PRF Range Switch.** This switch sets the pulse repetition frequency (PRF) range of the internal oscillator. The marked value of each position is the upper limit of the 10:1 range, approximately. The vernier dial directly below the switch varies the PRF within the set range.

If this switch is set to the "EXT" position, the instrument is triggered by a signal applied to the TRIG connector, rather than by the internal oscillator.

3. **TRIG Connector.** When the PRF Range Switch is set to "EXT", the instrument is triggered by a TTL pulse applied to this connector. The pulse must be at least 50 ns wide.

When the PRF Range Switch is set to one of the four internal oscillator ranges, this connector is an output, which supplies a 2V, 200 ns wide pulse for each trigger event. This output may be used to trigger oscilloscopes or other equipment.

4. **Delay Controls.** When the PRF Range Switch is set to one of the four internal oscillator ranges, the main output is advanced or delayed relative to the TRIG output pulse (item 3). The delay is variable up to 200 ns, approximately, using the DELAY and DELAY FINE dials.

5. Advance/Delay Switch. When the PRF Range Switch is set to one of the four internal oscillator ranges, this switch determines whether the TRIG output precedes the main output (ADVANCE mode), or whether the TRIG output occur after the main output (DELAY mode).
6. Pulse Width Control. This dial controls the pulse width.
7. Amplitude Control. This dial controls the pulse amplitude.
8. OUT Connector. This is the main output. (This output *requires* a 50 Ω load to function properly).

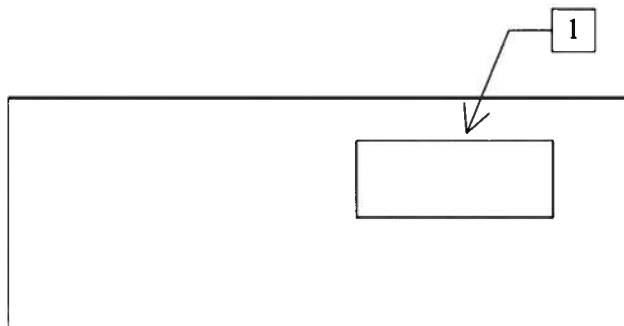

1. **AC POWER INPUT.** A three-pronged recessed male connector is provided on the back panel for AC power connection to the instrument. Also contained in this assembly is a slow-blow fuse and a removable card that can be removed and repositioned to switch between 120V AC in and 240V AC in.

For AC line voltages of 110-120V, the power selector card should be installed so that the “120” marking is visible from the rear of the instrument.

For AC line voltages of 220-240V, the power selector card should be installed so that the “240” marking is visible from the rear of the instrument.

If it is not set for the proper voltage, remove the fuse and then grasp the card with a pair of pliers and remove it. Rotate horizontally through 180 degrees. Reinstall the card and the correct fuse.

In the 120V setting, a 0.5A slow blow fuse is required. In the 240V setting, a 0.25A slow blow fuse is required. See the “Installation” section for more details.

GENERAL INFORMATION

BASIC TEST ARRANGEMENT

The AVL-3A-C should be tested with a sampling oscilloscope with a bandwidth of at least 5 GHz to properly observe the high-speed waveform. A typical test arrangement is shown below:

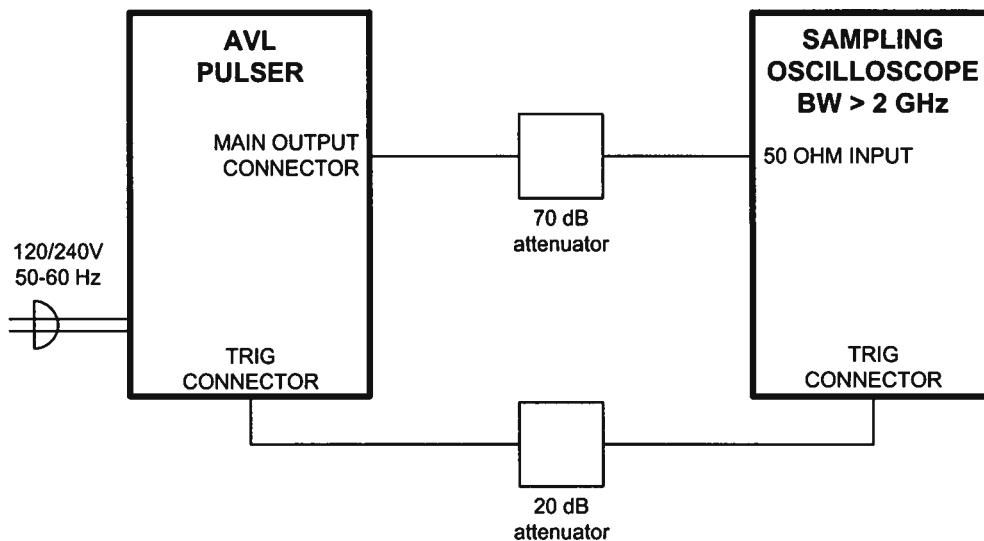

ALL CABLES: 50 OHM COAXIAL

The attenuators are required to prevent damage to the sampling oscilloscope. A 70 dB attenuator with sufficient voltage rating should be used on the main output.

BASIC PULSE CONTROL

This instrument can be triggered by its own internal clock or by an external TTL trigger signal. When triggered internally, two mainframe output channels respond to the trigger: OUT and SYNC.

- OUT. This is the main output. The maximum output voltage is +300V.
- TRIG. The TRIG pulse is a fixed-width TTL-level reference pulse used to trigger oscilloscopes or other measurement systems.

When the ADVANCE/DELAY switch is set to "ADVANCE", the TRIG output precedes the main output. These pulses are illustrated below:

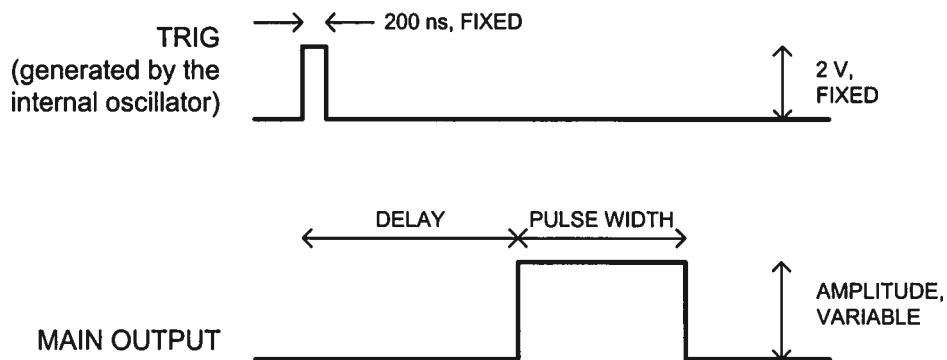
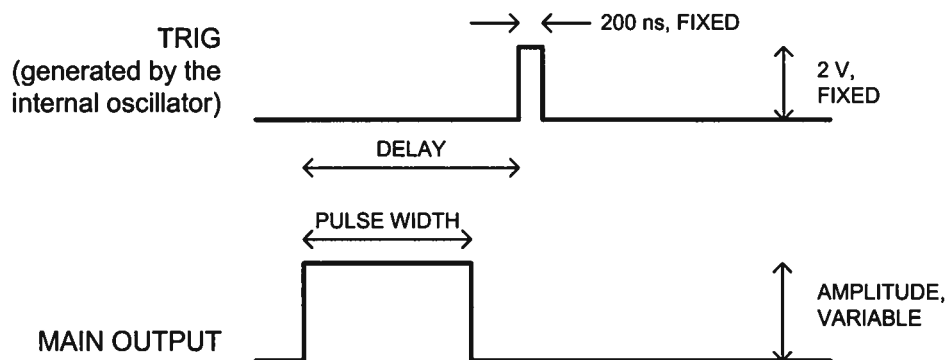
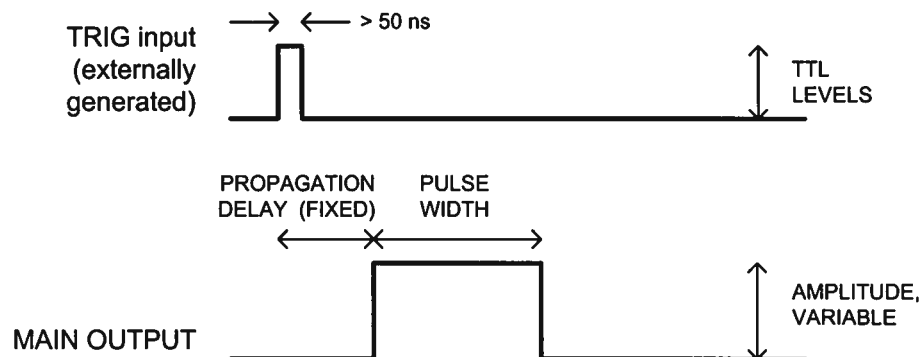

Figure A

When the ADVANCE/DELAY switch is set to "DELAY", the TRIG output occurs after the main output. This illustrated below:



When triggered externally, the TRIG connector acts as an input. The delay controls do not function in this mode. Figure C illustrates this mode:



GENERATING NEGATIVE OUTPUTS

The standard model AVL-3A-C generates positive output amplitudes. To obtain negative output voltages, an Avtech AVX-1 accessory transformer (not normally supplied with the AVL-3A-C) can be connected on the output. See <http://www.avtechpulse.com/transformer/avx-1/> for more information.

MINIMIZING WAVEFORM DISTORTIONS

USE 50Ω TRANSMISSION LINES AND LOADS

Connect the load to the pulse generator with 50Ω transmission lines (e.g. RG-58 or RG-174 cable).

This instrument requires a 50Ω load for proper operation. It will not properly drive a high-impedance load.

The AVL-3A pulse generator can withstand an infinite VSWR on the output port.

USE LOW-INDUCTANCE LOADS

Lenz's Law predicts that for an inductive voltage spike will be generated when the current through an inductance changes. Specifically, $V_{\text{SPIKE}} = L \times dI_{\text{LOAD}}/dt$, where L is the inductance, I_{LOAD} is the load current change, and t is time. For this reason, it is important to keep any parasitic in the load low. This means keeping wiring short, and using low inductance components. In particular, wire-wound resistors should be avoided.

PREVENTING DAMAGE

The AVL-3A-C may fail if triggered at a PRF greater than 5 kHz.

The lifetime of the switching elements in the pulse generator module is proportional to the running time of the instrument. For this reason the prime power to the instrument should be turned off when the instrument is not in use.

OPTIONS

The AVL-3A-C is available with these options:

-OS OPTION

This option allows an externally generated DC offset to be added to the output. The desired DC offset is applied to the back panel OS terminal, which is connected to the output centre conductor through a high-quality RF inductor. Do not exceed 50V, 100 mA.

-M OPTION

This option provides a monitor output, which is an attenuated replica of the main output. The monitor is connected to the main output through a 470 Ohm resistor, which results in an attenuation of approximately 20 dB (i.e., $\div 10$) when the monitor output is terminated with a 50 Ohm load.

For models with the "-OS" option, the monitor output does not include the effect of the added offset.

The monitor output should be terminated with a 50 Ohm load.

MECHANICAL INFORMATION

TOP COVER REMOVAL

The interior of the instrument may be accessed by removing the four Phillips screws on the top panel. With the four screws removed, the top cover may be slid back (and off).

ELECTROMAGNETIC INTERFERENCE

To prevent electromagnetic interference with other equipment, all used outputs should be connected to shielded 50 Ω loads using shielded 50 Ω coaxial cables. Unused outputs should be terminated with shielded 50 Ω BNC terminators or with shielded BNC dust caps, to prevent unintentional electromagnetic radiation. All cords and cables should be less than 3m in length.

JUN 20, 2002 edc