



AVTECH ELECTROSYSTEMS LTD.

NANOSECOND WAVEFORM ELECTRONICS
SINCE 1975

P.O. BOX 265
OGDENSBURG, NY
U.S.A. 13669-0265
TEL: (315) 472-5270
FAX: (613) 226-2802

TEL: 1-800-265-6681
FAX: 1-800-561-1970

e-mail: info@avtechpulse.com
<http://www.avtechpulse.com>

P.O. BOX 5120 STN. F
OTTAWA, ONTARIO
CANADA K2C 3H4
TEL: (613) 226-5772
FAX: (613) 226-2802

INSTRUCTIONS

MODEL AVM-2-C-D-M-EA-EW-ED-EO-STA

0 TO 15 V, 25 MHz

DUAL-CHANNEL PULSE GENERATOR

SERIAL NUMBER: _____

WARRANTY

Avtech Electrosystems Ltd. warrants products of its manufacture to be free from defects in material and workmanship under conditions of normal use. If, within one year after delivery to the original owner, and after prepaid return by the original owner, this Avtech product is found to be defective, Avtech shall at its option repair or replace said defective item. This warranty does not apply to units which have been disassembled, modified or subjected to conditions exceeding the applicable specifications or ratings. This warranty is the extent of the obligation assumed by Avtech with respect to this product and no other warranty or guarantee is either expressed or implied.

TECHNICAL SUPPORT

Phone: 613-226-5772 or 1-800-265-6681

Fax: 613-226-2802 or 1-800-561-1970

E-mail: info@avtechpulse.com

World Wide Web: <http://www.avtechpulse.com>

TABLE OF CONTENTS

WARRANTY	2
TECHNICAL SUPPORT	2
TABLE OF CONTENTS	3
INTRODUCTION	4
ORIGINAL QUOTATION	4
OTHER SPECIFICATIONS	5
VISUAL CHECK	6
PLUGGING IN THE INSTRUMENT	6
FRONT PANEL CONTROLS	8
REAR PANEL CONTROLS	10
GENERAL INFORMATION	12
BASIC PULSE CONTROL	12
OTHER NOTES	12
TOP COVER REMOVAL	13
RACK MOUNTING	13
ELECTROMAGNETIC INTERFERENCE	13
POWER SUPPLY AND FUSE REPLACEMENT	14
PERFORMANCE CHECK SHEET	16

INTRODUCTION

The Avtech AVM-2-C-D-M-EA-EW-ED-EO-STA is a special-purpose high-speed dual-channel pulse generator, capable of generating pulses with amplitudes to $\pm 15V$, with pulse widths from 0.2 to 2.0 ns, at repetition rates to 25 MHz.

Two main outputs are provided. One generates a positive voltage pulse, and the other generates a negative voltage pulse. The two outputs have independent pulse width, amplitude, and delay controls. They share a common trigger source.

ORIGINAL QUOTATION

Quote number: 10916

Base model: AVM-2-C, \$3793

Available options:

- ED: Electronic delay control (analog), \$410.
- EW: Electronic PW control (analog), \$410.
- EO: Internally generated offset option, \$819.
- D: Delay option, \$328.
- M: Monitor, \$328.
- EA: Electronic amplitude control (analog), \$410.
- STA: Dual polarity with two output connectors (one positive output, one negative output, both are active simultaneously, with independent pulse width, amplitude, and delay controls, and a common trigger source), \$1898.

Terms: 60 day delivery, Ex-works Ottawa, Canada.

The total cost with all of the above options is \$8396. The complete model number is AVM-2-C-D-M-EA-EW-ED-EO-STA.

Note: The quoted unit is a very high performance pulse generator, which is considered to be "Nuclear-Related Dual-Use Goods" under government regulations. As such, an "End Use Statement" must be completed when you place the order. The necessary form is attached (in Microsoft Word format). We will use the information in the completed form to apply for an export license from the Canadian government, which will take 1 to 6 weeks to obtain. We cannot ship your order without the license.

Please call or email me if I can be of further assistance.

Regards,
Dr. Michael J. Chudobiak
VP, New Product Development

--- Avtech Electrosystems Ltd. ----- since 1975 ---

PO Box 265	ph: 1-800-265-6681 or 613-226-5772	Box 5120 Stn. F
Ogdensburg, NY	fax: 1-800-561-1970 or 613-226-2802	Ottawa, Ontario
USA 13669-0265	email: info@avtechpulse.com	Canada K2C 3H4
	http://www.avtechpulse.com/	

Nanosecond Waveform Generators
for general purpose, R&D and OEM applications

Pulse Generators - Laser Diode Drivers - Pulse Amplifiers
Impulse Generators - Delay Generators - Comb Generators - Splitters
Function Generators - Monocycle Generators - Frequency Dividers + more!

OTHER SPECIFICATIONS

Model:	AVM-2-C ¹			
Amplitude ³ : (50 Ohm load)	Variable to 15 Volts			
Pulse width ² :	Variable 0.2 to 2.0 ns			
PRF:	0 to 25 MHz (-C units & modules, externally triggered) 3 kHz to 25 MHz (-C units, internally triggered)			
Rise time:	≤ 100 ps			
Fall time:	≤ 135 ps (typically 100 ps)			
Polarity ⁴ :	Positive or negative or both (specify)			
Propagation delay:	≤ 30 ns (Ext trig in to pulse out)			
Variable propagation delay option ⁵ :	0 to 5 ns			
Jitter:	± 15 ps (Ext trig in to pulse out)			
DC offset or bias insertion ⁶ :	Apply required DC offset to back panel solder terminals (± 50 Volts, 250 mA max)			
Trigger required:	Modules, and -C ext trig mode: +5 Volts, 10 ns or wider (TTL)			
Sync delay:	Sync out to pulse out, -C units only: Variable 0 to 85 ns			
Sync output: (-C only)	+0.5 Volts, 20 ns, will drive 50 Ohm loads			
Monitor output option ⁷ :	Provides a 20 dB attenuated coincident replica of main output			
Connectors:	-C units:	Out: SMA,	Trig: BNC,	Sync: BNC,
	Modules:	Out: SMA,	In: SMA,	Monitor: SMA
				Power: Solder terminals

- 1) -C suffix indicates stand-alone lab instrument with internal clock and line powering. No suffix indicates miniature module requiring DC power and external trigger. (See page 112 for additional details of the basic instrument formats).
- 2,3,5,6) For electronic control (0 to +10V) of amplitude, pulse width, delay or offset suffix model number with -EA or -EW or -ED or -EO. Electronic control units also include standard front panel one-turn controls.
- 4) Indicate desired polarity by suffixing model number with -P or -N (i.e. positive or negative) or -P-PN or -N-PN for dual polarity option where the suffix preceding -PN indicates the polarity at the mainframe output port. (-PN available only for -C units).
- 5) Indicate delay option by suffixing model number with -D.
- 6) For internally generated DC offset option (0 to ±5 V, one turn control) add suffix -OT to model number. -OT and -EO options not available on modules.
- 7) For monitor option add suffix -M.

INSTALLATION

VISUAL CHECK

After unpacking the instrument, examine to ensure that it has not been damaged in shipment. Visually inspect all connectors, knobs, and handles. Confirm that a power cord is with the instrument. If the instrument has been damaged, file a claim immediately with the company that transported the instrument.

PLUGGING IN THE INSTRUMENT

Examine the rear of the instrument. There will be a male power receptacle, a fuse holder and the edge of the power selector card visible. Confirm that the power selector card is in the correct orientation.

For AC line voltages of 110-120V, the power selector card should be installed so that the "120" marking is visible from the rear of the instrument, as shown below:

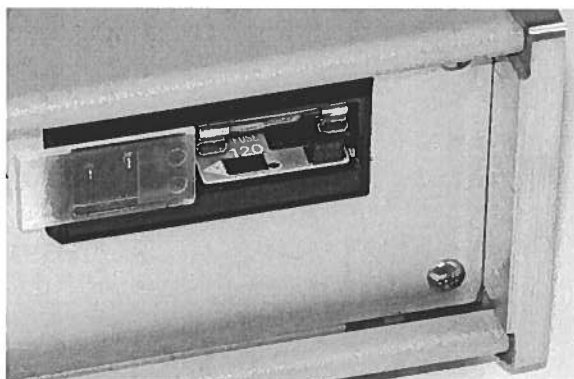

For AC line voltages of 220-240V, the power selector card should be installed so that the "240" marking is visible from the rear of the instrument, as shown below:

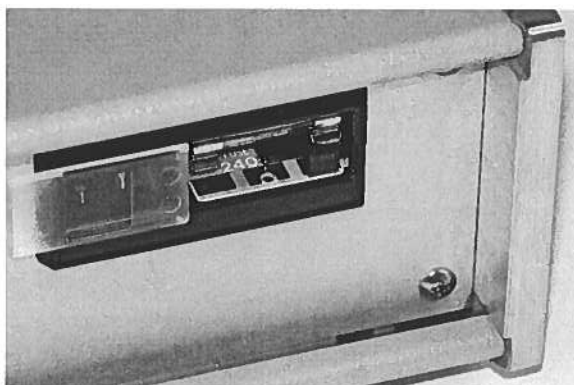



If it is not set for the proper voltage, remove the fuse and then grasp the card with a pair of pliers and remove it. Rotate horizontally through 180 degrees. Reinstall the card and the correct fuse.

In the 120V setting, a 1.0A slow blow fuse is required. In the 240V setting, a 0.5A slow blow fuse is required.

FRONT PANEL CONTROLS

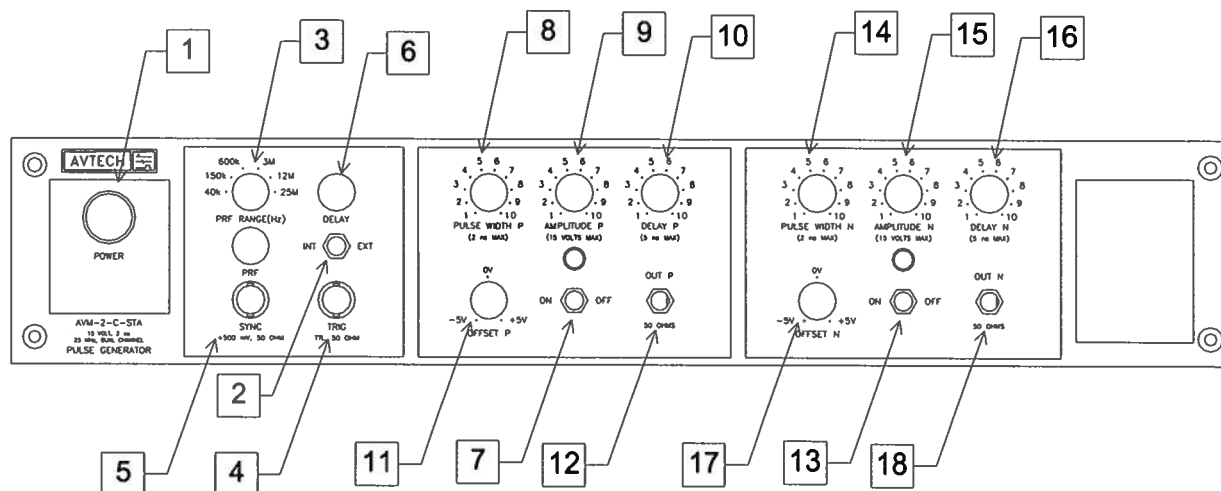

1. **POWER Switch.** The POWER push button switch applies AC prime power to the primaries of the transformer, turning the instrument on. The push button lamp (#382 type) is connected to the internal +15V DC supply.
2. **INT/EXT Switch.** In the "INT" position the instrument is internally triggered and the "SYNC OUT" connector provides a SYNC output which allows one to trigger other instruments, such as oscilloscopes. In the "EXT" position the instrument is triggered by a +5 Volt 10 ns (or wider) input pulse on the "TRIG" connector.
3. **REPETITION RATE Controls.** The rotary switch marked "RANGE" selects the pulse repetition rate for the internally triggered mode. The vernier (labelled "FINE") provides continuously variable control of each range. There are five ranges and the instrument is set to the rate indicated on the front panel when the vernier is in the clockwise position.
4. **TRIG Connector.** When the INT/EXT switch (item 2) is set to the "EXT" position, a TTL-level pulse (> 10 ns) applied to this input will trigger the instrument. The instrument triggers on the rising edge of this input. The input impedance of this input is 50Ω .
5. **SYNC OUT Connector.** This output generates a 20 ns wide, +500 mV pulse for each internal trigger event. This output can be used to trigger an oscilloscope, or other test equipment.
6. **DELAY Control.** This one-turn knob controls the separation between the main output and the SYNC OUT output (item 5). This delay is common to both outputs.

7. "P" On/Off Switch. This switch enables/disables the "P" output. The indicator light above the switch is illuminated when this switch is in the "ON" position.
8. Pulse Width P. When the rear-panel "PW P" switch is in the "INT" position, this one-turn knob varies the "P" output pulse width from 0.2 to 2 ns.
9. Amplitude P. When the rear-panel "AMP P" switch is in the "INT" position, this one-turn knob varies the "P" output amplitude from 0 to +15V.
10. Delay P. When the rear-panel "DELAY P" switch is in the "INT" position, this one-turn knob varies the delay of the "P" output pulse over a 5 ns range.
11. Offset P. When the rear-panel "OFFSET P" switch is in the "INT" position, this one-turn knob varies the offset of the "P" output pulse over a $\pm 5V$ range. The rear-panel "OT P" switch must be set to "ON" for this function to be enabled.
12. OUT P Connector. This is the "P" (positive) output. A 50 Ohm load is required.
13. "N" On/Off Switch. This switch enables/disables the "N" output. The indicator light above the switch is illuminated when this switch is in the "ON" position.
14. Pulse Width N. When the rear-panel "PW N" switch is in the "INT" position, this one-turn knob varies the "N" output pulse width from 0.2 to 2 ns.
15. Amplitude N. When the rear-panel "AMP N" switch is in the "INT" position, this one-turn knob varies the "N" output amplitude from 0 to +15V.
16. Delay N. When the rear-panel "DELAY N" switch is in the "INT" position, this one-turn knob varies the delay of the "N" output pulse over a 5 ns range.
17. Offset N. When the rear-panel "OFFSET N" switch is in the "INT" position, this one-turn knob varies the offset of the "N" output pulse over a $\pm 5V$ range. The rear-panel "OT N" switch must be set to "ON" for this function to be enabled.
18. OUT N Connector. This is the "N" (positive) output. A 50 Ohm load is required.

REAR PANEL CONTROLS

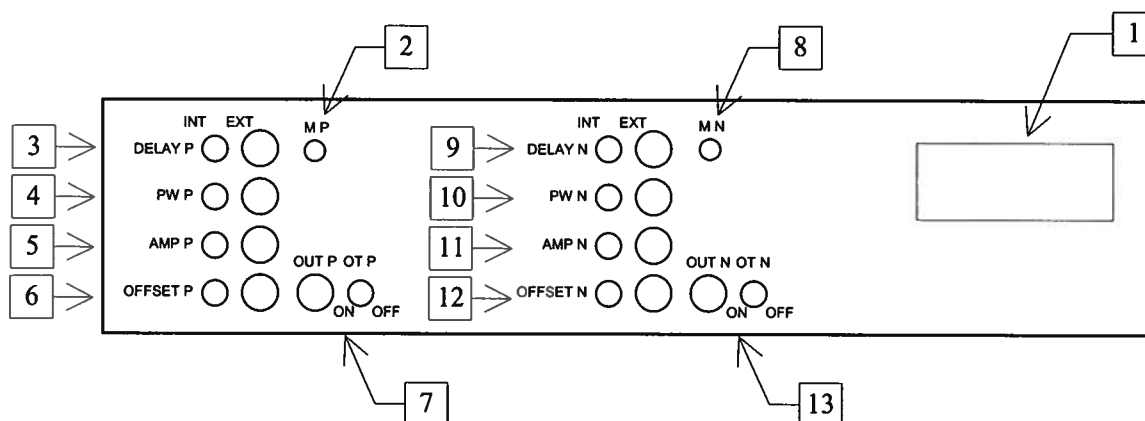

1. **AC POWER INPUT.** A three-pronged recessed male connector is provided on the back panel for AC power connection to the instrument. Also contained in this assembly is a slow blow fuse and a removable card that can be removed and repositioned to switch between 120V AC in and 240V AC in.

For AC line voltages of 110-120V, the power selector card should be installed so that the "120" marking is visible from the rear of the instrument.

For AC line voltages of 220-240V, the power selector card should be installed so that the "240" marking is visible from the rear of the instrument.

If it is not set for the proper voltage, remove the fuse and then grasp the card with a pair of pliers and remove it. Rotate horizontally through 180 degrees. Reinstall the card and the correct fuse.

In the 120V setting, a 1.0A slow blow fuse is required. In the 240V setting, a 0.5A slow blow fuse is required. See the "Installation" section for more details.

2. **MP Output.** Provides an attenuated (x10) coincident replica (to 50 ohm) of the "P" output.
3. **DELAY P Switch / Input.** To control the delay of the "P" output with an external DC voltage, set the two-position switch to the EXT position and apply 0 to +10V to the BNC Connector ($R_{IN} \geq 10 \text{ k}\Omega$). When this switch is in the "INT" position, the delay is controlled by the front-panel controls.
4. **PW P Switch / Input.** To control the pulse width of the "P" output with an external DC voltage, set the two-position switch to the EXT position and apply 0 to +10V to the BNC Connector ($R_{IN} \geq 10 \text{ k}\Omega$). When this switch is in the "INT" position, the pulse width is controlled by the front-panel controls.

5. AMP P Switch / Input. To control the amplitude of the “P” output with an external DC voltage, set the two-position switch to the EXT position and apply 0 to +10V to the BNC Connector ($R_{IN} \geq 10 \text{ k}\Omega$). When this switch is in the “INT” position, the amplitude is controlled by the front-panel controls.
6. OFFSET P Switch / Input. To control the DC offset of the “P” output with an external DC voltage, set the two-position switch to the EXT position and apply 0 to +10V to the BNC Connector ($R_{IN} \geq 10 \text{ k}\Omega$). When this switch is in the “EXT” position, the delay is controlled by the front-panel controls.
7. OT P Switch and OUT P Output. The OT P switch enables the front-panel “OFFSET P” control, when it is set to “ON”. When it is set to “OFF”, the offset control is disabled. The internally generated offset is available at the “OUT P” BNC connector, for monitoring purposes.
8. MN Output. Provides an attenuated (x10) coincident replica (to 50 ohm) of the “N” output.
9. DELAY N Switch / Input. To control the delay of the “N” output with an external DC voltage, set the two-position switch to the EXT position and apply 0 to +10V to the BNC Connector ($R_{IN} \geq 10 \text{ k}\Omega$). When this switch is in the “INT” position, the delay is controlled by the front-panel controls.
10. PW N Switch / Input. To control the pulse width of the “N” output with an external DC voltage, set the two-position switch to the EXT position and apply 0 to +10V to the BNC Connector ($R_{IN} \geq 10 \text{ k}\Omega$). When this switch is in the “INT” position, the pulse width is controlled by the front-panel controls.
11. AMP N Switch / Input. To control the amplitude of the “N” output with an external DC voltage, set the two-position switch to the EXT position and apply 0 to +10V to the BNC Connector ($R_{IN} \geq 10 \text{ k}\Omega$). When this switch is in the “INT” position, the amplitude is controlled by the front-panel controls.
12. OFFSET N Switch / Input. To control the DC offset of the “N” output with an external DC voltage, set the two-position switch to the EXT position and apply 0 to +10V to the BNC Connector ($R_{IN} \geq 10 \text{ k}\Omega$). When this switch is in the “EXT” position, the delay is controlled by the front-panel controls.
13. OT N Switch and OUT N Output. The OT N switch enables the front-panel “OFFSET N” control, when it is set to “ON”. When it is set to “OFF”, the offset control is disabled. The internally generated offset is available at the “OUT N” BNC connector, for monitoring purposes.

GENERAL INFORMATION

BASIC PULSE CONTROL

Each of the outputs drives a separate 50 Ohm load. A SYNC pulse and two main output pulses are generated for each trigger event (when triggered internally), as shown below:

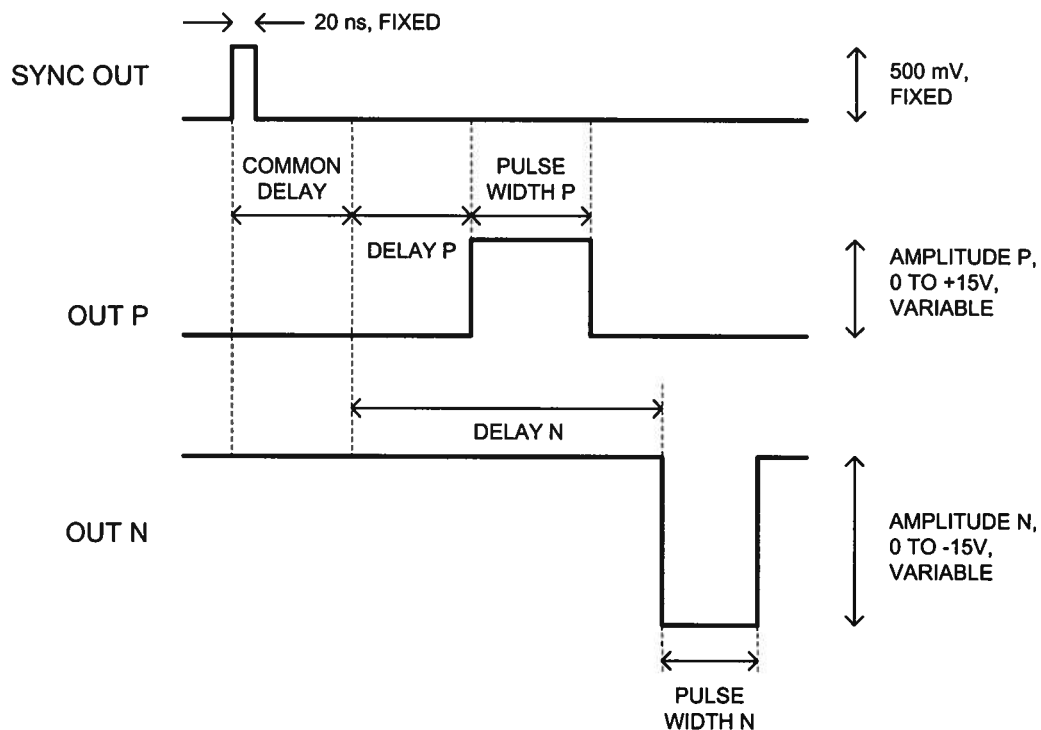

The pulse width, amplitude, and delay of each channel are independently variable. A variable common delay is also present. When triggered externally, the operation is similar, except that no SYNC pulse is generated.

OTHER NOTES

The amplitude and pulse width controls interact. When adjusting one, it may be necessary to adjust the other.

The bandwidth capability of components and instruments used to display the pulse generator output signals (attenuators, cables, connectors, etc.) should exceed 10 GHz.

The AVM-2-C-D-M-EA-EW-ED-EO-STA may fail if triggered at a PRF greater than 25 MHz.

The AVM-2-C-D-M-EA-EW-ED-EO-STA can withstand an infinite VSWR on the output port.

TOP COVER REMOVAL

The interior of the instrument may be accessed by removing the four Phillips screws on the top panel. With the four screws removed, the top cover may be slid back (and off).

RACK MOUNTING

A rack mounting kit is available. The -R5 rack mount kit may be installed after first removing the one Phillips screw on the side panel adjacent to the front handle.

ELECTROMAGNETIC INTERFERENCE

To prevent electromagnetic interference with other equipment, all used outputs should be connected to shielded 50 Ω loads using shielded 50 Ω coaxial cables. Unused outputs should be terminated with shielded 50 Ω BNC terminators or with shielded BNC dust caps, to prevent unintentional electromagnetic radiation. All cords and cables should be less than 3m in length.

POWER SUPPLY AND FUSE REPLACEMENT

This instrument has three main fuses, plus two spares. One, which protects the AC input, is located in the rear-panel power entry module, as described in the “Rear Panel Controls” section of this manual. If the power appears to have failed, check the AC fuse first.

The other two fuses (plus two spares) are located on the internal DC power supply, as shown below:

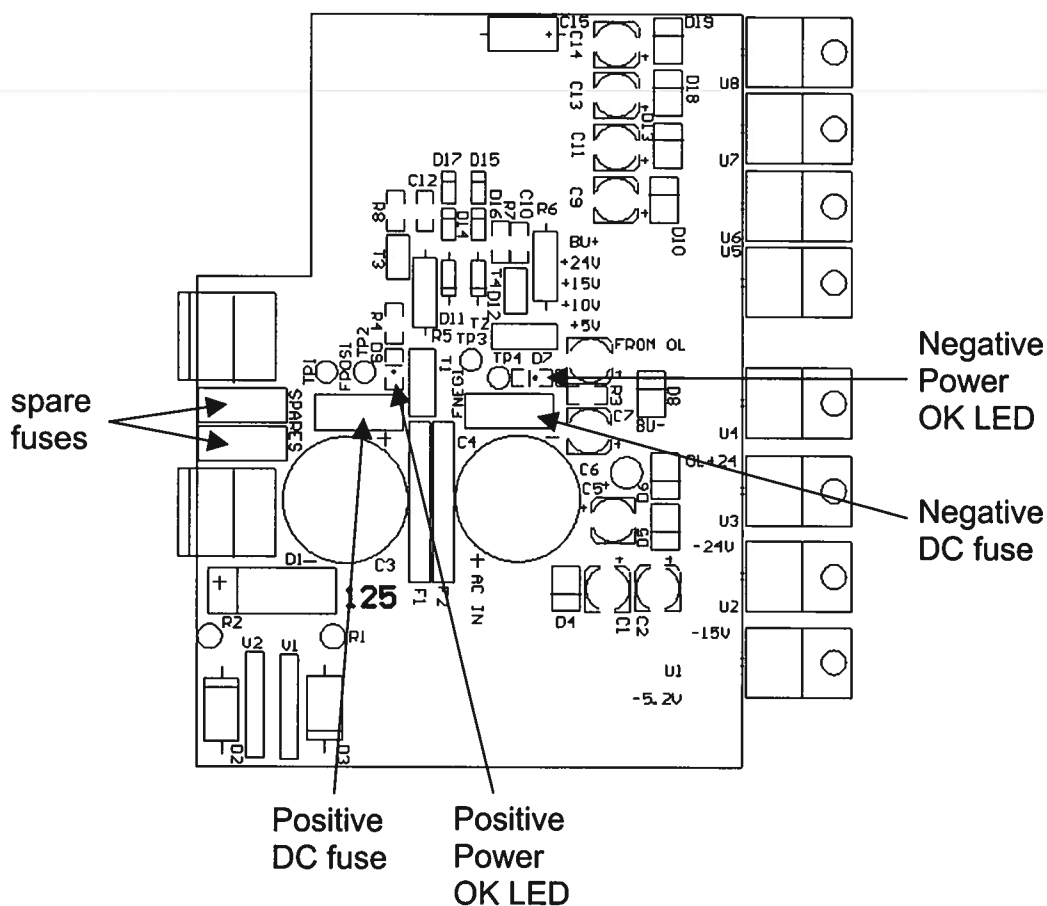

The positive fuse and one of the spare fuses on this circuit board are 2A slow-blow fuses, Littlefuse part number R452002. (This fuse can be ordered from Digikey, www.digikey.com. The Digikey part number is F1345CT-ND). The negative fuse and the second spare fuse are 1A slow-blow fuses (Littlefuse R452001, Digikey part number F1343CT-ND).

If you suspect that the DC fuses are blown, follow this procedure:

1. Remove the top cover, by removing the four Phillips screws on the top cover and then sliding the cover back and off.

2. Locate the two "Power OK" LEDs on the power supply circuit board, as illustrated above.
3. Turn on the instrument.
4. Observe the "Power OK" LEDs. If the fuses are not blown, the two LEDs will be lit (bright red). If one of the LEDs is not lit, the fuse next to it has blown.
5. Turn off the instrument.
6. If a fuse is blown, use needle-nose pliers to remove the blown fuse from its surface-mount holder.
7. Replace the fuse. (Spare 2 Amp and 1 Amp fuses are provided on the circuit board. They may be transferred to the active fuse locations using needle-nose pliers.)

July 11, 2002

2