



AVTECH ELECTROSYSTEMS LTD.

NANOSECOND WAVEFORM ELECTRONICS
SINCE 1975

P.O. BOX 265
OGDENSBURG, NY
U.S.A. 13669-0265
TEL: (315) 472-5270
FAX: (613) 226-2802

TEL: 1-800-265-6681
FAX: 1-800-561-1970

e-mail: info@avtechpulse.com
<http://www.avtechpulse.com>

P.O. BOX 5120 STN. F
OTTAWA, ONTARIO
CANADA K2C 3H4
TEL: (613) 226-5772
FAX: (613) 226-2802

INSTRUCTIONS

AVNN SERIES

25 MHz TO 250 MHz

HIGH SPEED PULSE GENERATOR

WITH 100 ps RISE & FALL TIMES

SERIAL NUMBER: _____

WARRANTY

Avtech Electrosystems Ltd. warrants products of its manufacture to be free from defects in material and workmanship under conditions of normal use. If, within one year after delivery to the original owner, and after prepaid return by the original owner, this Avtech product is found to be defective, Avtech shall at its option repair or replace said defective item. This warranty does not apply to units which have been disassembled, modified or subjected to conditions exceeding the applicable specifications or ratings. This warranty is the extent of the obligation assumed by Avtech with respect to this product and no other warranty or guarantee is either expressed or implied.

TECHNICAL SUPPORT

Phone: 613-226-5772 or 1-800-265-6681

Fax: 613-226-2802 or 1-800-561-1970

E-mail: info@avtechpulse.com

World Wide Web: <http://www.avtechpulse.com>

TABLE OF CONTENTS

WARRANTY	2
TECHNICAL SUPPORT	2
TABLE OF CONTENTS	3
INTRODUCTION	5
AVAILABLE OPTIONS	5
SPECIFICATIONS	6
EC DECLARATION OF CONFORMITY	7
INSTALLATION	8
VISUAL CHECK	8
LINE VOLTAGE SELECTION	8
CONNECTION TO THE POWER SUPPLY	9
POWER RATINGS	10
ENVIRONMENTAL CONDITIONS	10
FUSES	11
AC FUSE REPLACEMENT	11
DC FUSE REPLACEMENT	12
FUSE RATINGS	12
FRONT PANEL CONTROLS	13
REAR PANEL CONTROLS	15
GENERAL INFORMATION	16
BASIC TEST ARRANGEMENT	16
GENERAL OPERATING NOTES	16
MINIMIZING WAVEFORM DISTORTIONS	18
USE 50Ω TRANSMISSION LINES AND LOADS	18
USE LOW-INDUCTANCE LOADS	18
PREVENTING DAMAGE	18
OPTIONS	19
-OT OPTION	19
-M OPTION	19
MECHANICAL INFORMATION	20

TOP COVER REMOVAL	20
ELECTROMAGNETIC INTERFERENCE	20
<i>MAINTENANCE</i>	<i>20</i>
REGULAR MAINTENANCE	20
CLEANING	20
<i>PERFORMANCE CHECK SHEET</i>	<i>21</i>

Manual Reference: T:\instructword\avn\AVNN, all -C models, europe, edition1.doc, created March 3, 2003

INTRODUCTION

The AVNN series of pulse generators are high performance instruments capable of operating at pulse repetition frequencies from 25 MHz to 250 MHz, with 100 ps rise and fall times. The output duty cycle may vary from 30% to 70%.

Model AVNN-1-C generates amplitudes as high as 5 Volts (peak-to-peak).

Model AVNN-2-C generates amplitudes as high as 2 Volts (peak-to-peak).

The output is designed to drive 50 Ω loads. (A 50 Ω load is required for proper operation.) The output is AC-coupled.

This instrument is intended for use in research and development laboratories.

AVAILABLE OPTIONS

The AVNN is available with several options:

"-OT" Option: an internally generated DC offset can be added to the output.

"-M" Option: a monitor output is provided.

SPECIFICATIONS

Model ¹ :	AVNN-1-C	AVNN-2-C
Amplitude: (50 Ohm load)	Variable to 5 Volts (peak to peak)	Variable to 2 Volts (peak to peak)
Pulse width:	Variable, 1.0 ns to 30 ns	
PRF:	25 MHz to 250 MHz	
Rise time:	≤ 100 ps	
Fall time:	≤ 100 ps	
Duty cycle:	Variable, 30% to 70%	
Polarity ² :	0 to ± 2.5 Volts	0 to ± 1.0 Volts
Propagation delay:	≤ 5 ns (Ext trig in to pulse out)	
Jitter:	± 15 ps (Ext trig in to pulse out)	
DC offset or bias insertion ³ :	Apply required DC offset to back panel solder terminals (± 50 Volts, 250 mA max)	
Trigger required:	ext trig mode: 0.3 RMS sine wave or 50% duty cycle square wave	
Sync output:	50 mV square wave	
Monitor output option ⁴ :	Provides a 20 dB attenuated coincident replica of main output	
Connectors:	Out: SMA, Trig: BNC, Sync: BNC, Monitor: SMA	
Other:	For power requirements, dimensions, chassis material, mounting, and temperature range, see the AVP Data sheet, page 24.	

- 1) -C suffix indicates stand-alone lab instrument with internal clock and line powering.
- 2) The high duty cycle waveform is AC-coupled and so the output is bipolar. A unipolar output may be obtained by inserting a DC offset.
- 3) To specify the internally-generated DC offset option (0 to ±5 V, one-turn control) add the suffix -OT to the model number.
- 4) For monitor option, add the suffix -M to the model number.

EC DECLARATION OF CONFORMITY

We

Avtech Electrosystems Ltd.
P.O. Box 5120, LCD Merivale
Ottawa, Ontario
Canada K2C 3H4

declare that this pulse generator meets the intent of Directive 89/336/EEC for Electromagnetic Compatibility. Compliance pertains to the following specifications as listed in the official Journal of the European Communities:

EN 50081-1 Emission

EN 50082-1 Immunity

and that this pulse generator meets the intent of the Low Voltage Directive 72/23/EEC as amended by 93/68/EEC. Compliance pertains to the following specifications as listed in the official Journal of the European Communities:

EN 61010-1:2001 Safety requirements for electrical equipment for measurement, control, and laboratory use

The image shows the CE mark, which consists of the letters 'C' and 'E' in a stylized, bold, sans-serif font. The 'C' is on the left and the 'E' is on the right, both rendered in a dark grey or black color.

INSTALLATION

VISUAL CHECK

After unpacking the instrument, examine to ensure that it has not been damaged in shipment. Visually inspect all connectors, knobs, and handles. Confirm that a power cord is with the instrument. If the instrument has been damaged, file a claim immediately with the company that transported the instrument.

LINE VOLTAGE SELECTION

Examine the rear of the instrument. There will be a power-entry module consisting of a male power receptacle, the main power switch, and a fuse holder / voltage selector. Confirm that the voltage selector is in the correct orientation. For AC line voltages of $115\text{V} \pm 10\%$, 50 - 60 Hz, the power selector card should be installed so that the "115" marking is visible from the rear of the instrument. For AC line voltages of $230\text{V} \pm 10\%$, 50 - 60 Hz, the power selector card should be installed so that the "230" marking is visible from the rear of the instrument. The two possible settings are shown below:

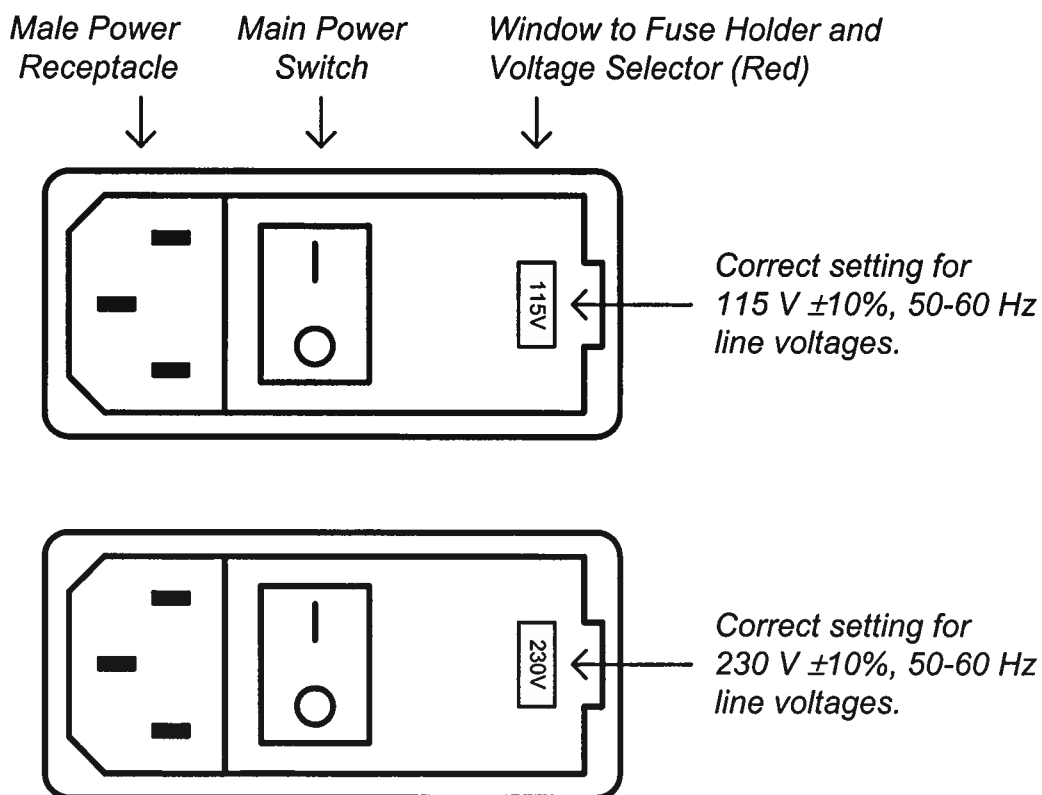

If the voltage selector is not set for to proper voltage, use a small flat-head screwdriver to pry open the voltage selector panel, as shown below:

Fuse Holder and Voltage Selector Panel.

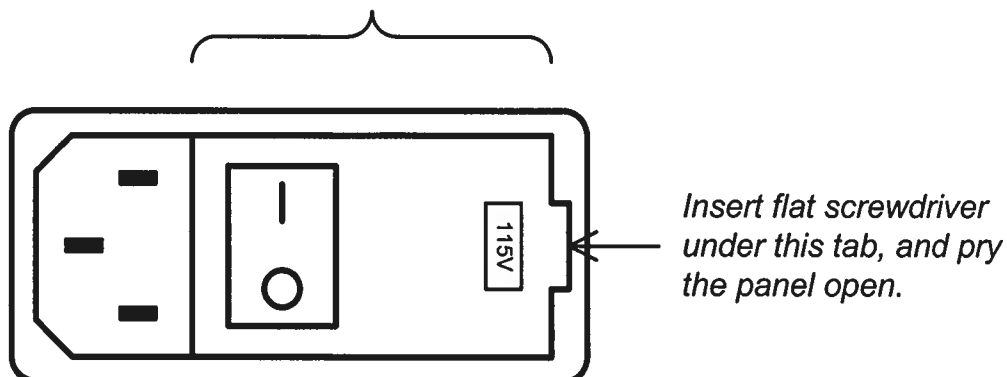

*Fuse Holder and Voltage Selector.
After opening the panel, the red plastic
fuse holder and voltage selector will be
visible.*

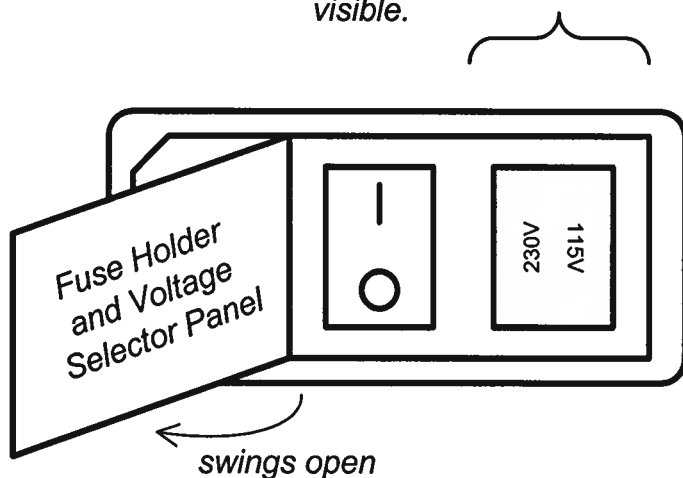

Once the panel is open, the red fuse holder / voltage selector should be visible. To change the voltage setting, pull out the red fuse holder / voltage selector and rotate it so that the proper voltage marking will shown through the panel window. Re-install the red fuse holder / voltage selector, and close the panel.

CONNECTION TO THE POWER SUPPLY

An IEC-320 three-pronged recessed male socket is provided on the back panel for AC power connection to the instrument. One end of the detachable power cord that is supplied with the instrument plugs into this socket. The other end of the detachable power cord plugs into the local mains supply. Use only the cable supplied with the instrument. The mains supply must be earthed, and the cable used to connect the

instrument to the mains supply must provide an earth connection. (The supplied cable does this.)

POWER RATINGS

This instrument is intended to operate from 115 / 230 V \pm 10%, 50-60 Hz. The maximum power consumption is 57 W. This instrument is an "Installation Category II" instrument, intended for operation from a normal single-phase supply.

ENVIRONMENTAL CONDITIONS

This instrument is intended for use under the following conditions:

- a) indoor use;
- b) altitude up to 2 000 m;
- c) temperature 5 °C to 40 °C;
- d) maximum relative humidity 80 % for temperatures up to 31 °C decreasing linearly to 50 % relative humidity at 40 °C;
- e) Mains supply voltage fluctuations up to \pm 10 % of the nominal voltage;
- f) no pollution or only dry, non-conductive pollution.

FUSES

This instrument contains four fuses. All are accessible from the rear-panel. Two protect the AC prime power input, and two protect the internal DC power supplies. The locations of the fuses on the rear panel are shown in the figure below:

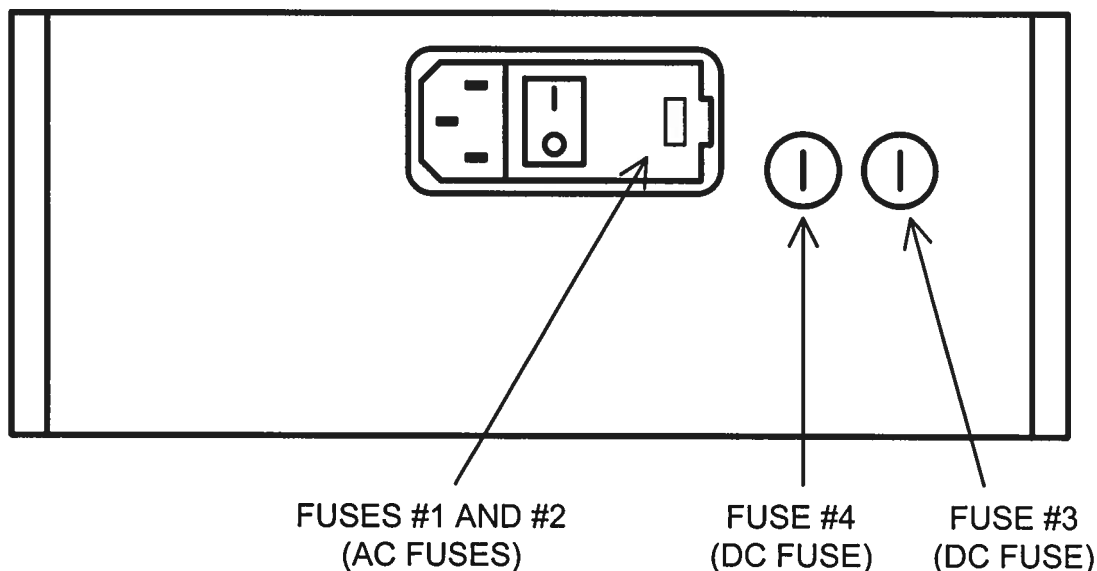

AC FUSE REPLACEMENT

The red fuse holder / voltage selector described in the previous section contains two fuses. One protects the AC "Line" input, and one protects the AC "Neutral" input. To replace the AC fuses, pull out the red fuse holder / voltage selector (as described in the previous section). The location of the two identical 5 mm x 20 mm fuses is shown below:

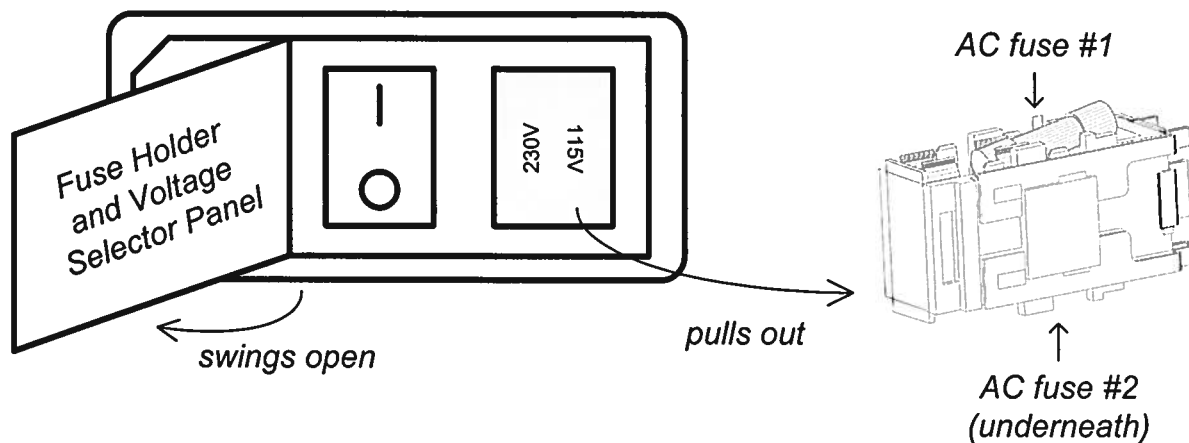

DC FUSE REPLACEMENT

The DC fuses may be replaced by inserting the tip of a flat-head screwdriver into the fuseholder slot, and rotating the slot counter-clockwise. The fuse and its carrier will then pop out.

FUSE RATINGS

The following table lists the required fuses:

Fuse	Mains Voltage	Rating	Case Size	Manufacturer's Part Number (Wickmann)	Distributor's Part Number (Digi-Key)
#1 (AC)	115 V	0.5A, 250V, Time-Delay	5 x 20 mm	1950500000	WK5041-ND
	230 V	0.25A, 250V, Time-Delay	5 x 20 mm	1950250000	WK5035-ND
#2 (AC)	115 V	0.5A, 250V, Time-Delay	5 x 20 mm	1950500000	WK5041-ND
	230 V	0.25A, 250V, Time-Delay	5 x 20 mm	1950250000	WK5035-ND
#3 (DC)	115/230V	0.8A, 250V, Time-Delay	5 x 20 mm	1950800000	WK5046-ND
#4 (DC)	115/230V	Not Used*	5 x 20 mm	Not Used*	Not Used*

* A spare fuse, identical to fuse #3, is installed in this position. It is not electrically active.

The fuse manufacturer is Wickmann (<http://www.wickmann.com/>).

Replacement fuses may be easily obtained from Digi-Key (<http://www.digikey.com/>) and other distributors.

FRONT PANEL CONTROLS

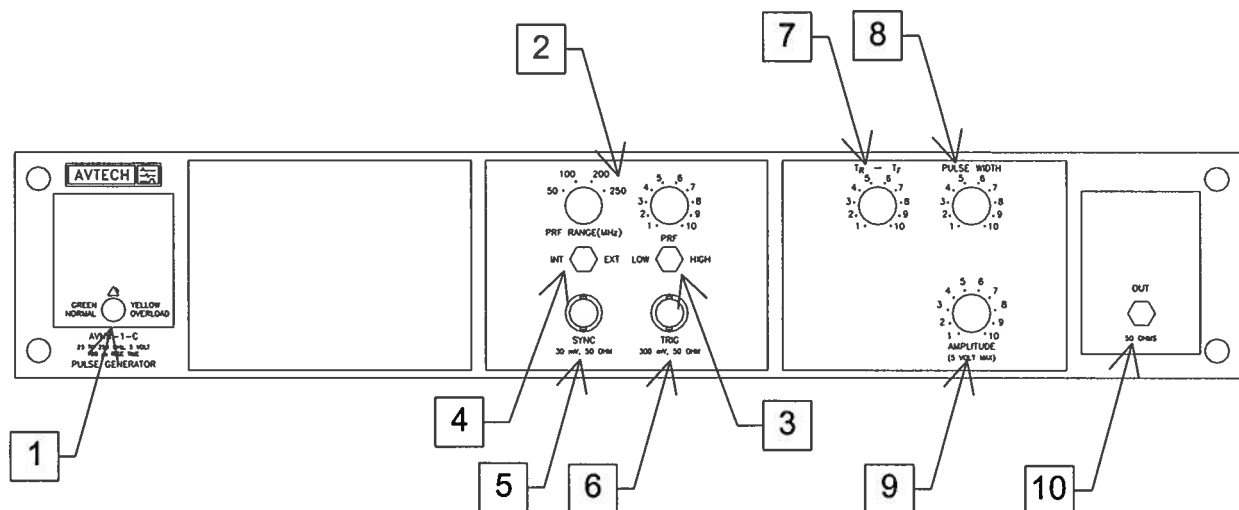

1. **OVERLOAD Indicator.** When the instrument is powered, this indicator is normally green, indicating normal operation. If this indicator is yellow, an internal automatic overload protection circuit has been tripped. If the unit is overloaded (by operating at an exceedingly high duty cycle or by operating into a very low impedance), the protective circuit will disable the output of the instrument and turn the indicator light yellow. The light will stay yellow (i.e. output disabled) for about 5 seconds after which the instrument will attempt to re-enable the output (i.e. light green) for about 1 second. If the overload condition persists, the output will be disabled again (i.e. light yellow) for another 5 seconds. If the overload condition has been removed, the instrument will resume normal operation.

This overload indicator may flash yellow briefly at start-up. This is not a cause for concern.

2. **PRF Range Switch.** This switch sets the pulse repetition frequency (PRF) range of the internal oscillator. The marked value of each position is the upper limit of the range, approximately. The vernier dial directly to the right of the switch varies the PRF within the set range.

If this switch is set to the "EXT" position, the instrument is triggered by a signal applied to the TRIG connector, rather than by the internal oscillator.

3. **HIGH / LOW Switch.** For operation below 100 MHz switch should be in the LOW position. For operation above 100 MHz switch should be in the HIGH position (in order to obtain fastest rise time and smoothest pulse shape). However, position of

this switch is not critical.

4. INT / EXT Switch. When this switch is in the INT position, the instrument is triggered by the internal oscillator, whose repetition frequency is controlled by item (2). When this switch is in the EXT position, the instrument requires a 0.3 V RMS sine wave applied at the TRIG input in order to trigger the output stages. In this mode the oscilloscope time base must be triggered by the external trigger source.
5. SYNC Output. This output is approximately coincident with the main output and may be used to trigger a sampling scope time base. The output is a 50 mV sine wave capable of driving a 50 Ohm load.
6. TRIG Input. The external trigger signal is applied at this input when the EXT-INT toggle switch is in the EXT position. See item (4).
7. TR-TF Controls. This dial controls flatness of pulse top and rise and fall time. Turn counter-clockwise to smooth top and to decrease rise, fall time.
8. PW Control. This dial varies the output pulse width / duty cycle. The duty cycle may be adjusted from approximately 30% to 70%.
9. AMP Control. This dial varies the output pulse amplitude from zero to maximum output.
10. OUT Connector. This SMA connector provides the main output to a 50 Ohm load.

REAR PANEL CONTROLS

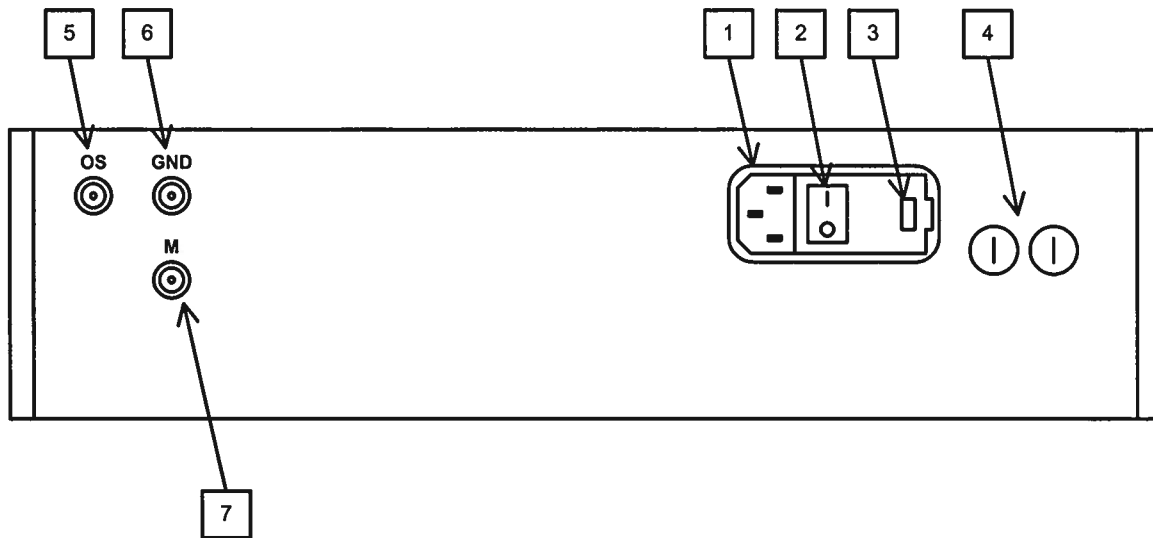

1. **AC POWER INPUT.** An IEC-320 three-pronged recessed male socket is provided on the back panel for AC power connection to the instrument. One end of the detachable power cord that is supplied with the instrument plugs into this socket.
2. **POWER SWITCH.** This is the main power switch. The instrument should be positioned so that the switch is accessible.
3. **FUSE HOLDER / VOLTAGE SELECTOR.** This red plastic module must be installed so that the marked voltage equals the AC line voltage. This module also contains two fuses that protect the AC inputs. Please see the "LINE VOLTAGE SELECTION" and "FUSES" sections of this manual for more information.
4. **DC FUSES.** These two fuses protect the internal DC power supplies. Please see the "FUSES" sections of this manual for more information.
5. **OS INPUT CONNECTOR.** A DC offset in the range of $\pm 50V$ (250 mA max) may be applied to this solder terminal. The DC offset will appear on the output. When this feature is not used, the OS input should be connected to ground (using the adjacent GND connector). This is especially important when driving loads containing a diode.
6. **GND CONNECTOR.** This solder terminal is connected to ground. It may be used to ground the OS input connector.
7. **M OUTPUT CONNECTOR.** (Present on units with -M option only.) This SMA connector output provides a 20 dB attenuated coincident replica of main output, for monitoring purposes.

GENERAL INFORMATION

BASIC TEST ARRANGEMENT

The AVNN should be tested with a sampling oscilloscope with a bandwidth of at least 10 GHz to properly observe the high-speed waveform. A typical test arrangement is shown below:

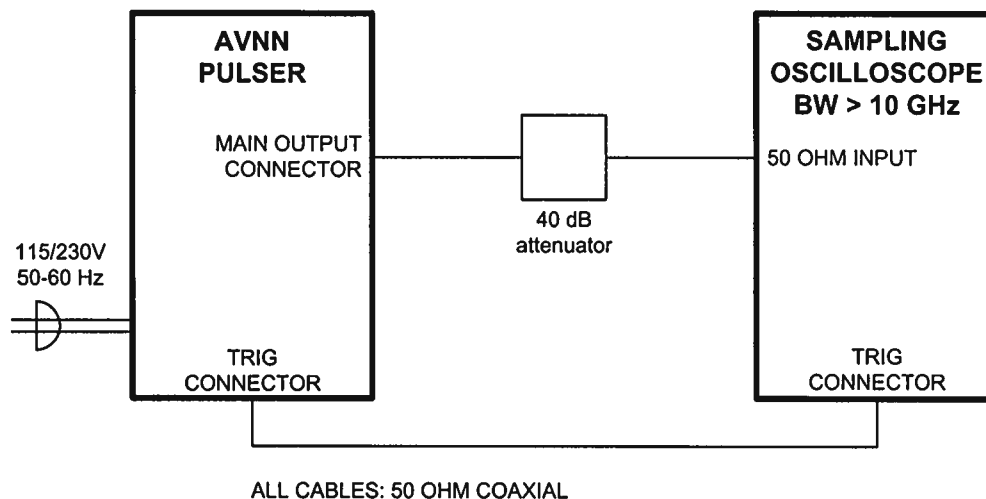

The attenuators are required to prevent damage to the sampling oscilloscope. A 40 dB attenuator with sufficient voltage rating should be used on the main output.

GENERAL OPERATING NOTES

- 1) The bandwidth capability of components and instruments used to display the pulse generator output signal (attenuators, cables, connectors, etc.) should exceed 10 GHz.
- 2) The use of 40 dB attenuator at the sampling scope vertical input channel will insure a peak input signal to the sampling scope of less than 1 Volt.
- 3) The SYNC output provides a 50 mV sine wave (to 50 Ohms).
- 4) To obtain a stable output display on a sampling oscilloscope, the PRF RANGE and PRF controls on the front panel should be set mid-range. The HIGH / LOW switch may be in either range. The front panel INT/EXT switch should be in the INT position. The pulse width control should be set mid-range while the amplitude and TR-TF controls should be set maximum clockwise. The prime power should be turned on and the scope triggering controls adjusted to obtain a

stable display. The PRF range switch and PRF control may then be adjusted to obtain the desired output PRF.

- 5) For operation below 100 MHz the frequency range should be in the LOW position while for operation above 100 MHz the switch should be in the HIGH position. However, position of this switch is not critical.
- 6) Clockwise rotation of the PW control increases the output duty cycle. Adjust for desired output pulse width (30 to 70% duty cycle).
- 7) The desired output amplitude is controlled primarily by the AMP control and partially by the TR-TF control. The TR-TF control also serves to sharpen the rise and fall times and to flatten the pulse top. Several iterative adjustments of the AMP and TR-TF controls may be necessary to simultaneously obtain the desired output amplitude while maintaining excellent pulse rise-fall times and flatness.
- 8) To trigger externally, set the INT-EXT switch to EXT and connect a sine wave generator to the TRIG connector. The output PRF will equal the sine wave PRF. The sine wave amplitude should be set at 0.3 VRMS.
- 9) To add a DC offset to the output pulse, connect a DC power supply set to required DC offset value to the back panel terminals marked "OS". The maximum attainable DC offset voltage is ± 50 Volts (for units without the -OT option only).

MINIMIZING WAVEFORM DISTORTIONS

USE 50Ω TRANSMISSION LINES AND LOADS

Connect the load to the pulse generator with 50Ω transmission lines (e.g. RG-58 or RG-174 cable).

This instrument requires a 50Ω load for proper operation. It will not properly drive a high-impedance load. The output stage will be damaged if it is operated into an open circuit (or any other high impedance). Failures due to improper output loading are not covered by the warranty.

USE LOW-INDUCTANCE LOADS

Lenz's Law predicts that for an inductive voltage spike will be generated when the current through an inductance changes. Specifically, $V_{\text{SPIKE}} = L \times dI_{\text{LOAD}}/dt$, where L is the inductance, I_{LOAD} is the load current change, and t is time. For this reason, it is important to keep any parasitic in the load low. This means keeping wiring short, and using low inductance components. In particular, wire-wound resistors should be avoided.

PREVENTING DAMAGE

The AVNN may fail if triggered at a PRF greater than 250 MHz.

This unit is designed to operate into a load impedance of 50 Ohms and the output stage will be damaged if it is operated into an open circuit (or any other high impedance). Failures due to improper output loading are not covered by the warranty.

The lifetime of the switching elements in the pulse generator module is proportional to the running time of the instrument. For this reason the prime power to the instrument should be turned off when the instrument is not in use.

OPTIONS

The AVNN is available with these options:

-OT OPTION

This option allows an internally generated DC offset to be added to the output. The output DC offset is variable from +5 to -5 Volts by means of the front-panel one-turn OFFSET control. The offset control may be turned off by means a the rear panel ON-OFF OFFSET switch.

-M OPTION

This option provides a monitor output, which is an attenuated replica of the main output. The monitor is connected to the main output through a 470 Ohm resistor, which results in an attenuation of approximately 20 dB (i.e., $\div 10$) when the monitor output is terminated with a 50 Ohm load.

The monitor output should be terminated with a 50 Ohm load.

MECHANICAL INFORMATION

TOP COVER REMOVAL

If necessary, the interior of the instrument may be accessed by removing the four Phillips screws on the top panel. With the four screws removed, the top cover may be slid back (and off).

Always disconnect the power cord before opening the instrument.

There are no user-adjustable internal circuits. For repairs other than fuse replacement, please contact Avtech (info@avtechpulse.com) to arrange for the instrument to be returned to the factory for repair.

 Caution: High voltages are present inside the instrument during normal operation. Do not operate the instrument with the cover removed.

ELECTROMAGNETIC INTERFERENCE

To prevent electromagnetic interference with other equipment, all used outputs should be connected to shielded 50Ω loads using shielded 50Ω coaxial cables. Unused outputs should be terminated with shielded 50Ω BNC terminators or with shielded BNC dust caps, to prevent unintentional electromagnetic radiation. All cords and cables should be less than 3m in length.

MAINTENANCE

REGULAR MAINTENANCE

This instrument does not require any regular maintenance.

On occasion, one or more of the four rear-panel fuses may require replacement. All fuses can be accessed from the rear panel. See the “FUSES” section for details.

CLEANING

If desired, the interior of the instrument may be cleaned using compressed air to dislodge any accumulated dust. (See the “TOP COVER REMOVAL” section for instructions on accessing the interior.) No other cleaning is recommended.

March 3/2003