

# AVTECH ELECTROSYSTEMS LTD.

NANOSECOND WAVEFORM ELECTRONICS  
ENGINEERING - MANUFACTURING

□ P.O. BOX 265  
OGDENSBURG  
NEW YORK  
13669  
(315) 472-5270

☒ BOX 5120, STN. "F"  
OTTAWA, ONTARIO  
CANADA K2C 3H4  
TEL: (613) 226-5772  
FAX: (613) 226-2802  
TELEX: 053-4591

## INSTRUCTIONS

MODEL AVN-C-FDICA PULSE GENERATOR

S.N.:

### WARRANTY

Avtech Electrosystems Ltd. warrants products of its manufacture to be free from defects in material and workmanship under conditions of normal use. If, within one year after delivery to the original owner, and after prepaid return by the original owner, this Avtech product is found to be defective, Avtech shall at its option repair or replace said defective item. This warranty does not apply to units which have been disassembled, modified or subjected to conditions exceeding the applicable specifications or ratings. This warranty is the extent of the obligation or liability assumed by Avtech with respect to this product and no other warranty or guarantee is either expressed or implied.

Fig. 1

PULSE GENERATOR TEST ARRANGEMENT

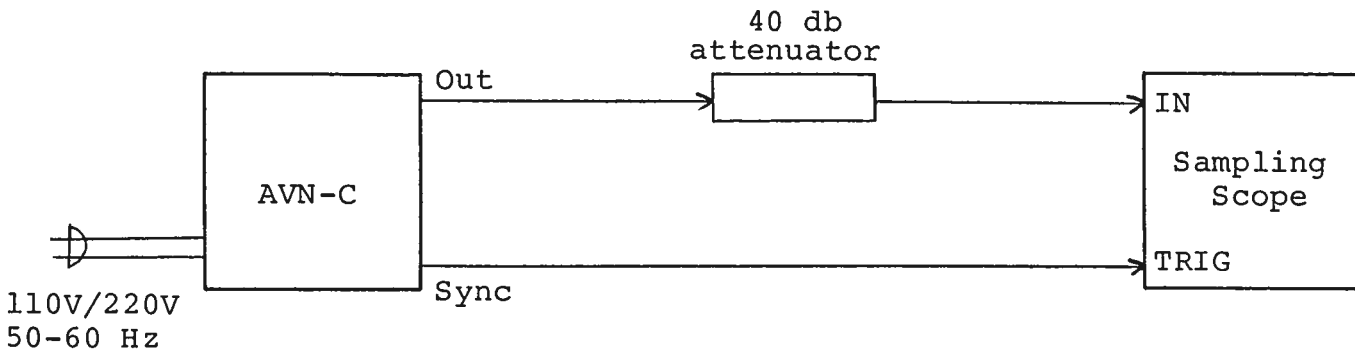

Notes:

- 1) The bandwidth capability of components and instruments used to display the pulse generator output signal (attenuators, cables, connectors, etc.) should exceed ten gigahertz.
- 2) The use of 40 db attenuator at the sampling scope vertical input channel will insure a peak input signal to the sampling scope of less than one volt.
- 3) To obtain a stable output display the PRF and PRF FINE controls on the front panel should be set mid-range while the PRF range switch may be in either range. The front panel TRIG toggle switch should be in the INT position. The scope triggering controls are then adjusted to obtain a stable output.
- 4) The output pulse shape is determined by the two front panel pot controls TR and TF. TR controls the leading edge of the pulse while TF controls the falling edge. Clockwise rotation of TR and TF increases the output pulse width. Initially rotate the TF pot fully clockwise and set the TR pot at mid-range. The output amplitude is controlled by the front panel AMP control and by the input signal level. Initially the AMP control should be set maximum clockwise. The CRT display will resemble the following:

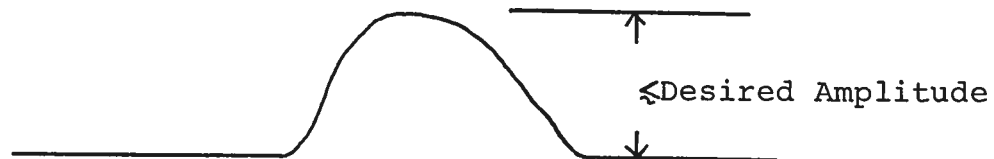

- 5) Having obtained a display of the form shown above, the desired pulse width is then obtained by adjusting the two front panel pots TR and TF. Rotate TR counterclockwise from the positive set in step 2) until a sharp 100 psec leading edge is observed. Then rotate TF counterclockwise until the desired pulse width and fall time are obtained.

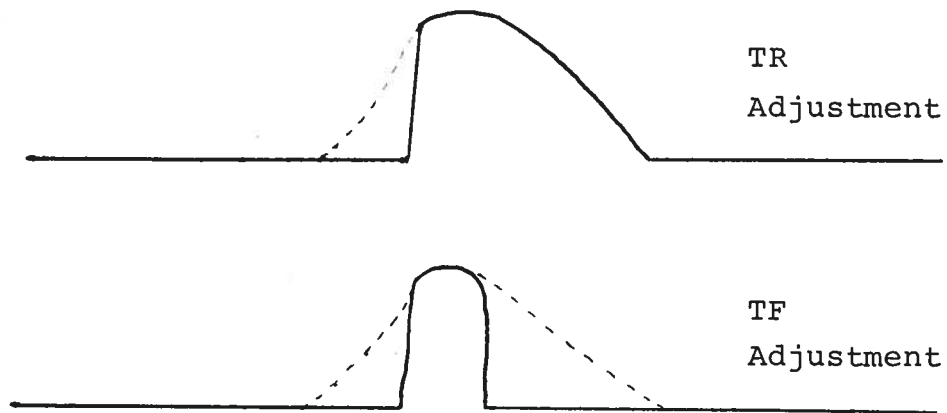

Further iterative adjustments of TR and TF will be necessary to simultaneously obtain the lowest rise time, lowest fall time, the desired pulse width, and pulse top shape, and low spurious signal level. In addition some additional adjustment of signal level may be necessary to obtain the desired amplitude. If the input frequency is then changed it will be necessary to readjust AMP, TR and TF to establish the required pulse shape. Following the above sequence it is possible to generate output pulses having amplitudes of at least 5 volts with variable pulse width (at least from 200 to 1000 psec) with pulse repetition frequencies in the range of 50 to 260 MHz.

- 6) To trigger externally, set the INT-EXT switch to EXT and connect a sine wave generator to the TRIG connector. The output PRF will equal the sine wave PRF. The sine wave amplitude should be set at 0.3 VRMS.
- 7) To DC offset the output pulse connect a DC power supply set to required DC offset value to the back panel terminals marked O.S. The maximum attainable DC offset voltage is  $\pm 50$  volts (for units without the OT or EO option only).
- 8) For units with the OT or EO options, the output DC offset is variable from +5 to -5 volts by means of the front panel one turn OFFSET control. The offset control may be turned off by means of the rear panel ON-OFF OFFSET switch.
- 9) For units with the EO option, the output offset may be voltage controlled by removing the jumper wire between banana plugs A and B on the back panel and applying 0 to +10 volts to connector B ( $R_{IN} > 10K$ ).
- 10) Dual Polarity Option (for units without the OT or EO options).

To invert the output of the AVN unit, connect the AVX-2-T unit to the OUT port. An inverted pulse with a rise time  $< 100$  psec is then obtained at the OUT port of the AVX-2-T unit. To offset the inverted pulse, apply the required DC level to the DC terminal of the AVX-2-T unit.

- 11) Dual Polarity Option (for units with the OT or EO options).

To invert the output of the AVN unit, connect the AVX-2-T-OT unit to the OUT port. An inverted pulse with a rise time  $< 100$  psec is then obtained at the OUT port of the AVX-2-T-OT unit. To offset the inverted pulse, connect a lead from the rear panel OS OUT banana plug to

the DC terminal of the AVX-2-T-OT unit. The DC offset at the output of the AVX-2-T-OT unit is then controlled by the front panel OFFSET control.

- 12) The AVN-C unit can be converted from 110 to 220V 50-60 Hz operation by adjusting the voltage selector card in the rear panel fused voltage selector-cable connector assembly.
- 13) CAUTION: The unit may overheat if attempts are made to obtain more than 5 volts out, particularly at frequencies higher than 150 MHz. When overheated, the output pulse will diminish in amplitude and eventually vanish. To re-establish the pulse, turn the amplitude control counter clockwise and the pulse should re-appear after the unit has cooled.

Fig. 2

FRONT PANEL CONTROLS

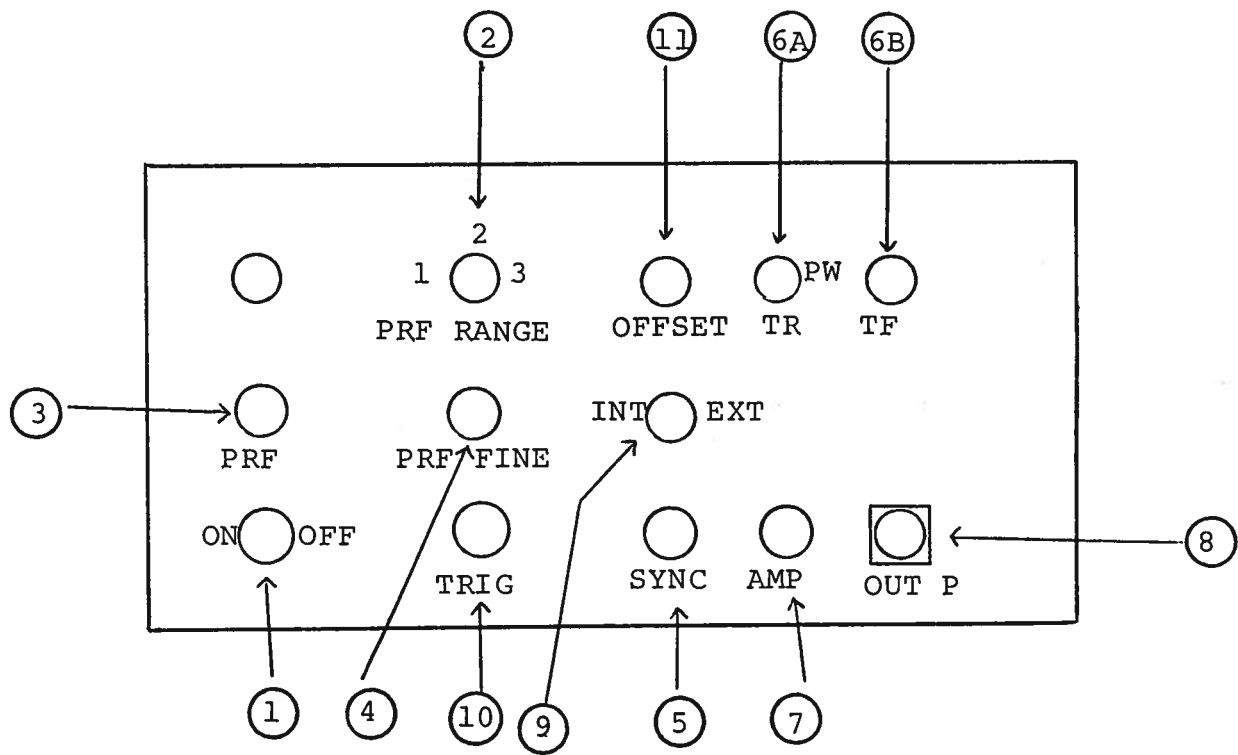



- (1) ON-OFF Switch. Applies basic prime power to all stages.
- (2) PRF Control. PRF RANGE, PRF and PRF FINE controls
- (3) determine output PRF as follows:

	PRF MIN	PRF MAX
Range 1	50 MHz	125
Range 2	100	200
Range 3	100	250

- (4) PRF FINE Control. This control varies PRF but is about 10 times less sensitive than the main PRF control.
- (5) SYNC Output. This output is approximately coincident with the main output (9) and is used to trigger the sampling scope time base. The output is a 1 volt RMS sine wave capable of driving a fifty ohm load.
- (6) PW Control. One turn controls which vary the output pulse width. The output pulse shape is determined by the two front panel pot controls TR and TF. TR controls the leading edge of the pulse while TF controls the falling edge. Clockwise rotation of TR and TF increases the output pulse width.
- (7) AMP Control. A one turn control which varies the output pulse amplitude from 0 to max output to a fifty ohm load.
- (8) OUT Connector. SMA connector provides output to a fifty ohm load.
- (9) EXT-INT Control. With this toggle switch in the INT position, the PRF of the AVN unit is controlled via an internal clock which in turn is controlled by the PRF and PRF FINE controls. With the toggle switch in the EXT position, the AVN unit requires a 0.3 V RMS sine wave applied at the TRIG input in order to trigger the output stages. In addition, in this mode, the scope time base must be triggered by the external trigger source.
- (10) TRIG Input. The external trigger signal is applied at this input when the EXT-INT toggle switch is in the EXT position.
- (11) OFFSET (option). A one turn control for varying the output DC offset from -5 to +5 volts.

Fig. 3

BACK PANEL CONTROLS (UNITS WITHOUT OT OR  
EO OPTIONS)

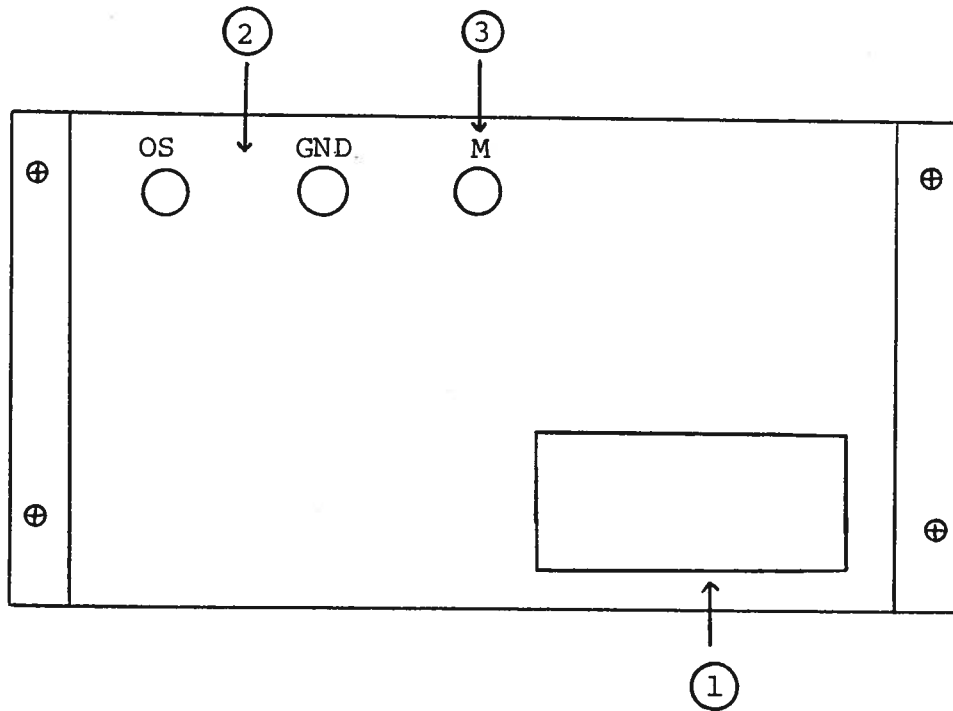

- (1) FUSED CONNECTOR, VOLTAGE SELECTOR. The detachable power cord is connected at this point. In addition, the removable cord is adjusted to select the desired input operating voltage. The unit also contains the main power fuse.
- (2) DC OFFSET Input. To DC offset the output pulse, connect a DC power supply set to the desired offset value to these terminals. The maximum allowable DC offset voltage is  $\pm 50$  volts.
- (3) MONITOR OUT M. Provides an attenuated ( $\times 10$ ) coincident replica of the main positive output pulse to fifty ohms (option).

Fig. 3

BACK PANEL CONTROLS (UNITS WITH OT OPTION)

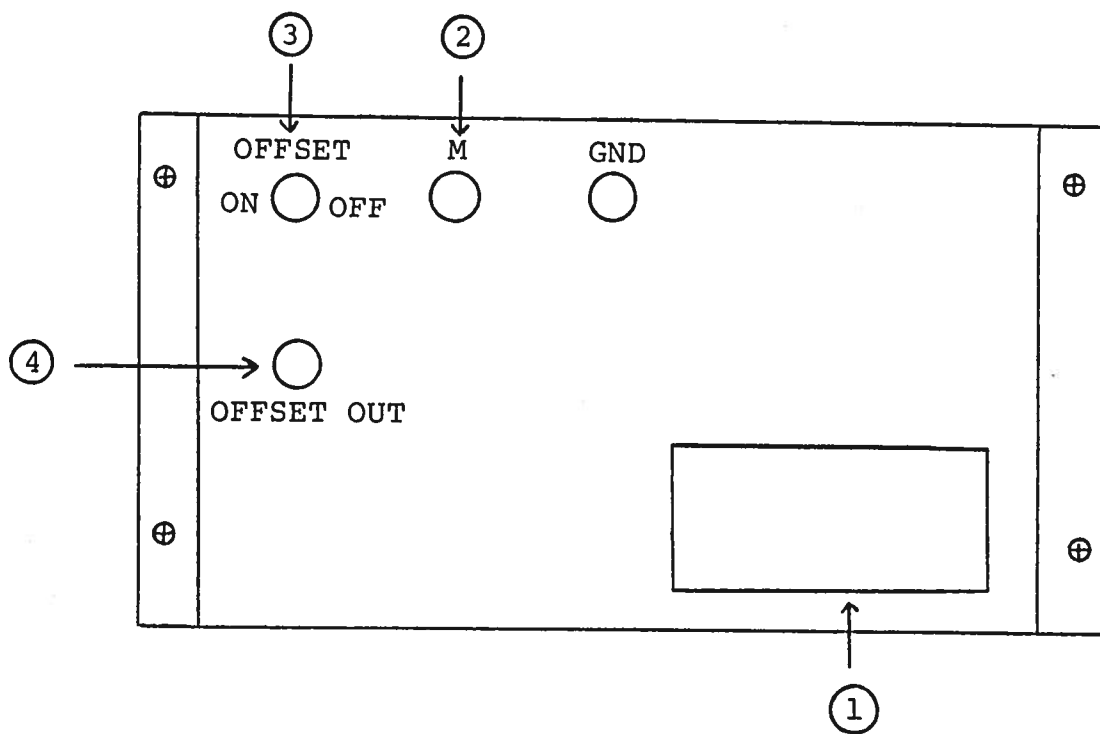

- (1) FUSED CONNECTOR, VOLTAGE SELECTOR. The detachable power cord is connected at this point. In addition, the removable cord is adjusted to select the desired input operating voltage. The unit also contains the main power fuse.
- (2) MONITOR OUT M. Provides an attenuated (x10) coincident replica of the main positive output pulse to fifty ohms (option).
- (3) DC OFFSET. To turn DC output offset OFF put toggle switch in OFF position.
- (4) OFFSET OUT. To offset an inverted output pulse, connect a lead from the OFFSET OUT terminal to the DC terminal of the AVX-2-T-OT unit. The DC offset at the output of the AVX-2-T-OT unit is then controlled by the front panel OFFSET control.

Fig. 4

SYSTEM BLOCK DIAGRAM

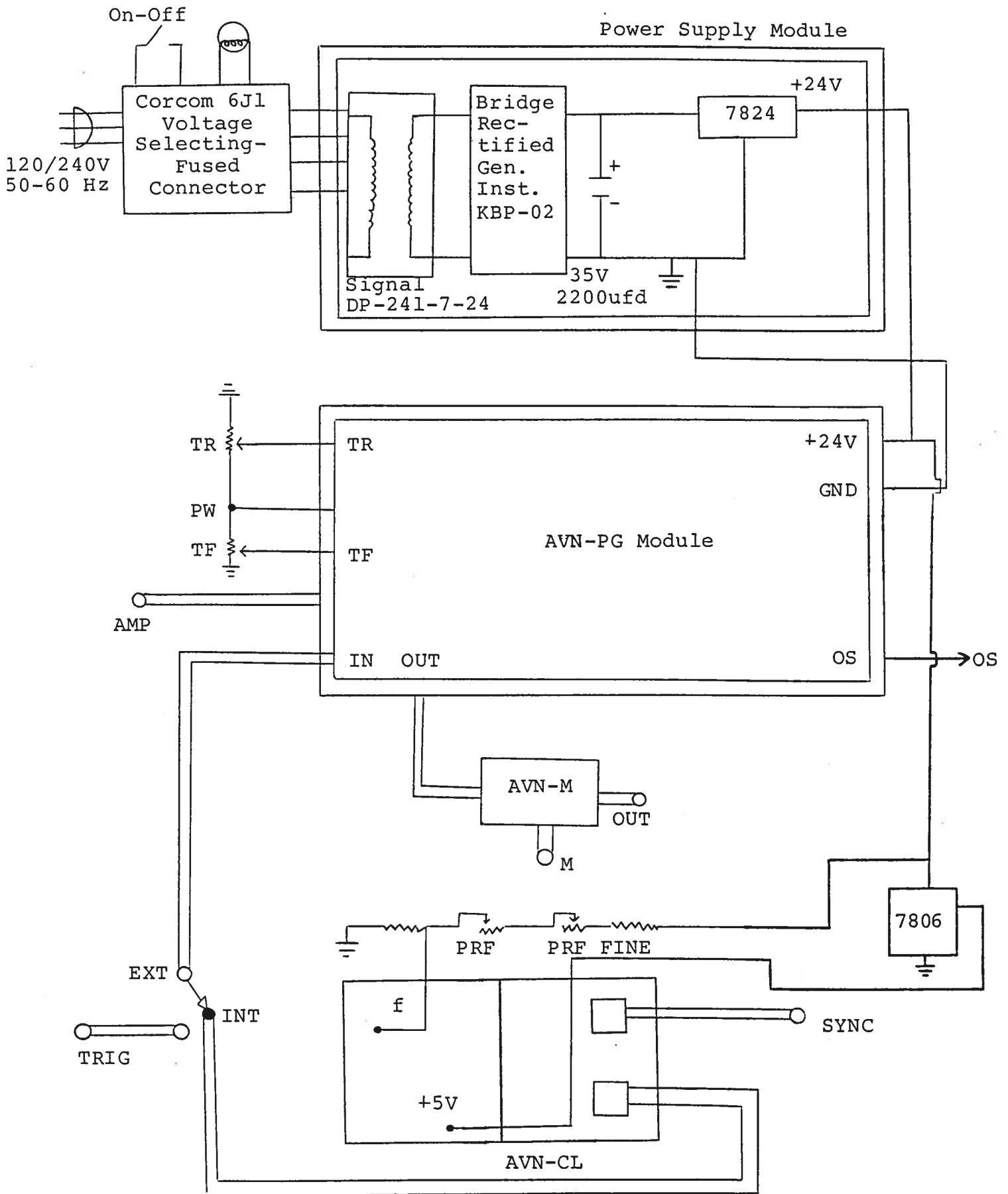

## SYSTEM DESCRIPTION AND REPAIR PROCEDURE

The AVN-C consists of a pulse generator module (AVN-PG), a clock module (AVN-CL) and a power supply board which supplies +24 volts (600 mA max) to the pulse generator module. In the event that the unit malfunctions, remove the instrument cover by removing the four Phillips screws on the back of the unit. The top may then be slid off. Measure the voltage at the +24V pin of the PG module. If this voltage is substantially less than +24 volts, unsolder the line connecting the power supply and PG modules and connect 50 ohm 10 W load to the PS output. The voltage across this load should be about +24 V DC. If this voltage is substantially less than 24 volts the PS module is defective and should be repaired or replaced. If the voltage across the resistor is near 24 volts, then the PG module should be replaced or repaired. The sealed PG module must be returned to Avtech for repair (or replacement). The clock module provides a 0.3 V RMS sine wave to trigger the PG module and a 30 mV sine wave to trigger the sampling scope display device. The clock module is powered by +5.0V supplied by the PG module. With the INT-EXT switch in the EXT position, the clock module is disconnected from the PG module.

The sealed clock module must be returned to Avtech for repair or replacement if the above conditions are not observed.

Schroff

10.19.90

-TRF

-OS

-OT

-EO

-PN

-M