



**AVTECH ELECTROSYSTEMS LTD.**

NANOSECOND WAVEFORM ELECTRONICS  
SINCE 1975

□ P.O. BOX 265  
OGDENSBURG, NY  
U.S.A. 13669-0265  
TEL: (315) 472-5270  
FAX: (613) 226-2802

TEL: 1-800-265-6681  
FAX: 1-800-561-1970  
U.S.A. & CANADA

e-mail: [info@avtechpulse.com](mailto:info@avtechpulse.com)

✠ BOX 5120 STN. F  
OTTAWA, ONTARIO  
CANADA K2C 3H4  
TEL: (613) 226-5772  
FAX: (613) 226-2802

INSTRUCTIONS

MODEL AVO-5B1-C PULSE GENERATOR  
MODEL AVX-S3D BIAS INSERTION UNIT

S.N.: 7260

### WARRANTY

Avtech Electrosystems Ltd. warrants products of its manufacture to be free from defects in material and workmanship under conditions of normal use. If, within one year after delivery to the original owner, and after prepaid return by the original owner, this Avtech product is found to be defective, Avtech shall at its option repair or replace said defective item. This warranty does not apply to units which have been disassembled, modified or subjected to conditions exceeding the applicable specifications or ratings. This warranty is the extent of the obligation or liability assumed by Avtech with respect to this product and no other warranty or guarantee is either expressed or implied.

Fig. 1

BIAS INSERTION UNIT TEST ARRANGEMENT

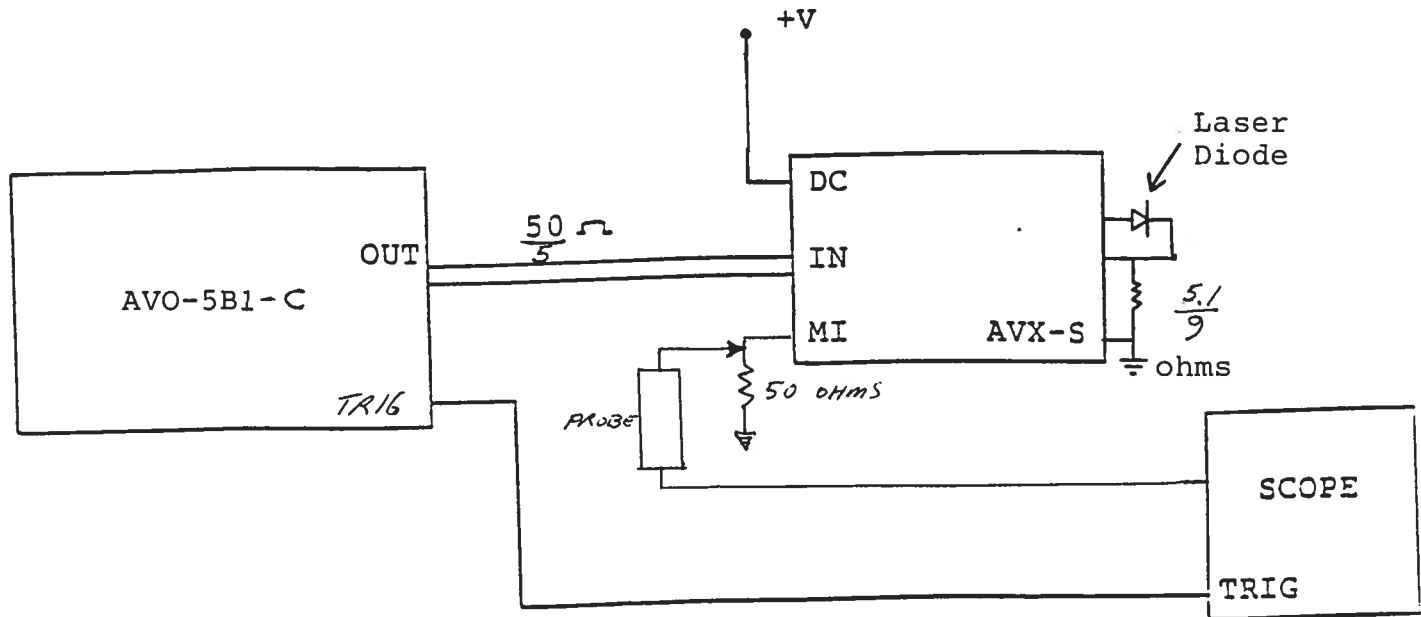
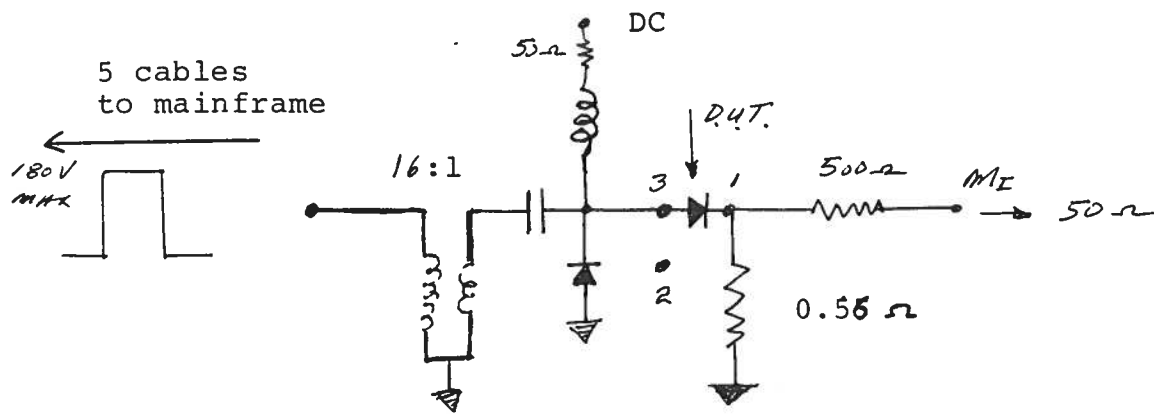

Fig. 2

FUNCTIONAL EQUIVALENT CIRCUIT



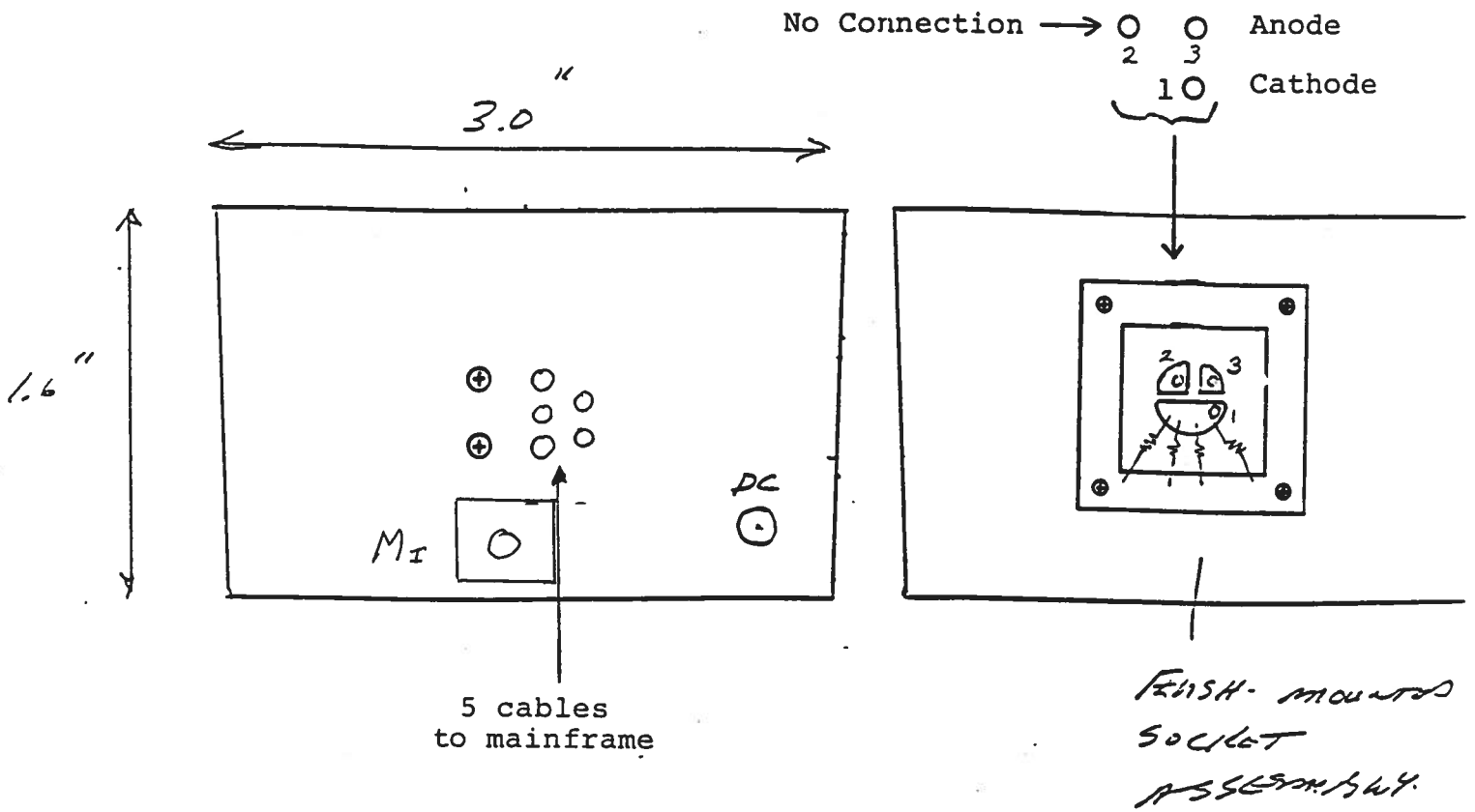
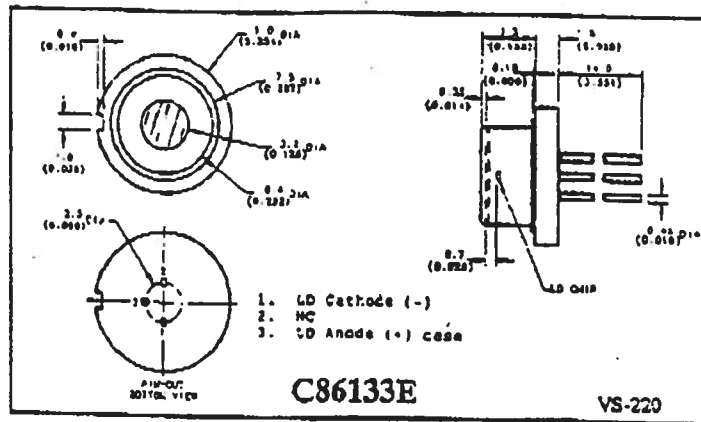

Fig 3: VACUUM MOUNTED SOCKET ASSEMBLY

**DEVELOPMENTAL TYPE - PRELIMINARY DATA SHEET**



1550nm - Pulse Operated Indium Gallium Arsenide Phosphide High Power Four Element Laser Diode Array

Characteristics at 25°C, duty factor = 0.02%				
PARAMETERS	MIN	TYP	MAX	UNITS
Peak output power ( $P_o$ )	40	50		W
Peak forward current ( $i_f$ )		75		A
Threshold current ( $i_{th}$ )		5		A
Forward Voltage Drop ( $V_f$ )		40		V
Peak wavelength ( $\lambda_m$ )	1520	1550	1580	nm
Spectral width ( $\Delta\lambda$ )		15	25	nm
Pulse width ( $t_w$ )			50	ns
Pulse repetition rate (prf)			5	KHz
Source dimensions total (h x w)		300 x 300		$\mu\text{m}$
Operating temp. range ( $T_{oper}$ )	-20		70	°C
Storage temperature range ( $T_{stor}$ )	-55		100	°C

Alternate package outlines are available as options upon request.

For further information please contact your local EG&G Optoelectronics Canada representative or EG&G Optoelectronics Canada, 22001 Dumberry Road, Vaudreuil, Quebec J7V 8P7 Canada

Tel: (514) 424-3300

Fax: (514) 424-3411

March 1, 1993

Notes:

- 1) The anode is inserted into PIN 3 while the cathode lead is inserted into PIN 1. There is no connection to PIN 2. CAUTION: When inserting the laser diode into the socket, insure that the case of the diode does not contact the resistor connected to PIN 1 as this will effectively short out the diode so the current will flow through the case rather than through the diode.
- 2) The DC terminal of the bias insertion must either be shorted to ground (if a DC offset is not required) or a DC power supply must be applied. The laser diode will not function if the DC terminal is open circuited. Note that the DC current must not exceed  $\pm 100$  mA.
- 3) The MI port must be terminated into 50 Ohms. MI provides outputs as high as 4.5 Volts.
- 4) The diode current  $I_D$  (Amps) and the MI output voltage are related as follows:
$$I_D \approx 18 M_1$$
- 5) Note that if the ON voltage (or resistance) of the laser diode is unusually high, it may be necessary to reduce the 0.56 Ohm sensing resistor value in order to obtain 75 Amperes. If this is necessary, contact AVTECH for guidance.

## MAINFRAME OPERATION

### Notes:

- 1) The equipment should be connected in the general fashion shown above. Since the AVO unit provides an output pulse rise time as low as 10 ns a fast oscilloscope (at least 50 MHz and preferably 200 MHz) should be used to display the waveform. If a sampling scope is used, a 30 dB (or greater) attenuator should be used to insure a peak input to the scope of less than 0.5 Volts.
- 2) The TRIG output channel provides TTL level signals. To avoid overdriving the TRIG input channel of some scopes, a 30 dB attenuator should be placed at the input to the scope trigger channel. The TRIG output precedes the main output when the front panel ADVANCE-DELAY switch is in the ADVANCE position. The TRIG output lags the main output when the switch is in the DELAY position.
- 3) To obtain a stable output display the PRF controls on the front panel should be set mid-range. The front panel TRIG toggle switch should be in the INT position. The front panel DELAY control and the scope triggering controls are then adjusted to obtain a stable output. The scope may then be used to set the desired PRF by rotating the PRF controls.
- 4) The AVX-S3D module transforms the 180 Volt (to 10 Ohms) output of the mainframe to 45 Volts (to 0.56 Ohms) to produce up to 75 Amperes. See the preceding 3 pages for a detailed discussion of the operation of this module.
- 5) The output pulse width is controlled by means of the front panel one turn PW control. To voltage control the pulse width, set the rear panel switch in the EXT position and apply 0 to +10 Volts between terminal A and ground ( $R_{IN} \geq 10K$ ). (option).
- 6) The output pulse amplitude is controlled by means of the front panel one turn AMP control. To voltage control the output, set the rear panel switch in the EXT position and apply 0 to +10 Volts between terminal A and ground ( $R_{IN} \geq 10K$ ). (option).

7) AVO-5B1-C units with a serial number higher than 5600 are protected by an automatic overload protective circuit which controls the front panel overload light. If the unit is overloaded (by operating at an exceedingly high duty cycle or by operating into a short circuit), the protective circuit will turn the output of the instrument OFF and turn the indicator light ON. The light will stay ON (i.e. output OFF) for about 5 seconds after which the instrument will attempt to turn ON (i.e. light OFF) for about 1 second. If the overload condition persists, the instrument will turn OFF again (i.e. light ON) for another 5 seconds. If the overload condition has been removed, the instrument will turn on and resume normal operation. Overload conditions may be removed by:

- 1) Reducing PRF (i.e. switch to a lower range)
- 2) Reducing pulse width (i.e. switch to a lower range)
- 3) Removing output load short circuit (if any)

8) The unit can be converted from 110 to 220V 50-60 Hz operation by adjusting the voltage selector card in the rear panel fused voltage selector-cable connector assembly.

9) For additional assistance:

Tel: (613) 226-5772  
Fax: (613) 226-2802



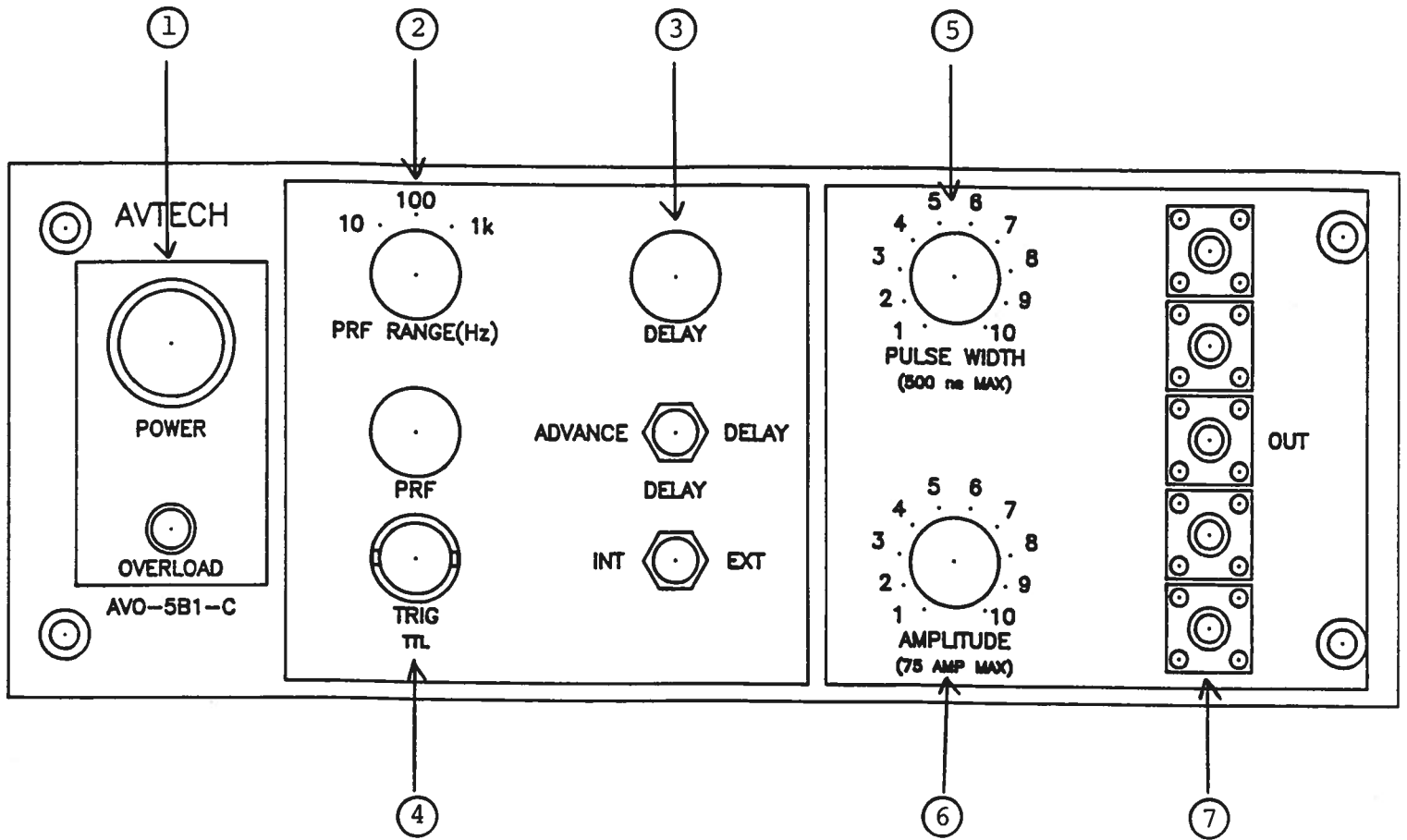

Fig. 4

FRONT PANEL CONTROLS

- (1) ON-OFF Switch. Applies basic prime power to all stages.
- (2) PRF Control. Varies PRF as follows:
 

Range 1	1 Hz	10 Hz
Range 2	10 Hz	100 Hz
Range 3	100 Hz	1 kHz
- (3) DELAY Control. Controls the relative delay between the reference output pulse provided at the TRIG output (4) and the main output (7). This delay is variable over the range of 0 to about 0.5 us. The TRIG output precedes the main output when the ADVANCE-DELAY switch is in the ADVANCE position and lags when the switch is in the DELAY position.
- (4) TRIG Output. This output precedes the main output (7) and is used to trigger the sampling scope time base. The output is a TTL level 100 ns (approx) pulse capable of driving a fifty Ohm load.
- (5) PW Control. A one turn control which varies the output pulse width from 50 to 500 ns.
- (6) AMP Control. The output pulse amplitude is controlled by means of the one turn potentiometer (AMP).
- (7) OUT Connectors. Five SMA connectors for five miniature coaxial cables connected to the AVX-S3D module.
- (8) EXT-INT Control. With this toggle switch in the INT position, the PRF of the AVO unit is controlled via an internal clock which in turn is controlled by the PRF controls. With the toggle switch in the EXT position, the AVO unit requires a 0.2 us TTL level pulse applied at the TRIG input in order to trigger the output stages.
- (9) AVO-5B1-C units with a serial number higher than 5600 are protected by an automatic overload protective circuit which controls the front panel overload light. If the unit is overloaded (by operating at an exceedingly high duty cycle or by operating into a short circuit), the protective circuit will turn the output of the instrument OFF and turn the indicator light ON. The light will stay ON (i.e. output OFF) for about 5 seconds after which the instrument will attempt to turn ON (i.e. light OFF) for about 1 second. If the overload condition persists, the instrument will turn OFF again (i.e. light ON) for another 5 seconds. If the overload condition has been removed, the instrument will turn on and resume normal operation. Overload conditions may be removed by:

- 1) Reducing PRF (i.e. switch to a lower range)
- 2) Reducing pulse width (i.e. switch to a lower range)
- 3) Removing output load short circuit (if any)

Fig. 3

BACK PANEL CONTROLS

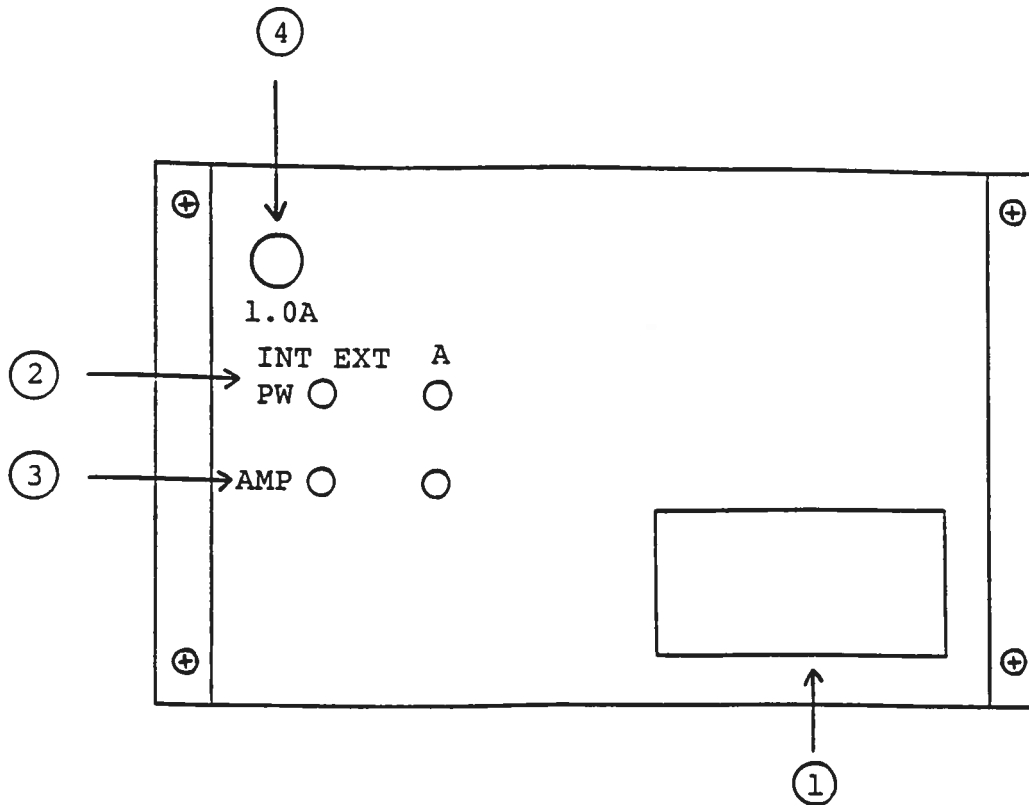

- (1) FUSED CONNECTOR, VOLTAGE SELECTOR. The detachable power cord is connected at this point. In addition, the removable cord is adjusted to select the desired input operating voltage. The unit also contains the main power fuse (0.5 A SB).
- (2) EA. To voltage control the output amplitude, set the switch in the EXT position and apply 0 to +10 Volts between terminal A and ground ( $R_{IN} \geq 10K$ ). (option).
- (3) EW. To voltage control the output pulse width, set the switch in the EXT position and apply 0 to +10 Volts between terminal A and ground ( $R_{IN} \geq 10K$ ). (option).
- (4) 1.0A SB. This fuse limits the DC prime power supplied to the output stage and will blow in the case of severe overloading.

Fig. 4

SYSTEM BLOCK DIAGRAM

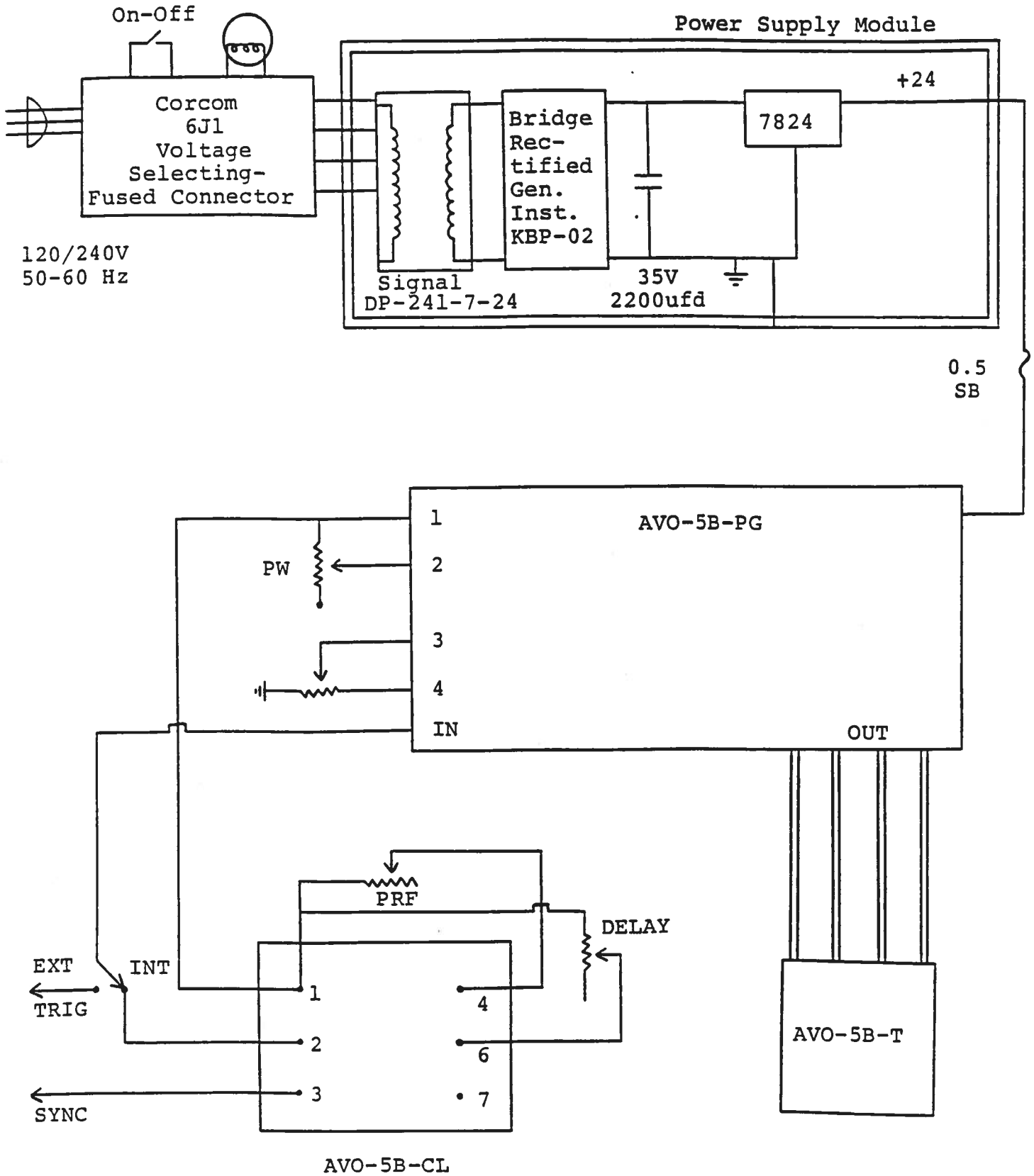

## SYSTEM DESCRIPTION AND REPAIR PROCEDURE

The AVO-5B1-C unit consists of the following basic modules:

- 1) AVO-5B1-PG pulse generator module
- 2) AVO-5B1-CL clock module
- 3) +24V power supply board

The modules are interconnected as shown in Fig. 4. The clock module controls the output PRF and the relative delay between the main output and the TRIG output. The PG pulse generator module generates the output pulse. In the event of an instrument malfunction, it is most likely that the rear panel 1.0A SB fuse may have failed due to an output short circuit condition or to a high duty cycle condition. If the fuse has not blown, then the four Phillips screws on the back panel should be removed. The top cover may then be slid off and the operation of the clock and power supply modules checked. The clock module is functioning properly if:

- a) 0.1 us TTL level outputs are observed at pins 2 and 3.
- b) The PRF of the outputs can be varied over the range of 1 Hz to 1.0 kHz using the PRF and PRF FINE controls.
- c) The relative delay between the pin 2 and 3 outputs can be varied by at least 200 ns by the DELAY control.

The sealed clock module must be returned to Avtech for repair or replacement if the above conditions are not observed. The power supply board generates +24V DC to power the other modules. If the voltage is less than +24V, turn off the prime power and unsolder the lead from the 7824 regulator chip on the power supply board. Solder a 100 Ohm 5 Watt resistor to the 7824 output to ground and turn on the prime power. A voltage of +24 Volts should be read. If the voltage is less then the power supply board is defective and should be repaired or replaced.

May 10/95

-EW

-EA

Disk: AVO-5B

Name: SBICAVX.INS