



AVTECH ELECTROSYSTEMS LTD.

NANOSECOND WAVEFORM ELECTRONICS
SINCE 1975

P.O. BOX 265
OGDENSBURG, NY
U.S.A. 13669-0265
TEL: (315) 472-5270
FAX: (613) 226-2802

TEL: 1-800-265-6681
FAX: 1-800-561-1970
U.S.A. & CANADA

e-mail: info@avtechpulse.com

BOX 5120 STN. F
OTTAWA, ONTARIO
CANADA K2C 3H4
TEL: (613) 226-5772
FAX: (613) 226-2802

INSTRUCTIONS

MODEL AVO-6C-C PULSE GENERATOR

S.N. :

WARRANTY

Avtech Electrosystems Ltd. warrants products of its manufacture to be free from defects in material and workmanship under conditions of normal use. If, within one year after delivery to the original owner, and after prepaid return by the original owner, this Avtech product is found to be defective, Avtech shall at its option repair or replace said defective item. This warranty does not apply to units which have been disassembled, modified or subjected to conditions exceeding the applicable specifications or ratings. This warranty is the extent of the obligation or liability assumed by Avtech with respect to this product and no other warranty or guarantee is either expressed or implied.

Fig. 1

PULSE GENERATOR TEST ARRANGEMENT

(AVO-6C-T OUTPUT MODULE REMOVED)

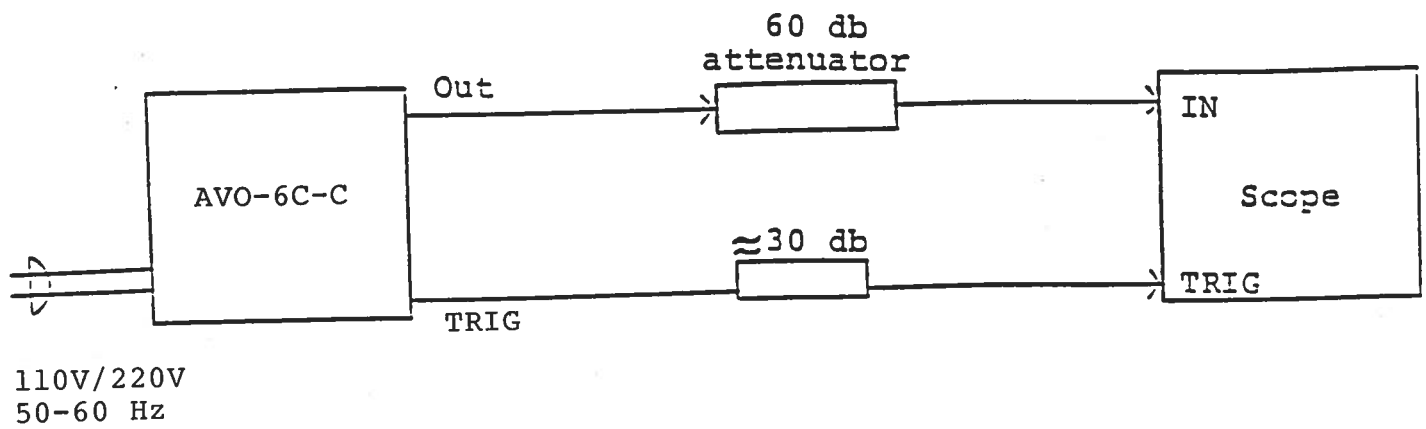

Notes:

- 1) The bandwidth capability of components and instruments used to display the pulse generator output signal (attenuators, cables, connectors, etc.) should exceed 500 MHz.
- 2) The use of 60 dB attenuator at the scope vertical input channel will insure a peak input signal to the scope of less than one Volt (necessary only if sampling scope used). If a high impedance real time scope is used, the pulse generator should be terminated using a shunt 50 Ohm resistor.
- 3) The TRIG output channel provides TTL level signals. To avoid overdriving the TRIG input channel of some scopes, a 30 dB attenuator should be placed at the input to the scope trigger channel. The TRIG output precedes the main output when the front panel ADVANCE-DELAY switch is in the ADVANCE position. The TRIG output lags the main output when the switch is in the DELAY position.
- 4) To obtain a stable output display the PW and PRF controls on the front panel should be set mid range. The front panel TRIG toggle switch should be in the INT position. The DELAY controls and the scope triggering controls are then adjusted to obtain a stable output. The scope may then be used to set the desired PRF by rotating the PRF controls.
- 5) The output pulse width is controlled by means of the front panel one turn PW control and the two-position range switch as follows:

50 - 500 ns
0.5 - 5.0 ns
- 6) The output amplitude is controlled by means of the front panel one turn AMP control.
- 7) MONITOR Option. The rear panel M output port provides a coincident attenuated (x10) replica of the voltage pulse applied to the input of the AVO-6C-T module. The output voltage V_M (Volts) and the diode current I_D (Amps) are related as follows:

$$I_D = \frac{10 V_M - V_f}{40}$$

V_f = laser diode ON voltage, typically 2 Volts.

- 8) **CAUTION:** The output duty cycle must not exceed 1%. For example, for pulse width of less than 1 us, the PRF may be as high as 10 kHz. However, for pulse width of 5 us, the PRF must not exceed 2 kHz.
- 9) AVO-6C units with a serial number higher than 5600 are protected by an automatic overload protective circuit which controls the front panel overload light. If the unit is overloaded (by operating at an exceedingly high duty cycle or by operating into a short circuit), the protective circuit will turn the output of the instrument OFF and turn the indicator light ON. The light will stay ON (i.e. output OFF) for about 5 seconds after which the instrument will attempt to turn ON (i.e. light OFF) for about 1 second. If the overload condition persists, the instrument will turn OFF again (i.e. light ON) for another 5 seconds. If the overload condition has been removed, the instrument will turn on and resume normal operation. Overload conditions may be removed by:
 - 1) Reducing PRF (i.e. switch to a lower range)
 - 2) Reducing pulse width (i.e. switch to a lower range)
 - 3) Removing output load short circuit (if any)
- 10) An external clock may be used to control the output PRF of the AVO unit by setting the front panel TRIG toggle switch in the EXT position and applying a 50 ns (or wider) TTL level pulse to the TRIG BNC connector input. For operation in this mode, the scope time base must also be triggered by the external clock rather than from the TRIG output.
- 11) The unit can be converted from 110 to 220V 50-60 Hz operation by adjusting the voltage selector card in the rear panel fused voltage selector-cable connector assembly.
- 12) For additional assistance:

Tel: (613) 226-5772
Fax: (613) 226-2802

Fig. 2

PULSE GENERATOR TEST ARRANGEMENT
(AVO-6C-T OUTPUT MODULE CONNECTED)

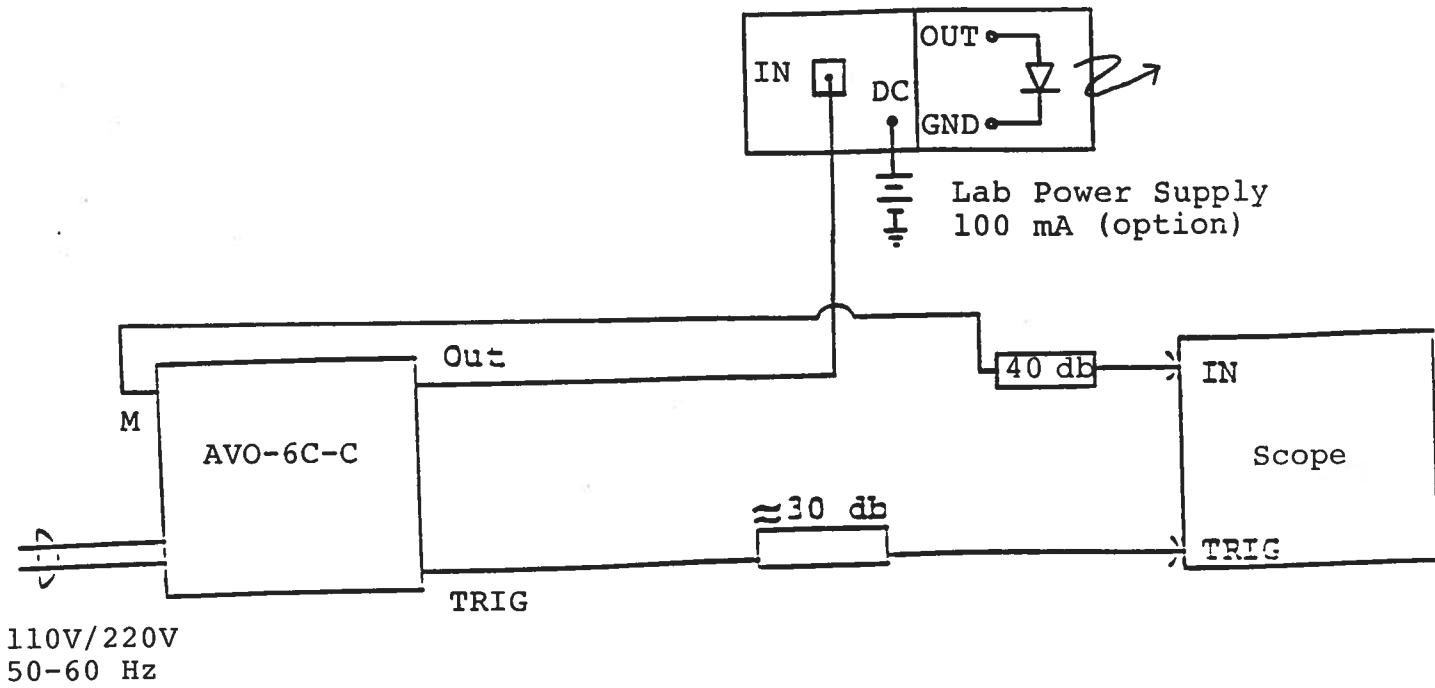

- 1) A general description of the AVO-6C-T module is given in Fig. 3.
- 2) The AVO-6C-T module should be connected to the AVO-6C-C mainframe via the supplied 24" RG174 cable.
- 3) The laser diode is solder-connected between the OUT and GND terminals on the side of the AVO-6C-T module.
- 4) The mainframe provides a voltage pulse of up to 210 Volts to the 40 Ohms in series with the laser diode in the AVO-6C-T module (to provide a maximum current of 5 Amperes).
- 5) A forward DC bias may be applied to the laser diode by connecting a DC potential of 0 to +5 Volts to the DC solder terminal. The application of a small forward bias often yields a more ideal diode current waveform. Note that the DC port must be shorted to ground if a bias is not applied (option).
- 6) The M out port (on the mainframe) provides a voltage pulse (V_M) which is 0.1 of the amplitude of the voltage pulse applied to the input of the AVO-6C-T module. The voltage V_M (Volts) and diode current I_D (Amps) are related as follows:

$$I_D = \frac{10 V_M - V_f}{40}$$

V_f = laser diode ON voltage, typically 2 Volts.

- 7) The diode current may be monitored by means of a current probe or by placing a 1 Ohm resistor in series with the diode (to ground) and monitoring the voltage across the resistor.

- 8) SMA Option. An SMA connector replaces the output solder terminal. Note that the cable placed on this connector (and leading to the diode), must be very short (less than a few cm; eg. 10 cm).

Fig. 3

AVO-6C-T

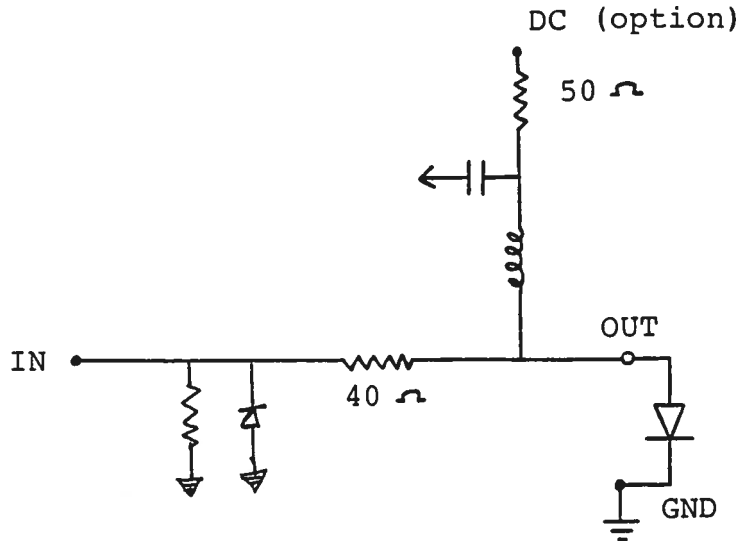

FUNCTIONAL EQUIVALENT CIRCUIT

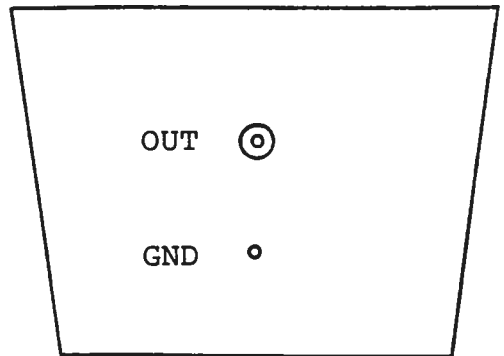
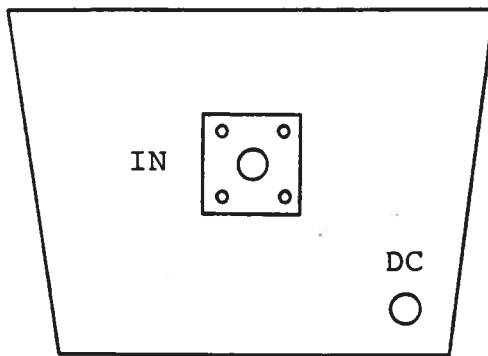

PACKAGE

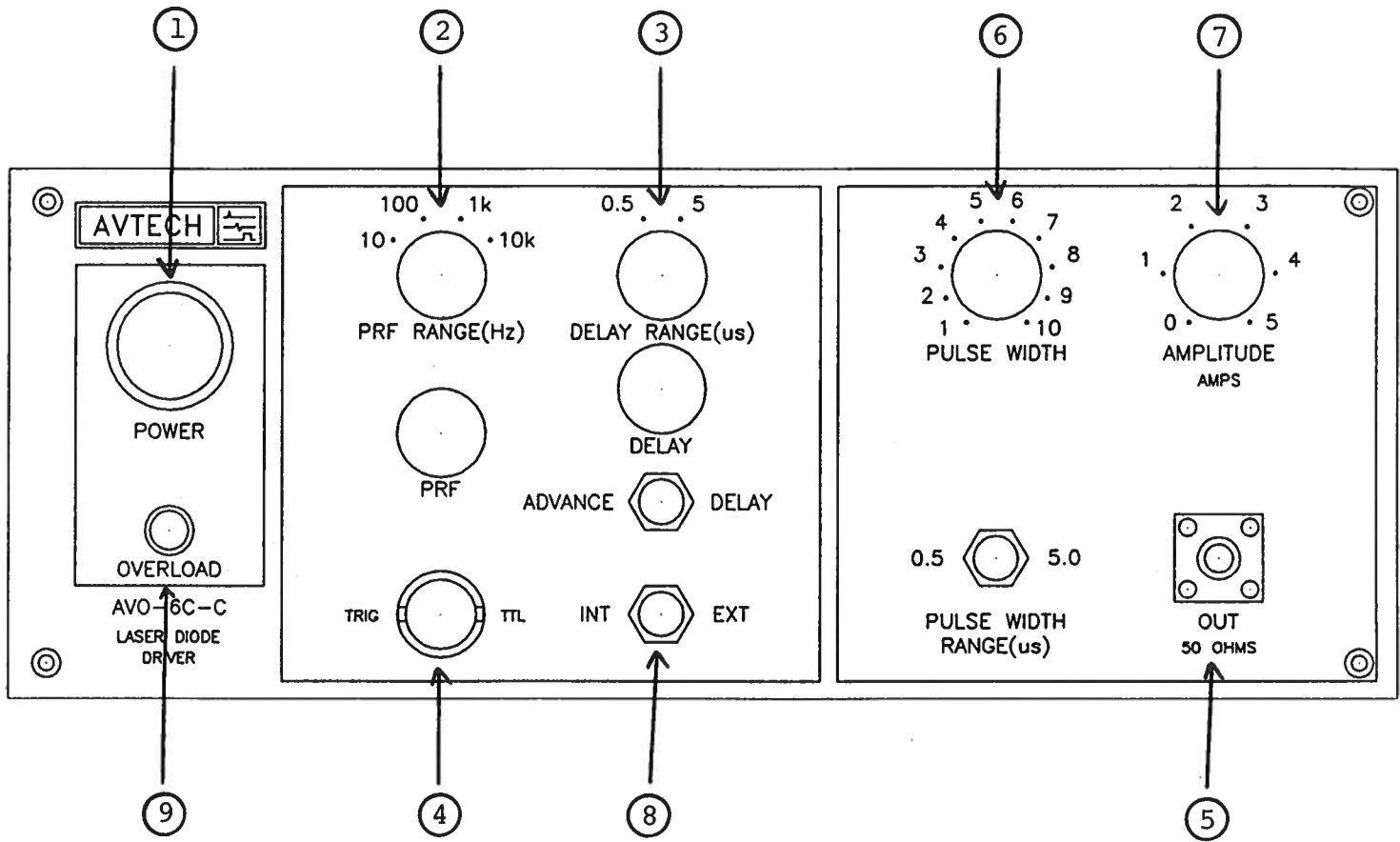

Fig. 4

FRONT PANEL CONTROLS

- (1) ON-OFF Switch. Applies basic prime power to all stages.
- (2) PRF Control. Varies PRF from 1 Hz to 10 kHz as follows:

Range 1	1 Hz	10 Hz
Range 2	10 Hz	to 100 Hz
Range 3	100 Hz	to 1 kHz
Range 4	1 kHz	to 10 kHz
- (3) DELAY Control. Controls the relative delay between the reference output pulse provided at the TRIG output (4) and the main output (5). This delay is variable over the range of 0 to about 1.0 us (Range 1) or 1.0 to 5.0 us (Range 2). The TRIG output precedes the main output when the ADVANCE-DELAY switch is in the ADVANCE position and lags when the switch is in the DELAY position.
- (4) TRIG Output. This output is used to trigger the scope time base. The output is a TTL level 100 ns (approx.) pulse capable of driving a fifty Ohm load.
- (5) OUT Connector. SMA connector provides output to AVO-6C-T module (200 Volts to 40 Ohms).
- (6) PW Control. A pot control and two-position range switch which vary the output pulse width from 50 ns to 0.5 us and 0.5 us to 5.0 us. CAUTION: The output duty cycle must not exceed 1%. For example, for pulse width of less than 1 us, the PRF may be as high as 10 kHz. However, for pulse width of 5 us, the PRF must not exceed 2 kHz.
- (7) AMP Control. A pot control which varies the output pulse amplitude from 0 to 200 V to a 40 Ohm load.
- (8) EXT-INT Control. With this toggle switch in the INT position, the PRF of the AVO unit is controlled via an internal clock which in turn is controlled by the PRF controls. With the toggle switch in the EXT position, the AVO unit requires a 50 ns (or wider) TTL level pulse applied at the TRIG input in order to trigger the output stages. In addition, in this mode, the scope time base must be triggered by the external trigger source.

(9) OVERLOAD INDICATOR. AVO units with a serial number higher than 5600 are protected by an automatic overload protective circuit which controls the front panel overload light. If the unit is overloaded (by operating at an exceedingly high duty cycle or by operating into a short circuit), the protective circuit will turn the output of the instrument OFF and turn the indicator light ON. The light will stay ON (i.e. output OFF) for about 5 seconds after which the instrument will attempt to turn ON (i.e. light OFF) for about 1 second. If the overload condition persists, the instrument will turn OFF again (i.e. light ON) for another 5 seconds. If the overload condition has been removed, the instrument will turn on and resume normal operation. Overload conditions may be removed by:

- 1) Reducing PRF (i.e. switch to a lower range)
- 2) Reducing pulse width (i.e. switch to a lower range)
- 3) Removing output load short circuit (if any)

Fig. 5

BACK PANEL CONTROLS

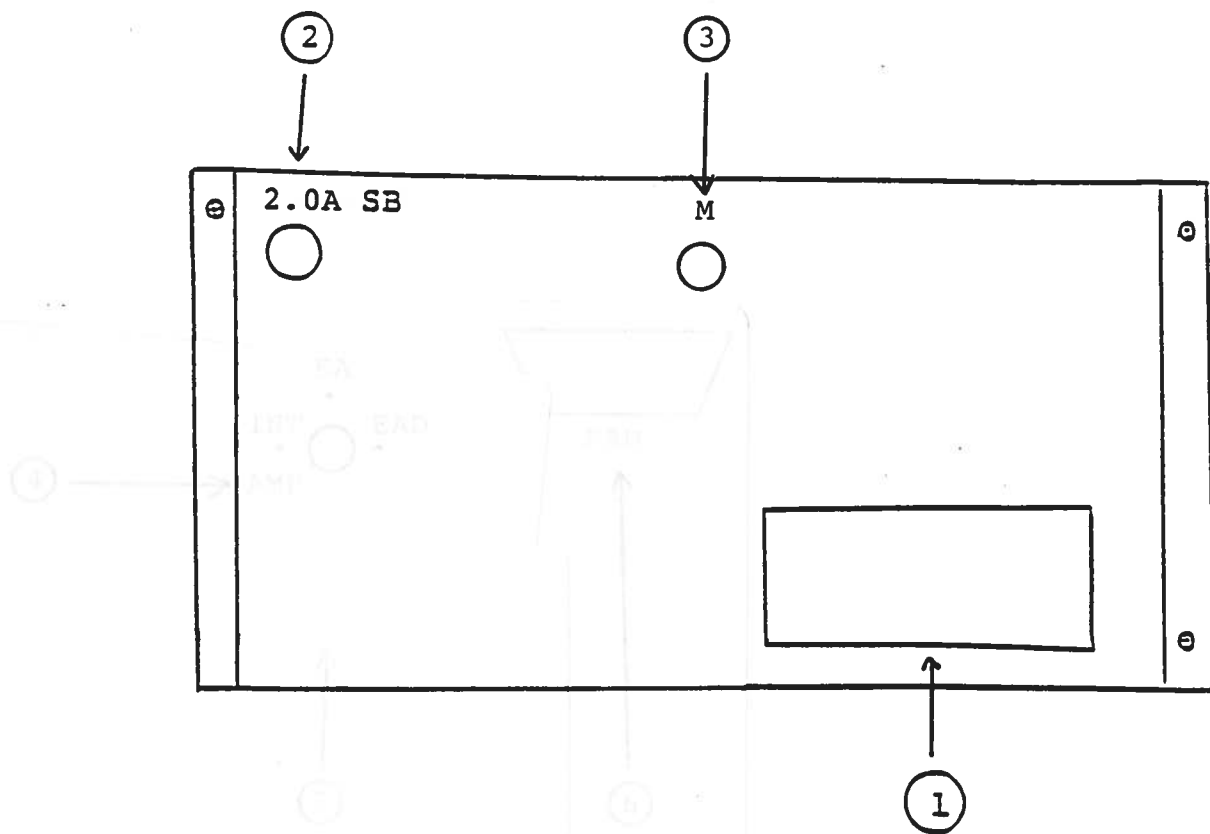

- (1) FUSED CONNECTOR, VOLTAGE SELECTOR. The detachable power cord is connected at this point. In addition, the removable cord is adjusted to select the desired input operating voltage. The unit also contains the main power fuse (0.5 A SB).
- (2) 2.0A SB. Fuse which protects the output stage if the output duty cycle rating is exceeded.
- (3) MONITOR Option. The M output provides a coincident attenuated (x10) replica of the voltage pulse applied to the input of the AVO-6C-T module. The output voltage V_M (Volts) and the diode current I_D (Amps) are related as follows:

$$I_D = \frac{10 V_M - V_f}{40}$$

V_f = laser diode ON voltage, typically 2 Volts.

SYSTEM DESCRIPTION AND REPAIR PROCEDURE

The AVO-6C-C consists of the following basic modules:

- 1) AVO-6C-PG pulse generator module
- 2) AVO-CL2 clock module
- 3) +24V power supply board
- 4) AVO-PS-15 power supply module
- 5) AVO-OL overload module
- 6) DAC-EA control module
- 7) AVO-6C-T output module

The modules are interconnected as shown in Fig. 5. The clock module controls the output PRF and the relative delay between the main output and the TRIG outputs. The PG pulse generator module generates the output pulse. In the event of an instrument malfunction, it is most likely that the rear panel 2.0A SB fuse or some of the output switching elements (SL4T) may have failed due to an output short circuit condition or to a high duty cycle condition. The switching elements may be accessed by removing the cover plate on the bottom side of the instrument. NOTE: First turn off the prime power. The elements may be removed from their sockets by means of a needle nosed pliers. The SL4T is a selected VMOS power transistor in a TO 220 packages and may be checked on a curve tracer. If defective, replacement units should be ordered directly from Avtech. When replacing the SL4T switching elements, take care to insure that the short lead (of the three leads) is adjacent to the black dot on the chassis. If the switching elements are not defective, then the four Phillips screws on the back panel should be removed. The top cover may then be slid off and operation of the clock and power supply modules should be checked. The clock module is functioning properly if:

- a) 0.1 us TTL level outputs are observed at pins 2 and 3.
- b) The PRF of the outputs can be varied over the range of 1 Hz to 10 kHz using the PRF controls.
- c) The relative delay between the pin 2 and 3 outputs can be varied by at least 5 us by the DELAY controls.

The sealed clock module must be returned to Avtech for repair or replacement if the above conditions are not observed. The power supply board generates +24V DC to power the other modules. If the voltage is less than +24V, turn off the prime power and unsolder the lead from the 7824 regulator chip on the power supply board. Solder a 100 Ohm 5 Watt resistor to the 7824 output to ground and turn on the prime power. A voltage of +24 Volts should be read. If the voltage is less then the power supply board is defective and should be repaired or replaced.

March 28/96

-M

Disk: FVO-6

Name: 6CC.INS