



**AVTECH ELECTROSYSTEMS LTD.**

NANOSECOND WAVEFORM ELECTRONICS  
SINCE 1975

P.O. BOX 265  
OGDENSBURG, NY  
U.S.A. 13669-0265

TEL: 888-670-8729 (USA & Canada) or +1-613-226-5772 (Intl)  
FAX: 800-561-1970 (USA & Canada) or +1-613-226-2802 (Intl)

info@avtechpulse.com - <http://www.avtechpulse.com/>

BOX 5120, LCD MERIVALE  
OTTAWA, ONTARIO  
CANADA K2C 3H4

## INSTRUCTIONS

MODEL AVPP-1-C

0 TO 10 VOLTS, 1 MHz

HIGH SPEED PULSE GENERATOR

WITH 100 ps RISE TIME

SERIAL NUMBER: \_\_\_\_\_

### WARRANTY

Avtech Electrosystems Ltd. warrants products of its manufacture to be free from defects in material and workmanship under conditions of normal use. If, within one year after delivery to the original owner, and after prepaid return by the original owner, this Avtech product is found to be defective, Avtech shall at its option repair or replace said defective item. This warranty does not apply to units which have been disassembled, modified or subjected to conditions exceeding the applicable specifications or ratings. This warranty is the extent of the obligation assumed by Avtech with respect to this product and no other warranty or guarantee is either expressed or implied.

### TECHNICAL SUPPORT

Phone: 888-670-8729 (USA & Canada) or +1-613-226-5772 (Intl)

Fax: 800-561-1970 (USA & Canada) or +1-613-226-2802 (Intl)

E-mail: [info@avtechpulse.com](mailto:info@avtechpulse.com)

World Wide Web: <http://www.avtechpulse.com>

## TABLE OF CONTENTS

<b>WARRANTY.....</b>	<b>2</b>
<b>TECHNICAL SUPPORT.....</b>	<b>2</b>
<b>TABLE OF CONTENTS.....</b>	<b>3</b>
<b>INTRODUCTION.....</b>	<b>5</b>
<b>AVAILABLE OPTIONS.....</b>	<b>5</b>
<b>SPECIFICATIONS.....</b>	<b>6</b>
<b>EUROPEAN REGULATORY NOTES.....</b>	<b>7</b>
<b>EC DECLARATION OF CONFORMITY.....</b>	<b>7</b>
<b>DIRECTIVE 2002/95/EC (RoHS).....</b>	<b>7</b>
<b>DIRECTIVE 2002/96/EC (WEEE).....</b>	<b>7</b>
<b>INSTALLATION.....</b>	<b>9</b>
<b>VISUAL CHECK.....</b>	<b>9</b>
<b>POWER RATINGS.....</b>	<b>9</b>
<b>CONNECTION TO THE POWER SUPPLY.....</b>	<b>9</b>
<b>PROTECTION FROM ELECTRIC SHOCK.....</b>	<b>10</b>
<b>ENVIRONMENTAL CONDITIONS.....</b>	<b>10</b>
<b>FUSES.....</b>	<b>12</b>
<b>AC FUSE REPLACEMENT.....</b>	<b>12</b>
<b>DC FUSE REPLACEMENT.....</b>	<b>13</b>
<b>FUSE RATINGS.....</b>	<b>13</b>
<b>FRONT PANEL CONTROLS.....</b>	<b>14</b>
<b>REAR PANEL CONTROLS.....</b>	<b>16</b>
<b>GENERAL INFORMATION.....</b>	<b>18</b>
<b>BASIC TEST ARRANGEMENT.....</b>	<b>18</b>
<b>BASIC PULSE CONTROL.....</b>	<b>18</b>
<b>AMPLITUDE / PULSE WIDTH INTERACTION.....</b>	<b>19</b>
<b>POLARITY INVERSION (for units without the -OT or -EO options).....</b>	<b>20</b>
<b>POLARITY INVERSION (for units with the -OT or -EO options).....</b>	<b>20</b>
<b>OPERATION AT LOW AMPLITUDES.....</b>	<b>20</b>
<b>OSCILLOSCOPE SELECTION AND BANDWIDTH ISSUES.....</b>	<b>20</b>
<b>MINIMIZING WAVEFORM DISTORTIONS.....</b>	<b>22</b>
<b>USE 50Ω TRANSMISSION LINES AND LOADS.....</b>	<b>22</b>

<b>USE LOW-INDUCTANCE LOADS.....</b>	<b>22</b>
<b><i>PREVENTING DAMAGE.....</i></b>	<b>22</b>
<b><i>MECHANICAL INFORMATION.....</i></b>	<b>23</b>
<b>TOP COVER REMOVAL.....</b>	<b>23</b>
<b>RACK MOUNTING.....</b>	<b>23</b>
<b>ELECTROMAGNETIC INTERFERENCE.....</b>	<b>23</b>
<b><i>MAINTENANCE.....</i></b>	<b>24</b>
<b>REGULAR MAINTENANCE.....</b>	<b>24</b>
<b>CLEANING.....</b>	<b>24</b>
<b><i>WIRING DIAGRAMS.....</i></b>	<b>25</b>
<b>WIRING OF AC POWER 1/2.....</b>	<b>25</b>
<b>WIRING OF AC POWER 2/2.....</b>	<b>26</b>
<b>PCB 158K - LOW VOLTAGE POWER SUPPLY, 1/3.....</b>	<b>27</b>
<b>PCB 158K - LOW VOLTAGE POWER SUPPLY, 2/3.....</b>	<b>28</b>
<b>PCB 158K - LOW VOLTAGE POWER SUPPLY, 3/3.....</b>	<b>29</b>
<b>PCB 168B - HIGH VOLTAGE DC POWER SUPPLY.....</b>	<b>30</b>
<b>PCB 126C - OSCILLATOR AND TRIGGER CIRCUIT.....</b>	<b>31</b>
<b>MAIN WIRING - POSITIVE UNITS.....</b>	<b>32</b>
<b><i>PERFORMANCE CHECK SHEET.....</i></b>	<b>33</b>

## INTRODUCTION

The AVPP-1-C is a high performance instrument capable of generating up to 10V into 50Ω loads at repetition rates up to 1 MHz. The output pulse width is variable from 0.2 to 100 ns. The rise time is less than 100 ps. For pulse widths greater than 5 ns, the fall time is < 135 ps. For pulse widths less than 5 ns, the fall time is < 200 ps.

Instruments with the "-P" model suffix can generate 0 to +10V, whereas instruments with the "-N" model suffix can generate 0 to -10V.

Instruments with the "-P-PN" suffix generate 0 to +10V at the main output, and are supplied with an inverting transformer that can be installed on the output to generate a negative signal.

Instruments with the "-N-PN" suffix generate 0 to -10V at the main output, and are supplied with an inverting transformer that can be installed on the output to generate a positive signal.

The output is designed to drive 50Ω loads. (A 50Ω load is required for proper operation.) The output is AC-coupled.

This instrument is intended for use in research, development, test and calibration laboratories by qualified personnel.

## AVAILABLE OPTIONS

The AVPP-1-C is available with several options:

"-AK1" Option: Recommended accessory kit. Consists of three SMA, 18 GHz, 2 Watt attenuators (10, 20 & 30 dB) for use on the output, and two 50 Ohm, 1 GHz, 1 Watt feed-through terminators (one SMA, one BNC) for use on external trigger inputs.

"-OT" Option: this option adds an internally-generated 0 to ±5V DC offset to the main output.

"-EO" Option: the DC offset can be controlled by an externally generated 0 to +10V analog control voltage.

"-EA" Option: the amplitude can be controlled by an externally generated 0 to +10V analog control voltage.

"-EW" Option: the pulse width can be controlled by an externally generated 0 to +10V analog control voltage.

"-M" Option: a monitor output is provided.

## SPECIFICATIONS

Model:	AVPP-1-C <sup>1</sup>
Amplitude <sup>3,4</sup> : (50Ω load)	Variable to 10 Volts
Pulse width <sup>3</sup> :	0.2 to 100 ns
PRF:    internal trigger: external trigger:	100 Hz to 1 MHz 0 to 1 MHz
Rise and fall times <sup>5</sup> : (20%-80%)	$t_{RISE} \leq 100ps,$ $t_{FALL} \leq 135ps,$ except $t_{FALL} \leq 200ps$ for PW < 5ns
Polarity <sup>6,7</sup> :	Positive or negative or both (specify)
Propagation delay:	$\leq 150$ ns (Ext trig in to pulse out)
Jitter:	$\pm 35ps \pm 0.015\%$ of sync delay
DC offset <sup>3,8</sup> :	Apply required DC offset to back panel solder terminals ( $\pm 50$ Volts, 250 mA max)
Trigger required:	Ext trig mode: +5 Volts, 10 ns or wider (TTL)
Sync delay:	Sync out to pulse out: Variable 0 to 200 ns
Sync output:	+3 Volts, 200 ns, will drive 50 Ohm loads
Monitor output option <sup>9</sup> :	Provides a 20 dB attenuated coincident replica of main output
Connectors:	Out: SMA,   Trig: BNC,   Sync: BNC,   Monitor: SMA
Power requirements:	100 - 240 Volts, 50-60 Hz
Dimensions: (H x W x D)	100 mm x 215 mm x 375 mm (3.9" x 8.5" x 14.8")
Chassis material:	cast aluminum frame & handles, blue vinyl on aluminum cover plates
Temperature range:	+5°C to +40°C

- 1) -C suffix indicates stand-alone lab instrument with internal clock and line powering. (See <http://www.avtechpulse.com/formats/> for the basic instrument formats).
- 2) -B suffix indicates IEEE-488.2 GPIB and RS-232 control of amplitude, pulse width, PRF and delay (See <http://www.avtechpulse.com/gpib/>).
- 3) For analog electronic control (0 to +10V) of amplitude, pulse width, or offset, suffix model number with -EA, -EW, or -EO. Electronic control units also include standard front-panel controls. -EW not available on -B units.
- 4) For operation at amplitudes of less than 20% of full-scale, best results will be obtained by setting the amplitude near full-scale and using external attenuators on the output.
- 5) For -C units, add 20% to the rise and fall times if an inverting transformer used.

- 6) For single polarity units, indicate desired polarity by suffixing model number with -P or -N (i.e. positive or negative). For dual-polarity -C units, suffix the model number with -P-PN or -N-PN where the suffix preceding -PN indicates the polarity at the mainframe output port. For dual-polarity -B units, simply add the suffix -PN.
- 7) Polarity inversion in dual-polarity "-C" units is achieved by manually adding a supplied inverting transformer accessory to the main output. The transformer will increase the rise and fall times slightly. Polarity inversion in dual-polarity "-B" units is controlled by front-panel settings (or computer command), and no external transformer is required, and no speed degradation occurs when changing polarities.
- 8) Add -OT to model number for internally generated 0 to  $\pm 5V$  offset option.
- 9) Add -M to model number for monitor option.

## EUROPEAN REGULATORY NOTES

### EC DECLARATION OF CONFORMITY

We            Avtech Electrosystems Ltd.  
               P.O. Box 5120, LCD Merivale  
               Ottawa, Ontario  
               Canada K2C 3H4

declare that this pulse generator meets the intent of Directive 89/336/EEC for Electromagnetic Compatibility. Compliance pertains to the following specifications as listed in the official Journal of the European Communities:

EN 50081-1 Emission

EN 50082-1 Immunity

and that this pulse generator meets the intent of the Low Voltage Directive 72/23/EEC as amended by 93/68/EEC. Compliance pertains to the following specifications as listed in the official Journal of the European Communities:

EN 61010-1:2001 Safety requirements for electrical equipment for measurement, control, and laboratory use



### DIRECTIVE 2002/95/EC (RoHS)

This instrument is exempt from Directive 2002/95/EC of the European Parliament and of the Council of 27 January 2003 on the Restriction of the use of certain Hazardous Substances (RoHS) in electrical and electronic equipment. Specifically, Avtech instruments are considered "Monitoring and control instruments" (Category 9) as defined in Annex 1A of Directive 2002/96/EC. The Directive 2002/95/EC only applies to Directive 2002/96/EC categories 1-7 and 10, as stated in the "Article 2 - Scope" section of Directive 2002/95/EC.

### DIRECTIVE 2002/96/EC (WEEE)

European customers who have purchased this equipment directly from Avtech will have completed a "WEEE Responsibility Agreement" form, accepting responsibility for

WEEE compliance (as mandated in Directive 2002/96/EC of the European Union and local laws) on behalf of the customer, as provided for under Article 9 of Directive 2002/96/EC.

Customers who have purchased Avtech equipment through local representatives should consult with the representative to determine who has responsibility for WEEE compliance. Normally, such responsibilities will lie with the representative, unless other arrangements (under Article 9) have been made.

Requirements for WEEE compliance may include registration of products with local governments, reporting of recycling activities to local governments, and financing of recycling activities.

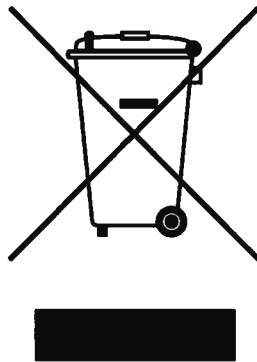



## INSTALLATION

### VISUAL CHECK

After unpacking the instrument, examine to ensure that it has not been damaged in shipment. Visually inspect all connectors, knobs, and handles. Confirm that a power cord and a manual (this manual) are with the instrument. If the instrument has been damaged, file a claim immediately with the company that transported the instrument.

### POWER RATINGS

This instrument is intended to operate from 100 - 240 V, 50 - 60 Hz.

The maximum power consumption is 57 Watts. Please see the "FUSES" section for information about the appropriate AC and DC fuses.

This instrument is an "Installation Category II" instrument, intended for operation from a normal single-phase supply.

### CONNECTION TO THE POWER SUPPLY

An IEC-320 three-pronged recessed male socket is provided on the back panel for AC power connection to the instrument. One end of the detachable power cord that is supplied with the instrument plugs into this socket. The other end of the detachable power cord plugs into the local mains supply. Use only the cable supplied with the instrument. The mains supply must be earthed, and the cord used to connect the instrument to the mains supply must provide an earth connection. (The supplied cord does this.)

 **Warning:** Failure to use a grounded outlet may result in injury or death due to electric shock. This product uses a power cord with a ground connection. It must be connected to a properly grounded outlet. The instrument chassis is connected to the ground wire in the power cord.

The table below describes the power cord that is normally supplied with this instrument, depending on the destination region:

Destination Region	Description	Manufacturer	Part Number
Continental Europe	European CEE 7/7 "Schuko" 230V, 50Hz	Qualtek ( <a href="http://www.qualtekusa.com">http://www.qualtekusa.com</a> )	319004-T01
United Kingdom	BS 1363, 230V, 50Hz	Qualtek ( <a href="http://www.qualtekusa.com">http://www.qualtekusa.com</a> )	370001-E01
Switzerland	SEV 1011, 2 30V, 50Hz	Volex ( <a href="http://www.volex.com">http://www.volex.com</a> )	2102H-C3-10
Israel	SI 32, 220V, 50Hz	Volex ( <a href="http://www.volex.com">http://www.volex.com</a> )	2115H-C3-10
North America, and all other areas	NEMA 5-15, 120V, 60 Hz	Qualtek ( <a href="http://www.qualtekusa.com">http://www.qualtekusa.com</a> )	312007-01

### PROTECTION FROM ELECTRIC SHOCK

 Operators of this instrument must be protected from electric shock at all times. The owner must ensure that operators are prevented access and/or are insulated from every connection point. In some cases, connections must be exposed to potential human contact. Operators must be trained to protect themselves from the risk of electric shock. This instrument is intended for use by qualified personnel who recognize shock hazards and are familiar with safety precautions required to avoid possibly injury. In particular, operators should:

1. Keep exposed high-voltage wiring to an absolute minimum.
2. Wherever possible, use shielded connectors and cabling.
3. Connect and disconnect loads and cables only when the instrument is turned off.
4. Keep in mind that all cables, connectors, oscilloscope probes, and loads must have an appropriate voltage rating.
5. Do not attempt any repairs on the instrument, beyond the fuse replacement procedures described in this manual. Contact Avtech technical support (see page 2 for contact information) if the instrument requires servicing. Service is to be performed solely by qualified service personnel.

### ENVIRONMENTAL CONDITIONS

This instrument is intended for use under the following conditions:

1. indoor use;
2. altitude up to 2 000 m;
3. temperature 5 °C to 40 °C;

4. maximum relative humidity 80 % for temperatures up to 31 °C decreasing linearly to 50 % relative humidity at 40 °C;
5. Mains supply voltage fluctuations up to  $\pm 10$  % of the nominal voltage;
6. no pollution or only dry, non-conductive pollution.

## FUSES

This instrument contains four fuses. All are accessible from the rear-panel. Two protect the AC prime power input, and two protect the internal DC power supplies. The locations of the fuses on the rear panel are shown in the figure below:

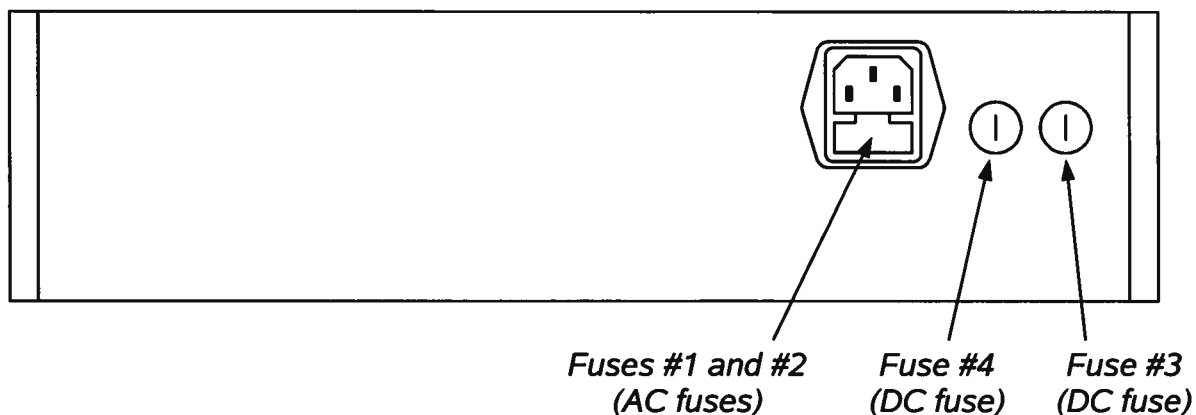

### AC FUSE REPLACEMENT

To physically access the AC fuses, the power cord must be detached from the rear panel of the instrument. The fuse drawer may then be extracted using a small flat-head screwdriver, as shown below:

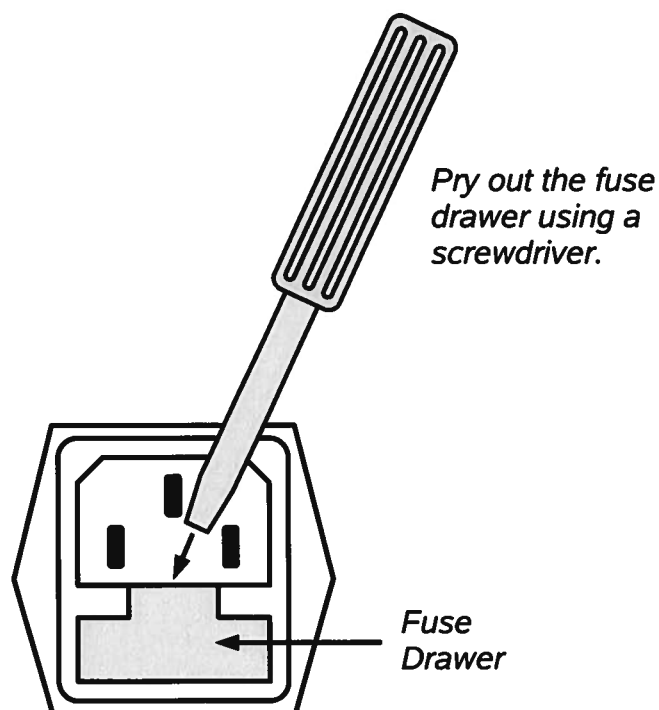

## DC FUSE REPLACEMENT

The DC fuses may be replaced by inserting the tip of a flat-head screwdriver into the fuse holder slot, and rotating the slot counter-clockwise. The fuse and its carrier will then pop out.

## FUSE RATINGS

The following table lists the required fuses:

Fuses	Nominal Mains Voltage	Rating	Case Size	Recommended Replacement Part	
				Littelfuse Part Number	Digi-Key Stock Number
#1, #2 (AC)	100-240V	0.5A, 250V, Time-Delay	5×20 mm	0218.500HXP	F2416-ND
#3 (DC)	N/A	1.6A, 250V, Time-Delay	5×20 mm	021801.6HXP	F2424-ND
#4 (DC)	N/A	0.5A, 250V, Time-Delay	5×20 mm	0218.500HXP	F2416-ND

The recommended fuse manufacturer is Littelfuse (<http://www.littelfuse.com>).

Replacement fuses may be easily obtained from Digi-Key (<http://www.digikey.com>) and other distributors.

## FRONT PANEL CONTROLS

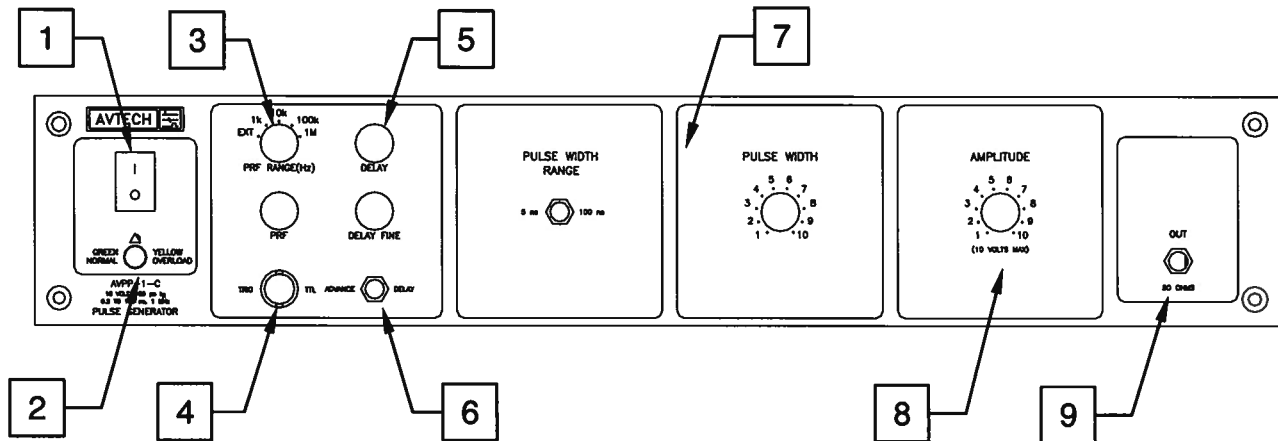

- 1) **POWER Switch**. This is the main power switch. When turning the instrument on, there may be a delay of several seconds before the instrument appears to respond.
- 2) **OVERLOAD Indicator**. When the instrument is powered, this indicator is normally green, indicating normal operation. If this indicator is yellow, an internal automatic overload protection circuit has been tripped. If the unit is overloaded (by operating at an exceedingly high duty cycle or by operating into a very low impedance), the protective circuit will disable the output of the instrument and turn the indicator light yellow. The light will stay yellow (i.e. output disabled) for about 5 seconds after which the instrument will attempt to re-enable the output (i.e. light green) for about 1 second. If the overload condition persists, the output will be disabled again (i.e. light yellow) for another 5 seconds. If the overload condition has been removed, the instrument will resume normal operation.

This overload indicator may flash yellow briefly at start-up. This is not a cause for concern.

- 3) **PRF Range Switch**. This switch sets the pulse repetition frequency (PRF) range of the internal oscillator. The marked value of each position is the upper limit of the 10:1 range, approximately. The vernier dial directly below the switch varies the PRF within the set range.

If this switch is set to the "EXT" position, the instrument is triggered by a signal applied to the TRIG connector, rather than by the internal oscillator.

- 4) **TRIG Connector**. When the PRF Range Switch is set to one of the four internal oscillator ranges, this connector is an output, which supplies a 2V, 200 ns wide pulse for each trigger event. This output may be used to trigger oscilloscopes or other equipment.

When the PRF Range Switch is set to “EXT”, the instrument is triggered by a TTL pulse applied to this connector. The pulse must be at least 50 ns wide. The input impedance of this input is 1 k $\Omega$ .

Depending on the length of cable attached to this input, and the source driving it, it may be desirable to add a coaxial 50 Ohm terminator to this input to provide a proper transmission line termination. The Pasternack ([www.pasternack.com](http://www.pasternack.com)) PE6008-50 BNC feed-thru 50 Ohm terminator is suggested for this purpose. For systems using SMA connectors, the PE6026 SMA feed-thru 50 Ohm terminator is suggested. These terminators are included in the optional -AK1 accessory kit.

- 5) Delay Controls. When the PRF Range Switch is set to one of the four internal oscillator ranges, the main output is advanced or delayed relative to the TRIG output pulse (item 3). The delay is variable up to 500 ns, approximately, using the DELAY and DELAY FINE dials.
- 6) Advance/Delay Switch. When the PRF Range Switch is set to one of the four internal oscillator ranges, this switch determines whether the TRIG output precedes the main output (ADVANCE mode), or whether the TRIG output occurs after the main output (DELAY mode).
- 7) Pulse Width Controls. This dial and switch combination controls the pulse width. There are two switch-selected ranges, of 0.2 to 5 ns, and 5 ns to 100 ns.
- 8) Amplitude Control. This dial controls the pulse amplitude.
- 9) OUT Connector. This connector provides the main output signal, into load impedances of 50 $\Omega$ . (This output *requires* a 50 $\Omega$  load to function properly).
- 10) Offset Control. (Not shown in drawing. Present on -OT and -EO units only). This controls the internally-generated offset feature. The rear-panel “OFFSET ON/OFF” switch must be set to “ON” for this feature to be enabled.

## REAR PANEL CONTROLS

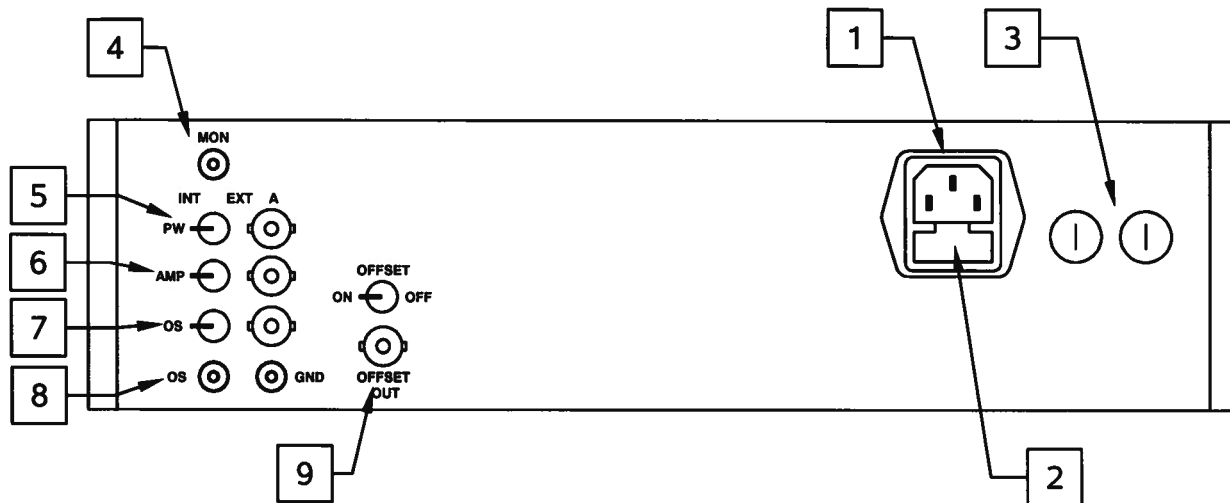

1. **AC POWER INPUT.** An IEC-320 C14 three-pronged recessed male socket is provided on the back panel for AC power connection to the instrument. One end of the detachable power cord that is supplied with the instrument plugs into this socket.
2. **AC FUSE DRAWER.** The two fuses that protect the AC input are located in this drawer. Please see the “FUSES” section of this manual for more information.
3. **DC FUSES.** These two fuses protect the internal DC power supplies. Please see the “FUSES” sections of this manual for more information.
4. **MONITOR Outputs (Optional, -M units only).** Provides an attenuated ( $\div 10$ ) coincident replica (to 50 Ohms) of the main output.
5. **PW INT/EXT SWITCH AND CONNECTOR (Optional, -EW units only).** To control the pulse width of the output with an external DC voltage, set the two-position switch to the EXT position and apply 0 to +10V to the BNC Connector ( $R_{IN} \geq 10 \text{ k}\Omega$ ). When this switch is in the “INT” position, the pulse width is controlled by the front-panel controls.
6. **AMP INT/EXT SWITCH AND CONNECTOR (Optional, -EA units only).** To control the amplitude of the output with an external DC voltage, set the two-position switch to the EXT position and apply 0 to +10V to the BNC Connector ( $R_{IN} \geq 10 \text{ k}\Omega$ ). When this switch is in the “INT” position, the amplitude is controlled by the front-panel controls.
7. **OS INT/EXT SWITCH AND CONNECTOR (Optional, -EO units only).** To control the offset of the output with an external DC voltage, set the two-position switch to the EXT position and apply 0 to +10V to the BNC Connector ( $R_{IN} \geq 10 \text{ k}\Omega$ ). When this switch is in the “INT” position, the offset is controlled by the front-panel controls.



8. OS INPUT (For units without -OT or -EO options). To add a DC offset the output pulse, connect a DC power supply set to the desired offset value to these terminals. The maximum allowable DC offset voltage is  $\pm 50$  Volts. When not used, this input should be connected to the adjacent ground terminal.
  
9. OFFSET ON/OFF SWITCH & OUTPUT (Optional, -EO and -OT units only). This switch enables the offset feature when it is set to "ON". When it is set to "OFF", no offset is added to the output. The internally generated offset is available at the "OFFSET OUT" BNC connector, for monitoring purposes. To add an offset to inverted pulses on AVPP units with the dual polarity option (-PN), connect this terminal to the DC terminal of the AVX-2-T inverting transformer (see the "POLARITY INVERSION" sections in this manual for further details).

## GENERAL INFORMATION

### BASIC TEST ARRANGEMENT

The AVPP-1-C should be tested with a sampling oscilloscope with a bandwidth of at least 10 GHz to properly observe the high-speed waveform. A typical test arrangement is shown below:

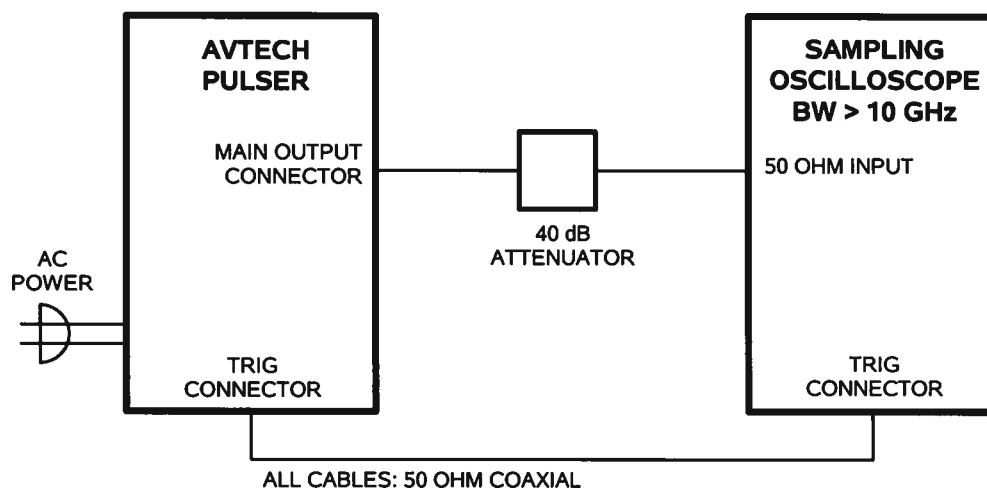

The attenuators are required to prevent damage to the sampling oscilloscope. A 40 dB attenuator with sufficient voltage rating should be used on the main output.

### BASIC PULSE CONTROL

This instrument can be triggered by its own internal clock or by an external TTL trigger signal. When triggered internally, two mainframe output channels respond to the trigger: OUT and SYNC.

- OUT. This is the main output. The maximum output voltage is 10V.
- TRIG. The TRIG pulse is a fixed-width TTL-level reference pulse used to trigger oscilloscopes or other measurement systems.

These pulses are illustrated below:

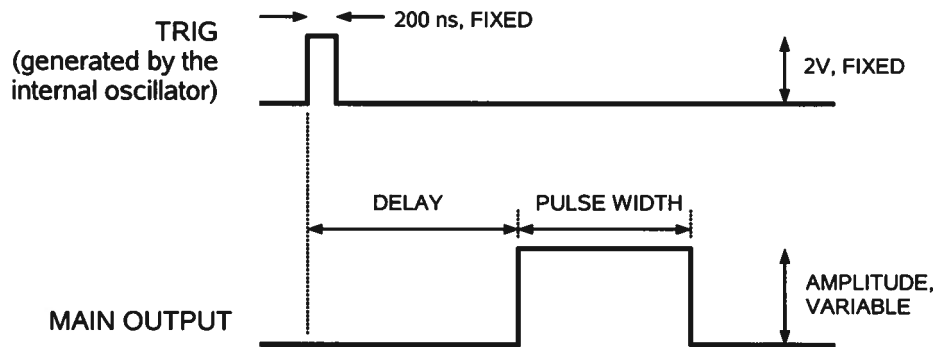

Figure A

When triggered externally, the TRIG connector acts as an input. The delay controls do not function in this mode. Figure B illustrates this mode:

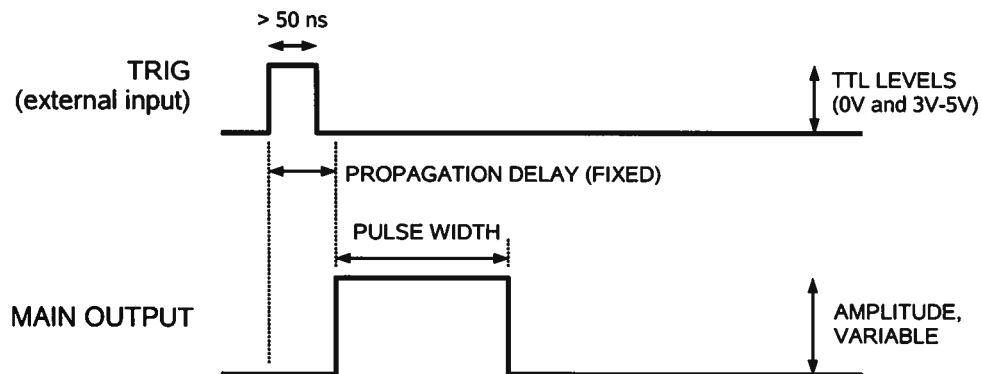

Figure B

### AMPLITUDE / PULSE WIDTH INTERACTION

The output pulse amplitude is controlled by means of the front panel one-turn AMP control. The pulse width may change by several nanoseconds as the output amplitude is reduced from maximum to minimum. Therefore it is convenient to first set the desired amplitude and then set the desired pulse width. Rotation of the PW control causes the position of the falling edge of the pulse to change.

Some properties of the output pulse may change as a function of the amplitude pot setting. For some demanding applications, it may be desirable to use a combination of external attenuators and the amplitude control to achieve the desired output amplitude.

### POLARITY INVERSION (for units without the -OT or -EO options).

To invert the output of the AVPP unit, connect the supplied AVX-2-T inverting transformers to the OUT port. An inverted pulse is then obtained at the OUT port of the AVX-2-T unit.

To add an offset to the inverted pulse, apply the required DC level to the DC terminal of the AVX-2-T unit, not to the rear-panel terminal on the mainframe.

### POLARITY INVERSION (for units with the -OT or -EO options).

To invert the output of the AVPP unit, connect the supplied AVX-2-T inverting transformers to the OUT port. An inverted pulse is then obtained at the OUT port of the AVX-2-T unit.

To add an offset to the inverted pulse, connect a lead from the rear-panel "OFFSET OUT" BNC connector to the DC terminal of the AVX-2-T unit. The DC offset at the output of the AVX-2-T unit is then controlled by the front panel OFFSET control.

### OPERATION AT LOW AMPLITUDES

This instrument will generate the best waveforms when operated near maximum amplitude. If amplitudes less than 1/3 of the full-scale value are desired, better results will be obtained if the pulse generator is operated at a higher amplitude, and an attenuator is connected to the output. Avtech recommends the ATT-0444-XX-SMA-02 series of 18 GHz coaxial attenuators from Midwest Microwave, <http://www.midwestmicrowave.com/>. (The "XX" in the part number is replaced with the numeric attenuation value in dB). Three of these attenuators (10 dB, 20 dB, and 30 dB) are included in the optional -AK1 accessory kit.

### OSCILLOSCOPE SELECTION AND BANDWIDTH ISSUES

To observe a signal with a rise time of  $t_R$ , the bandwidth of the oscilloscope must exceed  $1/t_R$ . For the AVPP-1-C,  $1/t_R = 1 / 100 \text{ ps} = 10 \text{ GHz}$ . For best results, the bandwidth of the oscilloscope (and any attenuators and cables used in the measurement system) should exceed 15 GHz.

Most oscilloscopes with suitable bandwidth are "sampling" oscilloscopes, which are more specialized in nature than slower conventional "real-time" oscilloscopes. Most sampling oscilloscopes have a very limited input voltage range ( $\pm 1\text{V}$ , for example). It is essential in these cases to use high-bandwidth attenuators on the input of the oscilloscope, to avoid over-driving or damaging the oscilloscope.

If a high-bandwidth sampling oscilloscope is not available, a slower real-time oscilloscope can be used, but the rising and falling edges will not be accurately

displayed. Significant overshoot and ringing will be observed as a result of the oscilloscope's limited bandwidth. (Contrary to some user's expectations, low-bandwidth oscilloscopes *do not* "round off" the signal like a classic low-pass filter.) These are measurement artifacts, and are not normally present on the actual output.

## MECHANICAL INFORMATION

### TOP COVER REMOVAL

If necessary, the interior of the instrument may be accessed by removing the four Phillips screws on the top panel. With the four screws removed, the top cover may be slid back (and off).

 Always disconnect the power cord and allow the instrument to sit unpowered for 10 minutes before opening the instrument. This will allow any internal stored charge to discharge.

There are no user-adjustable internal circuits. For repairs other than fuse replacement, please contact Avtech ([info@avtechpulse.com](mailto:info@avtechpulse.com)) to arrange for the instrument to be returned to the factory for repair. Service is to be performed solely by qualified service personnel.

 Caution: High voltages are present inside the instrument during normal operation. Do not operate the instrument with the cover removed.

### RACK MOUNTING

A rack mounting kit is available. The -R5 rack mount kit may be installed after first removing the one Phillips screw on the side panel adjacent to the front handle.

### ELECTROMAGNETIC INTERFERENCE

To prevent electromagnetic interference with other equipment, all used outputs should be connected to shielded loads using shielded coaxial cables. Unused outputs should be terminated with shielded coaxial terminators or with shielded coaxial dust caps, to prevent unintentional electromagnetic radiation. All cords and cables should be less than 3m in length.

## MINIMIZING WAVEFORM DISTORTIONS

### USE 50Ω TRANSMISSION LINES AND LOADS

Connect the load to the pulse generator with 50Ω transmission lines (e.g. RG-58 or RG-174 cable).

This instrument requires a 50Ω load for proper operation. It will not properly drive a high-impedance load. The output stage will be damaged if it is operated into an open circuit (or any other high impedance). Failures due to improper output loading are not covered by the warranty.

### USE LOW-INDUCTANCE LOADS

Lenz's Law predicts that for an inductive voltage spike will be generated when the current through an inductance changes. Specifically,  $V_{\text{SPIKE}} = L \times di_{\text{LOAD}}/dt$ , where  $L$  is the inductance,  $i_{\text{LOAD}}$  is the load current change, and  $t$  is time. For this reason, it is important to keep any parasitic in the load low. This means keeping wiring short, and using low inductance components. In particular, wire-wound resistors should be avoided.

## PREVENTING DAMAGE

The AVPP-1-C may fail if triggered at a PRF greater than 1 MHz.

This unit is designed to operate into a load impedance of 50 Ohms and the output stage will be damaged if it is operated into an open circuit (or any other high impedance). Failures due to improper output loading are not covered by the warranty.

The lifetime of the switching elements in the pulse generator module is proportional to the running time of the instrument. For this reason the prime power to the instrument should be turned off when the instrument is not in use.

## MAINTENANCE

### REGULAR MAINTENANCE

This instrument does not require any regular maintenance.

On occasion, one or more of the four rear-panel fuses may require replacement. All fuses can be accessed from the rear panel. See the “FUSES” section for details.

### CLEANING

If desired, the interior of the instrument may be cleaned using compressed air to dislodge any accumulated dust. (See the “TOP COVER REMOVAL” section for instructions on accessing the interior.) No other cleaning is recommended.







# PCB 158K - LOW VOLTAGE POWER SUPPLY, 1/3

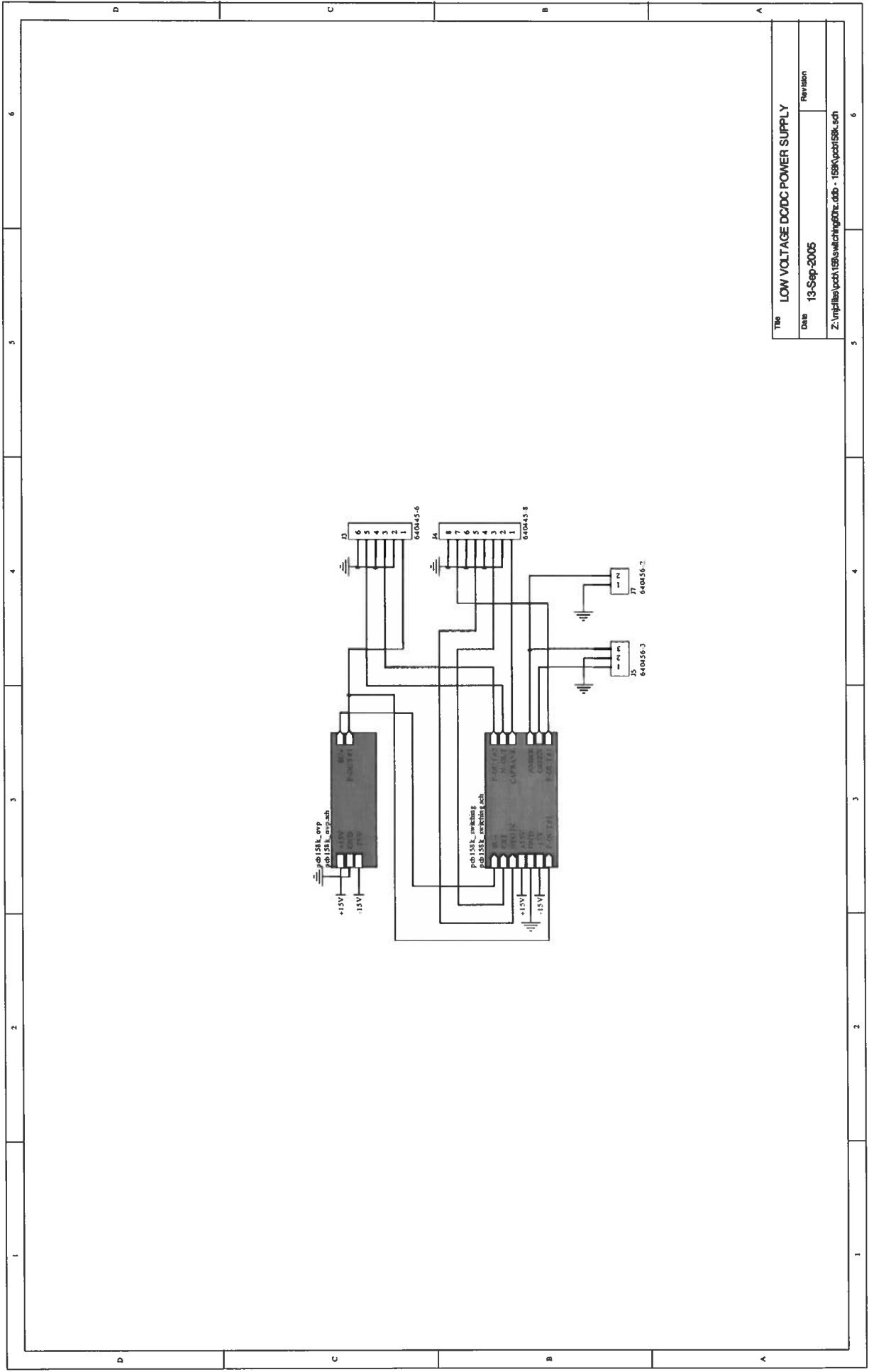

Title	LOW VOLTAGE DC/DC POWER SUPPLY
Date	13-Sep-2005
Revision	
Z:\mpf\files\pcb158\switching001r.ddb - 158K\pcb158k.sch	

# PCB 158K - LOW VOLTAGE POWER SUPPLY, 2/3

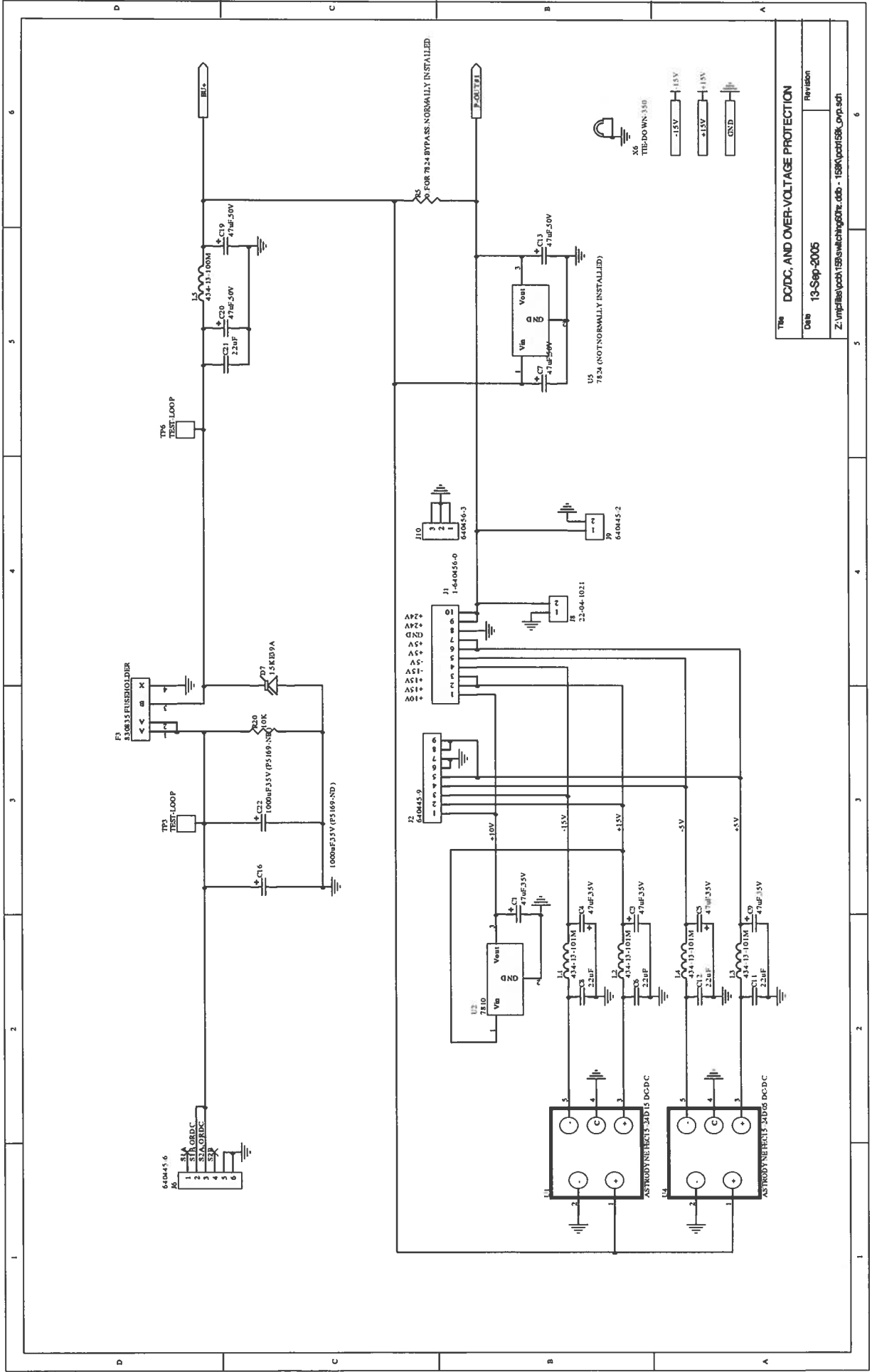

Title	DC/DC, AND OVER-VOLTAGE PROTECTION
Date	13-Sep-2005
Revision	
Z:\mp\flas\pchl158\switching60hz.cdb - 158K\pchl158k_09p.sch	



# PCB 168B - HIGH VOLTAGE DC POWER SUPPLY

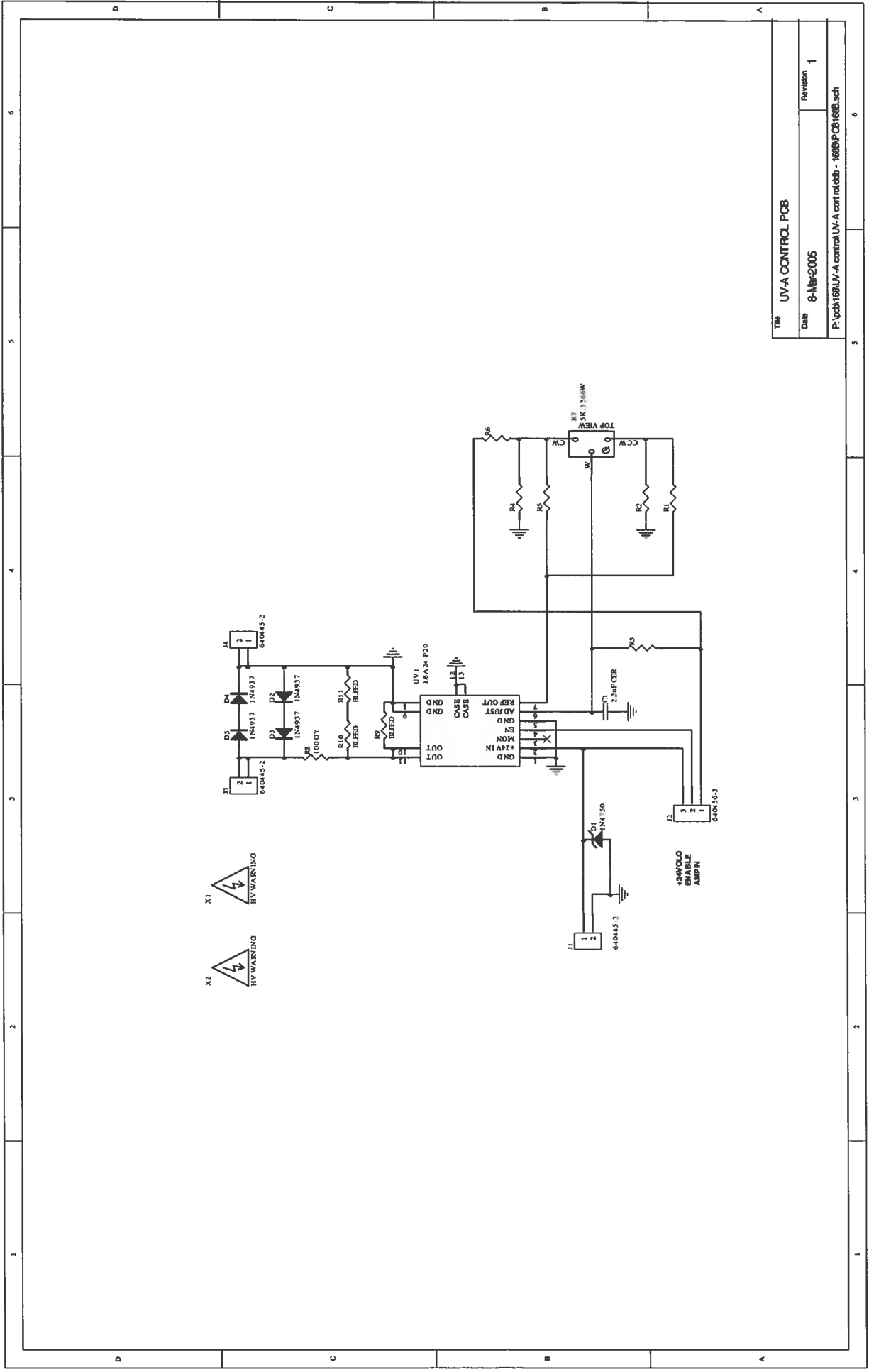

Title	UV-A CONTROL PCB
Date	8-Mar-2005
Revision	1
P:\pcb\168UV-A control UV-A control.ddb - 168BPCB168B.sch	







Aug 1/07