



**AVTECH ELECTROSYSTEMS LTD.**

NANOSECOND WAVEFORM ELECTRONICS  
SINCE 1975

P.O. BOX 265  
OGDENSBURG, NY  
U.S.A. 13669-0265  
TEL: (315) 472-5270  
FAX: (613) 226-2802

TEL: 1-800-265-6681  
FAX: 1-800-561-1970  
U.S.A. & CANADA

e-mail: [info@avtechpulse.com](mailto:info@avtechpulse.com)

BOX 5120 STN. F  
OTTAWA, ONTARIO  
CANADA K2C 3H4  
TEL: (613) 226-5772  
FAX: (613) 226-2802

**INSTRUCTIONS**

**MODEL AVR-5B-C-PN-OP1 PULSE GENERATOR**

**S.N. :**

### WARRANTY

Avtech Electrosystems Ltd. warrants products of its manufacture to be free from defects in material and workmanship under conditions of normal use. If, within one year after delivery to the original owner, and after prepaid return by the original owner, this Avtech product is found to be defective, Avtech shall at its option repair or replace said defective item. This warranty does not apply to units which have been disassembled, modified or subjected to conditions exceeding the applicable specifications or ratings. This warranty is the extent of the obligation or liability assumed by Avtech with respect to this product and no other warranty or guarantee is either expressed or implied.

CONTENTS

A) General Instructions . . . . . Page 2

B) Front Panel Controls . . . . . Page 6

C) Back Panel Controls . . . . . Page 10

D) Top Cover Removal and Rack Mounting . . . . . Page 12

E) System Description and Repair Procedure . . . . . Page 13

F) OP-1 Operating Instructions . . . . . Page 17  
(AN-101-AVR-5B)

G) Performance Check Sheet . . . . . Page 21

Fig. 1

PULSE GENERATOR TEST ARRANGEMENT

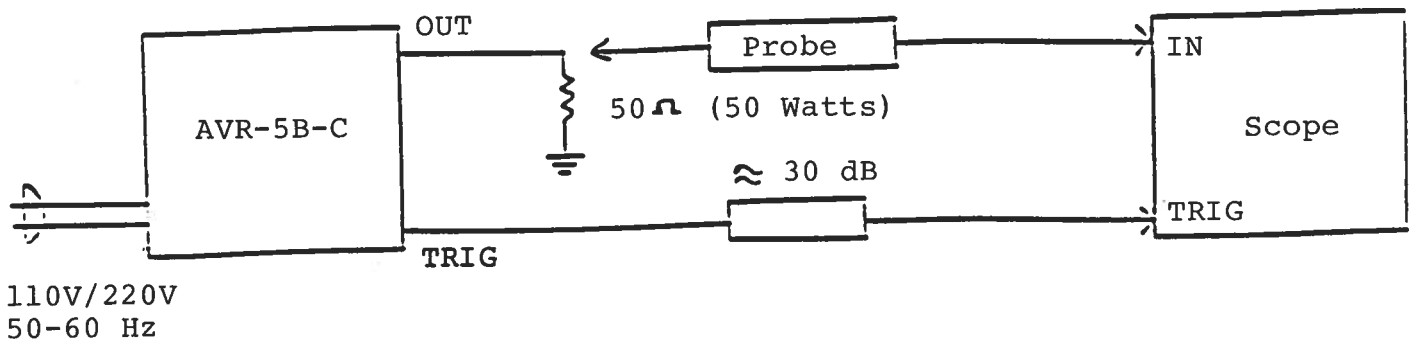

A) GENERAL INSTRUCTIONS

- 1) CAUTION: EXTREME CAUTION SHOULD BE FOLLOWED WHEN USING THIS INSTRUMENT AS IT GENERATES OUTPUT PULSE AMPLITUDES AS HIGH AS 500 VOLTS.
- 2) For front panel manual control of the output parameters, the rear panel LOCAL-REMOTE switch must be in the LOCAL position. For remote control using a personal computer, the switch should be in the REMOTE position. See the AN-101-AVR-5B section (at the end of the manual) for the instructions for this mode of operation. Note that it is recommended that the front panel manual mode be mastered before attempting GPIB control of the instrument.
- 3) The bandwidth capability of components and instruments used to display the pulse generator output signal (attenuators, cables, connectors, etc.) should exceed 100 MHz and must be rated at 50 W, 500 Volts.
- 4) The TRIG output channel provides TTL level signals. To avoid overdriving the TRIG input channel of some scopes, a 30 dB attenuator should be placed at the input to the scope trigger channel. The TRIG output precedes the main output when the front panel ADVANCE-DELAY switch is in the ADVANCE position. The TRIG output lags the main output when the switch is in the DELAY position.

The DELAY control controls the relative delay between the reference output pulse provided at the TRIG output and the main output. This delay is variable over the range of 0.1 us to 100 us.

	MIN	MAX
Range 1	0.1 us	1.0 us
Range 2	1.0 us	10 us
Range 3	10 us	100 us

- 5) The output pulse width is controlled by means of the front panel ten turn PW control and by the PW RANGE control. Note that the MODE switch must be in the INT position. The minimum and maximum PW for each range and the corresponding maximum PRF are as follows. Note that the unit may fail if operated at duty cycles exceeding 1%.

	PW min	PW max
Range 1	0.1 us PRF max 10 kHz	1.0 us PRF max 10 kHz
Range 2	1.0 us PRF max 10 kHz	10 us PRF max 1 kHz
Range 3	10 us PRF max 1 kHz	100 us PRF max 100 Hz

- 6) To obtain a stable output display the PRF control on the front panel should be set mid range. The front panel INT-EXT toggle switch should be in the INT position and the MODE A-B switch should be in the A position. The DELAY controls and the scope triggering controls are then adjusted to obtain a stable output. The scope may then be used to set the desired PRF by rotating the PRF and PRF FINE controls.
- 7) The output pulse amplitude is controlled by means of the front panel ten turn AMP control.
- 8) The output polarity is controlled by the two position polarity switch. Note that the polarity will not change if the output voltage exceeds about 50 Volts. Therefore, rotate the AMP control full CCW before attempting to reverse the polarity. Note when the unit is operating at a low duty cycle and an attempt is made to reduce the output amplitude, the amplitude will decay slowly with a time constant of several tens of seconds. If a rapid decay is required, briefly switch the rear panel HV switch to the "OFF" position (and then back to the "ON" position). It is strongly recommended that before attempting to change the output polarities, the output pulse amplitude be first reduced to zero as this significantly reduces the stressing of the output stage.

- 9) An external clock may be used to control the output PRF of the AVR unit by setting the MODE switch in the EXT position and applying a 50 ns (or wider) TTL level pulse to the TRIG BNC connector input. With the MODE switch in the EXT A position, the output pulse width will be controlled by the front panel PW controls. If the switch is in the MODE B position, the output pulse width equals the input trigger pulse width.
- 10) For single pulse manual operation, set the MODE switch in the MAN position and push the SINGLE PULSE button.
- 11) The AVR-5B-C features an output impedance of the order of several Ohms (rather than 50 Ohms). The following consequences of this feature should be noted:
  - a) When used to switch some semiconductor devices (eg. bipolar and VMOS power transistors), the AVR unit will yield much faster switching times than those provided by 50 Ohm pulse generators.
  - b) The AVR unit will safely operate in to load impedances in the range of 50 Ohms to an open circuit. However, the fall time may degrade for load impedances higher than fifty Ohms.
  - c) The AVR unit may be effectively converted to a fifty Ohm output impedance generator by placing a fifty Ohm carbon composition resistor in series with the output of the unit and the load. The maximum available load voltage will then decrease to 250 Volts (from 500 Volts).
  - d) The output switching elements may fail if the unit is inadvertently operated into a short circuit. The switching elements are easily replaced in the field following the procedure outlined in the REPAIR Section.

- 12) **CAUTION:** The output stage is protected against overload condition by a 2.0 A slow blow fuse on the main frame back panel. However, the output switching elements may fail if the unit is triggered at a PRF exceeding 1 kHz or at duty cycles resulting in an average output power in excess of 50 Watts. Heating and subsequent likely failure of the output stage is reduced if the following action is taken where possible:
- a) PRF is kept to a minimum, i.e. operate in a low PRF range when possible rather than in a high PRF range.
  - b) Keep the output PW to a minimum.
- 13) **OVERLOAD INDICATOR.** AVR-5-C units are protected by an automatic overload protective circuit which controls the front panel overload light. If the unit is overloaded (by operating at an exceedingly high duty cycle or by operating into a short circuit), the protective circuit will turn the output of the instrument OFF and turn the indicator light ON. The light will stay ON (i.e. output OFF) for about 5 seconds after which the instrument will attempt to turn ON (i.e. light OFF) for about 1 second. If the overload condition persists, the instrument will turn OFF again (i.e. light ON) for another 5 seconds. If the overload condition has been removed, the instrument will turn on and resume normal operation. Overload conditions may be removed by:
- 1) Reducing PRF (i.e. switch to a lower range)
  - 2) Reducing pulse width (i.e. switch to a lower range)
  - 3) Removing output load short circuit (if any)
- Note that the output stage will safely withstand a short circuited load condition. The overload light may illuminate when the prime power is applied. The light will extinguish after a few seconds and the unit will then function normally.
- 14) The unit can be converted from 120 to 240V 50-60 Hz operation by adjusting the voltage selector card in the rear panel fused voltage selector cable connector assembly.
- 15) For further assistance:
- Tel: 613-226-5772  
Fax: 613-226-2802



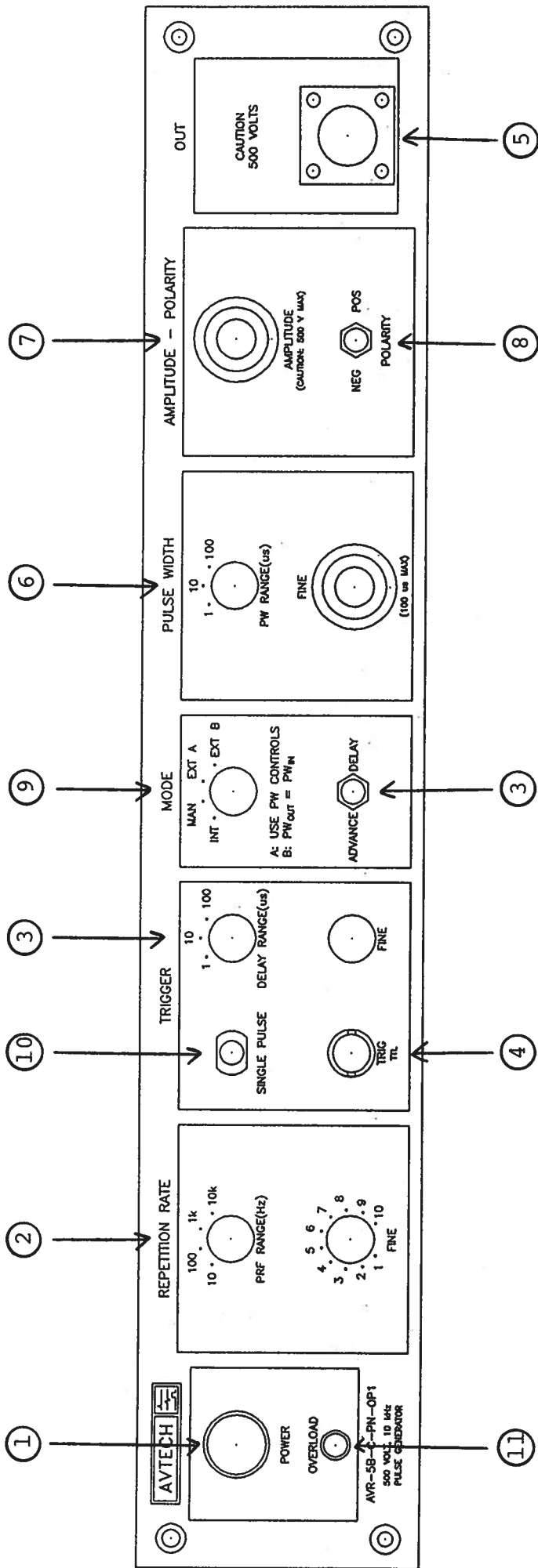

FRONT PANEL CONTROLS

B) FRONT PANEL CONTROLS

- (1) ON-OFF Switch. Applies basic prime power to all stages.
- (2) PRF Control. Varies PRF from 0.1 Hz to 10 kHz as follows:

Range 1	5 Hz	50 Hz
Range 2	20 Hz	200 Hz
Range 3	100 Hz	1 kHz
Range 4	1 kHz	10 kHz

- (3) DELAY Control. Controls the relative delay between the reference output pulse provided at the TRIG output (4) and the main output (5). This delay is variable over the range of 0.1 to about 100 us. Delay LEADS or LAGS depending on the position of the ADVANCE-DELAY switch.

	MIN	MAX
Range 1	0.1 us	1.0 us
Range 2	1.0 us	10 us
Range 3	10 us	100 us

- (4) TRIG Output. This output is used to trigger the scope time base. The output is a TTL level 100 ns (approx.) pulse capable of driving a fifty Ohm load. This output precedes the output at (5) if the two position ADVANCE-DELAY switch is in the ADVANCE position. This output follows the output at (5) if the switch is in the DELAY position. The delay range is variable from 0.1 us to 100 us. The external trigger signal is applied at this input when the MODE toggle switch is in the EXT position.
- (5) OUT Connector. N connector provides output to a 50 Ohm (or higher) load.
- (6) PW Control. A ten turn control and 3 position range switch which varies the output pulse width from 0.1 us to 100 us (when the MODE switch is in the INT position). The minimum and maximum PW for each range and the corresponding maximum PRF are as follows. Note that the unit may fail if operated at duty cycles exceeding 1%.

	PW min	PW max
Range 1	0.1 us PRF max 10 kHz	1.0 us PRF max 10 kHz
Range 2	1.0 us PRF max 10 kHz	10 us PRF max 1 kHz
Range 3	10 us PRF max 1 kHz	100 us PRF max 100 Hz

- (7) AMP Control. A ten turn control which varies the output pulse amplitude from 0 to 500 V.
- (8) POLARITY. The output polarity is controlled by the two-position polarity switch. Note that the polarity will not change if the output voltage exceeds about 50 Volts. Therefore, rotate the AMP control full CCW before attempting to reverse the polarity. Note when the unit is operating at a low duty cycle and an attempt is made to reduce the output amplitude, the amplitude will decay slowly with a time constant of several tens of seconds. If a rapid decay is required, briefly switch the rear panel HV switch to the "OFF" position (and then back to the "ON" position).
- (9) EXT-INT-MAN Control. With the switch in the INT position, the PRF of the AVR unit is controlled via an internal clock which in turn is controlled by the PRF control and the output pulse width is controlled by the front panel controls. With the switch in the EXT A position, the AVR unit requires a 50 ns (or wider) pulse applied at the TRIG input in order to trigger the output stages. In this mode, the output pulse width is controlled by the PW controls. With the MODE switch in the EXT B position, the output pulse width equals the input trigger pulse width. For single pulse operation, set the INT-EXT-MAN switch in the MAN position.
- (10) SINGLE PULSE. For single pulse manual operation, set the front panel INT-EXT-MAN switch in the MAN position and push the SINGLE PULSE button.

(11) OVERLOAD INDICATOR. AVR-5-C units are protected by an automatic overload protective circuit which controls the front panel overload light. If the unit is overloaded (by operating at an exceedingly high duty cycle or by operating into a short circuit), the protective circuit will turn the output of the instrument OFF and turn the indicator light ON. The light will stay ON (i.e. output OFF) for about 5 seconds after which the instrument will attempt to turn ON (i.e. light OFF) for about 1 second. If the overload condition persists, the instrument will turn OFF again (i.e. light ON) for another 5 seconds. If the overload condition has been removed, the instrument will turn on and resume normal operation. Overload conditions may be removed by:

- 1) Reducing PRF (i.e. switch to a lower range)
- 2) Reducing pulse width (i.e. switch to a lower range)
- 3) Removing output load short circuit (if any)

Note that the output stage will safely withstand a short circuited load condition. The overload light may illuminate when the prime power is applied. The light will extinguish after a few seconds and the unit will then function normally.

Fig. 3

C) BACK PANEL CONTROLS

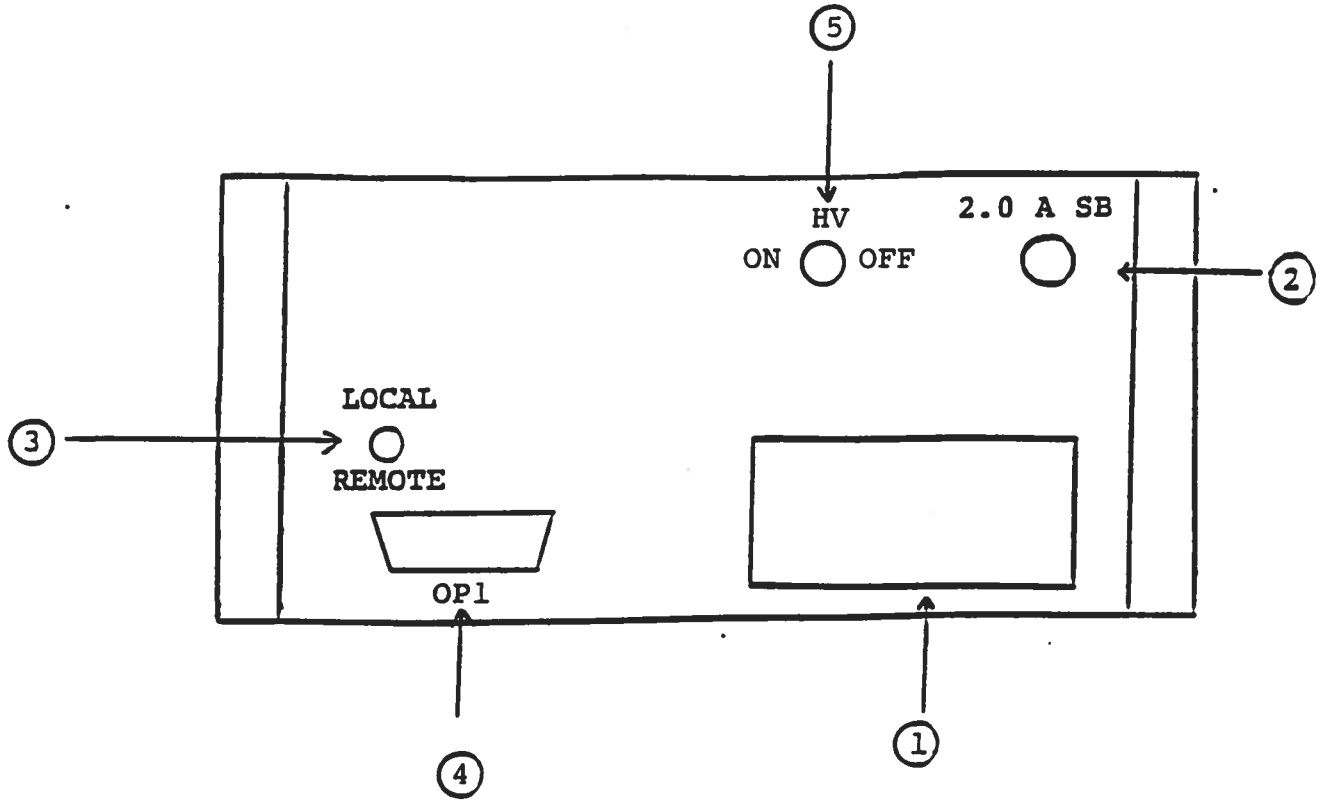

- (1) FUSED CONNECTOR, VOLTAGE SELECTOR. The detachable power cord is connected at this point. In addition, the removable cord is adjusted to select the desired input operating voltage. The unit also contains the main power fuse (1.0 A SB).
- (2) 2.0A SB. Fuse which protects the output stage if the output duty cycle rating is exceeded.
- (3) For front panel manual control of the output parameters, the LOCAL-REMOTE switch must be in the LOCAL position. For remote control using a personal computer, the switch should be in the REMOTE position. See the AN-101-AVR-5B section (at the end of the manual) for the instructions for this mode of operation. Note that it is recommended that the front panel manual mode be mastered before attempting GPIB control of the instrument.
- (4) OP1 CONNECTOR. GPIB cable (supplied) connects between this connector and your personal computer.
- (5) HV ON-OFF. This switch must be in the "ON" position to obtain an output pulse. When prime power is applied to the unit, the output pulse may jump up momentarily to as much as several hundred Volts (even with the amplitude pot set fully CCW). This can be prevented by first setting the HV switch in the "OFF" position and then to the "ON" position after the prime power has been applied.

D) TOP COVER REMOVAL AND RACK MOUNTING

- 1) The interior of the instrument may be accessed by removing the four Phillips screws on the top panel. With the four screws removed, the top cover may be slid back (and off).
- 2) The -R5 rack mount kit may be installed after first removing the one Phillips screw on the side panel adjacent to the front handle.

## E) SYSTEM DESCRIPTION AND REPAIR PROCEDURE

**CAUTION:** Potentials as high as 550 Volts DC are employed in the interior of this instrument so extreme caution must be exercised when attempting repairs. The following parts may be at high potential:

- a) 1C24-PN125 Ultra Volt power supply (and associated leads and capacitors)
- b) PG-P and PG-N pulser modules (and associated leads and capacitors)
- c) POLR module and associated leads

The AVR-5B-PN-C consists of the following basic modules:

- 1) AVR-5B-PG pulse generator modules (P and N)
- 2) 1C24-PN125 power supply module
- 3) AVR-POLR POLR module
- 4) AVR-5B-SW2 polarity modules
- 5) PS-15 Volt power supply
- 6) OL-471 overload module
- 7) +24, +15, +5.0V power supply PCB
- 8) OP1 PCB
- 9) OP12 PCB

The modules are interconnected as shown in Fig. 5.

In the event of an instrument malfunction, it is most likely that the 2.0 A slow blow fuse or the main power fuse on the rear panel has blown. Replace if necessary. If the unit still does not function, it is most likely that some of the output switching elements (IRFPG50) may have failed due to an output short circuit condition or to a high duty cycle condition. The switching elements may be accessed by removing the top cover plate. The cover plate is removed by removing the 4 Phillips screws on the cover panel. **NOTE:** First turn off the prime power. **CAUTION:** Thoroughly ground the IRFPG50 cases to discharge the 550 Volts power supply potential. The IRFPG50 may be removed from the mounting bracket and checked on a curve tracer and replaced if necessary.



Fig. 4

POWER SUPPLY

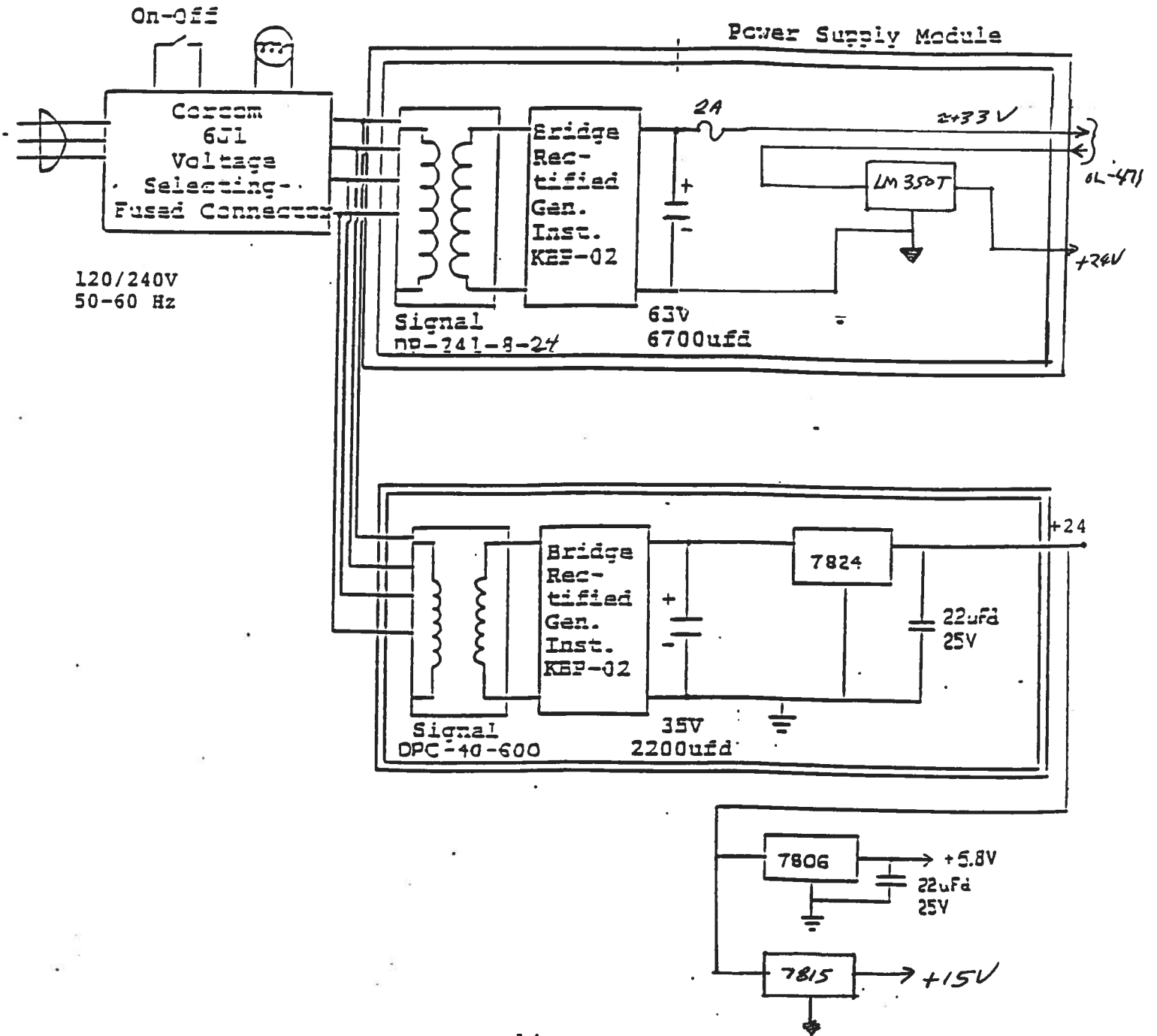

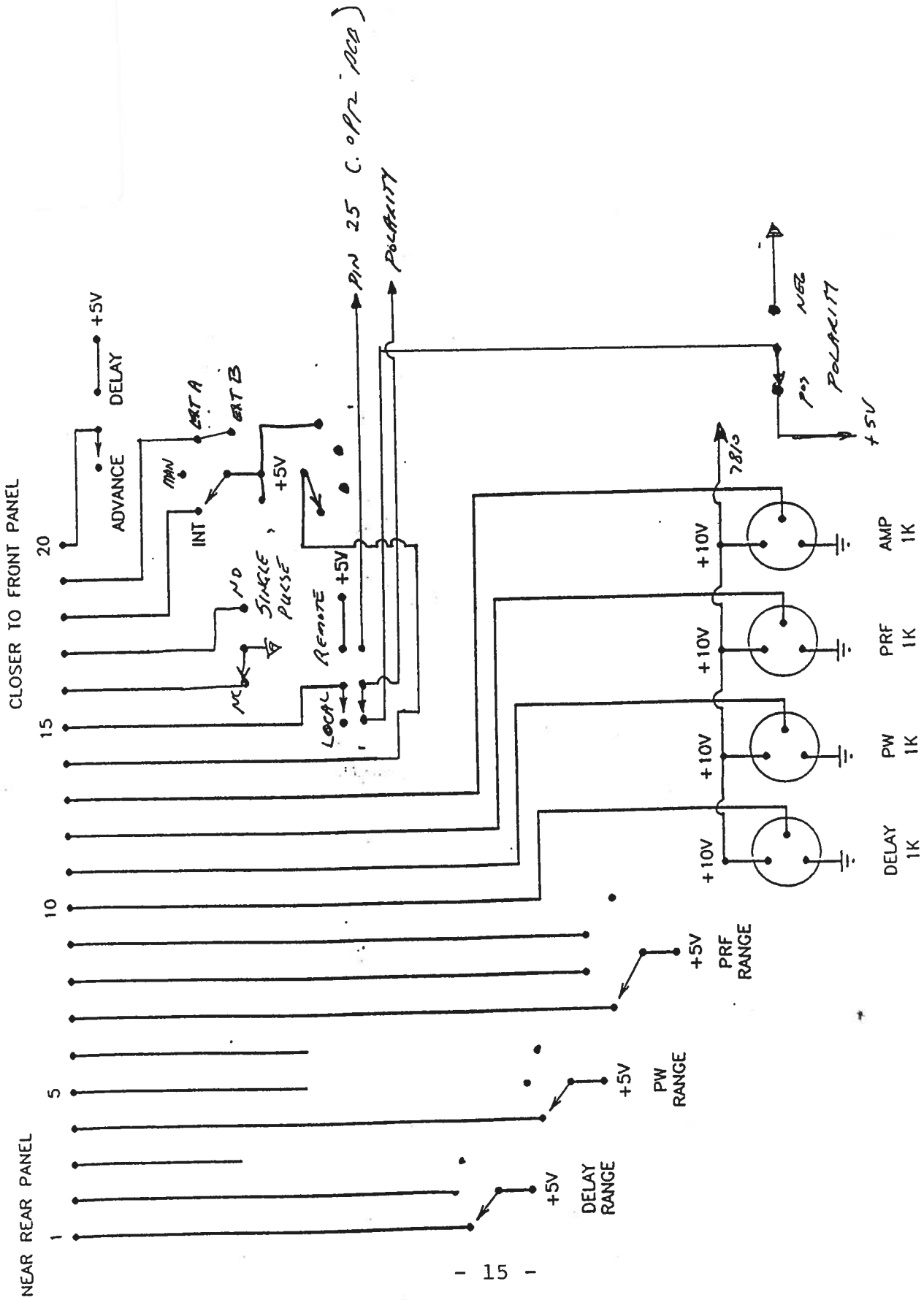

TRIG  \* TO MAIN BOARD

Fig 5A

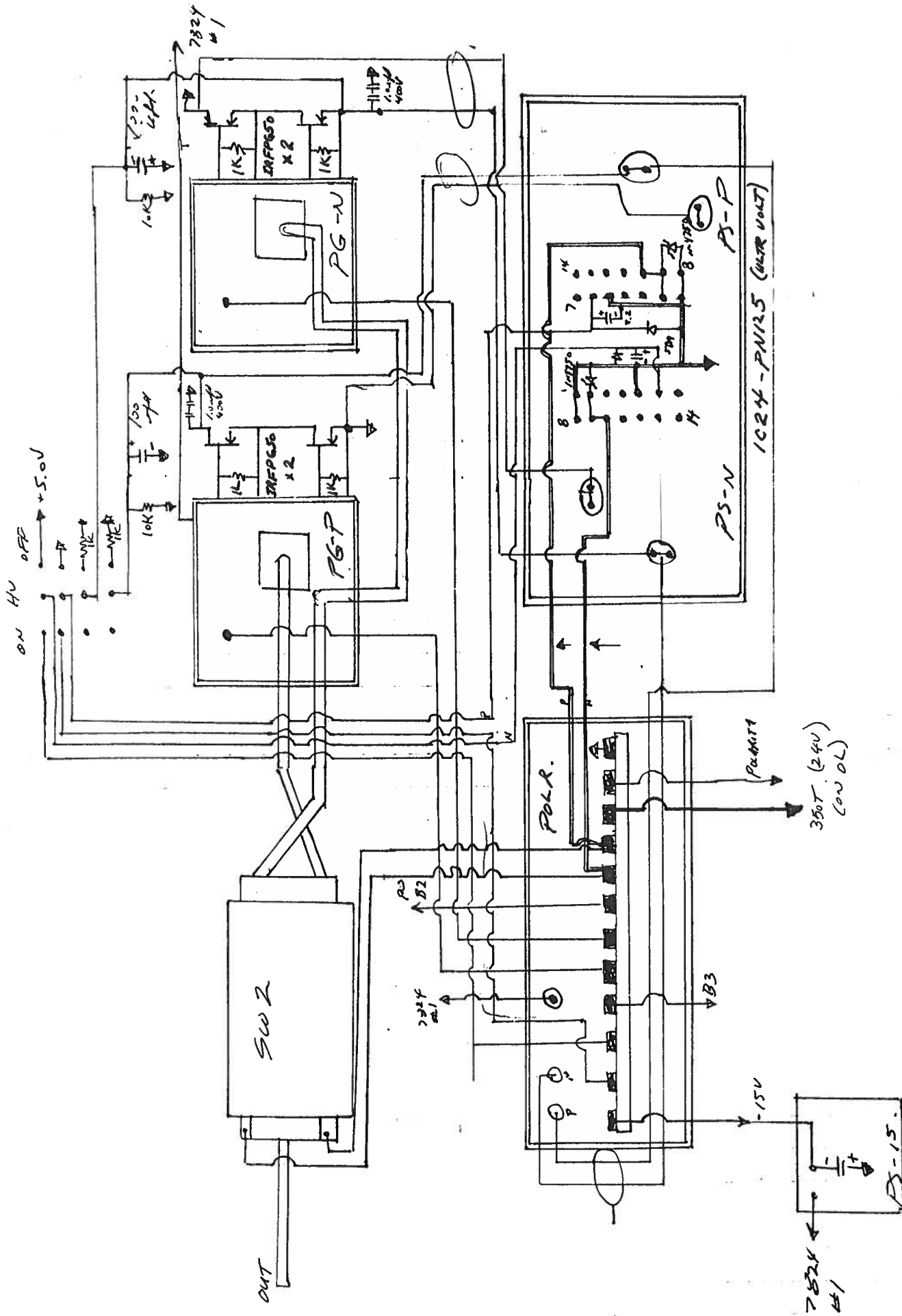

Fig 5.B

# F) OP-1 Operating Instructions (AN-101-AVR-5B)

## 1.0 Introduction

This section describes how to use the OP-1 GPIB Bus Listener interface for remote computer control of the Avtech pulse generator, by means of the IEEE 488 General Purpose Interface Bus (GPIB).

The available commands and their structure, a typical command sequence and a sample program are included.

In addition, possible methods of incorporating remote duty cycle limit checking and instructions on how to change the GPIB address are provided

## 2.0 Interface to the GPIB

The IEEE 488 compatible Bus functions available to the user for GPIB control are as follows: The listed functions define a Bus Listener capability:

- SH0, AH1, T0, TE0, L2, LE0, SR0, RL0, PP0, DC1, DT0, C0.

## 2.1 Available Commands

The OP-1 GPIB user interface is designed to be used to remotely program the Avtech pulse generator to control the pulse repetition rate, pulse width, pulse amplitude and delayed (or advanced) trigger output.

The available command acronyms, outputs, units and range of acceptable values for the AVR-5B-PW-C-PN generator are defined in the table below:

Acronym	Output	Units	Range	Decades
V	Voltage amplitude	Volts	0 to 500	
R	Repetition rate	Hertz	1 to 10000	4
W	Width of pulse	micro-sec	0.1 to 100	3
D	Delay (trigger)	micro-sec	0.1 to 100	3
A	Advance (trigger)	micro-sec	0.1 to 100	3

## OP-1 Operating Instructions

### 2.2 Command Interpretation

The command may utilize the defined single letter acronym, or may be expanded to a longer word to make the control program easier to understand. This is because letters following the defined acronym letter are ignored. For example, a command of "V=2" will cause exactly the same result if the command is sent as "Voltage level of output pulse =2". However, it is mandatory that the first letter of each command be one of the five defined acronyms.

Acronyms are case insensitive, for example, "R" or "r" are the same.

The number following the acronym letter may be any number in the range specified, however, the number of significant digits are limited to one part in 255 (for 8 bits of output resolution). For example, rep rate values of 128.2, 128.3 or 128.2145 will all result in the same output. (Note that output resolution and accuracy are not necessarily the same).

Leading or trailing zeros in numbers will be ignored.

Numbers expressed in "exponential" format will NOT be interpreted correctly. For example, 3e+2 will be interpreted as 3, not as 300.

The range of the specified values must be as specified for the equipment. Numbers outside the range will be ignored.

If desired, trailing text may be added to make the control program easier to understand, since it will be ignored. For example, a command of "delay=0.2" will result in the same output as the command "delay = 0.2 micro-seconds".

The term "Delay" is used to specify the duration of the delay between the trigger output pulse and the occurrence of the actual output pulse. The term "Advance" similarly refers to the amount of time the trigger pulse will occur prior to the output pulse.

If an invalid command is sent, the unit will ignore the command and the previous value will remain unchanged. If an "out-of-range" value is sent, the unit will also ignore the command.

### 2.3 Typical Command Sequence Interpretation

Assume the following commands are sent using the computer, using the appropriate command structure as specified for the user's GPIB controller. Note that the default GPIB address is eight.

```
R=100  
V=50  
A=1  
W=2
```

## OP-1 Operating Instructions

For example, for a GPIB controller from National Instruments, the following set of commands would be sent:

```
ibwrt "r=100"  
ibwrt "v=50"  
ibwrt "a=1"  
ibwrt "w=2"
```

This command sequence will cause the generator to produce an output pulse of width 2 micro-sec and an amplitude of 50 volts peak, repeated at a rate of 100 pulses per second. An oscilloscope attached to the generator output will confirm the result. If the generator output trigger port is used, it will be noted that each output pulse will occur 1 micro-sec after the trigger pulse occurs.

### 2.4 Sample Program

To illustrate the remote control process by means of the GPIB, a sample program written in BASIC is provided. While this example is prepared for use with the B&C MicroSystems PC488 circuit card, the general principles of control apply to any IEEE 488 GPIB Controller.

```
'TEST of Pulser Controller  
OPEN "PC488" FOR OUTPUT AS #1  
PRINT #1, "ABORT"  
PRINT #1, "CLEAR"  
PRINT #1, "OUTPUT 8;V", 50  
PRINT #1, "OUTPUT 8;R", 100  
PRINT #1, "OUTPUT 8;A",1  
PRINT #1, "OUTPUT 8;W",2  
END
```

### 3.0 Duty Cycle Limits

Typically, Avtech pulse generators are limited to a maximum duty cycle because of thermal constraints, where duty cycle is the ratio of Pulse Width to the reciprocal of the Repetition Rate (i.e.; R times W). Although the generator contains automatic protection against an excessive duty cycle, whenever this protection is activated, the output is inhibited. Therefore, it may be desirable to have the control computer calculate the duty ratio, then generate a warning message to the operator whenever the limits are exceeded (preferably prior to actually sending the command sequence).

This message could caution the user either to reduce the repetition rate or the pulse width, to avoid thermal overload.

While this calculation is not mandatory, it could avoid the annoyance of automatic inhibiting of the generator output.

## OP-1 Operating Instructions

### 4.0 Changing the Unit GPIB Address

Since the GPIB data bus address for the pulse generator has been preset to "8" in the factory, commands are required to be sent to this address. However, the user may wish to change the address to any address in the allowed range of 0 to 30. This address may be easily changed by re-setting the GPIB address switch on the GPIB Interface board located inside the pulse generator chassis.

The address is set by means of a five position "Dipswitch " located on the top of a small circuit card located inside the enclosure near the top rear. The switch may be observed to be set to the default address by noting that the Dipswitch position 4 is set in the OFF position, defining a binary address of 8.

The switch setting is calculated as the sum of the switch weights in the OFF position, calculated as follows: (a switch in the ON position it has a weight of zero):

Switch Number	OFF Weight
1	1
2	2
3	4
4	8
5	16

For example, a switch with positions 1, 4 and 5 set to OFF will result in an address setting of 25 (16 plus 8 plus 1 = 25).

### 5.0 Trouble-Shooting Aid

In the event that difficulties are encountered communicating via the GPIB interface, two auxiliary communications status indicators have been included on the GPIB interface circuit card. These status indicators are small LED lamps, one which flashes briefly whenever a properly addressed command is received. The second LED will light whenever an out-of-range value or invalid command is received, and will remain lit until a valid command with a valid in-range value is subsequently received.

May 2/97

edition A

-R5

Disk: AVR-5

Name: BCPNOPIA.INS