



AVTECH ELECTROSYSTEMS LTD.
NANOSECOND WAVEFORM ELECTRONICS

□ P.O. BOX 265
OGDENSBURG, NY
U.S.A. 13669-0265
TEL: (315) 472-5270
FAX: (613) 226-2802

☒ BOX 5120 STN. F
OTTAWA, ONTARIO
CANADA K2C 3H4
TEL: (613) 226-5772
FAX: (613) 226-2802

INSTRUCTIONS

MODEL AVR-7B-C-PN PULSE GENERATOR

S.N. :

WARRANTY

Avtech Electrosystems Ltd. warrants products of its manufacture to be free from defects in material and workmanship under conditions of normal use. If, within one year after delivery to the original owner, and after prepaid return by the original owner, this Avtech product is found to be defective, Avtech shall at its option repair or replace said defective item. This warranty does not apply to units which have been disassembled, modified or subjected to conditions exceeding the applicable specifications or ratings. This warranty is the extent of the obligation or liability assumed by Avtech with respect to this product and no other warranty or guarantee is either expressed or implied.

Fig. 1

PULSE GENERATOR TEST ARRANGEMENT

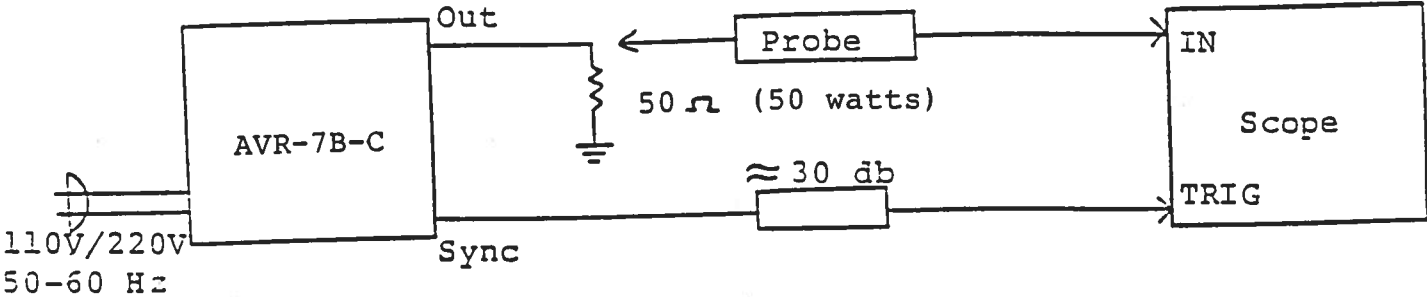

Notes:

- 1) The bandwidth capability of components and instruments used to display the pulse generator output signal (attenuators, cables, connectors, etc.) should exceed 100 MHz.
- 2) The SYNC output channel provides TTL level signals. To avoid overdriving the TRIG input channel of some scopes, a 30 db attenuator should be placed at the input to the scope trigger channel. The SYNC output precedes the main output when the front panel LEAD-LAG switch is in the LEAD position. The SYNC output lags the main output when the switch is in the LAG position.

The DELAY control controls the relative delay between the reference output pulse provided at the SYNC output and the main output. This delay is variable over the range of 0.1 us to 100 us.

	MIN	MAX
Range 1	0.1 us	1.0 us
Range 2	1.0 us	10 us
Range 3	10 us	100 us

- 3) The output pulse width is controlled by means of the front panel one turn PW control and by the PW RANGE control (units with -PWT option have a ten turn PW control). The minimum and maximum PW for each range and the corresponding maximum PRF are as follows. Note that the unit may fail if operated at duty cycles exceeding the above.

	PW min	PW max
Range 1	0.1 us PRF max 10 kHz	1.0 us PRF max 5 kHz
Range 2	1.0 us PRF max 5 kHz	10 us PRF max 500 Hz
Range 3	10 us PRF max 500 Hz	100 us PRF max 50 Hz

To voltage control the output pulse width within each range, set the rear panel switch in the EXT position and apply 0 to +10 volts between terminal A and ground ($R_{IN} > 10K$). (option).

- 4) To obtain a stable output display the PRF control on the front panel should be set mid range. The front panel TRIG toggle switch should be in the INT position. The DELAY controls and the scope triggering controls are then adjusted to obtain a stable output. The scope may then be used to set the desired PRF by rotating the PRF and PRF FINE controls.
- 5) The output pulse amplitude is controlled by means of the front panel ten turn AMP control. To voltage control the output amplitude, set the rear panel switch in the EXT position and apply 0 to +10 volts between terminal A and ground ($R_{IN} > 10K$). (-EA option).
- 5A) EAD option: To digitally control the output amplitude (in 256 increments) set the rear panel switch in the EXT position and apply a parallel TTL control to PINS 1 to 8 (PIN 1 = LSB, PIN 8 = MSB) to the rear panel D connector (PIN 14 ground).
- 6) The output polarity is controlled by the two position polarity switch. CAUTION: To avoid stressing of the output stage it is recommended that the amplitude be reduced to near zero before changing the output polarity.
- 7) An external clock may be used to control the output PRF of the AVR unit by setting the front panel TRIG toggle switch in the EXT position and applying a 0.2 us (approx.) TTL level pulse to the SYNC BNC connector input. For operation in this mode, the scope time base must also be triggered by the external clock rather than from the SYNC output.
- 8) For single pulse manual operation, set the front panel INT-EXT-MAN switch in the MAN position and push the SINGLE PULSE button.
- 9) The AVR-7B-C features an output impedance of the order of several ohms (rather than 50 ohms). The following consequences of this feature should be noted:
 - a) When used to switch some semiconductor devices (eg. bipolar and VMOS power transistors), the AVR unit will yield much faster switching times than those provided by 50 ohm pulse generators.
 - b) The AVR unit will safely operate in to load impedances in the range of 50 ohms to an open circuit. However, the fall time may degrade for load impedances higher than fifty ohms.

- c) The AVR unit may be effectively converted to a fifty ohm output impedance generator by placing a fifty ohm carbon composition resistor in series with the output of the unit and the load. The maximum available load voltage will then decrease to 350 volts (from 700 volts).
 - d) The output switching elements may fail if the unit is inadvertently operated into a short circuit. The switching elements are easily replaced in the field following the procedure outlined in the REPAIR Section.
- 10) CAUTION: The output stage is protected against overload condition by a 2.0 A slow blow fuse on the main frame back panel. However, the output switching elements may fail if the unit is triggered at a PRF exceeding 1 KHz or at duty cycles resulting in an average output power in excess of 50 watts. Heating and subsequent likely failure of the output stage is reduced if the following action is taken where possible:
- a) PRF is kept to a minimum, i.e. operate in a low PRF range when possible rather than in a high PRF range.
 - b) Keep the output PW to a minimum.
- 11) OVERLOAD INDICATOR. AVR-7-C units with a serial number higher than 5600 are protected by an automatic overload protective circuit which controls the front panel overload light. If the unit is overloaded (by operating at an exceedingly high duty cycle or by operating into a short circuit), the protective circuit will turn the output of the instrument OFF and turn the indicator light ON. The light will stay ON (i.e. output OFF) for about 5 seconds after which the instrument will attempt to turn ON (i.e. light OFF) for about 1 second. If the overload condition persists, the instrument will turn OFF again (i.e. light ON) for another 5 seconds. If the overload condition has been removed, the instrument will turn on and resume normal operation. Overload conditions may be removed by:
- 1) Reducing PRF (i.e. switch to a lower range)
 - 2) Reducing pulse width (i.e. switch to a lower range)
 - 3) Removing output load short circuit (if any)
- 12) The unit can be converted from 110 to 220V 50-60 Hz operation by adjusting the voltage selector card in the rear panel fused voltage selector cable connector assembly.
- 13) For further assistance:

Tel: 613-226-5772

Fax: 613-226-2802

Fig. 2

FRONT PANEL CONTROLS

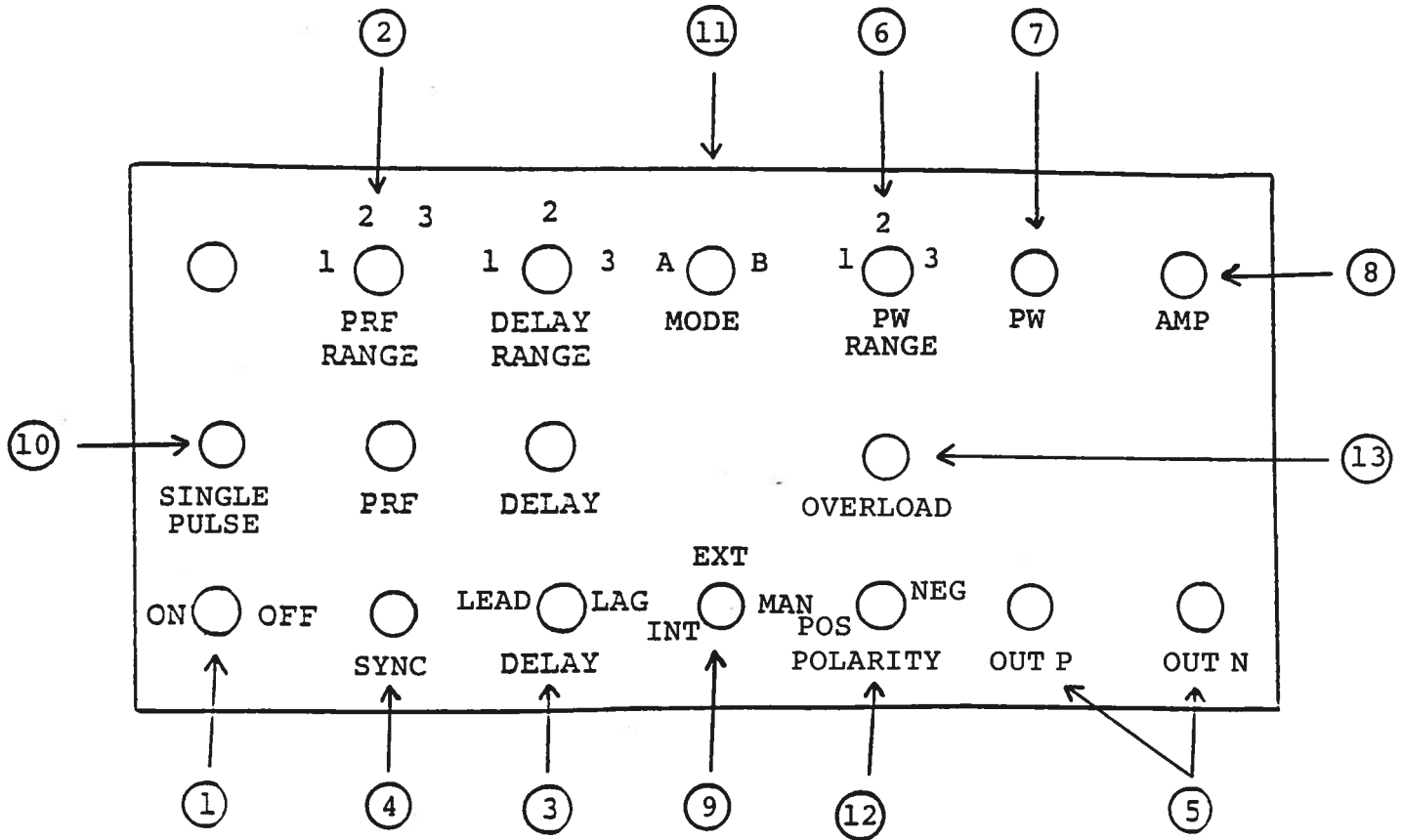

- (1) ON-OFF Switch. Applies basic prime power to all stages.
- (2) PRF Control. Varies PRF from 0.1 Hz to 10 kHz as follows:

Range 1	5 Hz	50 Hz
Range 2	20 Hz	200 Hz
Range 3	100 Hz	1 kHz
Range 4	1 kHz	10 kHz

- (3) DELAY Control. Controls the relative delay between the reference output pulse provided at the SYNC output (4) the main output (5). This delay is variable over the range of 0.1 to about 100 us. Delay LEADS or LAGS depending on the position of the LEAD-LAG switch.

	MIN	MAX
Range 1	0.1 us	1.0 us
Range 2	1.0 us	10 us
Range 3	10 us	100 us

- (4) SYNC Output. This output is used to trigger the scope time base. The output is a TTL level 100 ns (approx.) pulse capable of driving a fifty ohm load. This output precedes the output at (5) if the two position LEAD-LAG switch is in the LEAD position. This output follows the output at (5) if the switch is in the LAG position. The delay range is variable from 0.1 usec to 100 usec. The external trigger signal is applied at this input when the EXT-INT toggle switch is in the EXT position.
- (5) OUT Connectors. N connectors provide output to a 50 ohm load.
- (6) PW Control. A one turn control (ten turn control for units with the -PWT option) and 3 position range switch which varies the positive output pulse width from 0.1 us to 100 us. The minimum and maximum PW for each range and the corresponding maximum PRF are as follows. Note that the unit may fail if operated at duty cycles exceeding the above.

	PW min	PW max
Range 1	0.1 us PRF max 10 kHz	1.0 us PRF max 5 kHz
Range 2	1.0 us PRF max 5 kHz	10 us PRF max 500 Hz
Range 3	10 us PRF max 500 Hz	100 us PRF max 50 Hz

- (8) AMP Control. A ten turn control which varies the output pulse amplitude from 0 to 700 V.
- (9) EXT-INT-MAN Control. With this toggle switch in the INT position, the PRF of the AVR unit is controlled via an internal clock which in turn is controlled by the PRF control. With the toggle switch in the EXT position, the AVR unit requires a 0.2 us TTL level pulse applied at the SYNC input in order to trigger the output stages. In addition, in this mode, the scope time base must be triggered by the external trigger source. With the MODE A-B switch in the A position the output pulse width is controlled by the PW controls. With the MODE A-B switch in the B position, the output pulse width equals the input trigger pulse width. For single pulse operation, set the INT-EXT-MAN switch in the MAN position.
- (10) SINGLE PULSE. For single pulse manual operation, set the front panel INT-EXT-MAN switch in the MAN position and push the SINGLE PULSE button.
- (11) MODE A-B. For output pulse width control via the PW controls, the MODE switch should be in the A position. When triggering via an externally applied TTL level trigger pulse, the output pulse width equals the input trigger pulse width if the MODE switch is in the B position.
- (12) POLARITY. The output pulse polarity is controlled by this two position switch. CAUTION: To avoid stressing the output stage, it is recommended that the output amplitude be reduced to near zero before changing the output polarity.
- (13) OVERLOAD INDICATOR. AVR-7-C units with a serial number higher than 5600 are protected by an automatic overload protective circuit which controls the front panel overload light. If the unit is overloaded (by operating at an exceedingly high duty cycle or by operating into a short circuit), the protective circuit will turn the output of the instrument OFF and turn the indicator light ON. The light will stay ON (i.e. output OFF) for about 5 seconds after which the instrument will attempt to turn ON (i.e. light OFF) for about 1 second. If the overload condition persists, the instrument will turn OFF again (i.e. light ON) for another 5 seconds. If the overload condition has been removed, the instrument will turn on and resume normal operation. Overload conditions may be removed by:
- 1) Reducing PRF (i.e. switch to a lower range)
 - 2) Reducing pulse width (i.e. switch to a lower range)
 - 3) Removing output load short circuit (if any)

Fig. 3

BACK PANEL CONTROLS (EA, EW OPTION UNITS)

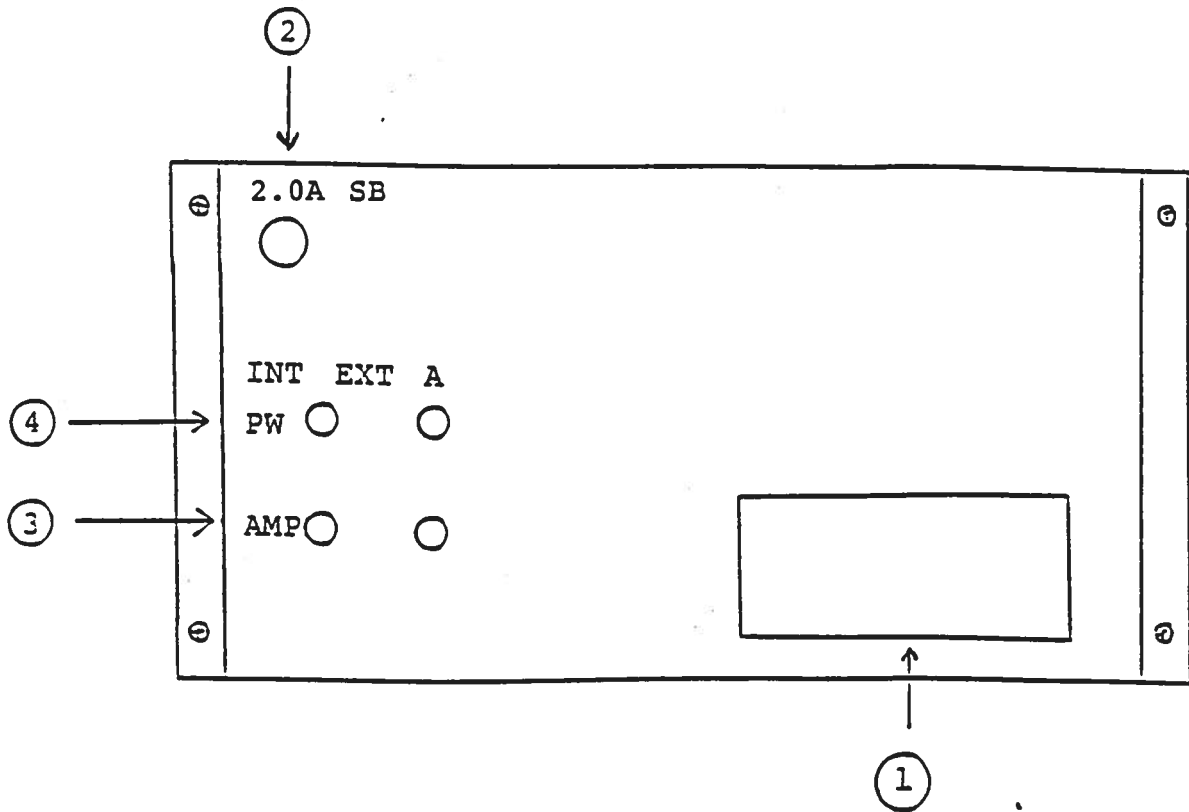

- (1) FUSED CONNECTOR, VOLTAGE SELECTOR. The detachable power cord is connected at this point. In addition, the removable cord is adjusted to select the desired input operating voltage. The unit also contains the main power fuse (1.0 A SB).
- (2) 2.0A SB. Fuse which protects the output stage if the output duty cycle rating is exceeded.
- (3) EA. To voltage control the output amplitude, set the switch in the EXT position and apply 0 to +10 volts between terminal A and ground ($R_{IN} > 10K$). (option).
- (4) EW. To voltage control the output pulse width, set the switch in the EXT position and apply 0 to +10 volts between terminal A and ground ($R_{IN} > 10K$). (option).

Fig. 3

BACK PANEL CONTROLS (EAD, EW OPTION UNITS)

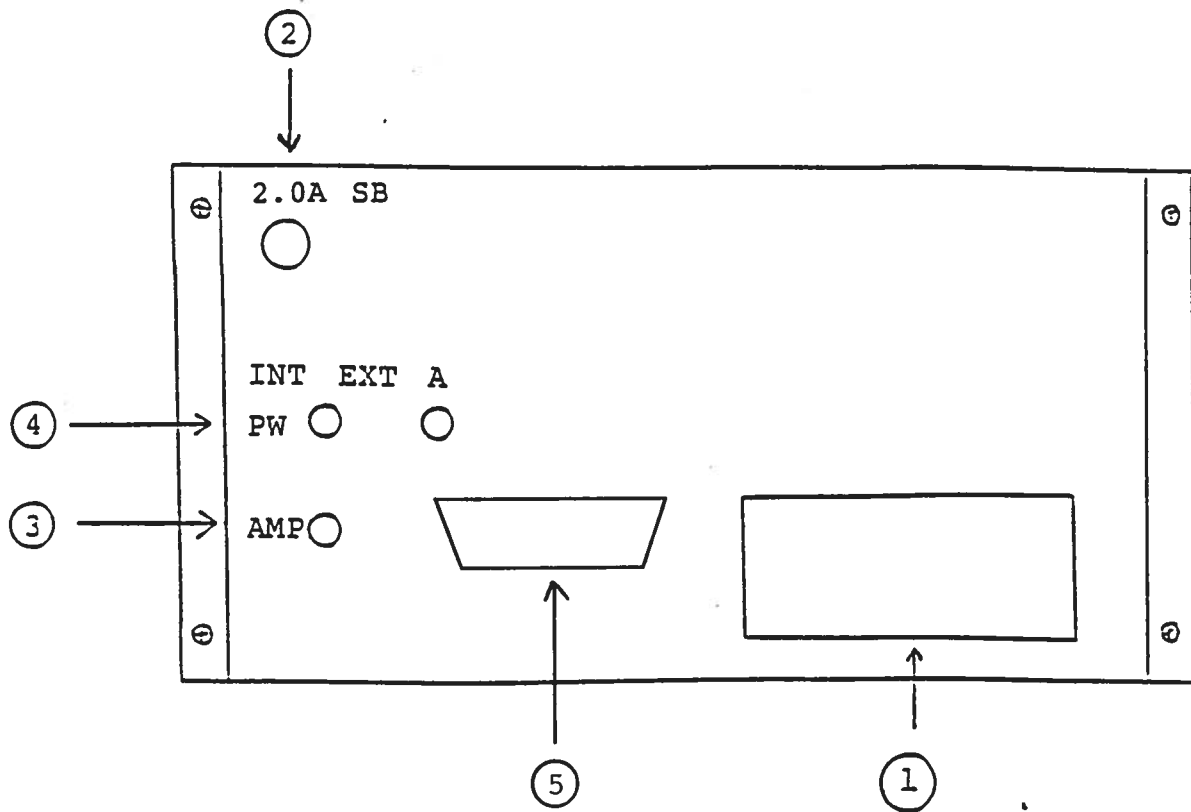

- (1) FUSED CONNECTOR, VOLTAGE SELECTOR. The detachable power cord is connected at this point. In addition, the removable cord is adjusted to select the desired input operating voltage. The unit also contains the main power fuse (1.0 A SB).
- (2) 2.0A SB. Fuse which protects the output stage if the output duty cycle rating is exceeded.
- (3) EAD option. To digitally control the output amplitude (in 256 increments) set the switch (3) in the EXT position and apply a parallel TTL control to PINS 1 to 8 (PIN 1 = LSB, PIN 8 = MSB) to the D connector (5). PIN 14 is ground.

Logic Level	Volts	Current
0	0 to +0.8V	10 uA (max)
1	+2 to +5V	10 uA (max)

- (4) EW. To voltage control the output pulse width, set the switch in the EXT position and apply 0 to +10 volts between terminal A and ground ($R_{IN} > 10K$). (option).
- (5) EAD D Connector. 14 PIN amphenol panel receptacle No. 57-60140. Mates with 57-50140.

POWER SUPPLY

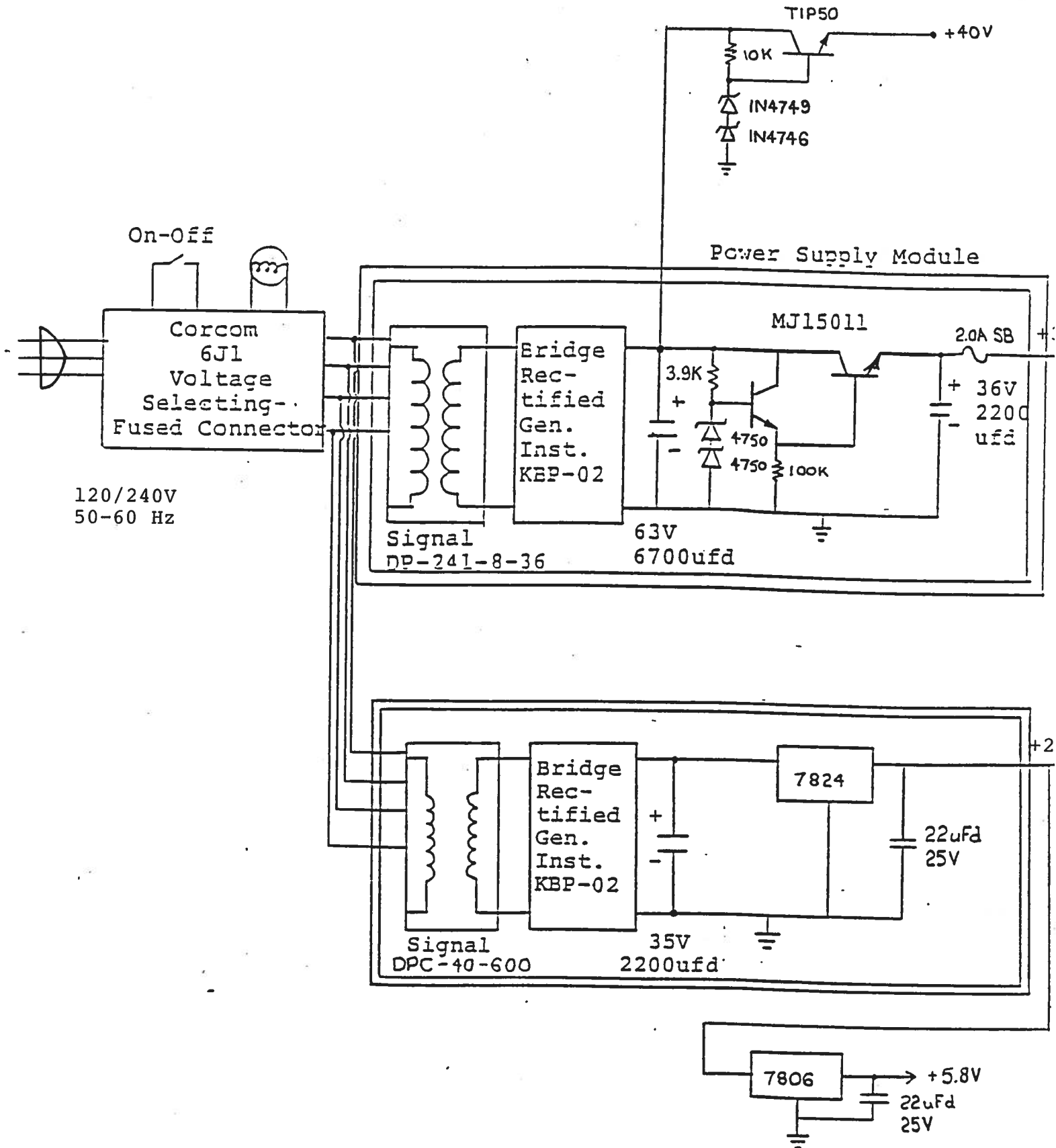

AVR-7B-C-PN

MODE

A B

+5.8V

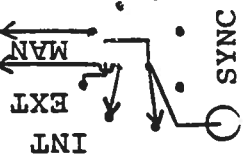
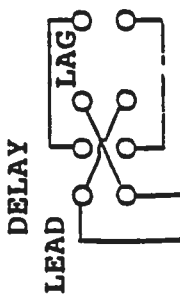
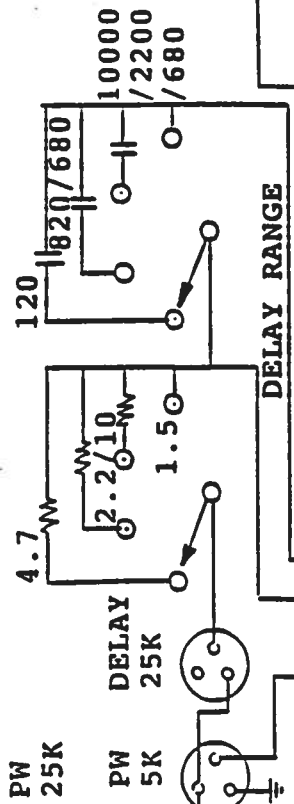
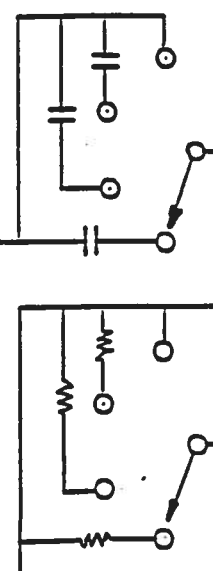
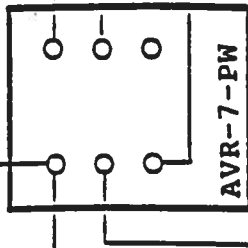

Single pulse

A B

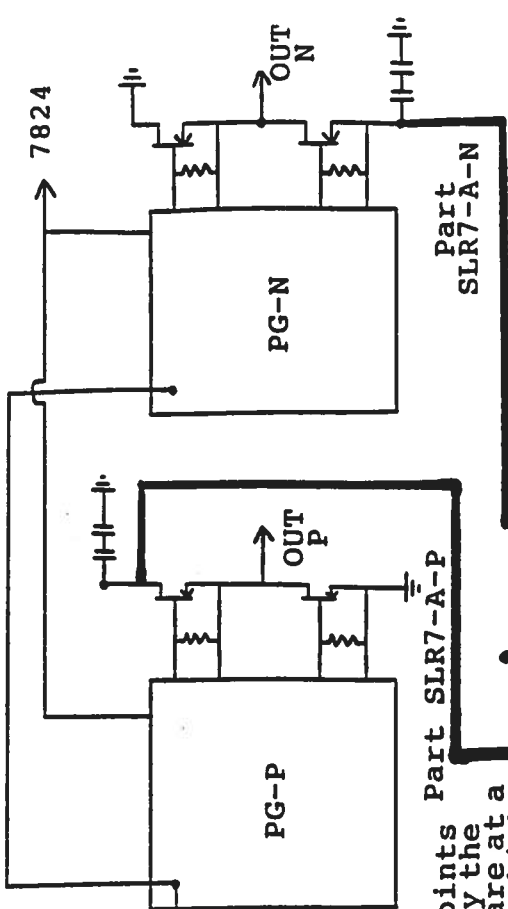
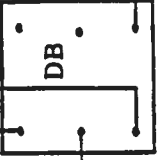

CAUTION: Points connected by the bold lines are at a potential as high as 750 volts

Part SLR7-A-P Part SLR7-A-N

1000 / 2200 / 680



POLARITY

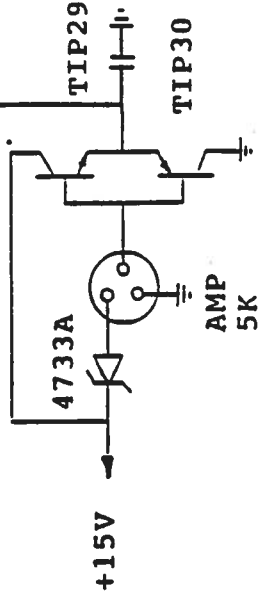

+15V

7824

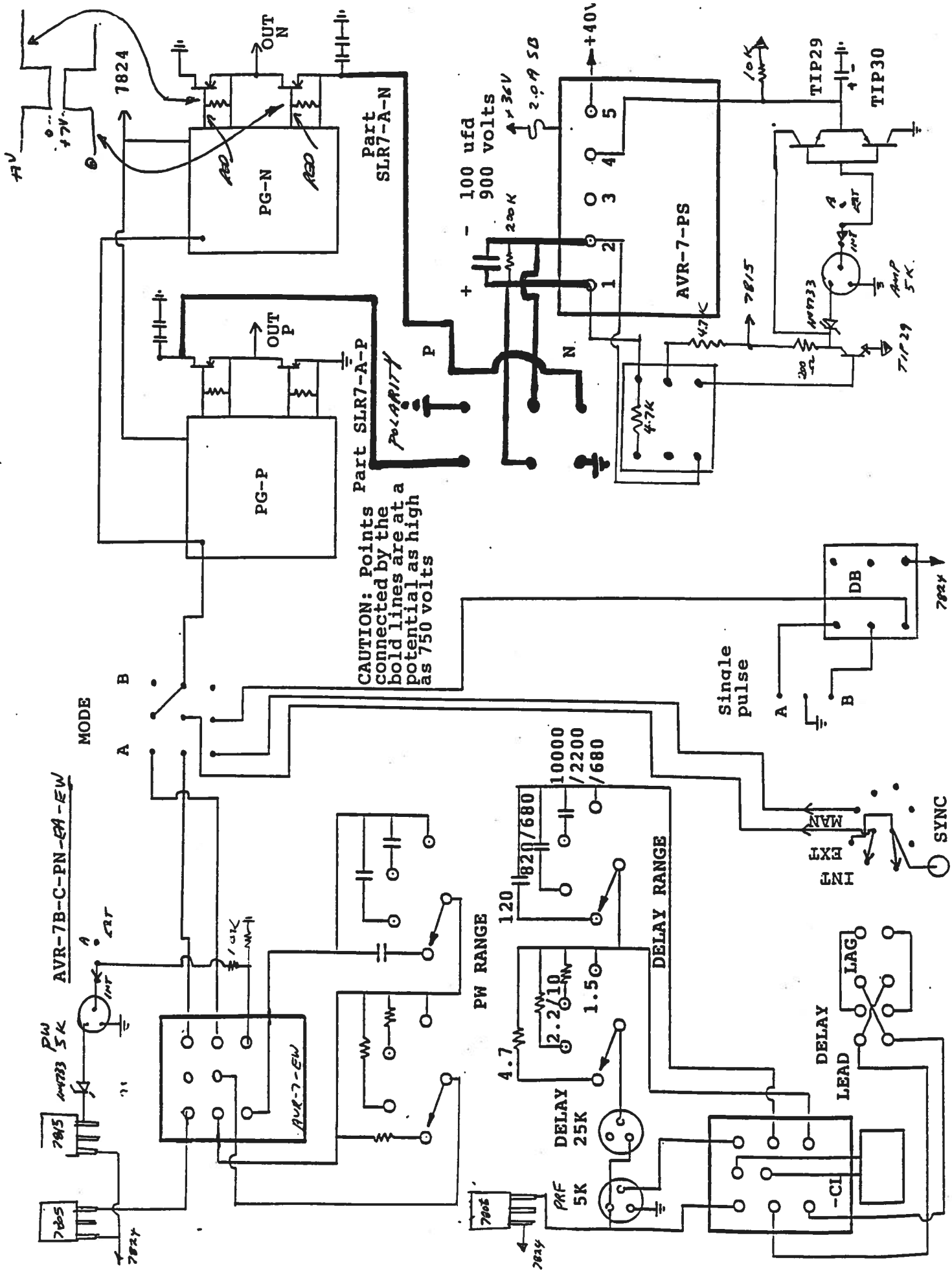

CAUTION: Points connected by the bold lines are at a potential as high as 750 volts

100 ufd
900 volts
2.0A 5B

PW RANGE

DELAY RANGE

Single pulse

MAN
EXE
EN

DELAY
LEAD
LAG

-CL

7024

DB

7815

4.7K

200

AVR23

AMP

5K

7815

10K

TIP29

TIP30

7824

AVR-7-PS

1

2

3

4

5

+40V

PG-N

PG-P

OUT N

OUT P

Part SLR7-A-N

Part SLR7-A-P

POLARITY

7824

7005

7024

AVR-7-B-C-PN-CA-EW

MODE

A

B

7815

7824

7824

7824

7824

7824

7824

7824

7824

7824

7824

7824

7824

7824

7824

7824

7824

7824

7824

7824

7824

7824

SYSTEM DESCRIPTION AND REPAIR PROCEDURE

CAUTION: Potentials as high as 750 volts DC are employed in the interior of this instrument so extreme caution must be exercised when attempting repairs. The following parts may be at high potential:

- a) Part No. SLR7-A-P and Part No. SLR7-A-N (and associated leads and capacitors).
- b) Pins 1 and 2 on module AVR-7B-PS (and associated leads and capacitors).

The AVR-7B-P-C consists of the following basic modules:

- 1) AVR-7B-PG pulse generator modules (P and N)
- 2) AVR-7B-PS power supply module
- 3) AVR-7B-PW pulse width module
- 4) AVR-7B-CL clock module
- 5) +36, +40, +24 volt power supplies

The modules are interconnected as shown in Fig. 4.

In the event of an instrument malfunction, it is most likely that the 2.0 A slow blow fuse or the main power fuse on the rear panel has blown. Replace if necessary. If the unit still does not function, it is most likely that some of the output switching elements (IRFAG50) may have failed due to an output short circuit condition or to a high duty cycle condition. The switching elements may be accessed by removing the top cover plate. The cover plate is removed by removing the 4 Phillips screws on the back panel. **NOTE:** First turn off the prime power. **CAUTION:** Thoroughly ground the IRFAG50 cases to discharge the 750 volts power supply potential. The IRFAG50 may be removed from the mounting bracket and checked on a curve tracer and replaced if necessary. AVTECH Part No. SLR7-A consists of the two transistors mounted on the bracket with insulating washers, 1 K resistors and output cable.

Schroff 06.24.92 Edition C

- PWT

- EW

- EA

- EAD

- AT