



AVTECH ELECTROSYSTEMS LTD.

NANOSECOND WAVEFORM ELECTRONICS
SINCE 1975

P.O. BOX 265
OGDENSBURG, NY
U.S.A. 13669-0265
TEL: (315) 472-5270
FAX: (613) 226-2802

TEL: 1-800-265-6681
FAX: 1-800-561-1970
U.S.A. & CANADA

e-mail: info@avtechpulse.com

BOX 5120 STN. F
OTTAWA, ONTARIO
CANADA K2C 3H4
TEL: (613) 226-5772
FAX: (613) 226-2802

INSTRUCTIONS

MODEL AVR-B3-C-PN-HS1 PULSE GENERATOR

S.N. :

WARRANTY

Avtech Electrosystems Ltd. warrants products of its manufacture to be free from defects in material and workmanship under conditions of normal use. If, within one year after delivery to the original owner, and after prepaid return by the original owner, this Avtech product is found to be defective, Avtech shall at its option repair or replace said defective item. This warranty does not apply to units which have been disassembled, modified or subjected to conditions exceeding the applicable specifications or ratings. This warranty is the extent of the obligation or liability assumed by Avtech with respect to this product and no other warranty or guarantee is either expressed or implied.

Fig. 1

PULSE GENERATOR TEST ARRANGEMENT

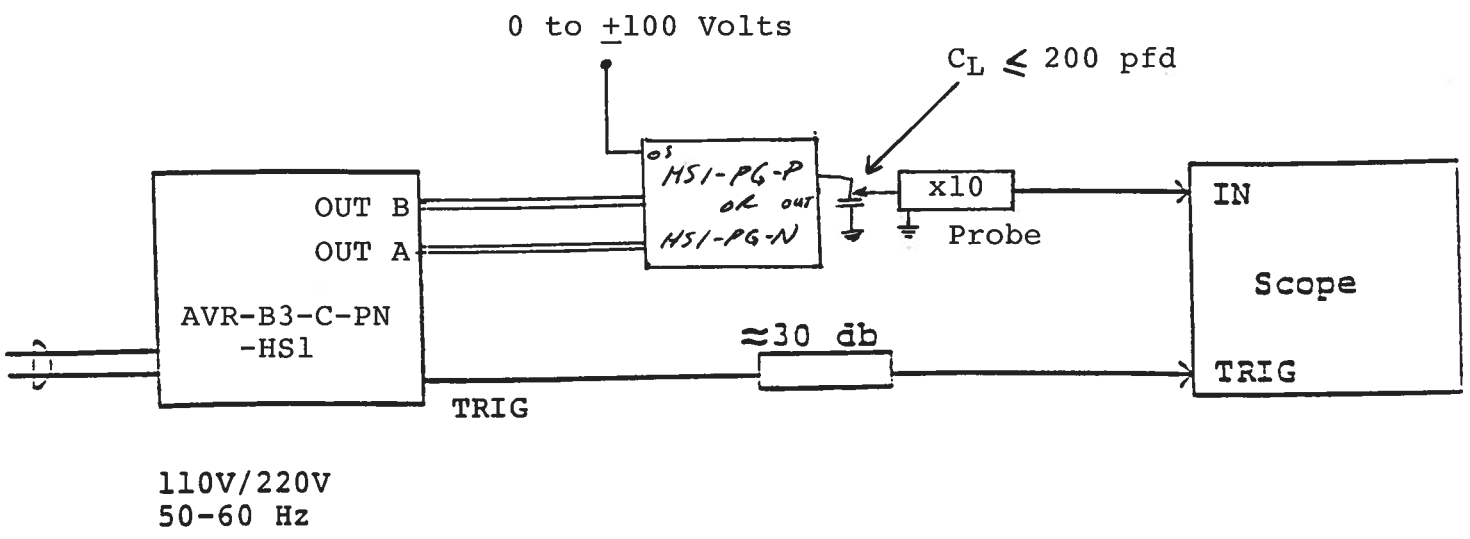

Notes:

- 1) The general test arrangement is shown in Fig. 1. The output pulse polarity is controlled by the -PG module. For example, for a positive output, install the -PG-P module and for a negative output install the -PG-N module. Note that the 50 Ohm cable and the multi-pin cable must be connected to the OUT A and OUT B connectors, respectively, on the mainframe front panel.
- 2) CAUTION: The capacitive load must not exceed 200 pfd and the length of line between the capacitive load and the -PG OUT SMA connector must not exceed one inch (particularly at high PRF such as 1.0 MHz). Note also that the unit may be damaged if the duty cycle exceeds 10% (eg. 100 ns at 1.0 MHz) for a capacitive load. In general, the unit should be operated at the lowest possible PRF so as to reduce the heating of the output modules. The unit will also drive a 50 Ohm resistor load but in such cases, the output PRF must not exceed 20 kHz.
- 3) To apply a DC offset to the capacitive load, connect the required DC potential (0 to $\pm 100V$) to the solder terminal on the back of the -PG module.
- 4) The bandwidth capability of components and instruments used to display the pulse generator output signal (attenuators, cables, connectors, etc.) should exceed 200 MHz.
- 5) The TRIG output channel provides TTL level signals. To avoid overdriving the TRIG input channel of some scopes, a 30 dB attenuator should be placed at the input to the scope trigger channel. The TRIG output precedes the main output when the front panel ADVANCE-DELAY switch is in the ADVANCE position. The TRIG output lags the main output when the switch is in the DELAY position.
- 6) To obtain a stable output display the PW and PRF controls on the front panel should be set mid range. The front panel TRIG toggle switch should be in the INT position. The DELAY controls and the scope triggering controls are then adjusted to obtain a stable output. The scope may then be used to set the desired PRF by rotating the PRF controls.
- 7) The output pulse width is controlled by means of the front panel one turn PW control. To voltage control the pulse width, set the rear panel switch in the EXT position and apply 0 to +10 Volts between terminal A and ground ($R_{IN} \geq 10K$). (option).

- 8) The output pulse amplitude is controlled by means of the front panel one turn AMP control. To voltage control the output, set the rear panel switch in the EXT position and apply 0 to +10 Volts between terminal A and ground ($R_{IN} \geq 10K$). (option).
- 9) An external clock may be used to control the output PRF of the AVR unit by setting the front panel TRIG toggle switch in the EXT position and applying a 0.2 us (approx.) TTL level pulse to the TRIG BNC connector input. For operation in this mode, the scope time base must also be triggered by the external clock rather than from the SYNC output.
- 10) AVR units with a serial number higher than 5600 are protected by an automatic overload protective circuit which controls the front panel overload light. If the unit is overloaded (by operating at an exceedingly high duty cycle or by operating into a short circuit), the protective circuit will turn the output of the instrument OFF and turn the indicator light ON. The light will stay ON (i.e. output OFF) for about 5 seconds after which the instrument will attempt to turn ON (i.e. light OFF) for about 1 second. If the overload condition persists, the instrument will turn OFF again (i.e. light ON) for another 5 seconds. If the overload condition has been removed, the instrument will turn on and resume normal operation. Overload conditions may be removed by:
 - 1) Reducing PRF (i.e. switch to a lower range)
 - 2) Reducing pulse width (i.e. switch to a lower range)
 - 3) Removing output load short circuit (if any)
- 11) The unit can be converted from 110 to 220V 50-60 Hz operation by adjusting the voltage selector card in the rear panel fused voltage selector-cable connector assembly.
- 12) For additional assistance:

Tel: (613) 226-5772
Fax: (613) 226-2802

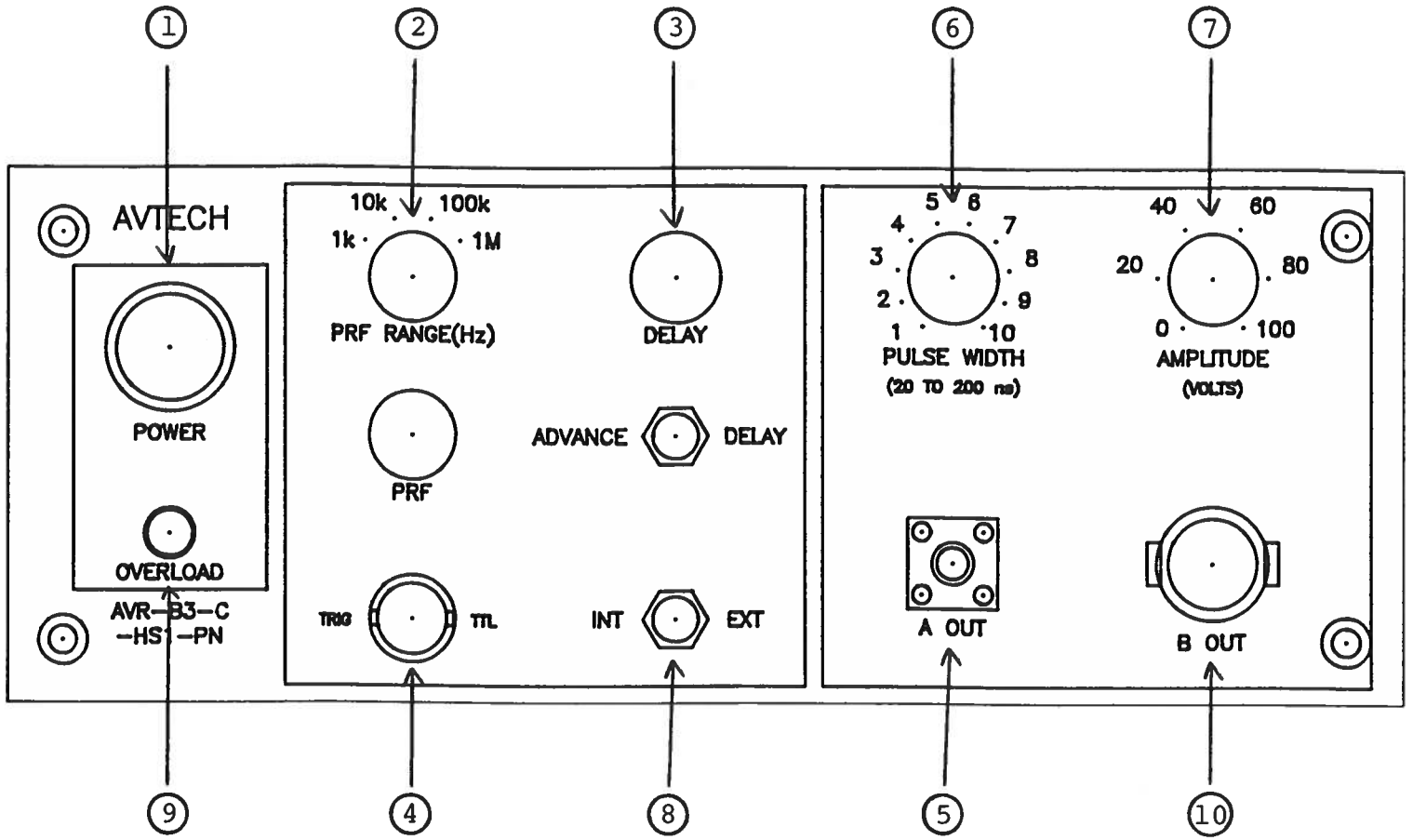

Fig. 2

FRONT PANEL CONTROLS

- (1) ON-OFF Switch. Applies basic prime power to all stages.
- (2) PRF Control. Varies PRF as follows:

	MIN	MAX
Range 1	100 Hz	1 kHz
Range 2	1 kHz	10 kHz
Range 3	10 kHz	100 kHz
Range 4	100 kHz	1 MHz

The operating PRF should be set using a scope.

- (3) DELAY Control. Controls the relative delay between the reference output pulse provided at the TRIG output (4) and the -PG output. This delay is variable over the range of 0 to about 200 ns. The TRIG output precedes the main output when the ADVANCE-DELAY switch is in the ADVANCE position and lags when the switch is in the DELAY position.
- (4) TRIG Output. This output is used to trigger the scope time base. The output is a TTL level 100 ns (approx.) pulse capable of driving a fifty Ohm load.
- (5) OUT A Connector. SMA connector provides output to the 50 Ohm cable to the -PG module.
- (6) PW Control. A one turn control which varies the output pulse width from 20 ns to 200 ns.
- (7) AMP Control. A one turn control which varies the output pulse amplitude to a fifty Ohm load.
- (8) EXT-INT Control. With this toggle switch in the INT position, the PRF of the AVR unit is controlled via an internal clock which in turn is controlled by the PRF controls. With the toggle switch in the EXT position, the AVR unit requires a 0.2 us TTL level pulse applied at the TRIG input in order to trigger the output stages. In addition, in this mode, the scope time base must be triggered by the external trigger source.

- (9) OVERLOAD. AVR units with a serial number higher than 5600 are protected by an automatic overload protective circuit which controls the front panel overload light. If the unit is overloaded (by operating at an exceedingly high duty cycle or by operating into a short circuit), the protective circuit will turn the output of the instrument OFF and turn the indicator light ON. The light will stay ON (i.e. output OFF) for about 5 seconds after which the instrument will attempt to turn ON (i.e. light OFF) for about 1 second. If the overload condition persists, the instrument will turn OFF again (i.e. light ON) for another 5 seconds. If the overload condition has been removed, the instrument will turn on and resume normal operation. Overload conditions may be removed by:
- 1) Reducing PRF (i.e. switch to a lower range)
 - 2) Reducing pulse width (i.e. switch to a lower range)
 - 3) Removing output load short circuit (if any)
- (10) OUT B. Multi-pin connector connects to multi-wire cable to -PG module.

Fig. 3

BACK PANEL CONTROLS

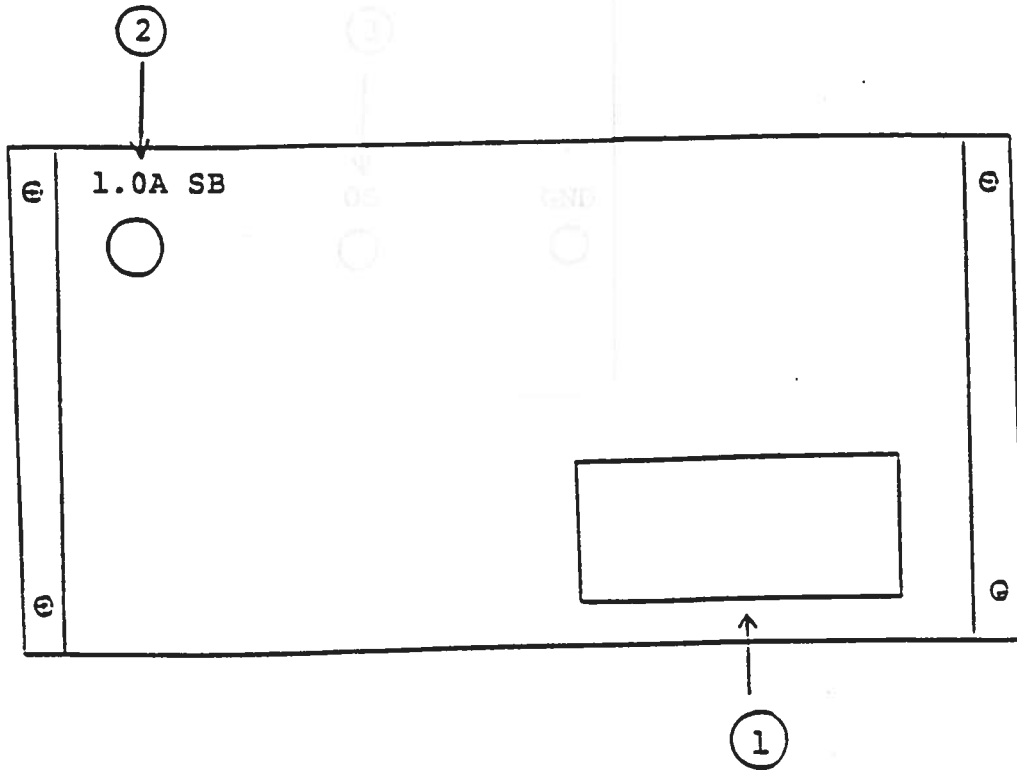

- (1) FUSED CONNECTOR, VOLTAGE SELECTOR. The detachable power cord is connected at this point. In addition, the removable cord is adjusted to select the desired input operating voltage. The unit also contains the main power fuse (0.5A SB).
- (2) 1.0A SB. Fuse which protects the output stage if the output duty cycle rating is exceeded.

TOP COVER REMOVAL

The top cover may be removed by removing the 4 Phillips screws on the top of the instrument. The top cover may then be slid back and off.

Fig. 4

SYSTEM BLOCK DIAGRAM

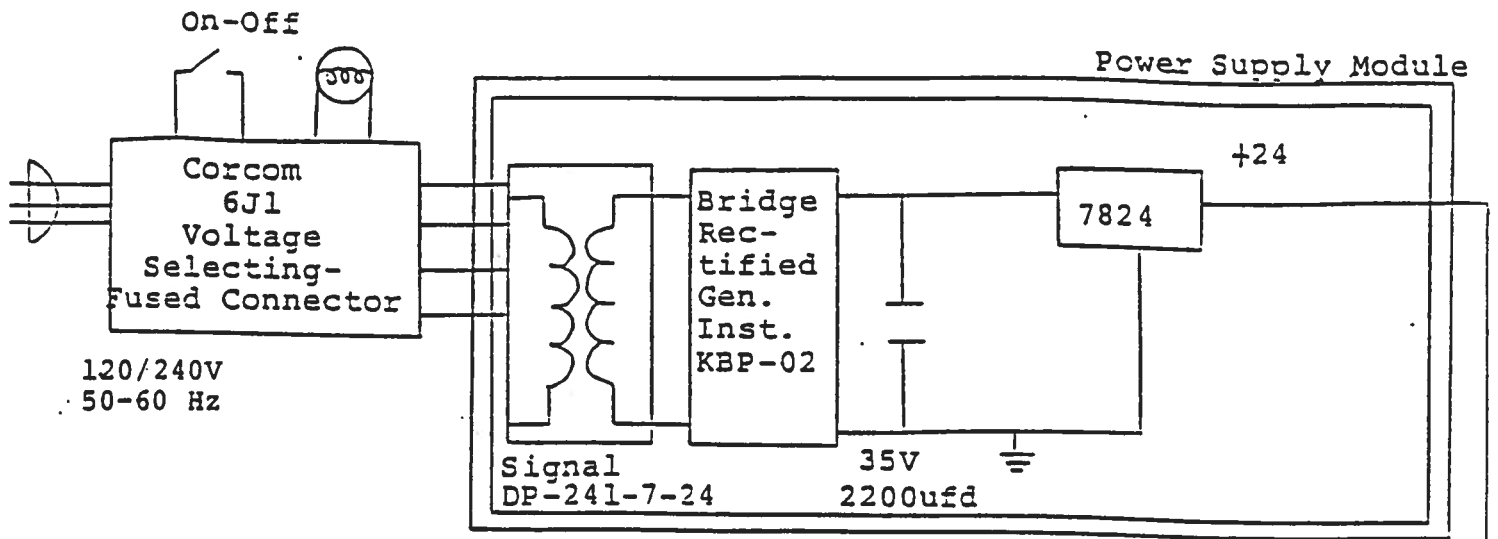

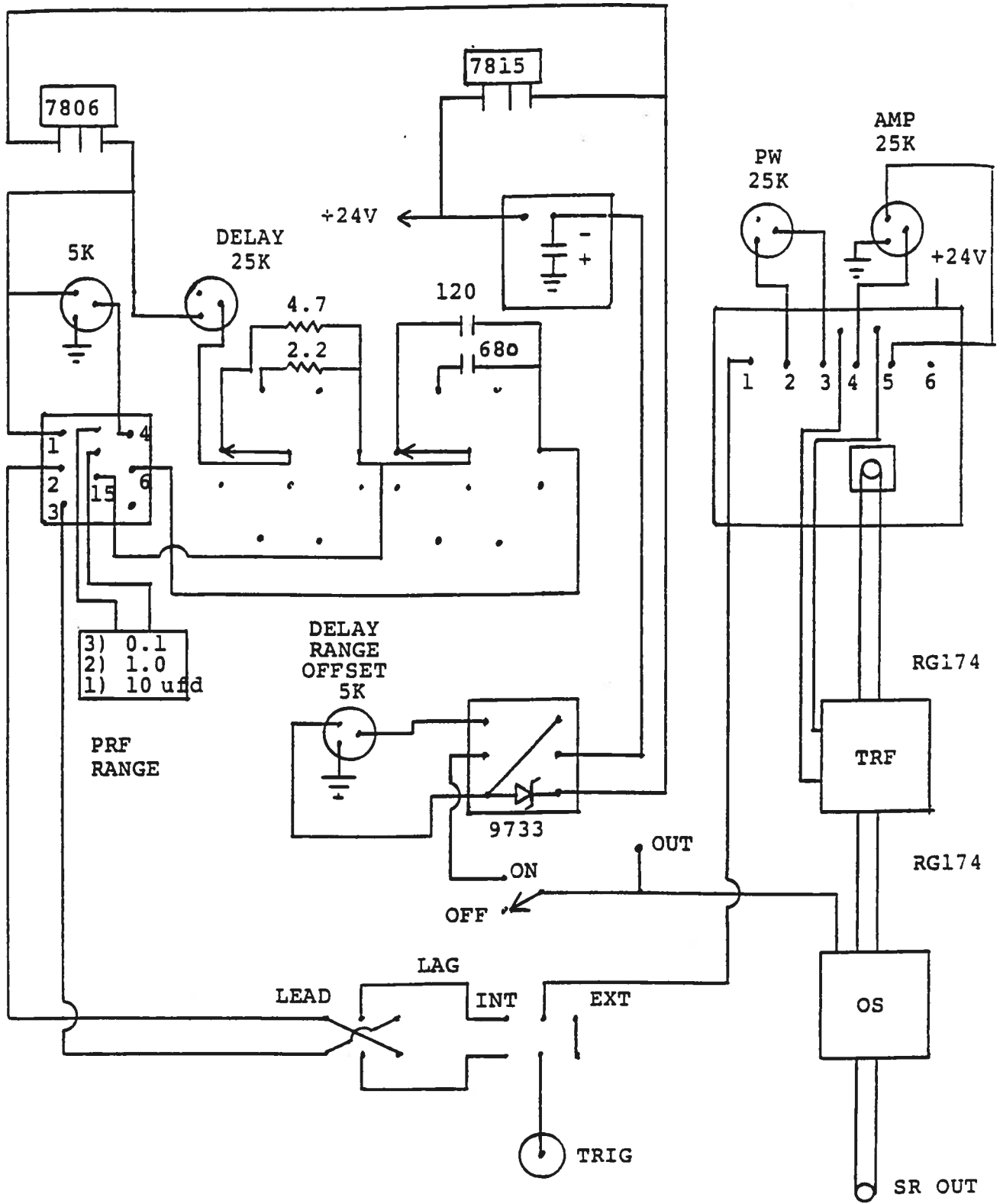

Fig. 5

AVR-EI-W-C-P-OT (GGB MOD)

SYSTEM DESCRIPTION AND REPAIR PROCEDURE

The AVR-B3-C-PN-HS1 unit consists of the following basic modules:

- 1) HS1-PG pulse generator modules (two)
- 2) -CL clock module
- 3) +24V power supply board
- 4) -OL overload module

The modules are interconnected as shown in Fig. 4.

In the event of an instrument malfunction, it is most likely that the 1.0 A slow blow fuse or the main power fuse on the rear panel has blown. Replace if necessary. If the unit still does not function, it is most likely that some of the output switching elements (SL5T) may have failed due to an output short circuit condition or to a high duty cycle condition. The switching elements may be accessed by removing the cover plate on the bottom side of the -PG module. The cover plate is removed by removing the four counter sunk 6-32 Phillips screws. NOTE: First turn off the prime power. CAUTION: Briefly ground the SL5T tabs to discharge the 100 Volts power supply potential. The elements may be removed from their sockets by means of a needle nosed pliers after removing the four counter sunk 2-56 Phillips screws which attach the small copper heat sinks to the body of the -PG module. The SL5T is a selected VMOS power transistor in a TO 220 package and may be checked on a curve tracer. If defective, replacement units should be ordered directly from Avtech. When replacing the SL5T switching elements, take care to insure that the short lead (of the three leads) is adjacent to the back of the chassis. (See following Fig.). The SL5T elements are electrically isolated from the small copper heat sinks but are bonded to the heat sinks using WAKEFIELD TYPE 155 HEAT SINK ADHESIVE. If the switching elements are not defective, then the four Phillips screws on the top panel should be removed. The top cover may then be slid off and operation of the clock and power supply modules checked. The clock module is functioning properly if:

- a) 0.1 us TTL level outputs are observed at pins 2 and 3.
- b) The PRF of the outputs can be varied over the range of 0.5 Hz to 5 kHz using the PRF controls.
- c) The relative delay between the pin 2 and 3 outputs can be varied by at least 1 us by the DELAY control.

The sealed clock module must be returned to Avtech for repair or replacement if the above conditions are not observed.



AVTECH ELECTROSYSTEMS LTD.

NANOSECOND WAVEFORM ELECTRONICS
SINCE 1975

P. O. BOX 265
OGDENSBURG, NY
U.S.A. 13669-0265
TEL: (315) 472-5270
FAX: (613) 226-2802

TEL: 1-800-265-6681
FAX: 1-800-561-1970
U.S.A. & CANADA

BOX 5120 STN. F
OTTAWA, ONTARIO
CANADA K2C 3H4
TEL: (613) 226-5772
FAX: (613) 226-2802

Fax Ref No: 10508 From: Avtech Electrosystems Ltd.
To: Harris Semiconductor, Our Fax No: (613) 226-2802
NC Date: January 23, 1995
Attn: Tom Jochum Receivers Fax No: 919-405-3651
Tel: 919-405-3623
Subject: Quotation No. of pages: 4

Following our telephone conversation of January 3rd, I am pleased to provide a price and delivery quotation for a special purpose pulse generator meeting the following specifications:

Model designation: AVR-B3-C-HS1.
For a positive output pulse add the suffix -P. For a negative output pulse add the suffix -N.

Output pulse amplitude: 0 to 100 Volts (one turn control).

Rise time: ≤ 5 ns.

Fall time: ≤ 10 ns.

Output pulse width: 20 ns to 200 ns (one turn control).

PRF: 100 Hz to 1.0 MHz.

Max. duty cycle: 10% (i.e. at 1.0 MHz, max pulse width is 100 ns).

Load: Designed specifically to drive a capacitive load of ≤ 200 pfd. Load must be connected to output SMA connector on output module using cable length of less than one inch. Unit will also drive a 50 Ohm load.

DC offset:

Required DC offset (0 to ± 100 Volts) is applied to a solder terminal on the output module.

Chassis format and size:

The instrument consists of a 3.9" x 8.5" x 14.8" mainframe and a 1.7" x 2.6" x 4.3" output module which connects to the mainframe via a 24" cable. The load is connected to the SMA output connector on the output module using a cable with a length of less than 1".

Other:

See standard AVR-B3-C, page 35, Cat. No. 9.

Price:

\$4,325.00 US each, FOB destination.

Delivery:

30-45 days.

Typical waveforms given by a prototype unit operating at ≈ 1.0 MHz are shown on the enclosed sheet. Note that the ringing and overshoot are a consequence of the unmatched load (200 pfd) and this cannot be avoided (except by replacing the 200 pfd by 50 Ohms).

Thank you for your interest in our products. Please call me again (1-800-265-6681) if you require any additional information or modifications to the above quotation.

Rgds

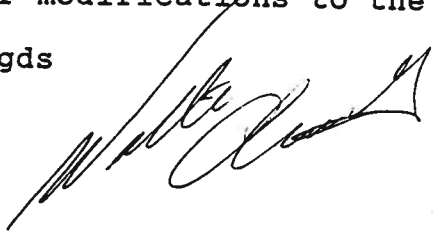
Dr. Walter Chudobiak
Chief Engineer

WC:pr

PULSE GENERATORS (AVR-B SERIES)

AVR-B1-C	\$2325.00
AVR-B1-PS	1777.00
AVR-B1	1226.00
AVR-B2-C	2605.00
AVR-B2-PS	2055.00
AVR-B2	1505.00
AVR-B3-C	2818.00
AVR-B3-PS	2269.00
AVR-B3	1719.00
-OP1 IEEE-488 GPIB option	1644.00
-OP2 IEEE-488.2 GPIB option	498.00
-OS Offset option	420.00
-EA Electronic Amp option***	350.00
-EAD 8 bit TTL control of Amp	450.00
-EW Electronic PW option***	350.00
-EWD 8 bit TTL control of PW	450.00
-PN Dual polarity option	700.00
-PN Dual polarity option (-W units)	1387.00
-PWT Ten turn PW control option	50.00
-AT Ten turn Amp control option	50.00
-T Variable rise, fall time option	560.00

*** For -PN-W option units
-EA and -EW options 700.00



AVTECH ELECTROSYSTEMS LTD.
 NANOSECOND WAVEFORM ELECTRONICS
 SINCE 1975

P.O. BOX 265
 OGDENSBURG, NY
 U.S.A. 13669-0265
 TEL: (315) 472-5270
 FAX: (613) 226-2802

TEL: 1-800-265-6681
 FAX: 1-800-561-1970
 U.S.A. & CANADA

☒ BOX 5120 STN. F
 OTTAWA, ONTARIO
 CANADA K2C 3H4
 TEL: (613) 226-5772
 FAX: (613) 226-2802

Fax Ref No: 10540 From: Avtech Electrosystems Ltd.
 To: Harris Semiconductor, Our Fax No: (613) 226-2802
NC Date: February 2, 1995
 Attn: Tom Jochum Receivers Fax No: 919-405-3651
Tel: 919-405-3623
 Subject: AVR-B3-C-HS1 No. of pages: 1

- 1) Following my quotation of January 23rd and our telephone conversation of February 1st, this will confirm that we can provide a dual polarity option for the above special model. To specify the dual polarity option, add the suffix -PN to the model number and add \$1,387.00 US to the price. With the -PN option, we supply one 3.9" x 8.5" x 14.8" mainframe and two 1.7" x 2.6" x 4.3" output modules (one positive and one negative). The desired polarity module is connected to the mainframe and a front panel polarity switch is placed in the corresponding polarity position to activate the module.
- 2) Unfortunately, the output amplitude cannot be increased above 100 Volts and we cannot provide a variable rise time option for this model.

Rgds

Dr. Walter Chudobiak
 Chief Engineer

WC:pr

BACK

-P-P6

155
HEAT SINK
ADHESIVE*

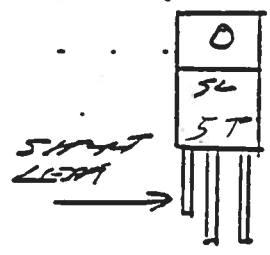
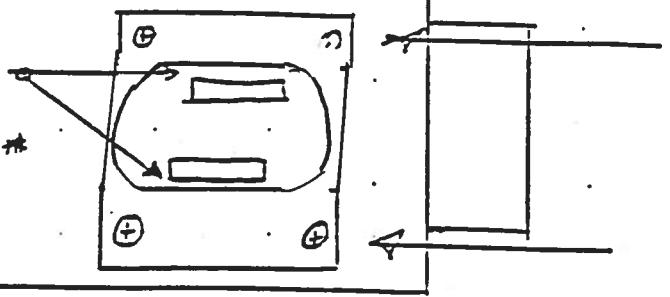

BACK

-N-P6

155 HEAT
SINK
ADHESIVE*

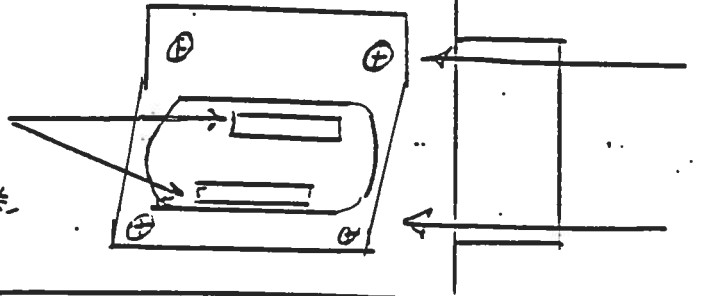

*
CAREFUL INSURE THAT
TRAYS OF 5L5T
D NOT CONTACT
155. EMPS.

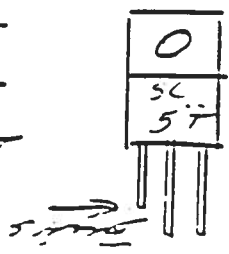

July 20/95

-EW

Disk: AVR-B3

-EA

Name: B3CPNHS1.INS